



# Catálogo 2011

## Poleas, Tensores y Kits

Incluye kits con bomba de agua

CPTK0611MX





**Evite averías costosas del motor.  
Revise la transmisión para accesorios de  
forma completa.**



**Óxido  
y Grietas**



**Ruido**



**Oscilación  
excesiva  
del brazo  
del tensor**



**Movimiento  
Rígido ó  
chirriante  
del brazo**



**Desalineación  
del tensor**



**Desalineación  
del brazo del  
tensor**

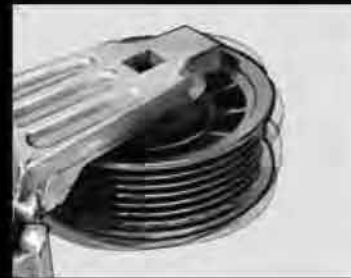

**Desgaste del  
rodamiento  
de la polea  
del tensor**

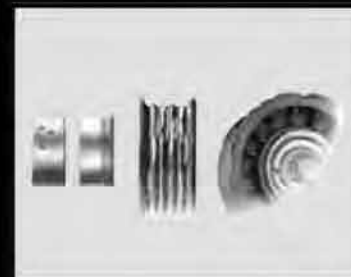

**Desgaste de la  
polea**

***Si observa algunos de estos signos de desgaste, reemplace la banda por una banda Micro-V® AT***



***Abrasión***

***Grietas***

***Desgaste desigual***

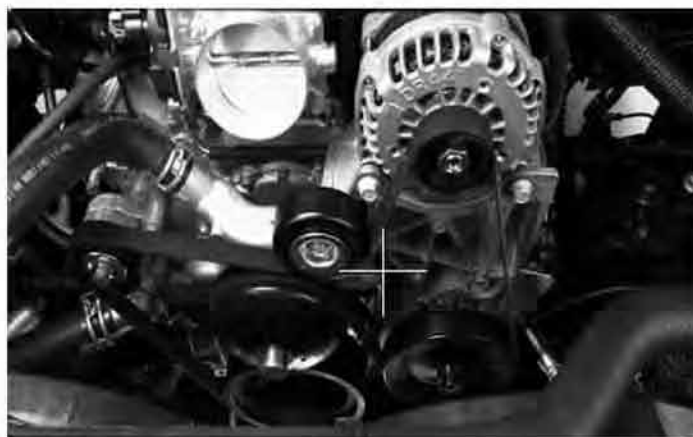

***Si el tensor no funciona correctamente reemplacelo por un tensor Drivealign® de Gates***

***La marca de más prestigio en bandas, mangueras, hidráulica y neumática***





<b>INDICE</b>	
<b>CARACTERÍSTICAS Y ESPECIFICACIONES</b>	
KITS PARA BANDA DE TIEMPO	III
KITS PARA BANDA MICRO-V®	III
DRIVE ALIGN® – TENSORES AUTOMÁTICOS PARA BANDAS MICRO-V®	III
TENSORES AUTOMÁTICOS Y POLEAS PARA BANDAS DE TIEMPO	IV
TENSORES HIDRÁULICOS	VI
<b>FORMAS Y DIMENSIONES</b>	
GUÍA DE POLEAS DRIVEALIGN®	VII
GUÍA DE TENSORES PARA DRIVEALIGN® Y POWERGRIP®	XI
TABLAS DE APLICACIONES DE KITS PARA BANDAS MICRO-V®	XXII
TABLA DE APLICACIONES DE KITS PARA POWERGRIP®	XXIX
APLICACIÓN POR ARMADORA	
<b>ACURA</b>	<b>1</b>
CL	
EL	
INTEGRA	
LEYEND	
MDX	
ERDX	
RL	
SLX	
TL	
TSX	
VIGOR	
<b>AUDI</b>	<b>3</b>
A3	
A4	
A6	
A8	
A8 QUATTRO	
ALLROAD QUATTRO	
CABRIOLET	
Q5	
Q7	
S4	

S4 QUATTRO	
S8	
TT	
<b>BMW</b>	<b>5</b>
318I	
318IS	
318TI	
320TI	
323I	
325	
325CI	
325E	
325I	
325IS	
325IX	
325XI	
328I	
330CI	
330XI	
525I	
528E	
528I	
530I	
540I	
545I	
740I	
740IL	
745I	
745LI	
750IL	
760I	
760LI	
840CI	
850CI	
850CSI	
850I	
M3	
M5	
X3	
X5	
Z3	
Z4	
<b>BUICK</b>	<b>8</b>
CENTURY	
ELECTRA	
ENCALVE	
LACROSSE	
LESABRE	
REATTA	

REGAL	
RIVIERA	
SKYHAWK	
<b>CADILLAC</b>	<b>9</b>
ALLANTE	
CATERA	
CTS	
DEVILLE	
DTS	
EL DORADO	
ESCALADE	
FLEETWOOD	
REGAL	
SEVILLE	
SIXTY SPECIAL	
SRX	
STS	
XLR	
<b>CHEVROLET</b>	<b>11</b>
ASTRA	
ASTRO	
AVALANCHE	
AVEO	
BLAZER	
BLAZER COMPACT	
BLAZER FULL SIZE	
C Y K SERIES PICKUP	
C Y K SERIES PICKUP C-30	
C-20	
C-2500	
C-30	
C-35	
C-3500	
CAMARO	
CAMARO Z28	
CAPRICE	
CAPTIVA	
CAVALIER	
CAVALIER Z24	
CELEBRITY	
CENTURY	
COLORADO	
CORSA	
CORVETTE	
CRUISE	
CUTLASS	
CHEVY	
CHEVY C2	
CHEVY C2 SEDAN	



CHEVY JOY	
CHEVY PICK- UP	
CHEVY POP	
CHEVY SWING	
CUTLASS EUROSPO	
EIGHTY EIGHT	
EPICA	
EQUINOX	
EXPRESS	
EXPRESS CARGO VAN	
G SERIES VAN	
G20 CHEVY VAN	
G30 CHEVY VAN	
HHR	
IMPALA	
IMPALA SS	
LUMINA	
LUMINA APV	
MALIBU	
MATIZ	
MERIVA	
METRO	
MONTE CARLO	
MONZA	
NOVA	
OPTRA	
P SERIES VAN	
P31 VANETTE	
PICKUP 1500	
REGAL	
S SERIES PICKUP	
S-10	
SILVERADO	
SILVERADO 1500	
SILVERADO 2500	
SILVERADO 2500 4X4	
SILVERADO 3500 HD	
SILVERDADO PICKUP	
SILVERADO PICKUP 1500	
SPECTRUM	
SPRINT	
SSR	
SUBURBAN	
TAHOE	
TIGRA	
TORNADO	
TRACKER	
TRAILBLAZER	
TRAVERSE	
UPLANDER	

VECTRA	
VENTURE	
ZAFIRA	
<b>CHRYSLER</b>	<b>25</b>
300	
300 C	
300 M	
ASPEN	
CIRRUS	
CONCORDE	
CORDOBA	
CROSSFIRE	
DAYTONA	
E CLASS	
EXECUTIVE	
FIFTH AVENUE	
GRAND VOYAGER	
INTREPID	
LASER	
LEBARON	
LHS	
NEON	
NEW YORKER	
PACIFICA	
PT CRUISER	
RAMPAGE	
SEBRING	
TOWN & COUNTRY	
VOYAGER	
VOYAGER TOWN N COUNTR	
<b>DAEWOO</b>	<b>29</b>
LEGANZA	
NUBIRA	
<b>DAIHATSU</b>	<b>29</b>
CHARADE	
ROCKY	
<b>DODGE</b>	<b>30</b>
200 GTX	
400	
600	
ADVENTURER	
ARIES	
AVENGER	
B SERIES VAN	
CALIBER	
CARAVAN	
COLT	
CHARGER	

<b>D &amp; W SERIES PICKUP</b>	
D-150	
D-250	
D-350	
DAKOTA	
DIPLOMAT	
DURANGO	
EXPO	
GRAND CARAVAN	
INTREPID	
JOURNEY	
LANCER	
MAGNUM	
MINI RAM VAN	
NEON	
NITRO	
OMNI	
RAM 1500	
RAM 2500	
RAM 3500	
RAM 4000	
RAM 50 PICKUP	
RAM CHARGER	
RAM MAXI VAN 1500	
RAM MAXI VAN 2500	
RAM MAXI VAN 3500	
RAM MAXI WAGON 3500	
RAM SERIES PICKUP	
RAM WAGON 1500	
RAM WAGON 2500	
RAM WAGON 3500	
RAMPAGE	
SEBRING	
SHADOW	
SPIRIT	
STEALTH	
STRATUS	
VIPER	
<b>EAGLE</b>	<b>39</b>
2000 GTX	
SUMMIT	
TALON	
VISTA	
<b>FIAT</b>	<b>39</b>
BRAVO	
DUCATO	
GRANDE PUNTO	
PALIO	
PALIO ADVENTURE	



<b>FORD</b>	<b>40</b>
AEROSTAR	
ASPIRE	
BRONCO	
BRONCO FULL SIZE	
CONTOUR	
COUGAR	
CROWN VICTORIA	
E SERIES VAN	
ECOSPORT	
EDGE	
ESCAPE	
ESCORT	
EXCURSION	
EXPEDITION	
EXPLORER	
EXPLORER SPORT TRAC	
F SERIES PICKUP	
F-150	
F-250	
F-250 LOBO	
F-250 SUPER DUTY	
F-350 SUPER DUTY	
F-450 SUPER DUTY	
F-550 SUPER DUTY	
FAIRMONT	
FALCON	
FESTIVA	
FIESTA	
FIVE HUNDRED	
FOCUS	
FREESTAR	
FUSION	
GRANADA	
GT	
IKON	
KA	
LOBO	
LTD	
MONDEO	
MUSTANG	
MUSTANG SHELBY	
PINTO	
PROBE	
RANGER	
SUPER DUTY PICKUP	
SUPER DUTY VAN	
TAURUS	
TEMPO	
THUNDERBIRD	

TOPAZ	
TORINO	
TRANSIT	
WINDSTAR	
ZX2	
<b>GEO</b>	<b>54</b>
METRO	
PRIZM	
STORM	
TRACKER	
<b>GMC</b>	<b>54</b>
ACADIA	
C Y K SERIES PICKUP	
CANYON	
SIERRA	
ENVOY	
JIMMY	
SAFARI	
SAVANA	
SONOMA	
YUKON	
<b>HONDA</b>	<b>55</b>
ACCORD	
CIVIC	
CIVIC DEL SOL	
CIVIC HIBRIDO	
CR-V	
CR-X	
ELEMENT	
ODYSSEY	
PASSPORT	
PILOT	
PRELUDE	
RIDGELINE	
<b>HUMMER</b>	<b>58</b>
H1	
H2	
H3	
<b>HYUNDAI</b>	<b>59</b>
ACCENT	
ATOS	
ATTITUD	
ANTRA	
EXCEL	
H100	
H100 VAN/WAGON	
SANTA FE	
ESCOPE	

SONATA	
TIBURON	
TUCSON	
VERNA	
<b>ISUZU</b>	<b>61</b>
AMIGO	
I-MARK	
IMPULSE	
OASIS	
PICK-UP	
RODEO	
STYLUS	
TROOPER	
TROOPER II	
<b>JAGUAR</b>	<b>62</b>
S-TYPE	
<b>JEEP</b>	<b>63</b>
COMMANDER	
COMPASS	
CHEROKEE	
GRAND CHEROKEE	
LIBERTY	
PATRIOT	
TJ	
WRANGLER	
<b>KIA</b>	<b>65</b>
MAGENTIS	
OPTIMA	
SEPHIA	
SPECTRA	
SPORTAGE	
<b>LAND ROVER</b>	<b>66</b>
DISCOVERY	
DISCOVERY SERIES II	
RANGE ROVER	
<b>LEXUS</b>	<b>66</b>
ES250	
ES300	
GS300	
IS300	
SC300	
<b>LINCOLN</b>	<b>66</b>
AVIATOR	
CONTINENTAL	
LS	
MARK III	
MARK IV	



MARK LT	
MARK VIII	
MKX	
MKZ	
NAVIGATOR	
TOWN CAR	
<b>MAZDA</b>	<b>68</b>
323	
626	
929	
B2000 PICKUP	
B2200 PICKUP	
CX-7	
CX-9	
MAZDA 3	
MAZDA 5	
MAZDA 6	
MILLENNIA	
MPV	
MX-3	
MX-5 MIATA	
MX-6	
PROTEGE	
TRIBUTE	
<b>MERCEDES BENZ</b>	<b>70</b>
190D	
190E	
260E	
300CE	
300E	
300SE	
300SEL	
300SL	
300TE	
500SL	
C240	
C280	
C320	
CL500	
CL55	
CLK320	
CLK430	
CLK500	
CLK55	
E320	
E430	
E55	
ML320	

S320	
S430	
S500	
S55	
SL500	
SL55	
SL600	
SLK230	
SLK320	
SLK350	
SPRINTER	
VITO	
<b>MERCURY</b>	<b>74</b>
CAPRI	
COMET	
COUGAR	
COUGAR XR7	
GRAND MARQUIS	
MARINER	
MILAN	
MONARCH	
MONTEGO	
MOUNTAINEER	
MYSTIQUE	
SABLE / TAURUS	
TRACER	
<b>MINI</b>	<b>76</b>
COOPER	
<b>MITSUBISHI</b>	<b>76</b>
3000 GT	
DIAMANTE	
ECLIPSE	
ENDEAVOR	
GALANT	
GRANDIS	
LANCER	
MIRAGE	
MONTERO	
MONTERO SPORT	
OUTLANDER	
PICK-UP	
PRECIS	
VAN	
<b>NISSAN</b>	<b>78</b>
200SX	
300ZX	
370Z	
ALTIMA	

APRIO	
ARMADA	
FRONTIER	
MAXIMA	
MURANO	
PATHFINDER	
PICK-UP	
PLATINA	
PULSAR NX	
QUEST	
SENTRA	
STANZA	
TITAN	
TSURU	
XTERRA	
<b>OLDSMOBILE</b>	<b>81</b>
ACHIEVA	
AURORA	
CUTLASS	
CUTLASS CIERRA	
CUTLASS CUISER	
CUTLASS SUPREME	
EIGHTY EIGHT	
FIRENZA	
INTRIGUE	
NINETY EIGHT	
SILHOUETTE	
TORONADO	
<b>PEUGEOT</b>	<b>82</b>
206	
207	
307	
GRAND RIDE	
PARTNER	
<b>PLYMOUTH</b>	<b>82</b>
BREEZE	
CARAVELLE	
COLT	
GRAN FURY	
HORIZON	
LASER	
NEON	
RELIANT	
SUNDANCE	
VOYAGER	
<b>PONTIAC</b>	<b>83</b>
AZTEK	
BONNEVILLE	



FIREBIRD TRANS AM	
FIREFLY	
G3	
G4	
G5	
G6	
G8	
GRAND AM	
GRAND PRIX	
LEMANS	
MATIZ G2	
MONTANA	
SOLSTICE	
SUNBIRD	
SUNBURST	
SUNFIRE	
TORRENT	
<b>PORSCHE</b>	<b>86</b>
911	
BOXSTER	
<b>RENAULT</b>	<b>86</b>
CLIO	
EUROCLIO	
KANGOO	
KANGOO EXPRESS	
LAGUNA	
MEGANE	
SANDERO	
SCENIC	
STEPWAY	
TRAFIC	
<b>SAAB</b>	<b>88</b>
9-3	
9-5	
9000	
<b>SATURN</b>	<b>89</b>
L-SERIES	
S-SERIES	
VUE	
AURA	
ION	
RELAY	
SKY	
<b>SEAT</b>	<b>90</b>
ALHAMBRA	
ALTEA	
CORDOBA	
IBIZA	

LEON	
TOLEDO	
<b>SUBARU</b>	<b>91</b>
BAJA	
DL	
FORESTER	
GLI	
GL10	
IMPRESZA	
JUSTY	
LEGACY	
LOYALE	
OUTBACK	
RX	
SVX	
XT	
<b>SUZUKI</b>	<b>93</b>
AERIO	
FORENZA	
GRAND VITARA	
RENO	
SIDEKICK	
SWIFT	
SX4	
VITARA	
X-90	
XL-7	
<b>TOYOTA</b>	<b>94</b>
4 RUNNER	
AVALON	
CAMRY	
CAMRY SOLARA	
CELICA	
COROLLA	
CRESSIDA	
FJ CRUISER	
HIGHLANDER	
LAND CRUISER	
MATRIX	
MR2	
PASEO	
PICK-UP	
RAV 4	
SEQUOIA	
SIENNA	
SOLARA	
SUPRA	
T100	
TACOMA	

TERCEL	
TUNDRA	
<b>VOLKSWAGEN</b>	<b>99</b>
BEETLE	
BORA	
BORA SPORTWAGEN	
CABRIO	
CRAFTER	
CROSSFOX	
DASHER	
DERBY	
EUROVAN	
GLI	
GOL	
GOLF	
GTI	
JETTA	
LUPO	
PANEL	
PASSAT	
POINTER	
POINTER PICK-UP	
POLO	
QUANTUM	
RABBIT	
RABBIT PICK-UP	
ROUTAN	
SAVEIRO	
SHARAN	
SPORTVAN	
TOUAREG	
VANAGON	
VW VAN	
<b>VOLVO</b>	<b>106</b>
240	
260	
740	
760	
780	
850	
940	
960	
C30	
C70	
S40	
S60	
S70	
S80	
V40	





V50	
V70	
XC-70	
XC90	
SERVICIO PESADO	
<b>BLUEBIRD</b>	<b>110</b>
ALL AMERICAN FE	
ALL AMERICAN RE	
CONVENTIONAL	
MINI BIRD	
TC2000	
VISION	
<b>CHEVROLET</b>	<b>110</b>
C4500	
C5500	
C6500	
C7500	
C8500	
KODIAK	
KODIAK C6500	
KODIAK C7500	
KODIAK C8500	
T6500	
T7500	
T8500	
W3500	
W4500	
<b>DINA</b>	<b>114</b>
102 F	
104 - R	
104 - SF	
94 F	
<b>FORD</b>	<b>114</b>
E450 SUPER DUTY	
E550 SUPER DUTY	
F SUPER DUTY	
F450 SUPER DUTY	
F550 SUPER DUTY	
F600	
F650 SUPER DUTY	
F750 SUPER DUTY	
F800	
<b>FREIGHTLINER</b>	<b>116</b>
ARGOSY	
BUSINESS CLASS M2	
CASCADIA	
CENTURY CLASS	
CLASSIC	

CLASSIC XL	
COLUMBIA	
CONDOR	
CORONADO	
FC70	
FC80	
FL112	
FL50	
FL60	
FL70	
FL80	
FLD	
FLD120	
<b>INTERNATIONAL / NAVISTAR</b>	<b>127</b>
3300	
3800	
4100	
4200	
4300	
4400	
4600	
4700	
4700 FBC	
4700 SCD	
4800	
4900	
5000	
5500	
5500i	
5600	
5600i	
5900i	
7100	
7300	
7400	
7500	
7600	
7700	
8100	
8200	
8500	
8600	
9100	
9100i	
9200	
9200i	
9300	
9400	

9400i	
9600	
9700	
9800	
9900	
9900i	
9900ix	
BE	
CE	
CONVENCIONAL IC	
CXT	
DURASTAR 4300	
FE	
PAYSTAR 5500i	
PAYSTAR 5600i	
PAYSTAR 5900i	
PROSTAR SERIES	
RE	
RXT	
TRANSTAR 8500	
TRANSTAR 8600	
WORKSTAR 7600	
WORKSTAR 7700	
<b>KENWORTH</b>	<b>136</b>
T2000	
T300	
T600	
T660	
T800	
T800B AEROCAB	
T800SH AEROCAB	
W900	
<b>MACK</b>	<b>139</b>
CHN SERIES	
CL SERIES	
CS SERIES	
CT SERIES	
CTP SERIES	
CV SERIES	
CX SERIES	
CXN SERIES	
CXP SERIES	
CH SERIES	
CHN SERIES	
DM SERIES	
LE SERIES	
MR SERIES	
RD SERIES	
PETERBILT	



320	
330	
335	
357	
362	
365	
367	
377	
378	
379	
385	
386	
387	
388	
389	
STERLING	
ACTERRA	
A - LINE	
L - LINE	
THOMAS BUILT	

CONVENTIONAL	
MINOTOUR	
SAF - T - LINER C2	
SAF - T- LINER MVP EF	
SAF - T- LINER MVP ER	
<b>VOLKSWAGEN</b>	<b>147</b>
15 - 190 WORKER	
17 - 210 VOLKSBUS	
17 - 250 WORKER	
24 - 250 WORKER	
8 - 150 VOLKSBUS	
8 - 150 WORKER	
<b>VOLVO</b>	<b>148</b>
7550	
7550 FL	
9700	
9700 FL	
AUTOCAR	
VHD	

VN SERIES	
VNL	
VNL 64T 420	
VNL 64T 420 6X4 TIPICO	
VNL 64T 420 STANDAR	
VNL 64T 610	
VNM	
VT SERIES	
WG SERIES	
APLICACIÓN POR PRODUCTO	<b>150</b>
TENSORES Y POLEAS AUTOMOTRIZ	
TENSORES Y POLEAS SERVICIO PESADO	
TABLA DE EQUIVALENCIAS	<b>313</b>

## **“Premio Nacional a la Calidad Automotriz 2010”**



**Los Profesionales prefieren productos Gates**

# Visita nuestra página en Internet para consultar información actualizada!

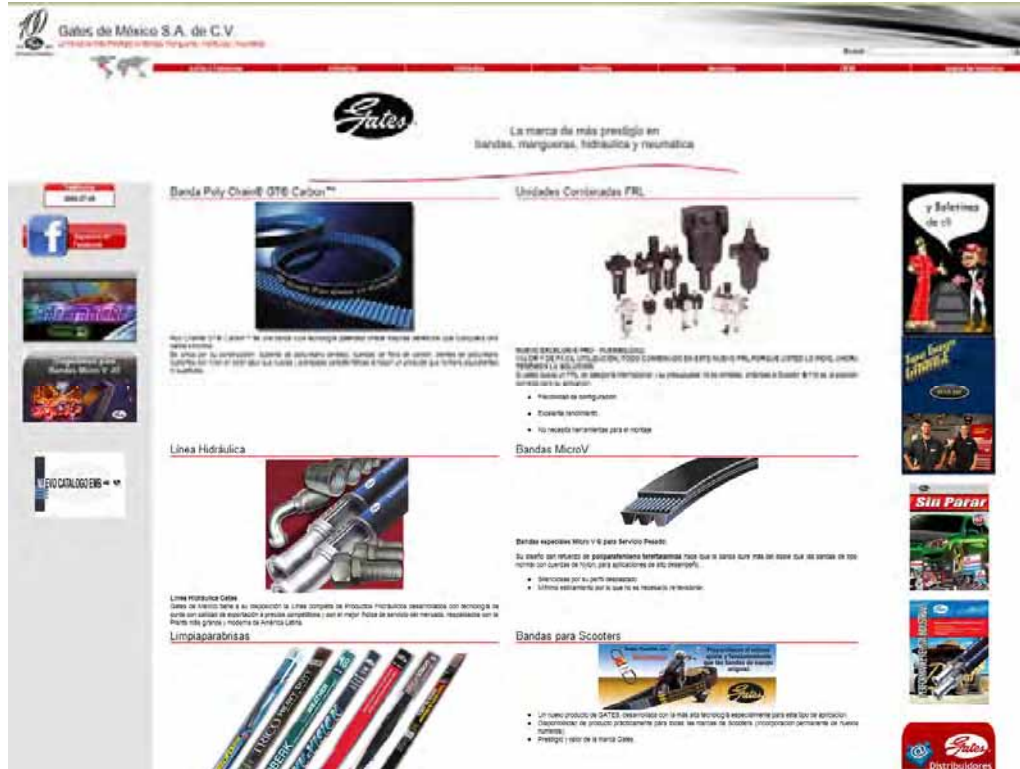

En nuestro sitio WEB podrás consultar todas las características y especificaciones de nuestros productos, así mismo, podrás descargar los catálogos vigentes, Revistas "Sin Parar" y Boletines en formato electrónico.

También podrás navegar a los diferentes sitios de Gates a nivel mundial, en donde tendrás la oportunidad de consultar todos los productos Gates que aplican para un auto en específico, a través, de las siguientes direcciones:

# <http://www.gates.com.mx>



Búscanos como Gates de México

**GATES: LA MARCA DE MÁS PRESTIGIO EN BANDAS, MANGUERAS, HIDRÁULICA Y NEUMÁTICA.**

## Productos Gates \* Características y especificaciones

### Kits para bandas de Tiempo (árbol de levas)

Los kits PowerGrip® de Gates te proporcionan una solución completa para el sistema de sincronización de tu automóvil.

Con los kits para bandas de tiempo Gates, no tendrás que comprar los componentes (Banda, Tensores, poleas y tornillos) por separado, los encontrarás en un sólo kit con la garantía de que siempre estarás haciendo el reemplazo de estas piezas con las mismas características del equipo original.

Cada kit incluye todos los componentes para una aplicación en específico:

- Banda Timing
- Polea Tensora
- Polea loca
- Instrucciones de instalación



**Nuevo**

### Kits para bandas Micro-V® (Serpentín)

Con el nuevo kit para bandas Micro-V® AT, Gates ofrece al mercado todos los componentes necesarios para garantizar un reemplazo completo de la transmisión para accesorios en un sólo kit. Ya no hace falta pedir piezas separadas: los componentes metálicos y las bandas Micro-V® AT vienen en una sola caja, listos para ser instalados.

¡Ahorro de tiempo y comodidad en un sólo kit!

Los kit para bandas Micro-V® incluyen:

- 1 ó 2 Bandas Micro-V® AT
- 1 ó 2 Tensores DriveAlign® de resorte helicoidal
- Las poleas guías necesarias
- Instrucciones de instalación

Nomenclatura: DBKxxxxyy



### DriveAlign® - Tensores automáticos para bandas Micro-V®

Los tensores automáticos DriveAlign® de Gates exceden las especificaciones de equipo original y están disponibles para las principales marcas de autos a nivel mundial.

Los tensores DriveAlign® de Gates le ofrecen:

- Mejoran la vida útil de las Bandas Micro-V® AT
- Aumentan la vida útil de los accesorios
- Reducen costos de mantenimiento
- **Eliminan el ruido de la transmisión**

**GATES: LA MARCA DE MÁS PRESTIGIO EN BANDAS, MANGUERAS,  
HIDRÁULICA Y NEUMÁTICA.**



## BANDAS MICRO-V® STRETCH FIT™

Cada vez más los fabricantes de automóviles comercializan vehículos que no están equipados con un dispositivo de tensado para la transmisión de los accesorios. Las bandas **Stretch Fit™** son la respuesta ideal para estas aplicaciones especiales. Están pretensadas sobre las poleas, manteniendo la tensión suficiente para una transmisión de potencia eficiente durante un largo período de tiempo, pero también lo suficientemente baja para permitir la instalación fácil y evitar fallas en los demás componentes del motor.

### Características técnicas:

Bandas de alta tecnología diseñadas para el Equipo Original, usan un refuerzo especial en las cuerda **TwistLock™** que permite mantener una tensión adecuada durante toda la vida de la banda.



### Recomendaciones para su Instalación:

Cada aplicación tiene instrucciones de instalación únicas. Las instrucciones se muestran en el interior de la Fajilla de cada banda. Es muy importante que estas instrucciones se sigan al pie de la letra para no causar daños a la banda en el momento de su instalación.

Aquí se muestran gráficamente algunos procesos para la instalación de estas bandas:



**Nota Importante:** Se requiere de la longitud específica para cada aplicación, es decir, no existen intercambios con otras bandas Micro-V estándar.

Es necesario contar con una herramienta especial para la instalación de las bandas **Micro-V® Stretch Fit™**, esta herramienta es comercializada por Gates de México, con la siguiente identificación de producto (**No. Parte: 91030**)



No. Parte 91030

**GATES: LA MARCA DE MÁS PRESTIGIO EN BANDAS, MANGUERAS, HIDRÁULICA Y NEUMÁTICA.**

## Productos Gates \* Características y especificaciones

### Lista de principales aplicaciones con parque vehicular en México:

Código	Banda	Años	Marca	Modelo	Motor
85560009	K040355 SF	2009-10	Cadillac	Escalade	6.2 Lts
		2009-10	Chevrolet	Express / Suburban / Silverado / Tahoe	4.8 Lts. / 5.3 Lts.
		2009-10	GMC	Savana / Yukon / Sierra / Avalanche	5.3 Lts. / 6.0 Lts.
		2009-10	Hummer	H2 / H3	5.3 Lts. / 6.2 Lts.
85560002	K040374 SF	2007-09	Dodge	Nitro	4.0 Lts.
85560000	K040352 SF	2007-09	Ford	Edge	3.5 Lts.
		2010 +	Ford	Fusion	3.5 Lts.
85560001	K040362 SF	2008-10	Dodge	Avenger	2.7 Lts.
		2008-10	Ford	Transit	2.2 Lts TDI
85560006	K030195 SF	2006-09	Ford	Fusion	3.0 Lts.
		2006-08	Ford	Escape	3.0 Lts.
		2006-08	Lincoln	Zephyr	3.0 Lts.
		2006-08	Mercury	Milan / Mariner	3.0 Lts.
74680016	91030	MicroV Strech Fit herramienta de instalación			

**Próximamente bandas Micro-V Stretch Fit™ para SAVEIRO y GOL**

**GATES: LA MARCA DE MÁS PRESTIGIO EN BANDAS, MANGUERAS,  
HIDRÁULICA Y NEUMÁTICA.**

Nuevo

## KITS PowerGrip® TCK's CON BOMBA DE AGUA



Un mal funcionamiento del sistema de transmisión por banda de distribución puede causar graves problemas. Por eso, cuando la bomba de agua y otros componentes fallan afectan directamente a la banda de distribución, por esta razón **Gates recomienda el reemplazo completo de todos los elementos de la transmisión (Banda Timing, Tensor, Poleas y Bomba de agua)**. La extensa gama de kits PowerGrip® de Gates le permite ofrecer a sus clientes un sistema de transmisión completo con **Calidad de Equipo Original**.

La bomba de agua es un componente vital del sistema de refrigeración del vehículo. Asegura un flujo continuo de líquido refrigerante a través del radiador y del motor. Las bombas de agua modernas se accionan por la banda de distribución.

Cuando la bomba de agua falla, el líquido refrigerante se filtra sobre la banda de distribución. Una contaminación prolongada de líquido refrigerante causará finalmente la ruptura de la banda de distribución.

Código	Descripción	Años	Aplicación	No. Comp.
77820329	TCKWP139	1987-2000	Dodge Caravan 3.0L / Hyundai Sonata 3.0L	3
77820330	TCKWP143	1988-1995	Honda Civic 1.5L	3
77820362	TCKWP157	1988-1991	Toyota Camry 2.5L	4
77820361	TCKWP163	1990-1994	Pontiac Sunbird 2.0L	3
77820360	TCKWP172	1990-1993	Subaru Legacy 2.2L	6
77820331	TCKWP184	1997-2001	Honda CR-V 2.0L	3
77820332	TCKWP184A	1990-1995	Acura Integra 1.8L	3
77820333	TCKWP186	1990-1997	Honda Accord / Prelude / Odyssey 2.2L	5
77820349	TCKWP193	1991-1995	Acura Legend 3.2L	3
77820350	TCKWP193A	1996-1998	Acura TL 3.2L	3
77820363	TCKWP194	1991-1996	Ford Escort 1.9L	3
77820364	TCKWP195	1991-1999	Mitsubishi 3000GT 3.0L	4
77820334	TCKWP199	1990-2001	Toyota Camry Celica Rav 4 MR2 2.0 2.2L	4
77820365	TCKWP200	1992-1993	Toyota Camry 3.0L	4
77820366	TCKWP211	1995-1998	Acura TL 2.5L	3
77820367	TCKWP211A	1992-1994	Acura Vigor 2.5L	3
77820368	TCKWP216	1992-1996	Honda Prelude 2.3L	5
77820369	TCKWP219	1993-1994	Dodge Intrepid 3.5L	3
77820335	TCKWP221	1994-1997	Honda Passport 3.2L   Izuzu Trooper 3.2L	4
77820336	TCKWP224	1996-2000	Honda Civic 1.6L	3
77820337	TCKWP224A	1992-199	Honda Civic 1.6L	3
77820374	TCKWP240	1993-1995	Toyota 4 Runner 3.0L	4

**GATES: LA MARCA DE MÁS PRESTIGIO EN BANDAS, MANGUERAS, HIDRÁULICA Y NEUMÁTICA.**

## Productos Gates \* Características y especificaciones

Código	Descripción	Años	Aplicación	No. Comp.
77820375	TCKWP240B	1994-1995	Toyota Pickup 3.0L	4
77820376	TCKWP240C	1989-1992	Toyota 4 Runner 3.0L	4
77820338	TCKWP244	1998-2002	Honda Accord 2.3L	5
77820339	TCKWP245	1995-1998	Dodge Neon Stratus 2.0L	3
77820340	TCKWP245A	1996-2005	Dodge Neon Stratus 2.0L	3
77820341	TCKWP245B	1996-2005	Dodge Neon Stratus 2.0L	3
77820342	TCKWP246	1995-1999	Chrysler Sebring 2.0L   Mitsubishi Eclipse 2.0L	4
77820377	TCKWP259	2001-2005	Dodge Sebring Stratus 3.0L   Mistubishi Eclipse 2.0L	4
77820378	TCKWP259A	1995-2000	Chrysler Cirrus Sebring 2.5L	4
77820343	TCKWP263	1995-1997	Honda Accord 2.7L	3
77820344	TCKWP265	2003-2008	Chrysler PT Cruiser 2.4L   Jeep Liberty Wrangler 2.4L	4
77820345	TCKWP265A	2003-2008	Chrysler PT Cruiser 2.4L   Jeep Liberty Wrangler 2.4L	4
77820346	TCKWP265B	1997-2002	Dodge Stratus Caravan 2.4L	4
77820347	TCKWP265C	2003-2006	Dodge Neon 2.4L	4
77820370	TCKWP279	1996-2003	Acura RL 3.5L	5
77820348	TCKWP281	1995-2002	Kia Sportage 2.0L	4
77820351	TCKWP283	2000-2004	Ford Focus 2.0L	3
77820352	TCKWP283A	1997-2002	Ford Escort 2.0L	3
77820379	TCKWP287	2003-2004	Mitsubishi Diamante Montero Sport 3.5L	4
77820353	TCKWP296	1998-2004	Volkswagen Golf Jetta Beetle 2.0L	3
77820354	TCKWP297	1998-2005	Volkswagen Passat 2.8L	5
77820371	TCKWP297A	2000-2004	Audi A6 4.2L	6
77820372	TCKWP297B	2002-2005	Audi Allroad Quattro 2.7L	5
77820355	TCKWP306	1999-2005	Volkswagen Golf Jetta Passat Beetle 1.8L	5
77820356	TCKWP306A	1999-2006	Audi A4 1.8L	5
77820357	TCKWP321	1998-2004	Volkswagen Golf Jetta Beetle 1.9L Diesel	6
77820358	TCKWP329	2003-2007	Honda Accord 3.0L	5
77820359	TCKWP331	1998-2007	Volvo V70 2.4L	4
	TCKWP203	2004-2010	Chevrolet Chevy 1.4L	3
	TCKWP077	2010-1981	Nissan Tsuru 1.6L 8 Valvulas	3
	TCKWP260	2008-1998	Volkswagen Pointer 1.8 L	3

**GATES: LA MARCA DE MÁS PRESTIGIO EN BANDAS, MANGUERAS,  
HIDRÁULICA Y NEUMÁTICA.**



## Productos Gates \* Características y especificaciones

### Kits para bandas de Tiempo (árbol de levas)

Los kits PowerGrip® de Gates te proporcionan una solución completa para el sistema de sincronización de tu automóvil.

Con los kits para bandas de tiempo Gates, no tendrás que comprar los componentes (Banda, Tensores, poleas y tornillos) por separado, los encontrarás en un sólo kit con la garantía de que siempre estarás haciendo el reemplazo de estas piezas con las mismas características del equipo original.

Cada kit incluye todos los componentes para una aplicación en específico:

- Banda Timing
- Polea Tensora
- Polea loca
- Instrucciones de instalación



**Nuevo**

### Kits para bandas Micro-V® (Serpentín)

Con el nuevo kit para bandas Micro-V® AT, Gates ofrece al mercado todos los componentes necesarios para garantizar un reemplazo completo de la transmisión para accesorios en un sólo kit. Ya no hace falta pedir piezas separadas: los componentes metálicos y las bandas Micro-V® AT vienen en una sola caja, listos para ser instalados.

¡Ahorro de tiempo y comodidad en un sólo kit!

Los kit para bandas Micro-V® incluyen:

- 1 ó 2 Bandas Micro-V® AT
- 1 ó 2 Tensores DriveAlign® de resorte helicoidal
- Las poleas guías necesarias
- Instrucciones de instalación

Nomenclatura: DBKxxxxyy



**GATES: LA MARCA DE MÁS PRESTIGIO EN BANDAS, MANGUERAS,  
HIDRÁULICA Y NEUMÁTICA.**

## DriveAlign® - Tensores automáticos para bandas Micro-V®

Los tensores automáticos **DriveAlign®** de Gates exceden las especificaciones de equipo original y están disponibles para las principales marcas de autos a nivel mundial.

Los tensores DriveAlign® de Gates le ofrecen:

- Mejoran la vida útil de las Bandas Micro-V® AT
- Aumentan la vida útil de los accesorios
- Reducen costos de mantenimiento
- **Eliminan el ruido de la transmisión**



### ● ¿Qué es un tensor de bandas?

En el caso de Gates, no solamente es un tensor de bandas, es un tensor **automático** de bandas. Y es un dispositivo que permite aplicar fuerza constante a la banda, haciéndola trabajar a la tensión ideal.

### ● ¿Cómo funciona?

El tensor funciona de manera óptima solo si se cumplen los siguientes puntos:

- a) Dimensión correcta de la banda.
- b) Poleas bien alineadas.

**GATES: LA MARCA DE MÁS PRESTIGIO EN BANDAS, MANGUERAS,  
HIDRÁULICA Y NEUMÁTICA.**

## Productos Gates \* Características y especificaciones

Se recomienda hacer el recambio del tensor al mismo tiempo que las bandas y las poleas, esto con el propósito de mantener en óptimo desempeño todos sus componentes. Gates de México, le ofrece **Kits DriveAlign®** para bandas Micro-V® que incluyen el tensor, la banda MICRO-® AT y poleas.

**1. BASE:** Pieza fija del tensor que se acopla al bloque del motor o a otros accesorios. Los diseños de la base varían algunos componentes.

**2. RESORTE:** Precargado de fábrica, permite darle tensión a la banda .

**3. AMORTIGUADOR:** Permite autolubricar las partes internas del tensor.

**4. BRAZO:** Conecta el resorte con la polea del tensor. Generalmente es una cubierta de aluminio.

**5. SELLO:** Previene la contaminación interna.

**6. POLEA:** Puede ser metálico o termoplástico, acanalado o liso. La superficie de la polea se debe revisar constantemente para eliminar residuos que dañen la banda. El componente más importante de la polea es el balero. Para que una polea funcione correctamente, el balero debe ser lubricado correctamente. La causa más frecuente de la falla de la polea es pérdida de lubricación en los baleros. (No reemplace los baleros en una vieja polea).

**7. CUBREPOLVO:** Proteje al balero contra elementos contaminantes.

**8. TORNILLO:** Conecta a la polea con el brazo del tensor.

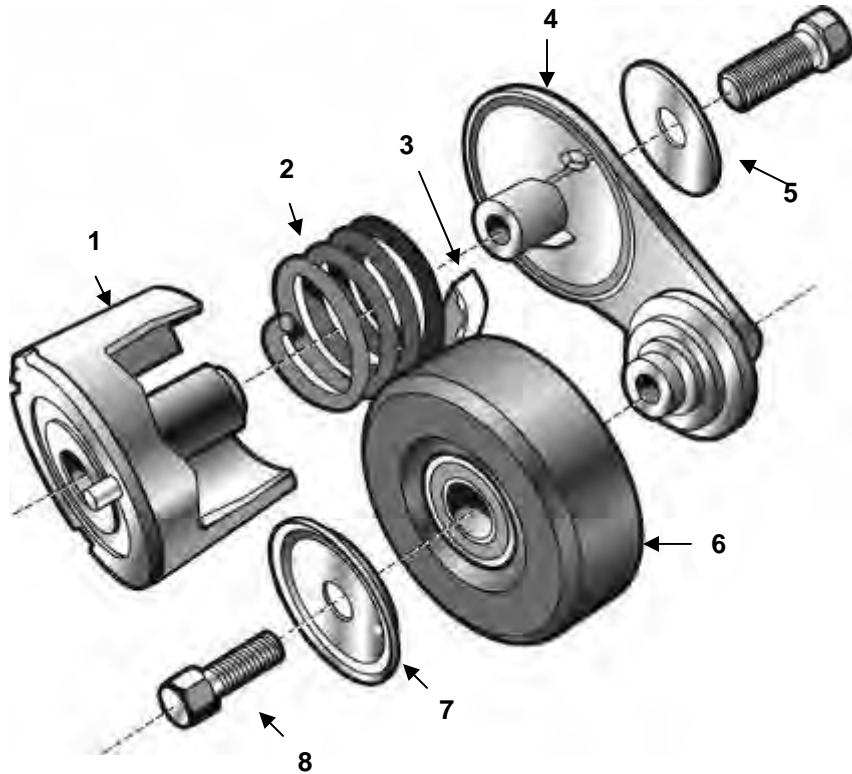

**GATES: LA MARCA DE MÁS PRESTIGIO EN BANDAS, MANGUERAS, HIDRÁULICA Y NEUMÁTICA.**

## Productos Gates \* Características y especificaciones

### Tensores automáticos y Poleas para bandas de Tiempo

Los tensores automáticos PowerGrip® de Gates exceden las especificaciones de EQUIPO ORIGINAL y están disponibles para las principales marcas de autos a nivel mundial.

Los tensores PowerGrip® de Gates le ofrecen:

- Mejoran la vida útil de las Bandas Timing
- Reducen costos de mantenimiento
- Eliminan el ruido en la cabina del conductor



**GATES: LA MARCA DE MÁS PRESTIGIO EN BANDAS, MANGUERAS,  
HIDRÁULICA Y NEUMÁTICA.**

## Productos Gates \* Características y especificaciones

### Componentes de un tensor PowerGrip – para bandas de TIMING

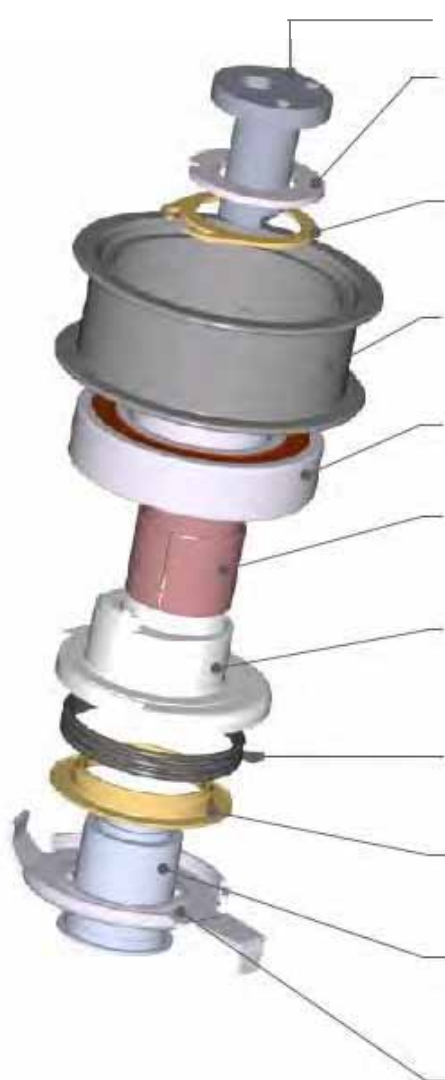

**Eje de instalación:** Asegura que el tensor esté colocado en la posición apropiada del motor cuando está instalado.

**Plato frontal:** Conserva el montaje completo del tensor axialmente. De acuerdo a su diseño mecánico, permite que el tensor no pueda ser desmontado.

**Seguro de lubricación:** Proporciona la alineación y ayuda a lubricar la superficie que resbala sobre el brazo.

**Polea:** Construcción de acero o plástica, dependiendo del uso y/o aplicación.

**Balero:** Sin necesidad de mantenimiento y sellado, proporciona mayor durabilidad. Precisión y construcción de alta temperatura.

**Buje pivote:** Autolubricador, altamente resistente al desgaste - componente de polímero. La función es asegurar la alineación apropiada del brazo del tensor, la inclinación en relación con la banda y de los costados.

**Brazo:** Precisión, componente de aluminio. Transmite el esfuerzo de torsión del resorte a la polea para proporcionar la tensión de la banda en forma constante.

**Resorte:** Pieza crítica del tensor. Su diseño patentado proporciona el control óptimo de la tensión de la banda para cada aplicación.

**Soporte del resorte:** Un diseño de ingeniería; polímetro de alta resistencia al desgaste que proporciona una segunda lubricación y que apoya a la operación sincrónica del tensor.

**Pivote eje:** Mantiene la alineación del brazo y de la polea con relación al motor.

**Plato base:** Asegura la colocación apropiada y la localización angular en el motor.

**GATES: LA MARCA DE MÁS PRESTIGIO EN BANDAS, MANGUERAS, HIDRÁULICA Y NEUMÁTICA.**

Nuevo

### Tensores hidráulicos

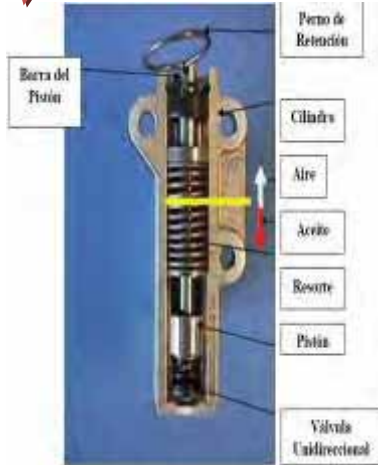

#### ¿Qué es?

El sistema hidráulico es usado principalmente en aplicaciones con vibraciones angulares y/o cargas elevadas, en las cuales un tensor mecánico no puede ofrecer el suficiente desplazamiento. En general el tensor hidráulico necesita más espacio en el motor.

El Tensor Hidráulico consiste en un actuador hidráulico en combinación con una polea. El movimiento de la barra del pistón del actuador es transmitido a la polea del tensor mediante una palanca integrada o separada.

#### ¿Cómo funciona?

El actuador hidráulico trabaja como un amortiguador de choque, donde un resorte en combinación con el aceite, mantiene la rueda en contacto con el asfalto. En este caso, el actuador hidráulico regula la fuerza dinámica de la banda, a la vez que la mantiene en una tensión constante, y compensa los cambios en longitud debidos a expansión térmica.

La barra del pistón se puede mover fácilmente en una dirección debido al aceite que fluye de un lado del pistón hacia el otro, mediante una válvula unidireccional. Las elevadas cargas dinámicas de la banda se regulan mediante el sistema hidráulico, el cual empieza a funcionar a partir del momento en el que el aceite es forzado a fluir entre el pistón y el cilindro.

Este sistema hidráulico se optimiza para cada caso, dependiendo del espacio que se deja entre el pistón, el cilindro y de la viscosidad del aceite.

#### Almacenamiento:

Los actuadores hidráulicos se deben almacenar verticalmente para evitar el escape de aceite y evitar que se mezcle con el aire. La existencia de burbujas de aire en el aceite podría provocar un mal funcionamiento del sistema.

#### Instalación:

El perno de retención sólo debe quitarse después de la instalación de la banda, polea y el actuador.

El motivo de esta recomendación, es que una vez instalado el actuador hidráulico está en una posición vertical, y no hay riesgo de que pueda mezclarse aire en el aceite.

Si el perno se mueve accidentalmente cuando el tensor se encuentra en una posición horizontal, es ALTAMENTE recomendable comprimir la barra del pistón suavemente en posición vertical y posteriormente instalar la pieza. Se deberá dar unas revoluciones manuales al motor con tal de poder separar el aceite y el aire antes de que el motor se encienda.

#### Ventajas:

Debido a que el sistema hidráulico ofrece un recorrido mayor que los tensores mecánicos, es particularmente recomendable para motores V6/V8. Sus características los hacen muy apropiado para controlar el comportamiento dinámico de la banda.

#### ¿Por qué reemplazarlo?

Desgaste normal del cojinete en la polea del tensor.

Escape de aceite por contaminación en las juntas.

**GATES: LA MARCA DE MÁS PRESTIGIO EN BANDAS, MANGUERAS, HIDRÁULICA Y NEUMÁTICA.**

## Productos Gates \* Características y especificaciones

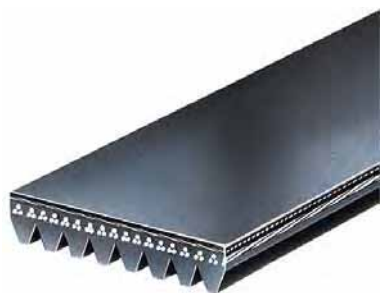

### Bandas Micro-V® AT (Serpentín)

Bandas para serpentín, diseñadas para todas las marcas de automóviles en el mundo. Su diseño especial hace que la banda dure más del doble que su cercano competidor, en aplicaciones problemáticas.

- Silenciosas por su perfil desbastado y alta flexibilidad.
- Mínimo estiramiento por lo que no es necesario re-tensionar.
- Cuerda (refuerzo) de gran resistencia y durabilidad.
- Construido especialmente para resistir desgaste y agrietarse.
- Su diseño especial asegura un control dimensional exacto.
- Exceden las especificaciones de la norma SAE J1459.  
(Tipo de Producto 8552 y 8160).



### Bandas Micro-V® de Doble lado

Para reemplazar las bandas de serpentín de equipo original que requieren un grado más alto de eficacia al transmitir potencia. Diseñadas para las poleas de diámetro pequeños y para el uso con (o sin) los tensores automáticos.

- Pequeñas ranuras en V en ambos lados de la banda.
- Altamente resistente al aceite, al calor y a otras condiciones adversas.
- Amplia cobertura de aplicaciones.
- Exceden los estándares de la Asociación del Fabricante de Hule (RMA por sus siglas en inglés) para la conductividad estática.
- Exceden las especificaciones de la norma SAE J1459.



### TR y XL® bandas en V

La banda más exigente en el Mercado de reemplazo. Su forma trapezoidal con ranuras le permite tener un mejor agarre a las poleas. Esto permite un mejor funcionamiento de la banda, reduciendo su elongación y ruido.

- La acción de su compuesto de hule y su refuerzo, dan mayor flexibilidad a lo largo de toda la banda, ofreciendo una mayor estabilidad en las poleas.
- Cuerdas tensoras con refuerzo de aramida.
- Exceden las especificaciones de la norma SAE J636c.  
(Tipo de producto 8701)



### Bandas Timing para árbol de levas

Diseñadas para altos rangos de velocidad constante y requerimientos de potencia para mover el árbol de levas. Cumple o excede los requerimientos de desempeño de los fabricantes de autos en todo el mundo. Aprobadas para aplicaciones marinas. Gates es el fabricante de estas bandas para las mejores marcas Audi, BMW, Chrysler, Fiat, Ford, GM, Honda, Hyundai, Isuzu, Mazda, Mitsubishi, Nissan, Peugeot, Renault, Subaru, Toyota, Volvo, Volkswagen.

- La más amplia cobertura de aplicaciones en el mercado de reemplazo.
- Resistencia, su cubierta patentada es altamente resistente al calor y al aceite.
- La alta resistencia de sus cuerdas tensoras, minimizan su elongación (estiramiento).  
(Tipo de producto 8595).

**GATES: LA MARCA DE MÁS PRESTIGIO EN BANDAS, MANGUERAS, HIDRÁULICA Y NEUMÁTICA.**

## Productos Gates \* Características y especificaciones

### Bandas para motonetas y cuatrimotos PowerLink®

Bandas de Velocidad variable, cargas de choque. Diseñadas especialmente para Motonetas, Vehículos Todo Terreno - Cuatrimotor (ATV siglas en inglés) y carros de Golf.

- Bandas de alta flexibilidad que permiten mayor agarre a la polea.
- Reforzado con las fibras de aramida para proporcionar un desempeño óptimo.

NOTA: Utilice las bandas especiales PowerLink® para este tipo de aplicación.  
(Tipo de producto 9817 & 9807).



### Bandas Hi-Power® II

Diseñadas para un alto desempeño, secciones disponibles A,B,C,D y E.

Estas han sido las bandas preferidas del mercado por su perfil único y su excelente fabricación.

- Cubierta Flex-Weave® de alta flexibilidad y excelente resistencia al calor, ozono y aceites.
  - Cuerdas Flex-Bonded de alta capacidad de transmisión de potencia y mínimo estiramiento.
  - Paredes curvas y lomo arqueado para una mejor distribución de la fuerza.
  - Su tipo de construcción Multi-propósitos aplica para varios tipos de vehículos.
  - Cumple con las pruebas de conductividad estática de la RMA (Rubber Manufacturer's Association).
  - V80 programa Gates que garantiza el "Hermanaje" de las bandas (de dimensiones iguales).
- (Tipo de producto 9112 Sec. A – 9113 Sec. B).



### Bandas Tri-Power®

Bandas dentadas para la transmisión de potencia en poleas en V, en maquinaria industrial y vehículos de servicio pesado. Combina las ventajas de las tradicionales bandas Hi-Power con las de las bandas dentadas.

(Tipo de producto 9012 Sec. AX – 9013 Sec. BX).



### Bandas Vulco®

Banda forrada recomendada para transmitir potencia y movimiento en poleas en V. Ideal para los motores de Volkswagen enfriados por aire, como el del Sedán por sus características especiales de tensado de la banda.

(Tipo de producto 8560).



### Bandas PowerBand®

Bandas unidas para transmitir potencia en poleas en V para aplicaciones de servicio pesado donde las bandas individuales se voltean por el alto torque en el momento del arranque o durante la aceleración.

(Tipo de producto 8541 Importadas PB, 9091 Nacional PK).



**GATES: LA MARCA DE MÁS PRESTIGIO EN BANDAS, MANGUERAS, HIDRÁULICA Y NEUMÁTICA.**



## Herramientas:



### Alineador Láser DriveAlign™

Exclusivo, herramienta patentada compatible con todas las marcas de automóviles para alineación de poleas.

DriveAlign® (No. De Parte 91006)

Identifica rápidamente los dos tipos de desalineación de las poleas más comunes – desalineación angular y horizontal, los cuales reducen la vida de servicio de los componentes y produce ruido en las transmisiones de las bandas. Simplemente con colocar el alineador en las ranuras de la polea y apuntar el láser a la polea opuesta. Cualquier desalineación será visible en un instante.

- Esta herramienta patentada es compatible con todas las transmisiones que utilicen bandas serpentín.
- Ligera y fácil de usar.
- Incluye lentes especiales que amplifican el láser para mejorar la visión en condiciones de baja iluminación.
- Incluye un estuche durable de alto impacto.

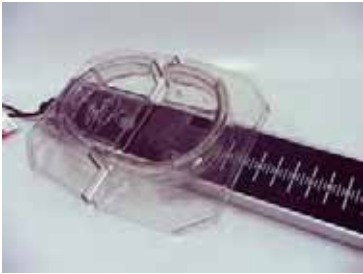

### Medidor Banda Micro-V®

Esta herramienta mide cada banda Micro-V para asistirle en determinar la banda de reemplazo para autos, camionetas, autobuses y camiones de servicio pesado... cuando la banda usada está disponible.

- Se puede medir bandas desde 36" hasta 120". (Cerrado mide solamente 3 pies.)
- Ligero, exacto, y fácil de usar. (No. De Parte 91202)

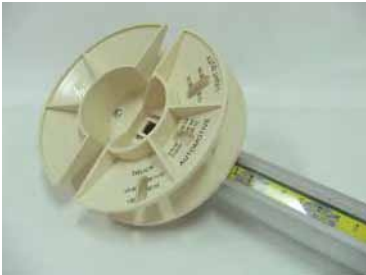

### Localizador Banda-V

Esta herramienta ayuda a identificar el tipo de banda en V que se requiere.

- Identifica el ancho superior de la banda
- Identifica el tipo y longitud de la banda.
- Ligero, exacto y fácil de usar. (No. De Parte 91201)



### Kit Completo para reemplazo de bandas Timing

(No. Part 91007)

Incluye un probador de tensión para bandas Timing.

(no. part 91000), Una herramienta para fijar los engranes del árbol de levas (no. part 91008) y dos Multi-Lock . (no. part 91009).

**GATES: LA MARCA DE MÁS PRESTIGIO EN BANDAS, MANGUERAS, HIDRÁULICA Y NEUMÁTICA.**

## Productos Gates \* Características y especificaciones

### Krikrit II Micro-V® - Medidor de tensión de bandas

(No. Part 91132.)

Diseñado para las bandas Micro-V® en los automóviles, camionetas, Tractocamiones y autobuses.

- Cojín para medir presión y brazo indicador color verde intenso.
- Calibrado para medir la tensión a partir de 100 a 320 libras. y 50 a 150 kilogramos.
- Para hacer mediciones de bandas hasta de 8 costillas de ancho.



### Krikrit V-Bandas Medidor de tensión

(Part No. 91107. Charge Item.)

Permite que el usuario tense las bandas durante la instalación, mientras que el motor se encuentre apagado. Esto es importante para un buen funcionamiento de las bandas. Útil para todos las Bandas automotrices en V, se incluyen bandas con anchos superiores a 7/8".

- Incluye instrucciones de uso.
- Lee escalas en libras y kilogramos, a partir de 30 a 160 libras y 15 a 75 kilogramos.
- Cuerpo de aluminio, brazo indicador de nylon y cojín para medir la presión.
- Tiene clip de bolsillo (acero inoxidable).

**NOTA:** No para el uso en bandas TIMING.



### Probador de tensión para bandas Timing

(No. Part 91000)

Proporciona un método exacto para probar la tensión para todas las bandas de sincronización automotriz (Timing).

- El probador de tensión Gates, es útil para cualquier banda Timing hasta 30 mm de ancho.
- Viene con los adaptadores para los diferentes groesos de las bandas.
- Método de aplicación para medir la tensión (desviación de fuerza).
- La escala se puede leer en cualquier posición. Incluye el cupón para el CD-ROM libre de la instalación de la banda dentada.



### Herramienta para tensar las bandas de Serpentin

(No. Part. 91015)

Herramienta ideal para quitar e instalar las bandas de serpiente. Proporciona la fuerza necesaria para desplazar el brazo de la polea tensora.

- El nuevo diseño de 3 barras incluye siete adaptadores (13m m, 14m m, 15m m, 16m m, 18m m, 3/8 " y el 1/2 ").



**GATES: LA MARCA DE MÁS PRESTIGIO EN BANDAS, MANGUERAS, HIDRÁULICA Y NEUMÁTICA.**

# Guía de Poleas DriveAlign®

Listado por número de parte

No. De Parte	Material	Diámetro Exterior	Diámetro del buje	Ancho	Tipo de banda	Superficie de la polea
36026	Acero	70mm	12mm	30mm	6 costillas K	V-Ranurada
T36038	Termoplástico	80mm	8mm	30.3mm	6 costillas K	V-Ranurada
36060	Termoplástico	80mm	24mm*	29mm	3/8 V – SAE 10A	V-Ranurada
36086	Acero	84mm	12mm	25mm	6 costillas K	Lisa
36087	Acero	78mm	12mm	20mm	5 Costillas K	Lisa
36091	Acero	74mm	17mm	39.25mm	10 Costillas K	Lisa
36092	Acero	74mm	17mm	46.25mm	12 Costillas K	Lisa
36093	Acero	72.5mm	17mm	38mm	8 Costillas K	V-Ranurada
36094	Termoplástico	78mm	17mm	32.8mm	8 Costillas K	Lisa
36095	Acero	74mm	17mm	32.8mm	8 Costillas K	Lisa
36096	Acero	86.5mm	17mm	39.4mm	10 Costillas K	Lisa
36097	Acero	119mm	17mm	38mm	8 Costillas K	V-Ranurada
36098	Termoplástico	72mm	17mm	39mm	10 Costillas K	V-Ranurada
36099	Acero	70mm	15mm	20.5mm	4 Costillas K	V-Ranurada
36100	Acero	76mm	17mm	29.5mm	6 Costillas K	V-Ranurada
36101	Acero	70mm	17mm	31mm	6 Costillas K	Lisa
36102	Termoplástico	90mm	17mm	32mm	7 Costillas K	V-Ranurada
36103	Acero	107mm	12mm	32mm	3/8 V – SAE 10A	V-Ranurada
38001	Acero	90mm	17mm	30mm	6 Costillas K	Lisa
38002	Acero	100mm	17mm	30.5mm	6 Costillas K	Lisa
38003	Acero	94.5mm	12mm	16.5mm	3/8 V – SAE 10A	V-Ranurada
38004	Acero	118mm	12mm	16.5mm	3/8 V – SAE 10A	V-Ranurada
38005	Acero	82mm	17mm	30.5mm	6 Costillas K	Lisa
38006	Acero	76mm	17mm	30.5mm	6 Costillas K	Lisa
38007	Termoplástico	90mm	17mm	25.5mm	6 Costillas K	Lisa
38008	Termoplástico	70mm	17mm	34.5mm	6 Costillas K	V-Ranurada
38009	Termoplástico	76mm	17mm	25mm	6 Costillas K	V-Ranurada
38010	Acero	90mm	17mm	27mm	5 Costillas K	Lisa
38011	Acero	82mm	17mm	27mm	5 Costillas K	Lisa
38012	Termoplástico	90mm	17mm	32mm	6 Costillas K	Lisa
38015	Termoplástico	76mm	17mm	25mm	6 Costillas K	Lisa
38016	Termoplástico	76mm	17mm	32mm	7 Costillas K	V-Ranurada
38017	Termoplástico	90mm	17mm	22mm	4 Costillas K	V-Ranurada
38018	Termoplástico	70mm	17mm	25mm	6 Costillas K	Lisa
38019	Termoplástico	90mm	17mm	26.3mm	6 Costillas K	V-Ranurada
38020	Acero	90mm	12mm	30.5mm	6 Costillas K	Lisa
38022	Acero	90mm	17mm	37.5mm	8 Costillas K	Lisa
38023	Termoplástico	76mm	17mm	34mm	8 Costillas K	Lisa
38024	Termoplástico	09mm	17mm	26.3mm	6 Costillas K	V-Ranurada
38025	Termoplástico	52mm	17mm	15mm	3 Costillas K	V-Ranurada
38026	Acero	100mm	17mm	28mm	5 Costillas K	Lisa
38027	Termoplástico	82mm	17mm	25mm	6 Costillas K	Lisa
38028	Acero	76mm	17mm	37mm	8 Costillas K	Lisa
38029	Termoplástico	7mm	17mm	26mm	6 Costillas K	V-Ranurada
38030	Acero	70mm	17mm	20.5mm	4 Costillas K	V-Ranurada
38031	Acero	70mm	12mm	20.5mm	4 Costillas K	V-Ranurada
38032	Termoplástico	76mm	17mm	22mm	5 Costillas K	Lisa
38033	Acero	90mm	17mm	33mm	7 Costillas K	Lisa
38034	Termoplástico	27mm	12mm	29mm	6 Costillas K	V-Ranurada
38035**	Acero	94mm		19mm	1/2 V – SAE 13A	V-Ranurada

**GATES: LA MARCA DE MÁS PRESTIGIO EN BANDAS, MANGUERAS, HIDRÁULICA Y NEUMÁTICA.**

# Guía de Poleas DriveAlign®

Listado por número de parte

No. De Parte	Material	Diámetro Exterior	Diámetro del buje	Ancho	Tipo de banda	Superficie de la polea
38036	Acero	81mm	12mm	17.5mm	1/2 V – SAE 13A	V-Ranurada
38037	Acero	81mm	17mm	18mm	1/2 V – SAE 13A	V-Ranurada
38038	Acero	94mm	17mm	19mm	1/2 V – SAE 13A	V-Ranurada
38039**	Acero	94mm		19mm	1/2 V – SAE 13A	V-Ranurada
38040	Acero	123mm	12mm	18.5mm	1/2 V – SAE 13A	V-Ranurada
38041	Acero	76mm	17mm	30.5mm	6 Costillas K	Lisa
38042	Acero	90mm	10mm	30mm	6 Costillas K	Lisa
38043	Acero	76mm	10mm	30mm	6 Costillas K	Lisa
38044	Acero	80mm	17mm	21.8mm	4 Costillas K	V-Ranurada
38045	Termoplástico	70mm	24mm*	28mm	6 Costillas K	Lisa
38046	Termoplástico	80mm	24mm*	27mm	6 Costillas K	Lisa
38047	Termoplástico	70mm	14.5mm*	31.5mm	6 Costillas K	Lisa
38048	Termoplástico	80mm	14.5mm*	31.5mm	6 Costillas K	Lisa
38049**	Acero	80mm		31mm	6 Costillas K	Lisa
38050**	Acero	76mm		31mm	6 Costillas K	Lisa
38051**	Acero	76mm		25mm	6 Costillas K	Lisa
38052	Acero	90mm	17mm	37mm	8 Costillas K	V-Ranurada
38053	Acero	76mm	17mm	38mm	8 Costillas K	V-Ranurada
38058	Termoplástico	76mm	17mm	29.5mm	7 Costillas K	Lisa
38061**	Termoplástico	75mm	24.5mm*	24.5mm	7 Costillas K	Lisa
38062**	Termoplástico	70mm	24mm*	28mm	7 Costillas K	Lisa
38063**	Termoplástico	70mm	17mm	28mm	7 Costillas K	Lisa
38064**	Termoplástico	70mm	24mm*	28mm	7 Costillas K	Lisa
38065**	Termoplástico	70mm	24mm*	28mm	7 Costillas K	Lisa
38066**	Termoplástico	70mm	24mm*	28mm	7 Costillas K	Lisa
38068**	Acero	60mm	25.7mm*	22.5mm	4 Costillas K	V-Ranurada
38069	Termoplástico	80mm	10.2mm	37mm	6 Costillas K	Lisa
38070	Termoplástico	80mm	8mm	21mm	4 Costillas K	Lisa
38071	Termoplástico	70mm	24.5mm*	24.5mm	6 Costillas K	Lisa
38073	Termoplástico	70mm	24mm*	28mm	7 Costillas K	Lisa
38074	Termoplástico	80mm	12.2mm	25mm	6 Costillas K	Lisa
38075	Acero	75mm	30mm	32.5mm	8 Costillas K	Lisa
38076	Acero	75mm	30mm	40mm	10 Costillas K	Lisa
38077	Termoplástico	80mm	17mm	25mm	5 Costillas K	Lisa
38078	Termoplástico	90mm	24.5mm*	27.5mm	6 Costillas K	Lisa
38079	Termoplástico	90mm	24mm*	27.8mm	6 Costillas K	Lisa
38080	Termoplástico	75mm	24mm*	28.5mm	6 Costillas K	V-Ranurada
38081	Termoplástico	80mm	24mm*	31mm	6 Costillas K	Lisa
38082	Termoplástico	63.5mm	17 mm	26.5mm	6 Costillas K	V-Ranurada
38083	Termoplástico	64mm	8.2mm	23mm	6 Costillas K	V-Ranurada
38084	Termoplástico	80mm	14.5mm*	40mm	8 Costillas K	Lisa
38087	Termoplástico	78mm	9mm	25mm	6 Costillas K	Lisa
38088	Acero	70mm	15mm	18mm	3/8 V – SAE 10A	V-Ranurada
38090	Termoplástico	63.5mm	14.5mm*	31mm	6 Costillas K	V-Ranurada
38091	Termoplástico	64mm	14.5mm*	35.5mm	8 Costillas K	V-Ranurada
38092	Termoplástico	70mm	14.5mm*	31mm	6 Costillas K	V-Ranurada
38093	Termoplástico	85mm	14.5mm*	30mm	6 Costillas K	Lisa

\* Doble borde \*\* Esta parte es un montaje del soporte con la polea y por lo tanto faltan algunos datos de medición.

**GATES: LA MARCA DE MÁS PRESTIGIO EN BANDAS, MANGUERAS, HIDRÁULICA Y NEUMÁTICA.**

# Guía de Poleas Decopladoras DriveAlign®

Listado por número de parte

No. De Parte	Material	Diámetro Exterior	Diámetro del buje	Ancho	Tipo de banda	Superficie de la polea
37010P	Acero	50mm	14.5mm	40.5mm	6 Costillas K	V-Ranurada
37011P	Acero	55.5mm	14.5mm	37.5mm	6 Costillas K	V-Ranurada
37012P	Acero	55.5mm	14.5mm	42.5mm	6 Costillas K	V-Ranurada
37013P	Acero	52.5mm	14.5mm	35.5mm	6 Costillas K	V-Ranurada
37014P	Acero	56mm	14.5mm	42.5mm	6 Costillas K	V-Ranurada

## Tipo de Poleas DriveAlign®



**Poleas Metálicas y Termoplásticas**

- Dispositivo guía para la banda que actúa con ella al mismo tiempo para transmitir potencia al sistema de accesorios del automóvil.



**Poleas Locas**

- Son aquellas que poseen movimiento libre, es decir, no pertenecen a un componente como bomba de agua, compresor de AA o alternador.



**Poleas Decopladoras**

- Son aquellas que mueven el alternador en conjunto con la banda, sin embargo, la polea tiene un balero especial que le permite rotar libremente en una sola dirección.

- Las poleas Gates se construyen en acero o Nylon, capaces de soportar cargas de choque, altas velocidades (8,000 RPM), carga a la tensión (65,000 lb/pul<sup>2</sup>), además de ser silenciosas.
- Son las mejores en el mercado de reemplazo, ya que utilizan lubricantes y sellos que soportan mucho mayor grados de temperaturas, previniendo así el desgaste y fallas.

**GATES: LA MARCA DE MÁS PRESTIGIO EN BANDAS, MANGUERAS, HIDRÁULICA Y NEUMÁTICA.**

## Productos Gates \* FORMAS Y DIMENSIONES

# POLEA DECOPLADORA



Siempre que el motor se desacelera, por ejemplo, durante un cambio de marcha o apagado del motor, la inercia del alternador crea una resistencia en la banda. La polea decopladora permite que el alternador “se mueva libremente” o se “sobre acelere” cuando la banda, de repente aminora la velocidad. Esto evita que la banda se deslice y reduce la vibración, el desgaste y los rechinidos.

**La polea decopladora DriveAlign® de Gates aumenta el rendimiento y la durabilidad de todos los componentes del sistema de transmisión por bandas para accesorios.**

### Componentes de una polea decopladora DriveAlign®



Gates recomienda: ¡Si una de estas dos pruebas falla, se debe sustituir inmediatamente la polea decopladora!

**o 1ª prueba:** Utilice el dedo índice y el pulgar para sujetar el anillo interior (eje) en su sitio. Gire el anillo exterior con la otra mano en la misma dirección que lo haría la banda. Si el anillo exterior se mueve, tiene que sustituir la polea decopladora.

**o 2ª prueba:** Sujete el anillo interno (eje) para que no se mueva. Gire el anillo exterior en la dirección contraria a la banda.

**GATES: LA MARCA DE MÁS PRESTIGIO EN BANDAS, MANGUERAS, HIDRÁULICA Y NEUMÁTICA.**

Productos Gates \* FORMAS Y DIMENSIONES

# Guía de Tensores DriveAlign® y PowerGrip®

Listado por número de parte

No. Parte	Dimensiones
36026	Acero Polea Ranurada 6 costillas (70mm x 12mm x 26mm)
36079	Para Banda de 6 Costillas - Termoplástico (60mm x 20mm x 25mm)
36091	Acero Poleas/Lisa (74mm x 17mm x 39.25mm)
36092	Acero Poleas/Lisa (74mm x 17mm x 46.25mm)
36093	Acero Ranurada 8 Costillas (74mm x 17mm x 37mm)
36095	Acero Poleas/Lisa (74mm x 17mm x 33mm)
36096	Acero Poleas/Lisa (86.5mm x 17mm x 39.4mm)
36098	Termoplástico Ranurada 10 Costillas (74mm x 17mm x 39mm)
36112	Acero Poleas/Lisa (76.3mm x 17mm x 29.5mm)
36115	Acero Poleas/Lisa (83.5mm x 12mm x 18mm)
36116	Acero Polea/Ranurada (100mm x 17mm x 18.8mm)
36118	Acero Polea/Ranurada (80mm x 17mm x 25mm)
36119	Acero Poleas/Lisa (102mm x 17mm x 26mm)
36136	Acero Polea Ranurada 6 costillas (72mm x 15mm x 26mm)
36137	Acero Polea Lisa (70mm x 15mm x 25mm)
36142	Acero Poleas/Lisa (83.5mm x 17mm x 30mm) - W/12mm Bushing
36152	Acero Poleas/Lisa (70mm x 17mm x 20.5mm)
36156	Termoplástico Poleas/Lisa (70mm x 17mm x 19mm)
36157	Acero Polea Ranurada 6 costillas (87mm x 17mm x 31mm) - Flanged
36157	Acero Polea Ranurada 6 costillas (87mm x 17mm x 31mm) - Flanged
36169	Acero Poleas/Lisa (60mm x 12mm x 21.25mm)
38001	Acero Poleas/Lisa (90mm x 17mm x 30.5mm)
38006	Acero Poleas/Lisa (76mm x 17mm x 30.5mm)
38008	Para Banda de 6 Costillas - Termoplástico (70mm x 17mm x 25mm)
38009	Para Banda de 6 Costillas - Termoplástico (76mm x 17mm x 25mm)
38015	Termoplástico Poleas/Lisa (76mm x 17mm x 25mm)
38022	Acero Poleas/Lisa (90mm x 17mm x 37.5mm)
38023	Termoplástico Poleas/Lisa (76mm x 17mm x 34mm)
38028	Acero Poleas/Lisa (76mm x 17mm x 37mm)
38033	Acero Poleas/Lisa (90mm x 17mm x 33mm)
38049	Acero Poleas/Lisa (80mm x N/A x 31mm)
38053	Acero Ranurada 8 Costillas (76mm x 17mm x 38mm)
38061	Termoplástico Poleas/Lisa (75mm x 24.5mm x 8.2mm x 24.5mm) - C/Perno
38062	Termoplástico Poleas/Lisa (70mm x 27mm x 8.2mm x 28mm)

**GATES: LA MARCA DE MÁS PRESTIGIO EN BANDAS, MANGUERAS, HIDRÁULICA Y NEUMÁTICA.**

## Productos Gates \* FORMAS Y DIMENSIONES

No. Parte	Dimensiones
38063	Termoplástico Poleas/Lisa (70mm x 17mm x 28mm) - C/Perno
38066	Termoplástico Poleas/Lisa (70mm x 24mm x 8.2mm x 28mm) - C/Perno
38068	Para Banda de 4 Costillas - Acero (60mm x 25.7mm x 10.2mm x 22.5mm)
38075	Acero Poleas/Lisa (75mm x 30mm x 32.5mm)
38076	Acero Poleas/Lisa (75mm x 30mm x 32.5mm)
38092	Para Banda de 6 Costillas - Termoplástico (70mm x 14.5mm x 8mm x 26.5mm)
38099	ND
38101	Para Banda de 6 Costillas - Acero (100mm x 17mm x 30.5mm)
38102	Para Banda de 6 Costillas - Termoplástico (70mm x 17mm x 25mm)
38103	Para Banda de 6 Costillas - Termoplástico (70mm x 17mm x 25mm)
38104	Para Banda de 6 Costillas - Termoplástico (76mm x 17mm x 25mm)
38105	Para Banda de 6 Costillas - Termoplástico (90mm x 17mm x 25.5mm)
38106	Para Banda de 6 Costillas - Termoplástico (76mm x 17mm x 25mm)
38107	Para Banda de 6 Costillas - Acero (90mm x 17mm x 30.5mm)
38108	Para Banda de 6 Costillas - Acero (90mm x 17mm x 30.5mm)
38109	Para Banda de 5 Costillas - Acero (100mm x 17mm x 28mm)
38110	Para Banda de 5 Costillas - Acero (100mm x 17mm x 28mm)
38111	Para Banda de 6 Costillas - Acero (100mm x 17mm x 30.5mm)
38112	Para Banda de 5 Costillas - Acero (90mm x 17mm x 30mm)
38113	Para Banda de 6 Costillas - Acero (90mm x 17mm x 30.5mm)
38114	Para Banda de 6 Costillas - Acero (76mm x 17mm x 30.5mm)
38115	Para Banda de 6 Costillas - Termoplástico (90mm x 17mm x 25.5mm)
38116	Para Banda de 7 Costillas - Termoplástico (76mm x 17mm x 32mm)
38117	Para Banda de 6 Costillas - Acero (76mm x 17mm x 30.5mm)
38118	Para Banda de 6 Costillas - Acero (76mm x 17mm x 30.5mm)
38119	Para Banda de 8 Costillas - Acero (90mm x 17mm x 37.5mm)
38120	Para Banda de 6 Costillas - Acero (82mm x 17mm x 30.5mm)
38121	Para Banda de 6 Costillas - Acero (76mm x 17mm x 30.5mm)
38122	Para Banda de 6 Costillas - Acero (90mm x 17mm x 30.5mm)
38123	Para Banda de 6 Costillas - Acero (76mm x 17mm x 30.5mm)
38124	Para Banda de 6 Costillas - Acero (90mm x 17mm x 30.5mm)
38125	Para Banda de 6 Costillas - Acero (82mm x 17mm x 30.5mm)
38126	Para Banda de 6 Costillas - Acero (82mm x 17mm x 30.5mm)
38127	Para Banda de 6 Costillas - Termoplástico (76mm x 17mm x 25mm)
38128	Para Banda de 6 Costillas - Termoplástico (82mm x 17mm x 25mm)
38129	Para Banda de 6 Costillas - Acero (90mm x 17mm x 30.5mm)
38130	Para Banda de 6 Costillas - Acero (90mm x 17mm x 30.5mm)

**GATES: LA MARCA DE MÁS PRESTIGIO EN BANDAS, MANGUERAS,  
HIDRÁULICA Y NEUMÁTICA.**



Productos Gates \* FORMAS Y DIMENSIONES

# Guía de Tensores DriveAlign® y PowerGrip®

Listado por número de parte

No. Parte	Dimensiones
38131	Para Banda de 6 Costillas - Acero (90mm x 17mm x 37.5mm)
38132	Para Banda de 6 Costillas - Acero (76mm x 17mm x 30.5mm)
38133	Para Banda de 8 Costillas - Termoplástico (76mm x 17mm x 34mm)
38134	Para Banda de 6 Costillas - Acero (100mm x 17mm x 30.5mm)
38135	Para Banda de 4 Costillas - Termoplástico (90mm x 17mm x 22mm)
38136	Para Banda de 6 Costillas - Acero Poleas/Lisa (76mm x 17mm x 30.5mm)
38137	Para Banda de 6 Costillas - Termoplástico (70mm x 17mm x 25mm)
38138	Para Banda de 6 Costillas - Termoplástico (90mm x 17mm x 25.5mm)
38139	Para Banda de 6 Costillas - Termoplástico (76mm x 17mm x 25mm)
38140	Para Banda de 6 Costillas - Termoplástico (90mm x 17mm x 32mm) - C/Bridas
38141	Para Banda de 6 Costillas - Termoplástico (90mm x 17mm x 26.3mm)
38142	Para Banda de 6 Costillas - Acero (90mm x 17mm x 30.5mm)
38143	Para Banda de 6 Costillas - Acero (90mm x 17mm x 37.5mm)
38144	Para Banda de 6 Costillas - Termoplástico (90mm x 17mm x 25.5mm)
38145	Para Banda de 6 Costillas - Acero (90mm x 17mm x 30.5mm)
38146	Para Banda de 5 Costillas - Acero (82mm x 17mm x 27mm)
38147	Sin Polea
38148	Para Banda de 6 Costillas - Termoplástico (70mm x 17mm x 25mm)
38150	Para Banda de 6 Costillas - Termoplástico (70mm x 17mm x 25mm)
38151	Para Banda de 5 Costillas - Acero (76mm x 17mm x 24mm)
38152	Para Banda de 6 Costillas - Termoplástico (76mm x 17mm x 25mm)
38153	Para Banda de 6 Costillas - Acero Poleas/Lisa (76mm x 17mm x 30.5mm)
38155	Para Banda de 6 Costillas - Acero Poleas/Lisa (76mm x 17mm x 31mm) – C/Perno
38156	Para Banda de 5 Costillas - Acero (90mm x 17mm x 30mm)
38157	Para Banda de 6 Costillas - Acero Poleas/Lisa (76.2mm x 10.3mm x 33mm)
38158	Para Banda de 6 Costillas - Termoplástico (76mm x 17mm x 25mm)
38159	Para Banda de 4 Costillas - Acero (60mm x 12mm x 21mm)
38160	Para Banda de 6 Costillas - Acero Ranurada (98mm x 17mm x 27mm)
38161	Acero Poleas/Lisa (100mm x 17mm x 30.5mm)
38162	Para Banda de 6 Costillas - Acero (76mm x 17mm x 30.5mm)
38163	Para Banda de 6 Costillas - Termoplástico (70mm x 17mm x 25mm)
38164	Para Banda de 6 Costillas - Termoplástico (76mm x 17mm x 25mm)
38165	Para Banda de 6 Costillas - Termoplástico (76mm x 17mm x 25mm)
38167	Para Banda de 6 Costillas - Acero (90mm x 17mm x 29.5mm); Termoplástico (76mm x 17mm x 28mm)

**GATES: LA MARCA DE MÁS PRESTIGIO EN BANDAS, MANGUERAS, HIDRÁULICA Y NEUMÁTICA.**

## Productos Gates \* FORMAS Y DIMENSIONES

No. Parte	Dimensiones
38168	Para Banda de 6 Costillas - Termoplástico (76mm x 17mm x 22mm)
38169	Para Banda de 6 Costillas - Acero (90mm x 17mm x 30.5mm)
38171	Para Banda de 6 Costillas - Acero (90mm x 17mm x 30.5mm)
38172	Para Banda de 6 Costillas - Acero (70mm x 17mm x 24mm)
38173	Acero Poleas/Lisa (102mm x 17mm x 26mm)
38174	Para Banda de 6 Costillas - Termoplástico (90mm x 17mm x 26mm)
38175	Para Banda de 7 Costillas - Termoplástico (62mm x 17mm x 29mm)
38176	Termoplástico Poleas/Lisa (70mm x 17mm x 19mm)
38177	Para Banda de 5 Costillas - Acero (82mm x 17mm x 27mm)
38178	Para Banda de 6 Costillas - Termoplástico (70mm x 17mm x 25mm)
38179	Para Banda de 6 Costillas - Termoplástico (76mm x 17mm x 25mm)
38180	Acero Poleas/Lisa (76mm x 17mm x 31mm)
38181	Acero Poleas/Lisa (76mm x 17mm x 30.5mm)
38182	Acero Poleas/Lisa (76mm x 17mm x 30.5mm)
38185	Acero Poleas/Lisa (70mm x 17mm x 25mm)
38186	Termoplástico Ranurada 6 Costillas (70mm x 17mm x 25mm)
38187	Acero Poleas/Lisa (90mm x 17mm x 30.5mm)
38188	Termoplástico Ranurada 6 Costillas (70mm x 17mm x 25mm)
38189	Acero Poleas/Lisa (76mm x 17mm x 30.5mm)
38190	Termoplástico Poleas/Lisa (70mm x 17mm x 25mm)
38191	Acero Poleas/Lisa (76mm x 17mm x 37mm); Acero Ranurada 8 Costillas (76mm x 17mm x 38mm)
38191	Acero Poleas/Lisa (76mm x 17mm x 37mm); Acero Ranurada 8 Costillas (76mm x 17mm x 38mm)
38192	Acero Poleas/Lisa (70mm x 17mm x 24mm) - C/ Actuador Hidráulico
38193	Para Banda de 6 Costillas - Acero (76mm x 17mm x 25mm)
38194	Para Banda de 6 Costillas - Termoplástico (70mm x 17mm x 25mm)
38195	Termoplástico Ranurada 6 Costillas (70mm x 17mm x 25mm)
38196	Para Banda de 4 Costillas - Termoplástico (65mm x 17mm x 20mm)
38197	Termoplástico Ranurada 3 Costillas (52mm x 17mm x 15mm)
38198	Termoplástico Poleas/Lisa (82mm x 17mm x 25mm)
38200	Para Banda de 6 Costillas - Termoplástico (70mm x 17mm x 25mm)
38201	Termoplástico Poleas/Lisa (70mm x 17mm x 26mm)
38207	Acero Poleas/Lisa (76mm x 17mm x 28mm)
38216	Acero Poleas/Lisa (70mm x 17mm x 32mm) - C/ Actuador Hidráulico
38218	Sin Polea
38219	Sin Polea
38220	Sin Polea
38221	Sin Polea

**GATES: LA MARCA DE MÁS PRESTIGIO EN BANDAS, MANGUERAS,  
HIDRÁULICA Y NEUMÁTICA.**

## Productos Gates \* FORMAS Y DIMENSIONES

No. Parte	Dimensiones
38223	Termoplástico Poleas/Lisa (70mm x 17mm x 26.4mm)
38224	Termoplástico Poleas/Lisa (70mm x 17mm x 26mm)
38225	Sin Polea
38226	Termoplástico Poleas/Lisa (90.2mm x 17mm x 22.8mm)
38245	Termoplástico Ranurada 7 Costillas (90mm x 17mm x 32mm)
38246	Acero Poleas/Lisa (90mm x 17mm x 30.5mm)
38247	Termoplástico Poleas/Lisa (76mm x 17mm x 22mm)
38249	Termoplástico Poleas/Lisa (76mm x 17mm x 26mm)
38250	Acero Poleas/Lisa (76mm x 17mm x 30.5mm)
38251	Acero Poleas/Lisa (76mm x 17mm x 30.5mm)
38256	Acero Poleas/Lisa (90mm x 17mm x 33mm)
38257	Acero Poleas/Lisa (76mm x 17mm x 37mm); Acero Ranurada 8 Costillas (76mm x 17mm x 38mm)
38258	Acero Poleas/Lisa (76mm x 17mm x 30.5mm)
38258	Acero Poleas/Lisa (76mm x 17mm x 30.5mm)
38259	Acero Poleas/Lisa (63mm x 17mm x 18mm)
38260	Termoplástico Ranurada 6 Costillas (76mm x 17mm x 25mm)
38261	Acero Poleas/Lisa (76mm x 17mm x 23mm)
38266	Acero Poleas/Lisa (82mm x 17mm x 31mm)
38268	Termoplástico Poleas/Lisa (76mm x 17mm x 26mm)
38269	Termoplástico Poleas/Lisa (76mm x 17mm x 26mm)
38270	Termoplástico Poleas/Lisa (82mm x 17mm x 30mm)
38271	Acero Poleas/Lisa (76mm x 17mm x 31mm)
38273	Acero Poleas/Lisa (70mm x 17mm x 27mm)
38274	Acero Poleas/Lisa (76mm x 17mm x 30.5mm)
38275	Acero Poleas/Lisa (76mm x 17mm x 30.5mm)
38276	Termoplástico Ranurada 3 Costillas (52mm x 8mm x 13mm)
38277	ND
38278	Acero Poleas/Lisa (76.5mm x 17mm x 37.5mm)
38279	Acero Poleas/Lisa (76mm x 17mm x 30.5mm)
38284	Acero Poleas/Lisa (82.5mm x 17mm x 31mm)
38285	Acero Poleas/Lisa (76mm x 39mm)
38286	Termoplástico Poleas/Lisa (70mm x 17mm x 25mm)
38288	Acero Poleas/Lisa (76mm x 17mm x 30.5mm); Acero Poleas/Lisa (76mm x 17mm x 30.5mm)
38289	Termoplástico Poleas/Lisa (76mm x 17mm x 26mm)
38291	Acero Polea Ranurada 6 costillas (76mm x 17mm x 30mm)
38297	Termoplástico Poleas/Lisa (70mm x 17mm x 34mm)
38298	Acero Poleas/Lisa (76mm x 17mm x 37mm)

**GATES: LA MARCA DE MÁS PRESTIGIO EN BANDAS, MANGUERAS,  
HIDRÁULICA Y NEUMÁTICA.**

# Guía de Tensores DriveAlign® y PowerGrip®

Listado por número de parte

38299	Acero Poleas/Lisa (76.2mm x 17mm x 37mm)
38308	Acero Poleas/Lisa (70mm x 17mm x 25mm)
38317	Termoplástico Ranurada 7 Costillas (70mm x 17mm x 29mm)
38322	Acero Poleas/Lisa (85mm x 17mm x 31mm) – C/ Actuador Hidráulico
38323	Termoplástico Poleas/Lisa (70mm x 17mm x 26mm)
38324	Acero Poleas/Lisa (76mm x 17mm x 31.5mm)
38327	Acero Poleas/Lisa (90mm x 17mm x 29mm)
38328	Para Banda de 6 Costillas - Termoplástico (70mm x 17mm x 30mm)
38329	Acero Ranurada 6 Costillas (76mm x 17mm x 30mm) - C/Bridas
38330	Acero Ranurada 8 Costillas (76mm x 17mm x 38mm)
38332	Acero Poleas/Lisa (76.3mm x 17mm x 29.5mm)
38340	Acero Poleas/Lisa (102.5mm x 17mm x 34.5mm)
38341	Acero Poleas/Lisa (76mm x 17mm x 30.5mm)
38350	Termoplástico Ranurada 7 Costillas (76mm x 17mm x 32mm) - Flanged
38351	Acero Poleas/Lisa (76mm x 17mm x 31mm); Termoplástico Ranurada 6 Costillas (76mm x 17mm x 26mm)
38357	Acero Polea Ranurada 6 costillas (70mm x 17mm x 28mm) - Flanged
38358	Acero Poleas/Lisa (70mm x 17mm x 25mm)
38376	Termoplástico Poleas/Lisa (76mm x 17mm x 26mm)
38378	Acero Poleas/Lisa (76mm x 17mm x 36.3mm)
38382	Termoplástico Ranurada 7 Costillas (80mm x 17mm x 32mm)
38383	Termoplástico Ranurada 6 Costillas (76mm x 17mm x 25mm) - C/Bridas
38384	Termoplástico Poleas/Lisa (70mm x 17mm x 25mm)
38397	Acero Poleas/Lisa (70mm x 17mm x 31mm)
38408	Para Banda de 6 Costillas - Termoplástico (70mm x 17mm x 25mm) - Flanged, W/2 Bolts
38409	Para Banda de 6 Costillas - Termoplástico (70mm x 17mm x 25mm) - Flanged, W/2 Bolts
38411	Acero Poleas/Lisa (70mm x 17mm x 33.3mm)
38417	Termoplástico Poleas/Lisa (70mm x 17mm x 24mm)
38418	Acero Poleas/Lisa (70mm x 17mm x 31mm)
38419	Acero Poleas/Lisa (70mm x 17mm x 31mm)
38420	Para Banda de 6 Costillas - Termoplástico (74mm x 17mm x 26mm) - Flanged
38462	Acero Poleas/Lisa (65mm x 17mm x 23mm)
38501	Para Banda de 8 Costillas - Acero (75mm x 30mm x 32.5mm)
38502	Para Banda de 8 Costillas - Acero (75mm x 30mm x 32.5mm)

**GATES: LA MARCA DE MÁS PRESTIGIO EN BANDAS, MANGUERAS, HIDRÁULICA Y NEUMÁTICA.**

## Productos Gates \* FORMAS Y DIMENSIONES

No. Parte	Dimensiones
38503	Para Banda de 10 Costillas - Acero (75mm x 30mm x 40mm)
38504	Para Banda de 10 Costillas - Acero (75mm x 30mm x 40mm)
38505	Para Banda de 6 Costillas - Termoplástico (70mm x 17mm x 25mm)
38506	Para Banda de 10 Costillas - Acero (75mm x 30mm x 40mm)
38507	Acero Poleas/Lisa (75mm x 30mm x 40mm)
38508	Para Banda de 10 Costillas - Acero (75mm x 30mm x 40mm)
38509	Para Banda de 8 Costillas - Acero (75mm x 30mm x 32.5mm)
38510	Acero Poleas/Lisa (75mm x 30mm x 46.5mm)
38511	Para Banda de 10 Costillas - Acero (75mm x 30mm x 40mm)
38512	Para Banda de 10 Costillas - Acero (75mm x 30mm x 40mm)
38513	Para Banda de 10 Costillas - Acero (75mm x 30mm x 40mm)
38514	Para Banda de 10 Costillas - Acero (75mm x 30mm x 40mm)
38516	Acero Ranurada 8 Costillas (76.8mm x 30mm x 33.3mm)
38517	Acero Poleas/Lisa (75mm x 30mm x 32.5mm)
38519	Acero Poleas/Lisa (75mm x 30mm x 46mm)
38521	Acero Poleas/Lisa (75mm x 30mm x 43mm)
38523	Acero Poleas/Lisa (75mm x 30mm x 40mm)
38524	Acero Poleas/Lisa (75mm x 30mm x 40mm)
38525	Acero Ranurada 8 Costillas (76.8mm x 30mm x 33.3mm)
38527	Acero Ranurada 8 Costillas (76.8mm x 30mm x 33.3mm)
38529	Acero Poleas/Lisa (75mm x 30mm x 46.4mm)
38530	Acero Ranurada 12 Costillas (75mm x 30mm x 47.54mm)
38531	Acero Poleas/Lisa (70mm x 30mm x 37.1mm)
38532	Acero Poleas/Lisa (75mm x 30mm x 32.5mm)
38534	Acero Poleas/Lisa (74mm x 30mm x 46.4mm)
38535	Acero Poleas/Lisa (75mm x 30mm x 46.4mm)
38536	Acero Polea Ranurada 10 costillas (74mm x 30mm x 43mm)
38537	Acero Poleas/Lisa (75mm x 30mm x 46.5mm)
38539	Acero Poleas/Lisa (75mm x 30mm x 46.5mm)
38540	Acero Poleas/Lisa (75mm x 30mm x 40mm) - W/Bolt
38541	Acero Poleas/Lisa (75mm x 30mm x 40mm) - W/Bolt
38545	Para Banda de 6 Costillas - Termoplástico (76mm x 17mm x 25mm)
38547	Acero Poleas/Lisa (75mm x 30mm x 37mm) - W/Bolt
38548	Acero Poleas/Lisa (75mm x 30mm x 32.5mm)
38550	Acero Poleas/Lisa (75mm x 30mm x 40mm)
38556	Acero Poleas/Lisa (86.5mm x 30mm x 40mm)
38557	Acero Poleas/Lisa (75mm x 30mm x 40mm)

**GATES: LA MARCA DE MÁS PRESTIGIO EN BANDAS, MANGUERAS,  
HIDRÁULICA Y NEUMÁTICA.**

## Productos Gates \* FORMAS Y DIMENSIONES

No. Parte	Dimensiones
38567	Acero Poleas/Lisa (75mm x 30mm x 32.5mm)
38568	Acero Poleas/Lisa (75mm x 30mm x 32.5mm)
38569	Acero Poleas/Lisa (75mm x 30mm x 32.5mm)
38578	Acero Poleas/Lisa (75mm x 30mm x 40mm)
38579	Acero Poleas/Lisa (86.5mm x 30mm x 40mm)
38581	Acero Polea Ranurada 10 costillas (78mm x 30mm x 38mm) - W/Bolt
38584	Acero Poleas/Lisa (86.5mm x 30mm x 32mm) - W/Bolt
38585	Acero Poleas/Lisa (75mm x 30mm x 40mm)
38586	Acero Poleas/Lisa (75mm x 30mm x 40mm)
38587	Acero Poleas/Lisa (76.3mm x 17mm x 57mm)
38589	Termoplástico Ranurada 6 Costillas (76mm x 17mm x 25mm)
38590	Acero Poleas/Lisa (76mm x 17mm x 46mm)
38597	Acero Poleas/Lisa (75mm x 30mm x 32.5mm)
38598	Acero Poleas/Lisa (75mm x 30mm x 32.5mm)
38599	Termoplástico Ranurada 6 Costillas (76mm x 17mm x 25mm)
38607	Acero Poleas/Lisa (75mm x 30mm x 40mm)
38611	Acero Poleas/Lisa (75mm x 30mm x 46.4mm)
38617	Acero Polea Ranurada 6 costillas (80mm x 30mm x 30mm) - Flanged
38620	Acero Poleas/Lisa (75mm x 30mm x 40mm)
38622	Acero Poleas/Lisa (74mm x 30mm x 43mm)
37008P	Alternator Decoupler Pulleys
37010P	Acero Polea Ranurada 6 costillas (50mm x 14.5mm x 40.5mm)
37012P	Acero Polea Ranurada 6 costillas (55.5mm x 14.5mm x 42.5mm)
37013P	Acero Polea Ranurada 6 costillas (52.5mm x 14.5mm x 35.5mm)
37014P	Acero Polea Ranurada 6 costillas (56mm x 14.5mm x 42.5mm)
T36038	ND
T38415	Acero Poleas/Lisa (70mm x 10mm x 25mm)
T38484	EUR
T41001	Plastica Lisa (72mm x 11mm x 24mm) - Flanged
T41002	Acero Poleas/Lisa (62mm x 10mm x 35mm)
T41005	Steel Cog (47mm x N/A x 30mm)
T41005	Steel Cog (47mm x N/A x 30mm)
T41007	Acero Poleas/Lisa (48mm x 9mm x 32mm) - W/Bolt, Washer, Lock Washer, Nut
T41008	Plastica Lisa (85mm x Slotted x 30mm)
T41011	Acero Poleas/Lisa (57mm x Slotted x 26mm)
T41013	Acero Poleas/Lisa (70mm x Slotted x 19mm)
T41014	Acero Poleas/Lisa (62mm x Slotted x 27mm)

**GATES: LA MARCA DE MÁS PRESTIGIO EN BANDAS, MANGUERAS,  
HIDRÁULICA Y NEUMÁTICA.**

## Productos Gates \* FORMAS Y DIMENSIONES

No. Parte	Dimensiones
T41015	Acero Poleas/Lisa (65mm x Slotted x 32mm)
T41016	Acero Poleas/Lisa (55mm x Slotted x 30mm)
T41020	Acero Poleas/Lisa (55mm x Slotted x 24mm)
T41021	Acero Poleas/Lisa (55mm x Slotted x 32mm)
T41022	Acero Poleas/Lisa (70mm x Slotted x 19mm)
T41023	Acero Poleas/Lisa (53mm x Slotted x 26mm)
T41024	Acero Poleas/Lisa (55mm x N/A x 28mm)
T41028	Acero Poleas/Lisa (60mm x 30mm x 36mm) - W/Bushing, Bolt, 2 Washers, Lock Washer
T41031	Acero Poleas/Lisa (52mm x Slotted x 25mm)
T41037	Acero Poleas/Lisa (60mm x N/A x 28.5mm) - C/Bridas
T41038	Acero Poleas/Lisa (55mm x 8.5mm x 18.5mm) - Flanged
T41039	Acero Poleas/Lisa (60mm x 10mm x 35mm)
T41044	Acero Poleas/Lisa (60mm x N/A x 29mm) - Flanged
T41048	Acero Poleas/Lisa (60mm x Slotted x 32mm)
T41054	Acero Poleas/Lisa (60mm x 10mm x 33mm) - Flanged
T41058	Acero Poleas/Lisa (60mm x 8.5mm x 26mm) - C/Bridas
T41059	Acero Poleas/Lisa (60mm x 10mm x 30mm)
T41064	Plastica Lisa (58mm x 8.2mm x 25mm)
T41065	Acero Poleas/Lisa (51mm x 8mm x 28mm)
T41067	Acero Poleas/Lisa (57.5mm x ranurado x 29mm)
T41070	Acero Poleas/Lisa (57.5mm x ranurado x 29mm)
T41075	Acero Poleas/Lisa (62mm x 8.1mm x 36.5mm)
T41078	Acero Poleas/Lisa (62mm x 8.1mm x 36.5mm)
T41079	Acero Poleas/Lisa (72mm x 10.3mm x 25.4mm) - C/Bridas
T41084	Acero Poleas/Lisa (62mm x 10mm x 35mm) - C/Perno
T41085	Acero Poleas/Lisa (60mm x 10mm x 36mm)
T41090	Acero Poleas/Lisa (55mm x 10.1mm x 30mm)
T41098	Acero Poleas/Lisa (62mm x 10mm x 34mm) - W/Bushing, Bolt, Washer
T41107	Acero Poleas/Lisa (71mm x 10.3mm x 30mm) - C/Bridas
T41204	Acero Poleas/Lisa (62mm x 12mm x 40mm) - C/Actuador hidráulico
T41212	Acero Poleas/Lisa (57.5mm x 34mm)
T41228	Acero Poleas/Lisa (58mm x 10.1mm x 36mm) - Flanged
T41229	Acero Poleas/Lisa (40mm x 8mm x 36mm)
T41230	Acero Poleas/Lisa (28mm x 8mm x 34mm)
T41232	Acero Poleas/Lisa (55mm x 19mm x 24mm)
T41237	EUR
T41241	EUR

**GATES: LA MARCA DE MÁS PRESTIGIO EN BANDAS, MANGUERAS,  
HIDRÁULICA Y NEUMÁTICA.**

# Guía de Tensores DriveAlign® y PowerGrip®

Listado por número de parte

No. Parte	Dimensiones
T42002	Acero Poleas/Lisa (70mm x 10.4mm x 38mm)
T42005	Acero Poleas/Lisa (52mm x 10.5mm x 25mm)
T42016	Acero Poleas/Lisa (55mm x 10.3mm x 25mm)
T42017	Acero Poleas/Lisa (60mm x 10.5mm x 32mm)
T42018	Acero Poleas/Lisa (57.5mm x 10.3mm x 38mm) - Flanged
T42019	Acero Poleas/Lisa (28mm x 10mm x 27mm) - W/Bolt
T42020	Acero Poleas/Lisa (60mm x 10.5mm x 36mm)
T42021	Acero Poleas/Lisa (50mm x 10.5mm x 36mm)
T42023	Acero Poleas/Lisa (60mm x 10.5mm x 35mm)
T42024	Steel Cog (60mm x 10.5mm x 35mm)
T42024	Steel Cog (60mm x 10.5mm x 35mm)
T42025	Acero Poleas/Lisa (57.5mm x 12mm x 29mm)
T42030	Acero Poleas/Lisa (62mm x 12mm x 36.5mm)
T42031	Acero Poleas/Lisa (66mm x 12mm x 37.5mm)
T42032	Plastica Lisa (48mm x 10.4mm x 29mm)
T42033	Plastica Lisa (60mm x 10.4mm x 28.5mm)
T42034	Termoplástico Poleas/Lisa (47mm x 17mm x 29mm)
T42035	Termoplástico Poleas/Lisa (70mm x 10.4mm x 29mm)
T42036	Termoplástico Poleas/Lisa (60mm x 10.4mm x 29mm) - C/Separador
T42038	Acero Poleas/Lisa (55mm x 19.2mm x 30mm)
T42061	EUR
T42115	Acero Poleas/Lisa (60mm x 10mm x 36mm)
T42121	Acero Poleas/Lisa (58mm x N/A x 35.2mm) - C/Perno
T42166	EUR
T43001	Acero Poleas/Lisa (67mm x 9mm x 33mm)
T43003	Termoplástico Poleas/Lisa (60mm x 8mm x 30mm)
T43004	Acero Poleas/Lisa (65mm x 8.5mm x 32mm)
T43005	Acero Poleas/Lisa (70mm x 8.5mm x 32mm)
T43006	Plastica Lisa (67mm x 8mm x 30mm) - Flanged
T43007	Acero Poleas/Lisa (67mm x 8mm x 30mm) - C/Bridas
T43008	Acero Poleas/Lisa (67mm x 8mm x 33mm)
T43010	Acero Poleas/Lisa (72mm x 8mm x 30mm) - C/Bridas
T43016	Acero Poleas/Lisa (72mm x 18mm x 30mm) - Flanged, C/Perno, Bushing, Bolt, Washer
T43017	Acero Poleas/Lisa (72mm x 10mm x 30mm) - Flanged, W/Bushing, Bolt

**GATES: LA MARCA DE MÁS PRESTIGIO EN BANDAS, MANGUERAS, HIDRÁULICA Y NEUMÁTICA.**



## Productos Gates \* FORMAS Y DIMENSIONES

No. Parte	Dimensiones
T43023	Acero Poleas/Lisa (70mm x 8mm x 30mm)
T43027	Actuador
T43029	Actuador
T43032	Sin Polea
T43039	Plastica Lisa (60.6mm x NA x 29.6mm) - C/Perno, Spring
T43064	Acero Poleas/Lisa (65.4mm x 8.1mm x 32mm)
T43066	Actuador
T43068	EUR
T43073	Actuador
T43091	Acero Poleas/Lisa (68mm x 8.2mm x 36mm) - C/Bridas, C/Resorte
T43095	Sin Polea
T43096	Sin Polea
T43097	Sin Polea
T43098	Sin Polea
T43131	Acero Poleas/Lisa (67mm x 9mm x 33mm)
T43132	Acero Poleas/Lisa (67mm x 8mm x 33mm) - C/Base
T43142	EUR
T43163	EUR
T43166	EUR
TMV-13001	Acero Poleas/Lisa (70mm x 15mm x 26mm)
TMV-14001	Acero Poleas/Lisa (76.2mm x 15mm x 35mm)
TMV-22001	Acero Poleas/Lisa (76.2mm x 15mm x 35mm) (Dos poleas lisas)
TMV-22002	Acero Polea/Ranurada ( 77.2mm x 15mm x 35mm) (Polea lisa y Polea Ranurada)
TMV-23001	Acero Polea/Lisa (70mm x 10.9mm x 22mm)
TPG-14001	Acero Polea/Lisa (59mm x 8mm x 22mm)
TPG-14002	Acero Polea/Lisa (59mm x 8mm x 26mm)
TPG-14003	Acero Polea/Lisa (59mm x 8mm x 19mm)
TPG-14004	Acero Polea/Lisa (59mm x 13.8mm x 22mm)
TPG-20001	Acero Polea/Lisa (59mm x 13mm x 22mm)
TPG-22001	Acero Polea/Lisa (73mm x 8mm x 27mm)
TPG-23001	Acero Polea/Lisa (62mm x 8mm x 22mm)

**GATES: LA MARCA DE MÁS PRESTIGIO EN BANDAS, MANGUERAS,  
HIDRÁULICA Y NEUMÁTICA.**

Productos Gates \* FORMAS Y DIMENSIONES



**Tabla de Aplicaciones de kits para bandas Micro-V® (Serpentín)**



Kit	Marca	Vehiculo	Motor	Años	Observaciones	Componentes
DBK050400	CHEVROLET	CAVALIER	4 CIL. 2.2 LTS.	2002-2005		2
DBK050400	CHEVROLET	HHR	4 CIL. 2.2 LTS.	2006-2007		2
DBK050400	CHEVROLET	HHR	4 CIL. 2.4 LTS.	2006-2007		2
DBK050478	CHEVROLET	ASTRA	4 CIL. 1.8 LTS.	2003-2000	C/AA Y D/H	2
DBK050570	CHEVROLET	ASTRA	4 CIL. 1.8 LTS.	2003-2000	S/AA	2
DBK050887	CHEVROLET	CAVALIER	4 CIL. 2.2 LTS.	1998-2002		3
DBK060570A	CHEVROLET	CHEVY (TODOS)	4 CIL. 1.6 L	2009-1995	SERPENTIN , S/AA	2
DBK060705	CHEVROLET	CHEVY (JOY-SWING-POP)	4 CIL. 1.6 L	2003-1995	SERPENTIN , C/AA	2
DBK060708	CHEVROLET	CHEVY C2	4 CIL. 1.6 L	2009-2004	SERPENTIN , C/AA	2
DBK060744	CHEVROLET	OPTRA	4 CIL. 2.0 LTS.	2006-2007		2
DBK060864A	CHEVROLET	MALIBU	V6 3.1 LTS.	2000-2003		3
DBK060864B	CHEVROLET	VENTURE	V6 3.4 LTS.	2000-2005		-2 3
DBK060882	CHEVROLET	MALIBU	V6 3.5 LTS.	2004-2006		3
DBK060950	CHEVROLET	BLAZER	V6 4.3 LTS.	2000-2005		3
DBK040551	CHRYSLER	PT CRUISER	4 CIL. 2.4 LTS.	2003-2007		2
DBK060806	DODGE	CARAVAN/VOYAGER	V6 3.0 LTS.	1996-2000		2
DBK060815B	DODGE	CARAVAN/VOYAGER	V6 3.0 LTS.	1991-1995		2
DBK060825	DODGE	CARAVAN/VOYAGER	V6 3.3 LTS.	2001-2007		3
DBK060825	DODGE	CARAVAN/VOYAGER	V6 3.8 LTS.	2001-2007		3
DBK060876	DODGE	RAM PICK-UP	V6 3.7 LTS.	2002-2007	1500 / 2500	2
DBK060876A	DODGE	RAM PICK-UP	V8 4.7 LTS.	2004-2007	1500 / 2500	3
DBK060882D	DODGE	RAM PICK-UP	V8 4.7 LTS.	2002-2003	1500 / 2500	3
DBK060966	DODGE	CARAVAN/VOYAGER	V6 3.3 LTS.	1996-2000	C/AA	2
DBK060966	DODGE	CARAVAN/VOYAGER	V6 3.8 LTS.	1996-2000	C/AA	2
DBK060980	DODGE	CARAVAN/VOYAGER	V6 3.3 LTS.	1991-1995	S/AA	2
DBK060988	DODGE	CARAVAN/VOYAGER	V6 3.3 LTS.	1996-2000	S/AA	2
DBK060988	DODGE	CARAVAN/VOYAGER	V6 3.8 LTS.	1996-2000	S/AA	2
DBK060990	DODGE	CARAVAN/VOYAGER	V6 3.3 LTS.	1991-1995	C/AA	2
DBK081102	DODGE	RAM 4000	V6 5.9 LTS. Diesel	2003-2007	S/AA	2

**GATES: LA MARCA DE MÁS PRESTIGIO EN BANDAS, MANGUERAS, HIDRÁULICA Y NEUMÁTICA.**

## Productos Gates \* FORMAS Y DIMENSIONES

Kit	Marca	Vehiculo	Motor	Años	Observaciones	Componentes
DBK081265	DODGE	RAM 4000	V6 5.9 LTS. Diesel	2003-2007	C/AA	2
DBK060507	FORD	ESCORT	4 CIL. 2.0 LTS.	1997-2000	SOHC C/AA	3
DBK060532	FORD	FOCUS	4 CIL. 2.0 LTS.	2000-2002	SOHC S/AA	2
DBK060623	FORD	CONTOUR	V6 2.5 LTS.	1995-2000	S/AA	2
DBK060667	FORD	FOCUS	4 CIL. 2.0 LTS.	2003-2004	SOHC C/AA	2
DBK060670	FORD	IKON , K Y FIESTA	4 CIL. 1.6 LTS.	2007-2000	S/AA	2
DBK060680	FORD	FOCUS	4 CIL. 2.0 LTS.	2000-2002	SOHC C/AA	2
DBK060682	FORD	CONTOUR	4 CIL. 2.0 LTS.	1995-1997	S/AA	3
DBK060695	FORD	RANGER	4 CIL. 2.3 LTS.	1995-1997	S/AA	2
DBK060721	FORD	CONTOUR	V6 2.5 LTS.	1995-2000	C/AA	2
DBK060721B	FORD	RANGER	4 CIL. 2.3 LTS.	1992-1994	S/AA	2
DBK060730	FORD	RANGER	4 CIL. 2.3 LTS.	2001-2006	S/AA	2
DBK060733	FORD	CONTOUR	4 CIL. 2.0 LTS.	1995-1997	C/AA	3
DBK060775	FORD	FOCUS	4 CIL. 2.0 LTS.	2000-2002	DOHC S/AA	2
DBK060802	FORD	CONTOUR	4 CIL. 2.0 LTS.	1998-2000	S/AA	2
DBK060806B	FORD	AEROSTAR	V6, 3.0 LTS.	1995-1997	S/AA	3
DBK060810	FORD	AEROSTAR	V6, 4.0 LTS.	1990-1995	S/AA	3
DBK060820	FORD	RANGER	4 CIL. 2.3 LTS.	1995-1997	C/AA	2
DBK060820A	FORD	WINDSTAR	V6, 3.0 LTS.	1995-2000	S/AA	3
DBK060820C	FORD	ESCAPE	4 CIL. 2.3 LTS.	2001-2004	C/AA	2
DBK060827	FORD	FOCUS	4 CIL. 2.0 LTS.	2003-2004	DOHC C/AA	2
DBK060827	FORD	CONTOUR	4 CIL. 2.0 LTS.	1998-2000	C/AA	2
DBK060827B	FORD	RANGER	4 CIL. 2.3 LTS.	2001-2006	C/AA	2
DBK060837	FORD	FOCUS	4 CIL. 2.0 LTS.	2000-2002	DOHC C/AA	2
DBK060837B	FORD	RANGER	4 CIL. 2.3 LTS.	1992-1994	C/AA	2
DBK060840	FORD	ESCAPE	4 CIL. 2.3 LTS.	2005-2006		2
DBK060849	FORD	WINDSTAR	V6, 3.0 LTS.	1995-2000	C/AA	3
DBK060854	FORD	ESCORT	4 CIL. 2.0 LTS.	1997-2000	DOHC	3
DBK060864C	FORD	AEROSTAR	V6, 4.0 LTS.	1995-1997	C/AA	3
DBK060868B	FORD	AEROSTAR	V6, 4.0 LTS.	1990-1995	C/AA	3
DBK060882E	FORD	IKON , K Y FIESTA	4 CIL. 1.6 LTS.	2007-2000	C/AA	2
DBK060960	FORD	FREESTAR	V6, 3.9 LTS.	2004-2007		2
DBK060960A	FORD	WINDSTAR	V6, 3.8 LTS.	1999-2003		3
DBK061066	FORD	AEROSTAR	V6, 3.0 LTS.	1995-1997	C/AA	3
DBK060458	HONDA	ODYSSEY	V6, 3.5 LTS.	1999-2004		2
DBK060461	HONDA	ACCORD	V6, 3.0 LTS.	1998-2002	ALT. / AA	2
DBK060750	JEEP	WRANGLER	6 CIL. 4.0 L	2005-2003	SERPENTIN , S/AA	3

**GATES: LA MARCA DE MÁS PRESTIGIO EN BANDAS, MANGUERAS,  
HIDRÁULICA Y NEUMÁTICA.**

## Productos Gates \* FORMAS Y DIMENSIONES

Kit	Marca	Vehiculo	Motor	Años	Observaciones	Componentes
DBK060750A	JEEP	WRANGLER	V-6, 4.0 L	2004-2004	SERPENTIN , S/AA	3
DBK060790	JEEP	WRANGLER	6 CIL, 4.0 L	2002-1999	SERPENTIN, S/AA	2
DBK060815	JEEP	GRAND CHEROKEE	V-8, 6.1 LTS.	2006-2007	SERPENTIN, C/AA	3
DBK060820B	JEEP	GRAND CHEROKEE	V-8, 5.7 LTS.	2005-2007	SERPENTIN, C/AA	3
DBK060868	JEEP	LIBERTY	V-6, 3.7 L	2004-2006	SERPENTIN	2
DBK060868A	JEEP	GRAND CHEROKEE	V-8, 4.7 L	2004-2007	SERPENTIN, C/AA	3
DBK060868A	JEEP	GRAND CHEROKEE	6 CIL, 3.7 LTS.	2005-2007	SERPENTIN, C/AA	3
DBK060874	JEEP	LIBERTY	V-6, 3.7 L	2002-2003	SERPENTIN, C/AA	2
DBK060874A	JEEP	GRAND CHEROKEE 4 X 4	V-8, 4.7 L	1999-2003	SERPENTIN, C/AA	3
DBK060882A	JEEP	GRAND CHEROKEE	6 CIL, 4.0 L	1999-2004	SERPENTIN, S/AA	3
DBK060882C	JEEP	WRANGLER	6 CIL, 4.0 L	2005-2000	SERPENTIN , C/AA	3
DBK060882C	JEEP	WRANGLER	V-6, 4.0 L	2004-2004	SERPENTIN , C/AA	3
DBK060919	JEEP	WRANGLER	4 CIL, 2.4 L	2004-2003	SERPENTIN, C/AA	3
DBK060755	LINCOLN	LINCOLN CONTINENTAL	V-8, 4.6 L	2002-1998	SERPENTIN	2
DBK060975	LINCOLN	MARK VIII	V-8, 4.6 L	1998-1998	SERPENTIN	3
DBK060975	LINCOLN	TOWN CAR	V-8, 4.6 L	1999-1999	SERPENTIN	3
DBK060984	LINCOLN	NAVIGATOR	V-8, 5.4 L	2002-2002	SERPENTIN	3
DBK070855	LINCOLN	LINCOLN TOWN CAR	V-8, 4.6 L	1992-1991	SERPENTIN	3
DBK080981	LINCOLN	NAVIGATOR	V-8, 5.4 L	2001-2001	SERPENTIN	3
DBK080981	LINCOLN	NAVIGATOR	V-8, 5.4 L	2000-1998	SERPENTIN, C/AA, C/DH	3
DBK060942	MERCEDES BENZ	CLK430	V-8, 4.3 L	2002-1999	SERPENTIN	2
DBK060942	MERCEDES BENZ	CLK55	V-8, 5.5 L	2001-2001	SERPENTIN	2
DBK060942	MERCEDES BENZ	E320	V-6, 3.2 L	2002-1998	SERPENTIN	2
DBK060942	MERCEDES BENZ	E430	V-8, 4.3 L	2001-1999	SERPENTIN	2
DBK060942	MERCEDES BENZ	E55	V-8, 5.5 L	2001-1999	SERPENTIN	2
DBK060942	MERCEDES BENZ	ML	V-6, 3.2 L	1998-1998	SERPENTIN	2
DBK060942	MERCEDES BENZ	ML430	V-8, 4.3 L	2001-1999	SERPENTIN	2
DBK060942	MERCEDES BENZ	ML55	V-8, 5.5 L	2001-2000	SERPENTIN	2
DBK060942	MERCEDES BENZ	S430	V-8, 4.3 L	2002-2000	SERPENTIN	2
DBK060942	MERCEDES BENZ	S500	V-8, 5.0 L	2001-1999	SERPENTIN	2
DBK060942	MERCEDES BENZ	S500 L	V-8, 5.0 L	2000-1998	SERPENTIN	2
DBK060942	MERCEDES BENZ	S55	V-8, 5.5 L	2001-2001	SERPENTIN	2
DBK060942	MERCEDES BENZ	C240	V-6, 2.6 L	2002-2001	SERPENTIN	2
DBK060942	MERCEDES BENZ	C280T	V-6, 2.8 L	1998-1998	SERPENTIN	2
DBK060942	MERCEDES BENZ	C320	V-6, 3.2 L	2001-2001	SERPENTIN	2
DBK060942	MERCEDES BENZ	CL500	V-8, 5.0 L	2001-1999	SERPENTIN	2
DBK060942	MERCEDES BENZ	CL55	V-8, 5.5 L	2001-2001	SERPENTIN	2

**GATES: LA MARCA DE MÁS PRESTIGIO EN BANDAS, MANGUERAS, HIDRÁULICA Y NEUMÁTICA.**

## Productos Gates \* FORMAS Y DIMENSIONES

Kit	Marca	Vehiculo	Motor	Años	Observaciones	Componentes
DBK060942A	MERCEDES BENZ	ML320	V-6, 3.2 L	2002-1999	SERPENTIN	3
DBK060942A	MERCEDES BENZ	SL500	V-8, 5.0 L	2001-1999	SERPENTIN	3
DBK060942A	MERCEDES BENZ	C280	V-6, 2.8 L	1999-1998	SERPENTIN	3
DBK060942A	MERCEDES BENZ	C43	V-8, 4.3 L	2000-1999	SERPENTIN	3
DBK060942A	MERCEDES BENZ	CLK320	V-6, 3.2 L	2002-1999	SERPENTIN	3
DBK060623A	MERCURY	MYSTIQUE	V-6, 2.5 L, DURATEC, DOHC	2000-1995	SERPENTIN, S/AA	3
DBK060682	MERCURY	MYSTIQUE	4 CIL, 2.0 L, ZETEC, DOHC	1997-1996	SERPENTIN, S/AA	3
DBK060716	MERCURY	MYSTIQUE	V-6, 2.5 L, DURATEC, DOHC	2000-1995	SERPENTIN, C/AA	3
DBK060721A	MERCURY	MYSTIQUE	V-6, 2.5 L, DURATEC, DOHC	2000-1997	SERPENTIN, C/AA	3
DBK060733	MERCURY	MYSTIQUE	4 CIL, 2.0 L, ZETEC, DOHC	1997-1996	SERPENTIN, C/AA	3
DBK060802A	MERCURY	MYSTIQUE	4 CIL, 2.0 L, ZETEC, DOHC	2000-1999	SERPENTIN, S/AA	3
DBK060815C	MERCURY	SABLE	V-6, 3.0 L	2003-2001	SERPENTIN , C/AA 24V.	2
DBK060827A	MERCURY	MYSTIQUE	4 CIL, 2.0 L, ZETEC, DOHC	2000-1999	SERPENTIN, C/AA	3
DBK060832	MERCURY	MYSTIQUE	4 CIL, 2.0 L, ZETEC, DOHC	1998-1998	SERPENTIN, C/AA >FEB 1998	3
DBK060854A	MERCURY	SABLE	V-6, 3.0 L, OHV	2000-1999	SERPENTIN 12 V.	3
DBK060854A	MERCURY	SABLE	V-6, 3.0 L, DURATEC, DOHC	1999-1999	SERPENTIN, C/AA	3
DBK060854B	MERCURY	SABLE	V-6, 3.0 L, OHV	2000-2000	SERPENTIN	3
DBK060858	MERCURY	SABLE	V-6, 3.0 L, OHV	2002-2001	SERPENTIN, S/motor HV	2
DBK060858	MERCURY	SABLE	V-6, 3.0 L, DURATEC, SOHC	1998-1998	SERPENTIN OHV	2
DBK060858	MERCURY	SABLE LS	V-6, 3.0 L, DURATEC, OVH	2001-2000	SERPENTIN	2
DBK060858A	MERCURY	MYSTIQUE	4 CIL, 2.0 L, ZETEC, DOHC	1998-1998	SERPENTIN, C/AA, < ENE	3
DBK060975	MERCURY	GRAND MARQUIS	V-8, 4.6 L	1999-1995	SERPENTIN	3
DBK070855	MERCURY	GRAND MARQUIS	V-8, 4.6 L	1994-1992	SERPENTIN, ALT. C/86 3/8"	3
DBK050435	NISSAN	PLATINA	4 CIL, 1.6 L	2002-2008	S/AA	2
DBK050688	NISSAN	PLATINA	4 CIL, 1.6 L	2002-2008	c/AA	2
DBK060883	NISSAN	ALTIMA	4 CIL, 2.4 L	2004-2003	SERPENTIN	2
DBK060883	NISSAN	SENTRA	4 CIL, 2.5 L	2004-2003	SERPENTIN	2
DBK060695B	OLDSMOBILE	SILHOUETTE	V-6, 3.1 L	1993-1992	SERPENTIN	2
DBK060938	OLDSMOBILE	LSS	V-6, 3.8 L	1999-1999	SERPENTIN	2
DBK061025	OLDSMOBILE	SILHOUETTE	V-6, 3.8 L	1994-1993	SERPENTIN, ALT.105 Amp	2
DBK060420	PEUGEOT	306	4 CIL, 2.0 L, XU10J4R	2001-1999	SERPENTIN, S/AA	2
DBK060425B	PEUGEOT	306	4 CIL, 1.8 L, XU7JP4	2001-1999	SERPENTIN, S/AA	2
DBK060570	PEUGEOT	206	4 CIL, 1.6 L, TU5JP4	2001-1999	SERPENTIN, S/AA	2
DBK060615	PEUGEOT	206	4 CIL, 1.4 L	2004-1999	SERPENTIN, C/AA & C/DH	2
DBK060615	PEUGEOT	206	4 CIL, 1.6 L	2004-1999	SERPENTIN, C/AA & C/DH	2
DBK060630	PEUGEOT	306	4 CIL, 2.0 L, XU10J4R	2001-1999	SERPENTIN, C/AA	2
DBK060653	PEUGEOT	306	4 CIL, 1.8 L, XU7JP4	2001-1999	SERPENTIN, C/AA	3

**GATES: LA MARCA DE MÁS PRESTIGIO EN BANDAS, MANGUERAS, HIDRÁULICA Y NEUMÁTICA.**

## Productos Gates \* FORMAS Y DIMENSIONES

Kit	Marca	Vehiculo	Motor	Años	Observaciones	Componentes
DBK040410	PONTIAC	TRANS AM FIREBIRD	V-8, 5.7 L	2001-1998	SERPENTIN, A.A.	2
DBK050345	PONTIAC	SUNFIRE	4 CIL, 2.2 L	2004-2004	SERPENTIN S/AA	3
DBK050345	PONTIAC	G5	4-Cyl. 2.4 L	2005-2007	S/AA	3
DBK050400	PONTIAC	SUNFIRE	4 CIL, 2.2 LTS.	2002-2005		2
DBK050400A	PONTIAC	SUNFIRE	4 CIL, 2.2 L	2005-2005	SERPENTIN	3
DBK050400A	PONTIAC	SUNFIRE	4 CIL, 2.2 L, MOTOR # SERIE F	2002-2002	SERPENTIN, C/AA; Motor # serie F	3
DBK050400A	PONTIAC	SUNFIRE	4 CIL, 2.2 L	2004-2004	SERPENTIN C/AA	3
DBK050400A	PONTIAC	G5	4-Cyl. 2.2 L	2005-2007	C/AA	3
DBK050405	PONTIAC	G6	4-Cyl. 2.4 L	2005-2007		3
DBK050474	PONTIAC	SUNFIRE	4 CIL, 2.4 L, MFI PRIMER DISEÑO	1999-1996	SERPENTIN	3
DBK050630	PONTIAC	SUNFIRE	4 CIL, 2.2 L	2002-1998	SERPENTIN, S/AA; Motor # de serie 4	3
DBK050705	PONTIAC	SUNFIRE	4 CIL, 2.2 L, MFI	1997-1995	SERPENTIN, S/AA	3
DBK050835	PONTIAC	SUNFIRE	4 CIL, 2.2 L, MFI	1997-1995	SERPENTIN, C/AA	3
DBK050887	PONTIAC	SUNFIRE	4 CIL, 2.2 L, MOTOR SERIE 4	2002-1998	SERPENTIN, C/AA; Motor serie 4	3
DBK050887	PONTIAC	SUNFIRE	4 CIL, 2.2 LTS.	1998-2002		3
DBK060642	PONTIAC	TRANS AM FIREBIRD	V-8, 5.7 L	1997-1995	SERPENTIN	2
DBK060721C	PONTIAC	BONNEVILLE SSE	V-6, 3.8 L	1999-1998	SERPENTIN - SUPERCARGADOR	3
DBK060790B	PONTIAC	TRANS AM FIREBIRD	V-8, 5.7 L	2001-1998	SERPENTIN ACCESORIOS	2
DBK060864	PONTIAC	AZTEK	V-6, 3.4 L	2005-2001	SERPENTIN	2
DBK060864B	PONTIAC	MONTANA	V-6 3.4 L	2005-2003	C/105A ALT.	3
DBK060875	PONTIAC	MONTANA	V-6 3.4 L	2005-2003	C/130A ALT.	3
DBK060888	PONTIAC	MONTANA	V-6 3.5 L	2006-2005		3
DBK060905	PONTIAC	TORRENT	V-6 3.4 L	2006-2006		3
DBK060935	PONTIAC	G6	V-6 3.6 L	2007-2007		3
DBK060938A	PONTIAC	BONNEVILLE SSE	V-6, 3.8 L	1999-1998	SERPENTIN	3
DBK050435	RENAULT	CLIO / KANGOO	4 CIL, 1.6 L	2002-2008	S/AA	2
DBK050688	RENAULT	CLIO / KANGOO	4 CIL, 1.6 L	2002-2008	c/AA	2
DB6DPK1200	SEAT	LEON	4 CIL, 1.8 L, TURBO	2003-2003	SERPENTIN , ALT., C/AA	2
DB6DPK1200	SEAT	TOLEDO	4 CIL, 1.8 L	2003-2003	SERPENTIN , ALT., C/AA	2
DBK060295	SEAT	IBIZA	4 CIL, 1.6L	2005-2003	SERPENTIN , S/AA, C/DH	2
DBK060365	SEAT	IBIZA	4 CIL, 2.0 L	2005-2003	SERPENTIN , S/AA	2
DBK060367	SEAT	CORDOBA	4 CIL, 2.0 L	2004-2004	SERPENTIN , ALT. S/AA	2
DBK060406	SEAT	IBIZA	4 CIL, 2.0 L	2005-2003	SERPENTIN , C/AA	2
DBK060408	SEAT	CORDOBA	4 CIL, 2.0 L	2004-2004	SERPENTIN , ALT. C/AA	2
DBK060425	SEAT	CORDOBA	4 CIL, 1.6 L	2005-2001	SERPENTIN , ALT. C/AA	2
DBK060425	SEAT	IBIZA	4 CIL, 1.6L	2005-2003	SERPENTIN , C/AA, C/DH	2
DBK060445	SEAT	LEON	4 CIL, 1.8 L, TURBO	2003-2003	SERPENTIN , ALT., S/AA	2

**GATES: LA MARCA DE MÁS PRESTIGIO EN BANDAS, MANGUERAS, HIDRÁULICA Y NEUMÁTICA.**

## Productos Gates \* FORMAS Y DIMENSIONES

Kit	Marca	Vehiculo	Motor	Años	Observaciones	Componentes
DBK060445	SEAT	TOLEDO	4 CIL, 1,8 L	2003-2003	SERPENTIN , ALT., S/AA	2
DB6DPK1200	VOLKSWAGEN	SHARAN	4 CIL, 1,8 L	2003-2006	SERPENTIN , C/AA	2
DB6DPK1200A	VOLKSWAGEN	BEETLE	4 CIL, 1,8 L	2005-2000	SERPENTIN , C/AA, C/BANDA DE DOBLE PERFIL	3
DB6DPK1200A	VOLKSWAGEN	BEETLE	4 CIL, 2,0 L	2005-2000	SERPENTIN , C/AA	3
DB6DPK1200A	VOLKSWAGEN	GOLF	4 CIL, 1,8 L, TURBO	2005-2001	SERPENTIN , C/AA	3
DB6DPK1200A	VOLKSWAGEN	GOLF	4 CIL, 2,0 L	2005-2000	SERPENTIN , C/AA	3
DB6DPK1200A	VOLKSWAGEN	JETTA	4 CIL, 1,8 L	2005-2000	SERPENTIN	3
DB6DPK1200A	VOLKSWAGEN	JETTA	4 CIL, 2,0 L	2005-1999	SERPENTIN , C/AA	3
DB7DPK1360	VOLKSWAGEN	JETTA	V-6, 2,8 L	2004-1999	SERPENTIN , C/BANDA DE DOBLE PERFIL, C/7 COSTILLAS	2
DBK050510	VOLKSWAGEN	PASSAT	4 CIL, 1,8 L, DOHC TURBO	2005-1999	SERPENTIN , P/ALT, DIR. HIDR. Y VENT.	3
DBK060297	VOLKSWAGEN	POLO	4 CIL, 1,6 L	2003-2006	SERPENTIN , S/AA	2
DBK060355	VOLKSWAGEN	CABRIO	4 CIL, 2,0 L, MPFI	1995-1995	SERPENTIN , ALT. & B.A. S/AA, S/ALT. 120A	3
DBK060365B	VOLKSWAGEN	PANEL	4 CIL, 1,8 L	2001-1996	SERPENTIN , ALT., C/RAD	2
DBK060385	VOLKSWAGEN	CABRIO	4 CIL, 2,0 L, MPFI	2002-1995	SERPENTIN , B.A. & ALT., S/AA	3
DBK060385	VOLKSWAGEN	GOLF	4 CIL, 2,0 L, MPFI	2000-1999	BANDA B.A. & ALT., S/AA; S/BANDA DE DOBLE PERFIL	3
DBK060385	VOLKSWAGEN	JETTA	4 CIL, 2,0 L	1994-1994	SERPENTIN , ALT. & B.A. S/AA, C/ALT 120A	3
DBK060385	VOLKSWAGEN	JETTA	4 CIL, 2,0 L	2000-1999	SERPENTIN , ALT. & B.A. S/AA	3
DBK060406	VOLKSWAGEN	POLO	4 CIL, 2,0 L	2003-2006	SERPENTIN , C/AA	2
DBK060408A	VOLKSWAGEN	JETTA	4 CIL, 2,0 L	2000-1996	SERPENTIN , ALT., S/AA, S/DH	3
DBK060420B	VOLKSWAGEN	LUPO	4 CIL, 1,6 L	2006-2004	SERPENTIN , C/DH Y S/AA	2
DBK060424	VOLKSWAGEN	POLO	4 CIL, 1,6 L	2003-2006	SERPENTIN , C/AA	2
DBK060441	VOLKSWAGEN	GOLF	4 CIL, 2,0 L	2005-2003	SERPENTIN , S/AA	3
DBK060454	VOLKSWAGEN	CABRIO GL, GLS	4 CIL, 2,0 L, MPFI	2000-2000	SERPENTIN , ALT., C/AA, C/DH	3
DBK060455	VOLKSWAGEN	CABRIO	4 CIL, 2,0 L, MPFI	2002-1995	BANDA ALT. & A.A.	3
DBK060455	VOLKSWAGEN	JETTA	4 CIL, 2,0 L	2000-2000	BANDA ALT. & A.A., S/MICRO V DE DOBLE PERFIL	3
DBK060455B	VOLKSWAGEN	VW VAN	4 CIL, 1,6 L	2003-2006	SERPENTIN , C/AA	2
DBK060669	VOLKSWAGEN	LUPO	4 CIL, 1,6 L	2006-2004	SERPENTIN , C/DH Y C/AA	2
DBK060683	VOLKSWAGEN	POINTER	4 CIL, 1,8 L	2001-2008	SERPENTIN , ALT., S/AA	2
DBK060683	VOLKSWAGEN	POINTER PICK-UP	4 CIL, 1,8 L	2005-2008	SERPENTIN , S/AA	2
DBK060739	VOLKSWAGEN	JETTA	V-6, 2,8 L	2002-2002	SERPENTIN , S/AA	2
DBK060894	VOLKSWAGEN	POINTER	4 CIL, 1,8 L, MFI	2001-2008	SERPENTIN , C/AA, C/DH	2
DBK060894	VOLKSWAGEN	POINTER PICK-UP	4 CIL, 1,8 L, MFI	2001-1999	SERPENTIN , C/AA, C/DH	2
DBK060894	VOLKSWAGEN	POINTER STATION WAGON	4 CIL, 1,8 L, MFI	2001-1999	SERPENTIN , C/AA, C/DH	2

**GATES: LA MARCA DE MÁS PRESTIGIO EN BANDAS, MANGUERAS, HIDRÁULICA Y NEUMÁTICA.**

## Kits para bandas Micro-V® DriveAlign®

Componentes iguales a los de equipo original:

- Tensor con resorte helicoidal DriveAlign®, eliminan el ruido, la vibración y el desgaste de la transmisión.



- Banda Micro-V® AT con la mejor tecnología del mercado (Más silenciosa y mayor duración).



**GATES: LA MARCA DE MÁS PRESTIGIO EN BANDAS, MANGUERAS, HIDRÁULICA Y NEUMÁTICA.**





## Tabla de Aplicaciones de kits para PowerGrip®



Kit	Marca	Vehiculo	Motor	Años	Observaciones	Componentes
TCK184	ACURA	INTEGRA	4 CIL, 1.8 L	1999-2001		2
TCK193	ACURA	TL	V-6, 3.2 L	1998-1998		2
TCK247	ACURA	INTEGRA	4 CIL, 1.8 L	2001-1999	C/VTEC MOTOR.	2
TCK286	ACURA	TL	V-6, 3.2 L	2000-1999		3
TCK244	ACURA	CL	4 CIL, 2.3 L	1998-1999		4
TCK297	AUDI	A8	V-8, 4.2 L	2007-2007		3
TCK285	CADILLAC	CATERA	V-6, 3.0 L	1998-1999		4
TCK285A	CADILLAC	CATERA	V-6, 3.0 L	2000-1999	Late	4
TCK1022	CHEVROLET	ASTRA	4 CIL, 2.0 L	2004-2005		2
TCK1022	CHEVROLET	ZAFIRA	4 CIL, 2.0 L	2005-2006		2
TCK164	CHEVROLET	TRACKER	4 CIL, 1.6 L	1991-1992		2
TCK212	CHEVROLET	TRACKER	4 CIL, 1.6 L	2001-2002		2
TCK305	CHEVROLET	ASTRA	4 CIL, 2.4 L	2006-2004		2
TCK305	CHEVROLET	ZAFIRA	4 CIL, 2.4 L	2006-2004		2
TCK203	CHEVROLET	CHEVY	4 CIL, 1.6 L	1999-1997		3
TCK203	CHEVROLET	CHEVY C2	4 CIL, 1.6 L	2007-2004		3
TCK203	CHEVROLET	CHEVY C2 SEDAN	4 CIL, 1.6 L	2007-2006		3
TCK203	CHEVROLET	CHEVY JOY	4 CIL, 1.6 L	2000-1998		3
TCK203	CHEVROLET	CHEVY PICK-UP	4 CIL, 1.6 L	2002-2004		3
TCK203	CHEVROLET	CHEVY POP	4 CIL, 1.6 L	1998-1996		3
TCK203	CHEVROLET	CHEVY SWING	4 CIL, 1.6 L	2000-1997		3
TCK203	CHEVROLET	MONZA	4 CIL, 1.6 L	2002-1994		3
TCK192	CHEVROLET	LUMINA	V-6, 3.4 L	1993-1991		4
TCK273	CHEVROLET	LUMINA	V-6, 3.4 L	1996-1997		4
TCK1094	CHEVROLET	ASTRA	4 CIL, 1.8 L	2000-2003		4
TCK1094	CHEVROLET	ZAFIRA	4 CIL, 1.8 L	2003-2001		4
TCK309	CHEVROLET	OPTRA	4 CIL, 2.0 L	2008-2006		4
TCK139	CHRYSLER	DAYTONA	V-6, 3.0 L	1993-1990		2
TCK139	CHRYSLER	GRAND VOYAGER	V-6, 3.0 L	1996-2001		2
TCK139	CHRYSLER	GRAND VOYAGER	V-6, 3.3 L	2000-2000		2
TCK139	CHRYSLER	LEBARON	V-6, 3.0 L	1991-1990		2

**GATES: LA MARCA DE MÁS PRESTIGIO EN BANDAS, MANGUERAS, HIDRÁULICA Y NEUMÁTICA.**

## Productos Gates \* FORMAS Y DIMENSIONES

Kit	Marca	Vehiculo	Motor	Años	Observaciones	Componentes
TCK139	CHRYSLER	TOWN & COUNTRY VAN	V-6, 3.0 L	1990-1990		2
TCK139	CHRYSLER	VOYAGER	V-6, 3.0 L	1997-2000		2
TCK153	CHRYSLER	DAYTONA	4 CIL, 2.2 L	1990-1990		2
TCK153	CHRYSLER	DAYTONA	4 CIL, 2.5 L	1990-1993		2
TCK153	CHRYSLER	LEBARON	4 CIL, 2.2 L	1990-1990		2
TCK153	CHRYSLER	LEBARON	4 CIL, 2.5 L	1993-1992		2
TCK219	CHRYSLER	CONCORDE	V-6, 3.5 L	1993-1994		2
TCK219	CHRYSLER	INTREPID	V-6, 3.5 L	1994-1993		2
TCK219	CHRYSLER	LHS	V-6, 3.5 L	1994-1994		2
TCK219	CHRYSLER	NEW YORKER	V-6, 3.5 L	1994-1994		2
TCK245	CHRYSLER	CIRRUS	4 CIL, 2.0 L	2000-2000	C/Hyd. TENSOR	2
TCK255	CHRYSLER	CONCORDE	V-6, 3.5 L	1997-1995		2
TCK255	CHRYSLER	INTREPID	V-6, 3.5 L	1997-1995		2
TCK255	CHRYSLER	LHS	V-6, 3.5 L	1995-1997		2
TCK255	CHRYSLER	NEW YORKER	V-6, 3.5 L	1995-1996		2
TCK295	CHRYSLER	300M	V-6, 3.5 L	2002-1999		2
TCK295	CHRYSLER	CONCORDE	V-6, 3.2 L	2001-2000		2
TCK295	CHRYSLER	CONCORDE	V-6, 3.5 L	2002-2002		2
TCK295	CHRYSLER	INTREPID	V-6, 3.2 L	1999-1998		2
TCK295	CHRYSLER	INTREPID	V-6, 3.5 L	2000-2001		2
TCK295	CHRYSLER	LHS	V-6, 3.5 L	2000-1999		2
TCK246	CHRYSLER	SEBRING	4 CIL, 2.0 L	1995-1999	C/DOHC MOTOR.; C/Hyd. TENSOR	3
TCK259	CHRYSLER	CIRRUS	V-6, 2.5 L	1998-1999		3
TCK259	CHRYSLER	SEBRING	V-6, 2.5 L	1998-1997		3
TCK259	CHRYSLER	SEBRING	V-6, 3.0 L	2004-2001		3
TCK139	DODGE	CARAVAN	V-6, 3.0 L	1993-1995		2
TCK139	DODGE	GRAND CARAVAN	V-6, 3.0 L	1992-2001		2
TCK139	DODGE	SPIRIT	V-6, 3.0 L	1995-1994		2
TCK153	DODGE	CARAVAN	4 CIL, 2.5 L	1995-1995		2
TCK153	DODGE	DAKOTA	4 CIL, 2.5 L	1995-1995		2
TCK153	DODGE	SHADOW	4 CIL, 2.2 L	1994-1994		2
TCK153	DODGE	SHADOW	4 CIL, 2.5 L	1994-1994		2
TCK153	DODGE	SPIRIT	4 CIL, 2.5 L	1994-1995		2
TCK245	DODGE	NEON	4 CIL, 2.0 L	1996-2002	C/Hyd. TENSOR	2
TCK245	DODGE	STRATUS	4 CIL, 2.0 L	1995-2000		2
TCK255	DODGE	INTREPID	V-6, 3.5 L	1996-1997		2
TCK295	DODGE	INTREPID	V-6, 3.2 L	1998-2001		2

**GATES: LA MARCA DE MÁS PRESTIGIO EN BANDAS, MANGUERAS,  
HIDRÁULICA Y NEUMÁTICA.**

## Productos Gates \* FORMAS Y DIMENSIONES

Kit	Marca	Vehiculo	Motor	Años	Observaciones	Componentes
TCK295	DODGE	INTREPID	V-6, 3.5 L	2000-2002		2
TCK246	DODGE	NEON	4 CIL, 2.0 L	1998-1999	C/DOHC MOTOR.; C/Hyd. TENSOR	3
TCK259	DODGE	STRATUS	V-6, 2.5 L	1997-1999		3
TCK259	DODGE	STRATUS	V-6, 3.0 L	2004-2001		3
TCK194	FORD	ESCORT	4 CIL, 1.9 L	1996-1994		2
TCK210	FORD	RANGER	4 CIL, 2.3 L	1994-1994		2
TCK276	FORD	RANGER	4 CIL, 2.3 L	1995-2001		2
TCK276	FORD	RANGER	4 CIL, 2.5 L	2001-2000		2
TCK283	FORD	ESCORT	4 CIL, 2.0 L	1998-1997		2
TCK283	FORD	FOCUS	4 CIL, 2.0 L	2004-2001		2
TCK179	FORD	ESCORT	4 CIL, 1.8 L	1996-1994		3
TCK283	FORD	ESCORT	4 CIL, 2.0 L	2002-1997	C/SOHC MOTOR.	3
TCK294B	FORD	ESCAPE	4 CIL, 2.0 L	2002-2004		3
TCK258	FORD	CONTOUR	4 CIL, 2.0 L	1997-1995		4
TCK294	FORD	CONTOUR	4 CIL, 2.0 L	1998-1999		4
TCK294	FORD	ESCORT	4 CIL, 2.0 L	1998-2000		4
TCK294A	FORD	CONTOUR	4 CIL, 2.0 L	1999-2000		4
TCK294A	FORD	ESCORT	4 CIL, 2.0 L	2000-1999		4
TCK294A	FORD	FOCUS	4 CIL, 2.0 L	2000-2006		4
TCK294A	FORD	ZX2	4 CIL, 2.0 L	2003-2003		4
TCK250	FORD	CONTOUR	4 CIL, 2.0 L	1997-1997	Motor de interferencia	2
TCK143	HONDA	CIVIC	4 CIL, 1.5 L	1995-1995		2
TCK143	HONDA	CIVIC DEL SOL	4 CIL, 1.5 L	1995-1995		2
TCK184	HONDA	CR-V	4 CIL, 2.0 L	2001-1999		2
TCK224	HONDA	CIVIC	4 CIL, 1.6 L	1997-1995	C/SOHC MOTOR.	2
TCK224	HONDA	CIVIC DEL SOL	4 CIL, 1.6 L	1997-1996		2
TCK227	HONDA	CIVIC	4 CIL, 1.6 L	2000-1999		2
TCK227	HONDA	CIVIC DEL SOL	4 CIL, 1.6 L	1997-1995		2
TCK221	HONDA	PASSPORT	V-6, 3.2 L	1997-1997		3
TCK286	HONDA	ACCORD	V-6, 3.0 L	2000-2001		3
TCK186	HONDA	ACCORD	4 CIL, 2.2 L	1996-1997		4
TCK186	HONDA	ODYSSEY	4 CIL, 2.2 L	1996-1997		4
TCK244	HONDA	ACCORD	4 CIL, 2.2 L	1995-1996		4
TCK244	HONDA	ACCORD	4 CIL, 2.3 L	1998-1999		4
TCK244	HONDA	ODYSSEY	4 CIL, 2.3 L	1998-1998		4
TCK1013M	HYUNDAI	ATOS	4 CIL, 1.0 L	2004-2000		2
TCK1013M	HYUNDAI	ATOS	4 CIL, 1.1 L	2008-2005		2

**GATES: LA MARCA DE MÁS PRESTIGIO EN BANDAS, MANGUERAS, HIDRÁULICA Y NEUMÁTICA.**

## Productos Gates \* FORMAS Y DIMENSIONES

Kit	Marca	Vehiculo	Motor	Años	Observaciones	Componentes
TCK124M	HYUNDAI	H100	4 CIL, 2.4 L	2005-2003		2
TCK324M	HYUNDAI	ACCENT	4 CIL, 1.5 L	2003-2000		2
TCK324M	HYUNDAI	ACCENT	4 CIL, 1.6 L	2006-2001		2
TCK324M	HYUNDAI	ATTITUD	4 CIL, 1.6 L	2007-2006		2
TCK324M	HYUNDAI	ATTITUDE	4 CIL, 1.6 L	2007-2006		2
TCK324M	HYUNDAI	VERNA	4 CIL, 1.5 L	2007-2004		2
TCK324M	HYUNDAI	VERNA	4 CIL, 1.6 L	2006-2005		2
TCK282M	HYUNDAI	ACCENT	4 CIL, 1.5 L	2003-2000		3
TCK282M	HYUNDAI	ACCENT	4 CIL, 1.6 L	2006-2001		3
TCK282M	HYUNDAI	ATTITUD	4 CIL, 1.6 L	2007-2006		3
TCK282M	HYUNDAI	ATTITUDE	4 CIL, 1.6 L	2007-2006		3
TCK282M	HYUNDAI	VERNA	4 CIL, 1.5 L	2007-2004		3
TCK282M	HYUNDAI	VERNA	4 CIL, 1.6 L	2006-2005		3
TCK282M	HYUNDAI	ACCENT	4 CIL, 1.6 L	2006-2001		3
TCK179	MAZDA	MX-5 MIATA	4 CIL, 1.8 L	2005-2005		3
TCK258	MERCURY	MYSTIQUE	4 CIL, 2.0 L	1996-1997		4
TCK294	MERCURY	MYSTIQUE	4 CIL, 2.0 L	1998-1999		4
TCK294A	MERCURY	COUGAR	4 CIL, 2.0 L	1999-2003		4
TCK294A	MERCURY	MYSTIQUE	4 CIL, 2.0 L	1999-2000		4
TCK259	MITSUBISHI	ECLIPSE	V-6, 3.0 L	2005-2000		3
TCK259	MITSUBISHI	GALANT	V-6, 3.0 L	2000-2003		3
TCK259	MITSUBISHI	MONTERO SPORT	V-6, 3.0 L	2000-2003		3
TCK287	MITSUBISHI	DIAMANTE	V-6, 3.5 L	2000-2004		3
TCK287	MITSUBISHI	ENDEAVOR	V-6, 3.8 L	2006-2004		3
TCK287	MITSUBISHI	GALANT	V-6, 3.8 L	2004-2006		3
TCK287	MITSUBISHI	MONTERO	V-6, 3.5 L	2000-2000		3
TCK287	MITSUBISHI	MONTERO SPORT	V-6, 3.5 L	2000-2002		3
TCK104	NISSAN	MAXIMA	V-6, 3.0 L	1990-1994	C/Square Tooth Sprockets	2
TCK104	NISSAN	PATHFINDER	V-6, 3.0 L	1990-1991		2
TCK104	NISSAN	PICK-UP	V-6, 3.0 L	1992-1990		2
TCK104	NISSAN	QUEST	V-6, 3.0 L	1994-1993		2
TCK249	NISSAN	FRONTIER	V-6, 3.3 L	1999-2001	Motor de interferencia	2
TCK249	NISSAN	MAXIMA	V-6, 3.0 L	1994-1993		2
TCK249	NISSAN	PATHFINDER	V-6, 3.0 L	1994-1995		2
TCK249	NISSAN	PATHFINDER	V-6, 3.3 L	1996-1997		2
TCK249	NISSAN	PICK-UP	V-6, 3.0 L	1993-1995		2
TCK249	NISSAN	QUEST	6 CIL, 3.3 L	2002-2002		2

**GATES: LA MARCA DE MÁS PRESTIGIO EN BANDAS, MANGUERAS,  
HIDRÁULICA Y NEUMÁTICA.**

## Productos Gates \* FORMAS Y DIMENSIONES

Kit	Marca	Vehiculo	Motor	Años	Observaciones	Componentes
TCK249	NISSAN	QUEST	V-6, 3.0 L	1994-1998		2
TCK249	NISSAN	QUEST	V-6, 3.3 L	2002-2000		2
TCK249	NISSAN	XTERRA	V-6, 3.3 L	2004-2000		2
TCK1095	NISSAN	APRIO	4 CIL, 1.6 L	2008-2008		4
TCK1095	NISSAN	PLATINA	4 CIL, 1.6 L	2004-2008		4
TCK1095M	NISSAN	APRIO	4 CIL, 1.6 L	2008-2008		4
TCK1095M	NISSAN	PLATINA	4 CIL, 1.6 L	2003-2007		4
TCK1095M	NISSAN	APRIO	4 CIL, 1.6 L	2008-2008		4
TCK1095M	NISSAN	PLATINA	4 CIL, 1.6 L	2008-2002		4
TCK901	PEUGEOT	206	4 CIL, 1.4 L	2001-1998	108 Dientes y 17mm de Ancho	2
TCK901A	PEUGEOT	206	4 CIL, 1.4 L	2003-2008	104 Dientes y 17mm de Ancho	2
TCK192	PONTIAC	GRAND PRIX	V-6, 3.4 L	1995-1995		4
TCK273	PONTIAC	GRAND PRIX	V-6, 3.4 L	1996-1996		4
TCK1284	RENAULT	MEGAN I	4 CIL, 2.0 L	2001-2003		2
TCK1565	RENAULT	MEGAN II	4 CIL, 2.0 L	2005-2006		2
TCK1095M	RENAULT	CLIO	4 CIL, 1.6 L	2003-2008		4
TCK1095M	RENAULT	KANGOO	4 CIL, 1.6 L	2006-2005		4
TCK1095M	RENAULT	KANGOO EXPRESS	4 CIL, 1.6 L	2005-2007		4
TCK1095M	RENAULT	CLIO	4 CIL, 1.6 L	2008-2003		4
TCK1095M	RENAULT	KANGOO	4 CIL, 1.6 L	2008-2005		4
TCK1095M	RENAULT	KANGOO EXPRESS	4 CIL, 1.6 L	2008-2005		4
TCK285	SAAB	09-May	V6, 3.0 L	2002-2003		4
TCK285	SAAB	09-May	V-6, 3.0 L	2000-2003		4
TCK1548	SEAT	CORDOBA	4 CIL, 1.6 L	2007-2004		2
TCK1548	SEAT	IBIZA	4 CIL, 1.6 L	2006-2003		2
TCK199	TOYOTA	CAMRY	4 CIL, 2.2 L	2000-2001		3
TCK199	TOYOTA	CAMRY SOLARA	4 CIL, 2.2 L	2000-2000		3
TCK199	TOYOTA	RAV 4	4 CIL, 2.0 L	2000-2000		3
TCK199	TOYOTA	SOLARA	4 CIL, 2.2 L	2001-2001		3
TCK257	TOYOTA	AVALON	V-6, 3.0 L	2000-2004		3
TCK257	TOYOTA	CAMRY	V-6, 3.0 L	2002-2000		3
TCK257	TOYOTA	CAMRY SOLARA	V-6, 3.0 L	2000-2000		3
TCK257	TOYOTA	SIENNA	V-6, 3.0 L	2003-2002		3
TCK257	TOYOTA	SOLARA	V-6, 3.0 L	2002-2001		3
TCK271	TOYOTA	4 RUNNER	V-6, 3.4 L	2000-1997		3
TCK271	TOYOTA	T100	V-6, 3.4 L	1998-1998		3
TCK271	TOYOTA	TACOMA	V-6, 3.4 L	2001-2003		3

**GATES: LA MARCA DE MÁS PRESTIGIO EN BANDAS, MANGUERAS,  
HIDRÁULICA Y NEUMÁTICA.**

## Productos Gates \* FORMAS Y DIMENSIONES

Kit	Marca	Vehiculo	Motor	Años	Observaciones	Componentes
TCK271	TOYOTA	TUNDRA	V-6, 3.4 L	2000-2002		3
TCK298	TOYOTA	LAND CRUISER	V-8, 4.7 L	2007-2007		3
TCK298	TOYOTA	TUNDRA	V-8, 4.7 L	2007-2008		3
TCK017	VOLKSWAGEN	GOLF	4 CIL, 1.8 L	1995-1995		2
TCK017	VOLKSWAGEN	GOLF GTI SPECIAL	4 CIL, 1.8 L	1992-1992		2
TCK017	VOLKSWAGEN	JETTA	4 CIL, 1.8 L	1990-1992		2
TCK017	VOLKSWAGEN	JETTA GL	4 CIL, 1.8 L	1991-1992		2
TCK017	VOLKSWAGEN	JETTA GLI	4 CIL, 1.8 L	1990-1991		2
TCK1548	VOLKSWAGEN	CROSSFOX	4 CIL, 1.6 L	2008-2005		2
TCK1548	VOLKSWAGEN	LUPO	4 CIL, 1.6 L	2006-2008		2
TCK1548	VOLKSWAGEN	POLO	4 CIL, 1.6 L	2007-2005		2
TCK1548	VOLKSWAGEN	SPORT VAN	4 CIL, 1.6 L	2007-2006		2
TCK1548	VOLKSWAGEN	SPORTVAN	4 CIL, 1.6 L	2008-2006		2
TCK260M	VOLKSWAGEN	CABRIO	4 CIL, 2.0 L	1995-1995		2
TCK260M	VOLKSWAGEN	CABRIO	4 CIL, 2.0 L	2002-1996		2
TCK260M	VOLKSWAGEN	DERBY	4 CIL, 1.8 L	2008-2005		2
TCK260M	VOLKSWAGEN	GOLF	4 CIL, 2.0 L	1996-1995		2
TCK260M	VOLKSWAGEN	GOLF	4 CIL, 2.0 L	1999-1999		2
TCK260M	VOLKSWAGEN	GOLF	4 CIL, 2.0 L	2000-2000		2
TCK260M	VOLKSWAGEN	GOLF	4 CIL, 2.0 L	1998-1997		2
TCK260M	VOLKSWAGEN	JETTA	4 CIL, 2.0 L	1996-1995		2
TCK260M	VOLKSWAGEN	JETTA	4 CIL, 2.0 L	1999-1999		2
TCK260M	VOLKSWAGEN	JETTA	4 CIL, 2.0 L	2000-2000		2
TCK260M	VOLKSWAGEN	JETTA	4 CIL, 2.0 L	1998-1997		2
TCK260M	VOLKSWAGEN	PASSAT	4 CIL, 2.0 L	1996-1995		2
TCK260M	VOLKSWAGEN	POINTER	4 CIL, 1.8 L	2008-1998		2
TCK262	VOLKSWAGEN	CABRIO	4 CIL, 2.0 L	1996-1995		2
TCK262	VOLKSWAGEN	GOLF	4 CIL, 2.0 L	1995-1997		2
TCK262	VOLKSWAGEN	GTI	4 CIL, 2.0 L	2000-1999		2
TCK262	VOLKSWAGEN	JETTA	4 CIL, 2.0 L	2000-1995		2
TCK262	VOLKSWAGEN	PASSAT	4 CIL, 2.0 L	1995-1996		2
TCK262A	VOLKSWAGEN	CABRIO	4 CIL, 2.0 L	1996-1996		2
TCK296	VOLKSWAGEN	BEETLE	4 CIL, 2.0 L	1998-2000	Nvo. estilo; C/Banda doble cara	2
TCK296	VOLKSWAGEN	GOLF	4 CIL, 2.0 L	1999-2003		2
TCK296	VOLKSWAGEN	JETTA	4 CIL, 2.0 L	1999-2008		2
TCK739M	VOLKSWAGEN	EUROVAN	5 CIL, 2.5 L	2002-2000		2
TCK333M	VOLKSWAGEN	BORA	4 CIL, 1.9 L DIESEL	2007-2007		3

**GATES: LA MARCA DE MÁS PRESTIGIO EN BANDAS, MANGUERAS,  
HIDRÁULICA Y NEUMÁTICA.**

## Productos Gates \* FORMAS Y DIMENSIONES

Kit	Marca	Vehiculo	Motor	Años	Observaciones	Componentes
TCK333M	VOLKSWAGEN	EUROVAN	4 CIL, 1.9 L	2008-2007		3
TCK333M	VOLKSWAGEN	EUROVAN	4 CIL, 1.9 L DIESEL	2008-2005		3
TCK333M	VOLKSWAGEN	EUROVAN	4 CIL, 1.9 L DIESEL	2006-2006		3
TCK333M	VOLKSWAGEN	JETTA	4 CIL, 1.9 L DIESEL	2007-2005		3
TCK333M	VOLKSWAGEN	BORA	4 CIL, 1.9 L DIESEL	2007-2007		3
TCK333M	VOLKSWAGEN	EUROVAN	4 CIL, 1.9 L	2008-2007		3
TCK333M	VOLKSWAGEN	EUROVAN	4 CIL, 1.9 L DIESEL	2007-2006		3
TCK333M	VOLKSWAGEN	EUROVAN	4 CIL, 1.9 L DIESEL	2008-2008		3
TCK333M	VOLKSWAGEN	EUROVAN	4 CIL, 1.9 L DIESEL	2005-2005		3
TCK333M	VOLKSWAGEN	JETTA	4 CIL, 1.9 L DIESEL	2005-2005		3
TCK333M	VOLKSWAGEN	JETTA	4 CIL, 1.9 L DIESEL	2007-2006		3
TCK321	VOLKSWAGEN	JETTA	4 CIL, 1.9 L DIESEL	2001-2003		5

**GATES: LA MARCA DE MÁS PRESTIGIO EN BANDAS, MANGUERAS,  
HIDRÁULICA Y NEUMÁTICA.**

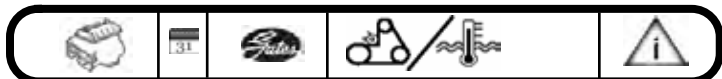

# ACURA

## CL

4 CIL. 2.3 L	1999	T41014	TENSOR- POLEA DE DIST.	
		T41013	TENSOR- POLEA DE DIST.	
V6. 3.0 L	1999	38001	POLEA	ALT. Y.A.A.
		38169	TENSOR PARA BANDA MICRO-V	ALT. Y.A.A.
4 CIL. 2.2 L	1997	T41013	TENSOR- POLEA DE DIST.	BALANCIN
		T41014	TENSOR- POLEA DE DIST.	

## EL

4 CIL. 1.6 L	2000	TCKWP224	KIT DE DISTRIBUCION CON B.A.	
4 CIL. 1.6 L	1999	TCKWP224	KIT DE DISTRIBUCION CON B.A.	
4 CIL. 1.6 L	1998	TCKWP224	KIT DE DISTRIBUCION CON B.A.	
4 CIL. 1.6 L	1997	TCKWP224	KIT DE DISTRIBUCION CON B.A.	

## INTEGRA

4 CIL. 1.8 L	2001	TCKWP184	KIT DE DISTRIBUCION CON B.A.	
		T41016	TENSOR- POLEA DE DIST.	
4 CIL. 1.8 L	2000	TCKWP184	KIT DE DISTRIBUCION CON B.A.	
4 CIL. 1.8 L	1999	TCKWP184	KIT DE DISTRIBUCION CON B.A.	
		38030	POLEA	A.A.
4 CIL. 1.8 L	1998	TCKWP184	KIT DE DISTRIBUCION CON B.A.	
		T41016	TENSOR- POLEA DE DIST.	
4 CIL. 1.8 L	1997	TCKWP184	KIT DE DISTRIBUCION CON B.A.	
		T41016	TENSOR- POLEA DE DIST.	
4 CIL. 1.8 L	1996	T41016	TENSOR- POLEA DE DIST.	
4 CIL. 1.8 L	1995	TCKWP184A	KIT DE DISTRIBUCION CON B.A.	
		T41016	TENSOR- POLEA DE DIST.	
4 CIL. 1.8 L	1994	TCKWP184A	KIT DE DISTRIBUCION CON B.A.	
		T41016	TENSOR- POLEA DE DIST.	
4 CIL. 1.7 L	1993	T41016	TENSOR- POLEA DE DIST.	
4 CIL. 1.8 L	1993	TCKWP184A	KIT DE DISTRIBUCION CON B.A.	
		T41016	TENSOR- POLEA DE DIST.	
4 CIL. 1.7 L	1992	T41016	TENSOR- POLEA DE DIST.	
4 CIL. 1.8 L	1992	TCKWP184A	KIT DE DISTRIBUCION CON B.A.	
		T41016	TENSOR- POLEA DE DIST.	
4 CIL. 1.8 L	1991	TCKWP184A	KIT DE DISTRIBUCION CON B.A.	
4 CIL. 1.8 L	1990	TCKWP184A	KIT DE DISTRIBUCION CON B.A.	
4 CIL. 1.6 L	1989	T41018	TENSOR- POLEA DE DIST.	
4 CIL. 1.6 L	1988	T41018	TENSOR- POLEA DE DIST.	
4 CIL. 1.6 L	1987	T41018	TENSOR- POLEA DE DIST.	
4 CIL. 1.6 L	1986	T41018	TENSOR- POLEA DE DIST.	

## LEGEND

V6. 3.2 L	1995	TCKWP193	KIT DE DISTRIBUCION CON B.A.	
		T41021	TENSOR- POLEA DE DIST.	
V6. 3.2 L	1994	TCKWP193	KIT DE DISTRIBUCION CON B.A.	
		T41021	TENSOR- POLEA DE DIST.	
V6. 3.2 L	1993	TCKWP193	KIT DE DISTRIBUCION CON B.A.	
		T41021	TENSOR- POLEA DE DIST.	
V6. 3.2 L	1992	TCKWP193	KIT DE DISTRIBUCION CON B.A.	
		T41021	TENSOR- POLEA DE DIST.	
V6. 3.2 L	1991	TCKWP193	KIT DE DISTRIBUCION CON B.A.	

## MDX

V6. 3.7 L	2010	TCK329	KIT DE DISTRIBUCION	
		36112	POLEA	
		37008P	POLEA DECOPLADORA	
		38332	TENSOR	
		T41232	TENSOR- POLEA DE DIST.	
		T41231	TENSOR- POLEA DE DIST.	
		T43129	TENSOR- POLEA DE DIST.	
V6. 3.7 L	2009	TCK329	KIT DE DISTRIBUCION	
		36112	POLEA	

V6. 3.7 L	2008	37008P	POLEA DECOPLADORA	
		38332	TENSOR	
		T43129	TENSOR- POLEA DE DIST.	
		T41231	TENSOR- POLEA DE DIST.	
		T41232	TENSOR- POLEA DE DIST.	
		TCK329	KIT DE DISTRIBUCION	
		36112	POLEA	
		37008P	POLEA DECOPLADORA	
		38332	TENSOR	
		T41231	TENSOR- POLEA DE DIST.	
		T41232	TENSOR- POLEA DE DIST.	
		T41231	TENSOR- POLEA DE DIST.	POLEA TENSORA
		T43129	TENSOR- POLEA DE DIST.	HIDRAULICO
		T43129	TENSOR- POLEA DE DIST.	
V6. 3.7 L	2007	TCK329	KIT DE DISTRIBUCION	
		36112	POLEA	
		37008P	POLEA DECOPLADORA	
		38332	TENSOR	
		T43129	TENSOR- POLEA DE DIST.	HIDRAULICO
		T41231	TENSOR- POLEA DE DIST.	POLEA
		T41231	TENSOR- POLEA DE DIST.	
		T41232	TENSOR- POLEA DE DIST.	
		T43129	TENSOR- POLEA DE DIST.	
		TCK329	KIT DE DISTRIBUCION	
		36112	POLEA	
		36112	POLEA	
		37008P	POLEA DECOPLADORA	
		37008P	POLEA DECOPLADORA	
		38332	TENSOR	
		38332	TENSOR PARA BANDA MICRO-V	
		T41231	TENSOR- POLEA DE DIST.	POLEA
		T41231	TENSOR- POLEA DE DIST.	
		T43129	TENSOR- POLEA DE DIST.	
		T41232	TENSOR- POLEA DE DIST.	
		T43129	TENSOR- POLEA DE DIST.	HIDRAULICO
V6. 3.5 L	2006	T41231	TENSOR- POLEA DE DIST.	POLEA
		T43129	TENSOR- POLEA DE DIST.	
V6. 3.5 L	2005	T41231	TENSOR- POLEA DE DIST.	HIDRAULICO
		T43129	TENSOR- POLEA DE DIST.	POLEA
V6. 3.5 L	2004	T41231	TENSOR- POLEA DE DIST.	HIDRAULICO
		T43129	TENSOR- POLEA DE DIST.	POLEA
V6. 3.5 L	2003	T43129	TENSOR- POLEA DE DIST.	HIDRAULICO
		T41231	TENSOR- POLEA DE DIST.	POLEA
V6. 3.5 L	2002	38327	TENSOR PARA BANDA MICRO-V	ALT. Y.A.A.

## RDX

4 CIL. 2.3 L	2010	38278	TENSOR	
4 CIL. 2.3 L	2009	38278	TENSOR	
4 CIL. 2.3 L	2008	38278	TENSOR	
4 CIL. 2.3 L	2007	38278	TENSOR	
4 CIL. 2.3 L	2006	38278	TENSOR	

## RL

V6. 3.7 L	2010	TCK329	KIT DE DISTRIBUCION	
		36112	POLEA	
		38332	TENSOR	
		T43129	TENSOR- POLEA DE DIST.	
		T41232	TENSOR- POLEA DE DIST.	
		T41231	TENSOR- POLEA DE DIST.	
V6. 3.7 L	2009	TCK329	KIT DE DISTRIBUCION	
		36112	POLEA	
		38332	TENSOR	
		T43129	TENSOR- POLEA DE DIST.	
		T41232	TENSOR- POLEA DE DIST.	
		T41231	TENSOR- POLEA DE DIST.	
V6. 3.5 L	2008	TCK329	KIT DE DISTRIBUCION	
		36112	POLEA	
		37008P	POLEA DECOPLADORA	
		38332	TENSOR	
		T41232	TENSOR- POLEA DE DIST.	
		T43129	TENSOR- POLEA DE DIST.	HIDRAULICO
		T41231	TENSOR- POLEA DE DIST.	POLEA TENSORA
		T41231	TENSOR- POLEA DE DIST.	



V6, 3.5 L	2008	T43129	TENSOR- POLEA DE DIST.			36112	POLEA	
V6, 3.5 L	2007	TCK329	KIT DE DISTRIBUCION			T41231	TENSOR- POLEA DE DIST.	
		36112	POLEA			T43129	TENSOR- POLEA DE DIST.	
		37008P	POLEA DECOPLADORA		V6, 3.7 L	T41232	TENSOR- POLEA DE DIST.	
		38332	TENSOR		2010	TCK329	KIT DE DISTRIBUCION	
		T43129	TENSOR- POLEA DE DIST.			36112	POLEA	
		T41231	TENSOR- POLEA DE DIST.	HIDRAULICO		T43129	TENSOR- POLEA DE DIST.	
		T43129	TENSOR- POLEA DE DIST.	POLEA		T41231	TENSOR- POLEA DE DIST.	
		T41231	TENSOR- POLEA DE DIST.		V6, 3.5 L	T41232	TENSOR- POLEA DE DIST.	
		T41232	TENSOR- POLEA DE DIST.		2009	TCK329	KIT DE DISTRIBUCION	
V6, 3.5 L	2006	TCK329	KIT DE DISTRIBUCION			TCKWP329	KIT DE DISTRIBUCION CON B.A.	
		36112	POLEA			36112	POLEA	
		37008P	POLEA DECOPLADORA			T41232	TENSOR- POLEA DE DIST.	
		38332	TENSOR		V6, 3.7 L	T43129	TENSOR- POLEA DE DIST.	
		T41231	TENSOR- POLEA DE DIST.		2009	T41231	TENSOR- POLEA DE DIST.	
		T41232	TENSOR- POLEA DE DIST.			T41232	TENSOR- POLEA DE DIST.	
		T43129	TENSOR- POLEA DE DIST.	HIDRAULICO		TCK329	KIT DE DISTRIBUCION	
		T43129	TENSOR- POLEA DE DIST.	HIDRAULICO		36112	POLEA	
V6, 3.5 L	2005	T43129	TENSOR- POLEA DE DIST.			T41231	TENSOR- POLEA DE DIST.	
V6, 3.5 L	2004	TCKWP279	KIT DE DISTRIBUCION CON B.A.		4 CIL. 3.2 L	T43129	TENSOR- POLEA DE DIST.	
		T41219	TENSOR- POLEA DE DIST.	BALANCIN	V6, 3.2 L	T41232	TENSOR- POLEA DE DIST.	
		T42144	TENSOR- POLEA DE DIST.		2008	TCK329	KIT DE DISTRIBUCION	
V6, 3.5 L	2003	TCKWP279	KIT DE DISTRIBUCION CON B.A.			36112	POLEA	
		T41219	TENSOR- POLEA DE DIST.	BALANCIN		38332	TENSOR	
		T42144	TENSOR- POLEA DE DIST.			T43129	TENSOR- POLEA DE DIST.	HIDRAULICO
V6, 3.5 L	2002	TCKWP279	KIT DE DISTRIBUCION CON B.A.			T41231	TENSOR- POLEA DE DIST.	POLEA TENSORA
		T42144	TENSOR- POLEA DE DIST.			T41231	TENSOR- POLEA DE DIST.	
		T41219	TENSOR- POLEA DE DIST.	BALANCIN		T41232	TENSOR- POLEA DE DIST.	
V6, 3.5 L	2001	TCKWP279	KIT DE DISTRIBUCION CON B.A.		V6, 3.5 L	T43129	TENSOR- POLEA DE DIST.	
		T42144	TENSOR- POLEA DE DIST.		2008	TCK329	KIT DE DISTRIBUCION	
		T41219	TENSOR- POLEA DE DIST.	BALANCIN		TCKWP329	KIT DE DISTRIBUCION CON B.A.	
V6, 3.5 L	2000	TCKWP279	KIT DE DISTRIBUCION CON B.A.			36112	POLEA	
		T41219	TENSOR- POLEA DE DIST.	BALANCIN		38332	TENSOR	
		T42144	TENSOR- POLEA DE DIST.			T43129	TENSOR- POLEA DE DIST.	HIDRAULICO
V6, 3.5 L	1999	TCKWP279	KIT DE DISTRIBUCION CON B.A.			T43129	TENSOR- POLEA DE DIST.	
		T41219	TENSOR- POLEA DE DIST.	BALANCIN		T41231	TENSOR- POLEA DE DIST.	POLEA TENSORA
		T42144	TENSOR- POLEA DE DIST.			T41231	TENSOR- POLEA DE DIST.	
V6, 3.5 L	1998	TCKWP279	KIT DE DISTRIBUCION CON B.A.		4 CIL. 3.2 L	T41232	TENSOR- POLEA DE DIST.	
		T41219	TENSOR- POLEA DE DIST.	BALANCIN	V6, 3.2 L	TCKWP329	KIT DE DISTRIBUCION CON B.A.	
		T42144	TENSOR- POLEA DE DIST.		2007	TCK329	KIT DE DISTRIBUCION	
V6, 3.5 L	1997	TCKWP279	KIT DE DISTRIBUCION CON B.A.			36112	POLEA	
		T41219	TENSOR- POLEA DE DIST.	BALANCIN		37008P	POLEA DECOPLADORA	
		T42144	TENSOR- POLEA DE DIST.			38332	TENSOR	
V6, 3.5 L	1996	TCKWP279	KIT DE DISTRIBUCION CON B.A.			T43129	TENSOR- POLEA DE DIST.	HIDRAULICO
		T41219	TENSOR- POLEA DE DIST.	BALANCIN		T41231	TENSOR- POLEA DE DIST.	POLEA
		T42144	TENSOR- POLEA DE DIST.			T41232	TENSOR- POLEA DE DIST.	
						T41231	TENSOR- POLEA DE DIST.	
						T43129	TENSOR- POLEA DE DIST.	
					V6, 3.5 L	TCKWP329	KIT DE DISTRIBUCION CON B.A.	
					2007	T41231	TENSOR- POLEA DE DIST.	POLEA TENSORA
						T43129	TENSOR- POLEA DE DIST.	HIDRAULICO
					2006	TCKWP329	KIT DE DISTRIBUCION CON B.A.	
					2006	TCK329	KIT DE DISTRIBUCION	
						36112	POLEA	
						37008P	POLEA DECOPLADORA	
						38332	TENSOR	
V6, 3.5 L	1998	T42115	TENSOR- POLEA DE DIST.	POLEA TENSORA		T43129	TENSOR- POLEA DE DIST.	HIDRAULICO
		T41028	TENSOR- POLEA DE DIST.			T43129	TENSOR- POLEA DE DIST.	POLEA
V6, 3.2 L	1997	TCKWP221	KIT DE DISTRIBUCION CON B.A.	HIDRAULICO		T41231	TENSOR- POLEA DE DIST.	
		T43095	TENSOR- POLEA DE DIST.			T41232	TENSOR- POLEA DE DIST.	
		T41028	TENSOR- POLEA DE DIST.			T41231	TENSOR- POLEA DE DIST.	
V6, 3.2 L	1996	TCKWP221	KIT DE DISTRIBUCION CON B.A.	POLEA TENSORA	4 CIL. 3.2 L	TCKWP329	KIT DE DISTRIBUCION CON B.A.	HIDRAULICO
		T42002	TENSOR- POLEA DE DIST.		V6, 3.2 L	T43129	TENSOR- POLEA DE DIST.	POLEA
		T43095	TENSOR- POLEA DE DIST.	POLEA TENSORA		T41231	TENSOR- POLEA DE DIST.	
		T41028	TENSOR- POLEA DE DIST.	HIDRAULICO	4 CIL. 3.2 L	TCKWP329	KIT DE DISTRIBUCION CON B.A.	HIDRAULICO
					V6, 3.2 L	T43129	TENSOR- POLEA DE DIST.	
					2004	T41090	TENSOR- POLEA DE DIST.	POLEA TENSORA
					2004	T42038	TENSOR- POLEA DE DIST.	
					2000	T42038	TENSOR- POLEA DE DIST.	
						T41090	TENSOR- POLEA DE DIST.	
						T41090	TENSOR- POLEA DE DIST.	
						T42038	TENSOR- POLEA DE DIST.	POLEA TENSORA

**SLX**

**TL**

5 CIL. 2.5 L	1998	TCKWP211 T41020	KIT DE DISTRIBUCION CON B.A. TENSOR- POLEA DE DIST.	
V6. 3.2 L	1998	TCKWP193A T41021 T41021	KIT DE DISTRIBUCION CON B.A. TENSOR- POLEA DE DIST. TENSOR- POLEA DE DIST.	
5 CIL. 2.5 L	1997	TCKWP211 T41020	KIT DE DISTRIBUCION CON B.A. TENSOR- POLEA DE DIST.	
V6. 3.2 L	1997	TCKWP193A T41021	KIT DE DISTRIBUCION CON B.A. TENSOR- POLEA DE DIST.	
5 CIL. 2.5 L	1996	TCKWP211 T41020	KIT DE DISTRIBUCION CON B.A. TENSOR- POLEA DE DIST.	
V6. 3.2 L	1996	TCKWP193A T41021	KIT DE DISTRIBUCION CON B.A. TENSOR- POLEA DE DIST.	
5 CIL. 2.5 L	1995	TCKWP211 T41020	KIT DE DISTRIBUCION CON B.A. TENSOR- POLEA DE DIST.	

V6. 3.0 L	2006	T43018 TCK330 38406 T43027 T41086 T41086 T42137 T42138 T42138 T42137 T43027	TENSOR- POLEA DE DIST. KIT DE DISTRIBUCION TENSOR TENSOR- POLEA DE DIST. TENSOR- POLEA DE DIST. TENSOR- POLEA DE DIST. TENSOR- POLEA DE DIST. TENSOR- POLEA DE DIST. TENSOR- POLEA DE DIST. TENSOR- POLEA DE DIST. TENSOR- POLEA DE DIST.	HIDRAULICO
V6. 3.2 L	2006	38423 38015	TENSOR TENSOR	POLEA TENSORA DER. POLEA TENSORA IZQ
4 CIL. 1.8 L	2005	TCKWP306A 38207 T43018 T43028 T42138 T41086 T42137 T43027	KIT DE DISTRIBUCION CON B.A. TENSOR TENSOR- POLEA DE DIST. TENSOR- POLEA DE DIST. TENSOR- POLEA DE DIST. TENSOR- POLEA DE DIST. TENSOR- POLEA DE DIST. TENSOR- POLEA DE DIST.	HIDRAULICO POLEA TENSORA DER.
V6. 3.0 L	2005	T42138 T41086 T42137 T43027	TENSOR- POLEA DE DIST. TENSOR- POLEA DE DIST. TENSOR- POLEA DE DIST. TENSOR- POLEA DE DIST.	POLEA TENSORA IZQ HIDRAULICO
4 CIL. 1.8 L	2004	TCKWP306A 38207 T43018 T43028 T43027 T42137 T42138 T41086	KIT DE DISTRIBUCION CON B.A. TENSOR TENSOR- POLEA DE DIST. TENSOR- POLEA DE DIST. TENSOR- POLEA DE DIST. TENSOR- POLEA DE DIST. TENSOR- POLEA DE DIST. TENSOR- POLEA DE DIST.	HIDRAULICO HIDRAULICO POLEA TENSORA IZQ POLEA TENSORA DER.
V6. 3.0 L	2004	T43018 T43028 T43027 T42137 T42138 T41086	TENSOR- POLEA DE DIST. TENSOR- POLEA DE DIST. TENSOR- POLEA DE DIST. TENSOR- POLEA DE DIST. TENSOR- POLEA DE DIST. TENSOR- POLEA DE DIST.	HIDRAULICO HIDRAULICO POLEA TENSORA IZQ POLEA TENSORA DER.
4 CIL. 1.8 L	2003	TCKWP306A 38207 T43028 T43018 T42138 T41086 T42137 T43027	KIT DE DISTRIBUCION CON B.A. TENSOR TENSOR- POLEA DE DIST. TENSOR- POLEA DE DIST. TENSOR- POLEA DE DIST. TENSOR- POLEA DE DIST. TENSOR- POLEA DE DIST. TENSOR- POLEA DE DIST.	HIDRAULICO ALTERNADOR ALTERNADOR HIDRAULICO
V6. 3.0 L	2003	T42138 T41086 T42137 T43027	TENSOR- POLEA DE DIST. TENSOR- POLEA DE DIST. TENSOR- POLEA DE DIST. TENSOR- POLEA DE DIST.	POLEA TENSORA DER. POLEA TENSORA IZQ HIDRAULICO
4 CIL. 1.8 L	2002	TCKWP306A 38151 38151 T43028 T43018 T42137 T43027 T42138 T41086	KIT DE DISTRIBUCION CON B.A. TENSOR TENSOR PARA BANDA MICRO-V TENSOR- POLEA DE DIST. TENSOR- POLEA DE DIST. TENSOR- POLEA DE DIST. TENSOR- POLEA DE DIST. TENSOR- POLEA DE DIST. TENSOR- POLEA DE DIST.	HIDRAULICO ALTERNADOR ALTERNADOR HIDRAULICO
V6. 3.0 L	2002	T42137 T43027 T42138 T41086	TENSOR- POLEA DE DIST. TENSOR- POLEA DE DIST. TENSOR- POLEA DE DIST. TENSOR- POLEA DE DIST.	POLEA TENSORA IZQ HIDRAULICO POLEA TENSORA DER.
4 CIL. 1.8 L	2001	TCKWP306A 38068 38068 38151 T43018 T43028	KIT DE DISTRIBUCION CON B.A. POLEA TENSOR TENSOR TENSOR- POLEA DE DIST. TENSOR- POLEA DE DIST.	A.A. A.A. HIDRAULICO
V6. 2.8 L	2001	TCKWP297 38193 T41227 T41082 T43026	KIT DE DISTRIBUCION CON B.A. TENSOR PARA BANDA MICRO-V TENSOR- POLEA DE DIST. TENSOR- POLEA DE DIST. TENSOR- POLEA DE DIST.	HIDRAULICO POLEA TENSORA
4 CIL. 1.8 L	2000	TCKWP306A 38068 38151 T43065 T43028 T42044 T43018 T43066	KIT DE DISTRIBUCION CON B.A. TENSOR TENSOR TENSOR- POLEA DE DIST. TENSOR- POLEA DE DIST. TENSOR- POLEA DE DIST. TENSOR- POLEA DE DIST. TENSOR- POLEA DE DIST.	A.A. POLEA HIDRAULICO POLEA TENSORA
V6. 2.8 L	2000	TCKWP297 38193 T41227 T43026 T41082	KIT DE DISTRIBUCION CON B.A. TENSOR TENSOR- POLEA DE DIST. TENSOR- POLEA DE DIST. TENSOR- POLEA DE DIST.	HIDRAULICO POLEA TENSORA HIDRAULICO
4 CIL. 1.8 L	1999	TCKWP306A 38068	KIT DE DISTRIBUCION CON B.A. TENSOR	A.A.

**TSX**

V6. 3.5 L	2010	TCK329 36112 T43129 T41232 T41231	KIT DE DISTRIBUCION POLEA TENSOR- POLEA DE DIST. TENSOR- POLEA DE DIST. TENSOR- POLEA DE DIST.	
4 CIL. 2.4 L	2009	36320 39073	POLEA TENSOR	
4 CIL. 2.4 L	2006	38278	TENSOR PARA BANDA MICRO-V	

**VIGOR**

5 CIL. 2.5 L	1994	TCKWP211A	KIT DE DISTRIBUCION CON B.A.	
5 CIL. 2.5 L	1993	TCKWP211A	KIT DE DISTRIBUCION CON B.A.	
5 CIL. 2.5 L	1992	TCKWP211A	KIT DE DISTRIBUCION CON B.A.	

**AUDI**

**A3**

4 CIL. 2.0 L	2009	37013P	POLEA DECOPLADORA	
4 CIL. 2.0 L	2008	37013P 38018 T42019	POLEA DECOPLADORA TENSOR TENSOR- POLEA DE DIST.	
V6. 3.2 L	2008	36300 37013P 38450	POLEA POLEA DECOPLADORA TENSOR	
4 CIL. 2.0 L	2007	38018 37013P 38018	POLEA POLEA DECOPLADORA TENSOR	
V6. 3.2 L	2007	36300 37013P 38450	POLEA POLEA DECOPLADORA TENSOR	
4 CIL. 2.0 L	2006	37013P 38018 T42019	POLEA DECOPLADORA TENSOR TENSOR- POLEA DE DIST.	

**A4**

V6. 3.2 L	2009	38015 38423	TENSOR TENSOR	
V6. 3.2 L	2008	38015 38423	TENSOR TENSOR	
4 CIL. 2.0 L	2007	38207	TENSOR	
V6. 3.2 L	2007	38015 38423 38015	POLEA TENSOR TENSOR	
4 CIL. 1.8 L	2006	TCK306 38207 38207 T42019 T43028 T43018 T43028	KIT DE DISTRIBUCION TENSOR TENSOR PARA BANDA MICRO-V TENSOR- POLEA DE DIST. TENSOR- POLEA DE DIST. TENSOR- POLEA DE DIST. TENSOR- POLEA DE DIST.	HIDRAULICO

V6. 3.0 L	2005	T42138 T41086 T42137 T43027	TENSOR- POLEA DE DIST. TENSOR- POLEA DE DIST. TENSOR- POLEA DE DIST. TENSOR- POLEA DE DIST.	HIDRAULICO POLEA TENSORA DER.
4 CIL. 1.8 L	2004	TCKWP306A 38207 T43018 T43028 T43027 T42137 T42138 T41086	KIT DE DISTRIBUCION CON B.A. TENSOR TENSOR- POLEA DE DIST. TENSOR- POLEA DE DIST. TENSOR- POLEA DE DIST. TENSOR- POLEA DE DIST. TENSOR- POLEA DE DIST. TENSOR- POLEA DE DIST.	POLEA TENSORA IZQ HIDRAULICO
V6. 3.0 L	2004	T43018 T43028 T43027 T42137 T42138 T41086	TENSOR- POLEA DE DIST. TENSOR- POLEA DE DIST. TENSOR- POLEA DE DIST. TENSOR- POLEA DE DIST. TENSOR- POLEA DE DIST. TENSOR- POLEA DE DIST.	HIDRAULICO HIDRAULICO POLEA TENSORA IZQ POLEA TENSORA DER.
4 CIL. 1.8 L	2003	TCKWP306A 38207 T43028 T43018 T42138 T41086 T42137 T43027	KIT DE DISTRIBUCION CON B.A. TENSOR TENSOR- POLEA DE DIST. TENSOR- POLEA DE DIST. TENSOR- POLEA DE DIST. TENSOR- POLEA DE DIST. TENSOR- POLEA DE DIST. TENSOR- POLEA DE DIST.	HIDRAULICO ALTERNADOR ALTERNADOR HIDRAULICO
V6. 3.0 L	2003	T42138 T41086 T42137 T43027	TENSOR- POLEA DE DIST. TENSOR- POLEA DE DIST. TENSOR- POLEA DE DIST. TENSOR- POLEA DE DIST.	POLEA TENSORA DER. POLEA TENSORA IZQ HIDRAULICO
4 CIL. 1.8 L	2002	TCKWP306A 38151 38151 T43028 T43018 T42137 T43027 T42138 T41086	KIT DE DISTRIBUCION CON B.A. TENSOR TENSOR PARA BANDA MICRO-V TENSOR- POLEA DE DIST. TENSOR- POLEA DE DIST. TENSOR- POLEA DE DIST. TENSOR- POLEA DE DIST. TENSOR- POLEA DE DIST. TENSOR- POLEA DE DIST.	HIDRAULICO ALTERNADOR ALTERNADOR HIDRAULICO
V6. 3.0 L	2002	T42137 T43027 T42138 T41086	TENSOR- POLEA DE DIST. TENSOR- POLEA DE DIST. TENSOR- POLEA DE DIST. TENSOR- POLEA DE DIST.	POLEA TENSORA IZQ HIDRAULICO POLEA TENSORA DER.
4 CIL. 1.8 L	2001	TCKWP306A 38068 38068 38151 T43018 T43028	KIT DE DISTRIBUCION CON B.A. POLEA TENSOR TENSOR TENSOR- POLEA DE DIST. TENSOR- POLEA DE DIST.	A.A. A.A. HIDRAULICO
V6. 2.8 L	2001	TCKWP297 38193 T41227 T41082 T43026	KIT DE DISTRIBUCION CON B.A. TENSOR PARA BANDA MICRO-V TENSOR- POLEA DE DIST. TENSOR- POLEA DE DIST. TENSOR- POLEA DE DIST.	HIDRAULICO POLEA TENSORA
4 CIL. 1.8 L	2000	TCKWP306A 38068 38151 T43065 T43028 T42044 T43018 T43066	KIT DE DISTRIBUCION CON B.A. TENSOR TENSOR TENSOR- POLEA DE DIST. TENSOR- POLEA DE DIST. TENSOR- POLEA DE DIST. TENSOR- POLEA DE DIST. TENSOR- POLEA DE DIST.	A.A. POLEA HIDRAULICO POLEA TENSORA
V6. 2.8 L	2000	TCKWP297 38193 T41227 T43026 T41082	KIT DE DISTRIBUCION CON B.A. TENSOR TENSOR- POLEA DE DIST. TENSOR- POLEA DE DIST. TENSOR- POLEA DE DIST.	HIDRAULICO POLEA TENSORA HIDRAULICO
4 CIL. 1.8 L	1999	TCKWP306A 38068	KIT DE DISTRIBUCION CON B.A. TENSOR	A.A.

4 CIL. 1.8 L	1999	38151	SENSOR	
		T42044	SENSOR- POLEA DE DIST.	POLEA TENSORA
		T43065	SENSOR- POLEA DE DIST.	POLEA
		T43066	SENSOR- POLEA DE DIST.	HIDRAULICO
		T43018	SENSOR- POLEA DE DIST.	
		T43028	SENSOR- POLEA DE DIST.	HIDRAULICO
V6, 2.8 L	1999	TCKWP297	KIT DE DISTRIBUCION CON B.A.	
		38193	SENSOR	V6, 2.8 L
		T41082	SENSOR- POLEA DE DIST.	
		T41227	SENSOR- POLEA DE DIST.	POLEA TENSORA
		T43026	SENSOR- POLEA DE DIST.	HIDRAULICO
4 CIL. 1.8 L	1998	38151	SENSOR	
		38068	SENSOR	A.A.
		T43066	SENSOR- POLEA DE DIST.	HIDRAULICO
		T42044	SENSOR- POLEA DE DIST.	POLEA TENSORA
		T43065	SENSOR- POLEA DE DIST.	POLEA
V6, 2.8 L	1998	TCKWP297	KIT DE DISTRIBUCION CON B.A.	
		38193	SENSOR	V6, 2.8 L
		T41082	SENSOR- POLEA DE DIST.	
		T41227	SENSOR- POLEA DE DIST.	POLEA TENSORA
		T43073	SENSOR- POLEA DE DIST.	HIDRAULICO
4 CIL. 1.8 L	1997	T43066	SENSOR- POLEA DE DIST.	HIDRAULICO
		T43065	SENSOR- POLEA DE DIST.	POLEA
		T42044	SENSOR- POLEA DE DIST.	POLEA TENSORA

		T41227	SENSOR- POLEA DE DIST.	POLEA TENSORA
		T43026	SENSOR- POLEA DE DIST.	HIDRAULICO
V6, 2.8 L	2000	TCKWP297	KIT DE DISTRIBUCION CON B.A.	
		38193	SENSOR	
		T41227	SENSOR- POLEA DE DIST.	POLEA TENSORA
		T41082	SENSOR- POLEA DE DIST.	
		T43026	SENSOR- POLEA DE DIST.	HIDRAULICO
V6, 2.8 L	2000	TCKWP297A	KIT DE DISTRIBUCION CON B.A.	
		T43029	SENSOR- POLEA DE DIST.	HIDRAULICO
		T41097	SENSOR- POLEA DE DIST.	
V6, 2.8 L	1999	TCKWP297	KIT DE DISTRIBUCION CON B.A.	
		38193	SENSOR	
		T43026	SENSOR- POLEA DE DIST.	HIDRAULICO
		T41227	SENSOR- POLEA DE DIST.	POLEA TENSORA
		T41082	SENSOR- POLEA DE DIST.	
V6, 2.8 L	1998	TCKWP297	KIT DE DISTRIBUCION CON B.A.	
		38193	SENSOR	
		T41082	SENSOR- POLEA DE DIST.	
		T41227	SENSOR- POLEA DE DIST.	POLEA TENSORA
		T43026	SENSOR- POLEA DE DIST.	HIDRAULICO

**A6**

V6, 3.2 L	2008	38423	SENSOR	
		38015	SENSOR	
V6, 3.2 L	2007	38423	SENSOR	
		38015	SENSOR	
V6, 3.0 L	2006	38015	SENSOR	
V6, 3.2 L	2006	38015	SENSOR	
		38423	SENSOR	
V6, 3.0 L	2005	38015	SENSOR	
V6, 2.7 L	2004	T41227	SENSOR- POLEA DE DIST.	POLEA TENSORA
		T41082	SENSOR- POLEA DE DIST.	
		T43026	SENSOR- POLEA DE DIST.	HIDRAULICO
V6, 3.0 L	2004	T43027	SENSOR- POLEA DE DIST.	HIDRAULICO
		T42137	SENSOR- POLEA DE DIST.	POLEA TENSORA IZQ
		T42138	SENSOR- POLEA DE DIST.	POLEA TENSORA DER.
		T41086	SENSOR- POLEA DE DIST.	
V8, 4.2 L	2004	TCKWP297A	KIT DE DISTRIBUCION CON B.A.	
		38093	POLEA	
V6, 2.7 L	2003	T43026	SENSOR- POLEA DE DIST.	HIDRAULICO
		T41082	SENSOR- POLEA DE DIST.	
		T41227	SENSOR- POLEA DE DIST.	POLEA TENSORA
V6, 3.0 L	2003	T41086	SENSOR- POLEA DE DIST.	
		T43027	SENSOR- POLEA DE DIST.	HIDRAULICO
		T42137	SENSOR- POLEA DE DIST.	POLEA TENSORA IZQ
		T42138	SENSOR- POLEA DE DIST.	POLEA TENSORA DER.
V8, 4.2 L	2003	TCKWP297A	KIT DE DISTRIBUCION CON B.A.	
V6, 2.7 L	2002	T41227	SENSOR- POLEA DE DIST.	POLEA TENSORA
		T41082	SENSOR- POLEA DE DIST.	
		T43026	SENSOR- POLEA DE DIST.	HIDRAULICO
V6, 3.0 L	2002	T42138	SENSOR- POLEA DE DIST.	POLEA TENSORA DER.
		T42137	SENSOR- POLEA DE DIST.	POLEA TENSORA IZQ
		T41086	SENSOR- POLEA DE DIST.	
		T43027	SENSOR- POLEA DE DIST.	HIDRAULICO
V8, 4.2 L	2002	TCKWP297A	KIT DE DISTRIBUCION CON B.A.	
V6, 2.7 L	2001	T41082	SENSOR- POLEA DE DIST.	
		T43026	SENSOR- POLEA DE DIST.	HIDRAULICO
		T41227	SENSOR- POLEA DE DIST.	POLEA TENSORA
V6, 2.8 L	2001	TCKWP297	KIT DE DISTRIBUCION CON B.A.	
		38193	SENSOR	
		T43026	SENSOR- POLEA DE DIST.	HIDRAULICO
		T41082	SENSOR- POLEA DE DIST.	
		T41227	SENSOR- POLEA DE DIST.	POLEA TENSORA
V8, 4.2 L	2001	TCKWP297A	KIT DE DISTRIBUCION CON B.A.	
		T41097	SENSOR- POLEA DE DIST.	
		T43029	SENSOR- POLEA DE DIST.	HIDRAULICO
V6, 2.7 L	2000	38193	SENSOR	POLEA TENSORA
		T41082	SENSOR- POLEA DE DIST.	

**A8**

V8, 4.2 L	2008	TCKWP297A	KIT DE DISTRIBUCION CON B.A.	
V8, 4.2 L	2007	TCK297	KIT DE DISTRIBUCION	
		TCKWP297A	KIT DE DISTRIBUCION CON B.A.	
		38451	SENSOR	
		T43032	SENSOR- POLEA DE DIST.	
V8, 4.2 L	2006	TCKWP297A	KIT DE DISTRIBUCION CON B.A.	
		38093	SENSOR	
V8, 4.2 L	2005	TCKWP297A	KIT DE DISTRIBUCION CON B.A.	
		38093	SENSOR	
V8, 4.2 L	2004	TCKWP297A	KIT DE DISTRIBUCION CON B.A.	
		38093	SENSOR	
V8, 4.2 L	2003	TCKWP297A	KIT DE DISTRIBUCION CON B.A.	
		38093	SENSOR	
V8, 4.2 L	2002	TCKWP297A	KIT DE DISTRIBUCION CON B.A.	
		38093	SENSOR	
V8, 4.2 L	2001	TCKWP297A	KIT DE DISTRIBUCION CON B.A.	
		38093	SENSOR	
		T43029	SENSOR- POLEA DE DIST.	HIDRAULICO
		T41097	SENSOR- POLEA DE DIST.	
V8, 4.2 L	2000	38093	SENSOR	
		T41097	SENSOR- POLEA DE DIST.	
		T43029	SENSOR- POLEA DE DIST.	HIDRAULICO
V8, 3.7 L	1999	38093	SENSOR	
V8, 4.2 L	1999	38093	SENSOR	
V8, 3.7 L	1998	38093	SENSOR	

**A8 QUATTRO**

V8, 4.2 L	2000	38093	SENSOR	
V8, 4.2 L	1999	38093	SENSOR	

**ALLROAD QUATTRO**

V6, 2.7 L	2006	38193	SENSOR	
V6, 2.7 L	2005	TCKWP297B	KIT DE DISTRIBUCION CON B.A.	
		38193	SENSOR	
		T43026	SENSOR- POLEA DE DIST.	HIDRAULICO
		T41082	SENSOR- POLEA DE DIST.	
		T41227	SENSOR- POLEA DE DIST.	POLEA TENSORA
V6, 2.7 L	2004	TCKWP297B	KIT DE DISTRIBUCION CON B.A.	
		38193	SENSOR	
		T43026	SENSOR- POLEA DE DIST.	HIDRAULICO
		T41227	SENSOR- POLEA DE DIST.	POLEA TENSORA
		T41082	SENSOR- POLEA DE DIST.	
V6, 2.7 L	2003	TCKWP297B	KIT DE DISTRIBUCION CON B.A.	
		38193	SENSOR	
		T41082	SENSOR- POLEA DE DIST.	
		T43026	SENSOR- POLEA DE DIST.	HIDRAULICO
		T41227	SENSOR- POLEA DE DIST.	POLEA TENSORA
V6, 2.7 L	2002	TCKWP297B	KIT DE DISTRIBUCION CON B.A.	

V6, 2.7 L	2002	38193 T41082 T41227 T43026	TENSOR TENSOR- POLEA DE DIST. TENSOR- POLEA DE DIST. TENSOR- POLEA DE DIST.	POLEA TENSORA HIDRAULICO
V6, 2.7 L	2001	T41082 T43026 T41227	TENSOR- POLEA DE DIST. TENSOR- POLEA DE DIST. TENSOR- POLEA DE DIST.	HIDRAULICO POLEA TENSORA

4 CIL. 1.8 L	2000	T43025 TCKWP306 37013P 38148 38018 T43025	TENSOR- POLEA DE DIST. KIT DE DISTRIBUCION CON B.A. POLEA DECOPLADORA TENSOR TENSOR TENSOR- POLEA DE DIST.	HIDRAULICO

**CABRIOLET**

V6, 2.8 L	1998	38078	POLEA
-----------	------	-------	-------

**Q5**

V6, 3.2 L	2009	38423	TENSOR
-----------	------	-------	--------

**Q7**

V6, 3.6 L	2009	38317	TENSOR
V6, 3.6 L	2008	38317	TENSOR
V6, 3.6 L	2007	38317	TENSOR
		38317	TENSOR PARA BANDA MICRO-V

**S4**

V6, 2.7 L	2002	T43026 T41082 T41227	TENSOR- POLEA DE DIST. TENSOR- POLEA DE DIST. TENSOR- POLEA DE DIST.	HIDRAULICO POLEA TENSORA
V6, 2.7 L	2001	T41082 T43026 T41227	TENSOR- POLEA DE DIST. TENSOR- POLEA DE DIST. TENSOR- POLEA DE DIST.	HIDRAULICO POLEA TENSORA
V6, 2.7 L	2000	T43026 T41082 T41227	TENSOR- POLEA DE DIST. TENSOR- POLEA DE DIST. TENSOR- POLEA DE DIST.	HIDRAULICO POLEA TENSORA

**S4 QUATTRO**

V6, 2.7 L	2002	38193	TENSOR
V6, 2.7 L	2001	38193	TENSOR
V6, 2.7 L	2000	38193	TENSOR

**S8**

V8, 4.2 L	2001	T43029 T41097	TENSOR- POLEA DE DIST. TENSOR- POLEA DE DIST.	HIDRAULICO
-----------	------	------------------	--	------------

**TT**

4 CIL. 1.8 L	2006	38148 38018 38148 T43025	TENSOR TENSOR TENSOR PARA BANDA MICRO-V TENSOR- POLEA DE DIST.	HIDRAULICO
4 CIL. 1.8 L	2005	TCKWP306 38148 38018 T43025	KIT DE DISTRIBUCION CON B.A. TENSOR TENSOR TENSOR- POLEA DE DIST.	HIDRAULICO
4 CIL. 1.8 L	2004	TCKWP306 38018 38148 T43025	KIT DE DISTRIBUCION CON B.A. TENSOR TENSOR TENSOR- POLEA DE DIST.	HIDRAULICO
4 CIL. 1.8 L	2003	TCKWP306 37013P 37013P 38148 38018 T43025	KIT DE DISTRIBUCION CON B.A. POLEA DECOPLADORA POLEA DECOPLADORA TENSOR TENSOR TENSOR- POLEA DE DIST.	HIDRAULICO
4 CIL. 1.8 L	2002	TCKWP306 37013P 38018 38148 T43025	KIT DE DISTRIBUCION CON B.A. POLEA DECOPLADORA TENSOR TENSOR TENSOR- POLEA DE DIST.	HIDRAULICO
4 CIL. 1.8 L	2001	TCKWP306 37013P 38018 38148	KIT DE DISTRIBUCION CON B.A. POLEA DECOPLADORA TENSOR TENSOR	HIDRAULICO

**BMW**

**318I**

V6, 2.8 L	2000	38228 38201	TENSOR PARA BANDA MICRO-V TENSOR PARA BANDA MICRO-V	A.A. ALT., B.A., & D.H. C/TENSOR A
4 CIL. 1.9 L	1999	38071 38070 38223	POLEA POLEA TENSOR PARA BANDA MICRO-V	ALT. B. AGUA Y D.H. CANADA A.A. CANADA ALT. B. AGUA Y D.H. CANADA
V6, 2.8 L	1999	38224	TENSOR PARA BANDA MICRO-V	A.A.
4 CIL. 1.9 L	1998	38071 38070 38223	TENSOR TENSOR TENSOR	ALT. B. AGUA Y D.H. A.A. ALT. B. AGUA Y D.H.
4 CIL. 1.8 L	1995	38222	TENSOR PARA BANDA MICRO-V	Ait. & B.A.
4 CIL. 1.8 L	1994	38222	TENSOR PARA BANDA MICRO-V	Ait. & B.A.
4 CIL. 1.8 L	1993	36060	POLEA	POLEA LOCA Ait.
4 CIL. 1.8 L	1992	36060	POLEA	POLEA LOCA Ait.
4 CIL. 1.8 L	1991	36060	POLEA	POLEA LOCA Ait.

**318IS**

4 CIL. 1.8 L	1995	38222	TENSOR PARA BANDA MICRO-V	Ait. & B.A.
4 CIL. 1.8 L	1994	38222	TENSOR PARA BANDA MICRO-V	Ait. & B.A.
4 CIL. 1.8 L	1993	36060	POLEA	POLEA LOCA Ait.
4 CIL. 1.8 L	1992	36060	POLEA	POLEA LOCA Ait.
4 CIL. 1.8 L	1991	36060	POLEA	POLEA LOCA Ait.

**318TI**

4 CIL. 1.9 L	1999	38071 38070 38223	TENSOR TENSOR TENSOR	ALT., B.A., & D.H. A.A. ALT. B. AGUA Y D.H.
4 CIL. 1.9 L	1998	38070 38071 38223	TENSOR TENSOR TENSOR	A.A. ALT., B.A., & D.H. ALT. B. AGUA Y D.H.
4 CIL. 1.8 L	1995	38222	TENSOR PARA BANDA MICRO-V	Ait. & B.A.

**320I**

6 CIL. 2.2 L	2005	38069 38221	POLEA TENSOR PARA BANDA MICRO-V	ALT. B. AGUA Y D.H. CANADA ALT. B. AGUA Y D.H. CANADA
V6, 2.2 L	2005	38071	TENSOR	
V6, 2.2 L	2004	38071	TENSOR	

**323I**

6 CIL. 2.5 L	1999	38220	TENSOR PARA BANDA MICRO-V	A.A.
--------------	------	-------	---------------------------	------

**325**

6 CIL. 2.7 L	1988	T41083	TENSOR- POLEA DE DIST.	
6 CIL. 2.7 L	1987	T41083	TENSOR- POLEA DE DIST.	
6 CIL. 2.7 L	1986	T41083	TENSOR- POLEA DE DIST.	

**325CI**

V6, 2.5 L	2006	38384 38384	TENSOR TENSOR PARA BANDA MICRO-V	
-----------	------	----------------	-------------------------------------	--

**325E**

6 CIL. 2.7 L	1987	T41083	TENSOR- POLEA DE DIST.	
6 CIL. 2.7 L	1986	T41083	TENSOR- POLEA DE DIST.	
6 CIL. 2.7 L	1985	T41083	TENSOR- POLEA DE DIST.	

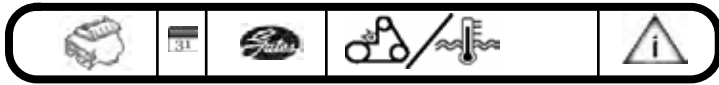

**325I**

V6, 3.0 L	2006	38384	TENSOR	
V6, 2.5 L	2005	38384	TENSOR	
6 CIL. 2.5 L	1993	T41083	TENSOR- POLEA DE DIST.	
6 CIL. 2.5 L	1992	T41083	TENSOR- POLEA DE DIST.	
6 CIL. 2.5 L	1991	T41083	TENSOR- POLEA DE DIST.	
6 CIL. 2.5 L	1990	T41083	TENSOR- POLEA DE DIST.	
6 CIL. 2.5 L	1989	T41083	TENSOR- POLEA DE DIST.	
6 CIL. 2.5 L	1988	T41083	TENSOR- POLEA DE DIST.	
6 CIL. 2.5 L	1987	T41083	TENSOR- POLEA DE DIST.	

**325IS**

6 CIL. 2.5 L	1993	T41083	TENSOR- POLEA DE DIST.	
6 CIL. 2.5 L	1992	T41083	TENSOR- POLEA DE DIST.	
6 CIL. 2.5 L	1991	T41083	TENSOR- POLEA DE DIST.	
6 CIL. 2.5 L	1990	T41083	TENSOR- POLEA DE DIST.	
6 CIL. 2.5 L	1989	T41083	TENSOR- POLEA DE DIST.	
6 CIL. 2.5 L	1988	T41083	TENSOR- POLEA DE DIST.	
6 CIL. 2.5 L	1987	T41083	TENSOR- POLEA DE DIST.	

**325IX**

6 CIL. 2.5 L	1991	T41083	TENSOR- POLEA DE DIST.	
6 CIL. 2.5 L	1990	T41083	TENSOR- POLEA DE DIST.	
6 CIL. 2.5 L	1989	T41083	TENSOR- POLEA DE DIST.	
6 CIL. 2.5 L	1988	T41083	TENSOR- POLEA DE DIST.	

**325XI**

V6, 3.0 L	2006	38384	TENSOR	
6 CIL. 2.5 L	2005	38201	TENSOR	ALT, B. AGUA Y D.H.
		38069	TENSOR	ALT, B. AGUA Y D.H.
		38071	TENSOR	ALT, B. AGUA Y D.H.
		38018	TENSOR	
		38221	TENSOR	ALT, B. AGUA Y D.H.
6 CIL. 2.5 L	2004	38201	TENSOR	ALT, B. AGUA Y D.H.
		38221	TENSOR	ALT, B. AGUA Y D.H.
		38071	TENSOR	ALT, B. AGUA Y D.H.
		38069	TENSOR	ALT, B. AGUA Y D.H.

**328I**

V6, 2.8 L	2000	38201	TENSOR	ALT., B.A., & D.H. C/TENSOR A
		38224	TENSOR	A.A.
		38071	TENSOR	ALT., B.A., & D.H.

**330CI**

6 CIL. 3.0 L	2003	38069	TENSOR	ALT, B. AGUA Y D.H.
		38201	TENSOR	ALT, B. AGUA Y D.H.
		38221	TENSOR	ALT, B. AGUA Y D.H.
		38071	TENSOR	ALT, B. AGUA Y D.H.
6 CIL. 3.0 L	2002	38201	TENSOR	ALT, B. AGUA Y D.H.
		38221	TENSOR	ALT, B. AGUA Y D.H.
		38224	TENSOR	A.A.
		38069	TENSOR	ALT, B. AGUA Y D.H.
		38071	TENSOR	ALT, B. AGUA Y D.H.
6 CIL. 3.0 L	2001	38221	TENSOR	ALT, B. AGUA Y D.H.
		38071	TENSOR	ALT, B. AGUA Y D.H.
		38201	TENSOR	ALT, B. AGUA Y D.H.
		38224	TENSOR	A.A.
		38069	TENSOR	ALT, B. AGUA Y D.H.

**330XI**

6 CIL. 3.0 L	2006	38018	TENSOR	A.A.
6 CIL. 3.0 L	2005	38018	TENSOR	
		38221	TENSOR	ALT, B. AGUA Y D.H.
		38201	TENSOR	ALT, B. AGUA Y D.H.
		38069	TENSOR	ALT, B. AGUA Y D.H.
		38071	TENSOR	ALT, B. AGUA Y D.H.
6 CIL. 3.0 L	2001	38071	TENSOR	ALT, B. AGUA Y D.H.

		38069	TENSOR	ALT, B. AGUA Y D.H.
		38224	TENSOR	A.A.
		38221	TENSOR	ALT, B. AGUA Y D.H.
		38201	TENSOR	ALT, B. AGUA Y D.H.

**525I**

6 CIL. 2.5 L	2005	38069	TENSOR	ALT, B. AGUA Y D.H.
		38201	TENSOR	ALT, B. AGUA Y D.H.
		38221	TENSOR	ALT, B. AGUA Y D.H.
		38071	TENSOR	ALT, B. AGUA Y D.H.
6 CIL. 2.5 L	2004	38201	TENSOR	ALT, B. AGUA Y D.H.
		38221	TENSOR	ALT, B. AGUA Y D.H.
		38071	TENSOR	ALT, B. AGUA Y D.H.
		38069	TENSOR	ALT, B. AGUA Y D.H.
6 CIL. 2.5 L	2003	38201	TENSOR	ALT, B. AGUA Y D.H.
		38069	TENSOR	ALT, B. AGUA Y D.H.
		38071	TENSOR	ALT, B. AGUA Y D.H.
		38221	TENSOR	ALT, B. AGUA Y D.H.
6 CIL. 2.5 L	2002	38071	TENSOR	ALT, B. AGUA Y D.H.
		38201	TENSOR	ALT, B. AGUA Y D.H.
		38221	TENSOR	ALT, B. AGUA Y D.H.
		38224	TENSOR	A.A.
		38069	TENSOR	ALT, B. AGUA Y D.H.
6 CIL. 2.5 L	2001	38201	TENSOR	ALT, B. AGUA Y D.H.
		38224	TENSOR	A.A.
		38071	TENSOR	ALT, B. AGUA Y D.H.
		38069	TENSOR	ALT, B. AGUA Y D.H.
		38221	TENSOR	ALT, B. AGUA Y D.H.
6 CIL. 2.5 L	1993	T41083	TENSOR- POLEA DE DIST.	
6 CIL. 2.5 L	1992	T41083	TENSOR- POLEA DE DIST.	
6 CIL. 2.5 L	1991	T41083	TENSOR- POLEA DE DIST.	
6 CIL. 2.5 L	1990	T41083	TENSOR- POLEA DE DIST.	
6 CIL. 2.5 L	1989	T41083	TENSOR- POLEA DE DIST.	

**528E**

6 CIL. 2.7 L	1988	T41083	TENSOR- POLEA DE DIST.	
6 CIL. 2.7 L	1987	T41083	TENSOR- POLEA DE DIST.	
6 CIL. 2.7 L	1986	T41083	TENSOR- POLEA DE DIST.	
6 CIL. 2.7 L	1985	T41083	TENSOR- POLEA DE DIST.	
6 CIL. 2.7 L	1984	T41083	TENSOR- POLEA DE DIST.	
6 CIL. 2.7 L	1983	T41083	TENSOR- POLEA DE DIST.	
6 CIL. 2.7 L	1982	T41083	TENSOR- POLEA DE DIST.	

**528I**

V6, 2.8 L	2000	38201	TENSOR	ALT., B.A., & D.H. C/TENSOR A
		38224	TENSOR	A.A.
V6, 2.8 L	1999	38201	TENSOR	ALT., B.A., & D.H. C/TENSOR A
		38224	TENSOR	A.A.
V6, 2.8 L	1998	38201	TENSOR	ALT., B.A., & D.H. C/TENSOR A

**530I**

6 CIL. 3.0 L	2002	38224	TENSOR	
		38071	TENSOR	ALT, B. AGUA Y D.H.
		38201	TENSOR	ALT, B. AGUA Y D.H.
		38221	TENSOR	ALT, B. AGUA Y D.H.
		38018	TENSOR	A.A.
		38069	TENSOR	ALT, B. AGUA Y D.H.
V8, 3.0 L	1995	38045	POLEA	POLEA LOCA Alt. (INF.)
		38045	POLEA	POLEA LOCA A.A.
		38046	POLEA	POLEA LOCA Alt. (SUP.)
V8, 3.0 L	1994	38045	POLEA	POLEA LOCA A.A.
		38045	POLEA	POLEA LOCA Alt. (INF.)
		38046	POLEA	POLEA LOCA Alt. (SUP.)

**540I**

V8, 4.4 L	2003	38066	POLEA	A.A.
		38063	POLEA	ALT, B. AGUA Y D.H.
		38218	TENSOR PARA BANDA MICRO-V	ALT, B. AGUA Y D.H.
		38219	TENSOR PARA BANDA MICRO-V	A.A.

V8, 4.4 L	2001	38063	TENSOR	ALT. B. AGUA Y D.H.
		38066	TENSOR	A.A.
		38218	TENSOR	ALT. Y B. AGUA
		38219	TENSOR	A.A.
V8, 4.4 L	2000	38063	TENSOR	ALT. B. AGUA Y D.H.
		38218	TENSOR	ALT. B. AGUA Y D.H.
		38066	TENSOR	A.A.
		38219	TENSOR	A.A.
V8, 4.4 L	1999	38218	TENSOR	ALT. B. AGUA Y D.H.
		38219	TENSOR	A.A.
		38063	TENSOR	ALT. B. AGUA Y D.H.
		38066	TENSOR	A.A.
V8, 4.4 L	1998	38218	TENSOR	ALT. B. AGUA Y D.H.
		38066	TENSOR	A.A.
		38063	TENSOR	ALT. B. AGUA Y D.H.
		38219	TENSOR	A.A.
V8, 4.4 L	1997	38045	POLEA	POLEA LOCA Alt., B.A. & D.H.
		38073	POLEA	POLEA LOCA Alt., B.A. & D.H.
		38045	POLEA	POLEA LOCA A.A.
V8, 4.0 L	1995	38045	POLEA	POLEA LOCA Alt. (INF.)
		38045	POLEA	POLEA LOCA A.A.
		38073	POLEA	POLEA LOCA Alt. (SUP.)
V8, 4.0 L	1994	38045	POLEA	POLEA LOCA A.A.
		38045	POLEA	POLEA LOCA Alt. (INF.)

V8, 4.4 L	1998	38219	TENSOR	A.A.
		38218	TENSOR	ALT. B. AGUA Y D.H.
		38066	TENSOR	A.A.
		38063	TENSOR	ALT. B. AGUA Y D.H.
		38219	TENSOR	A.A.
V8, 4.4 L	1997	38073	POLEA	POLEA LOCA Alt., B.A. & D.H.
		38045	POLEA	POLEA LOCA A.A.
V8, 4.4 L	1996	38045	POLEA	POLEA LOCA A.A.
		38073	POLEA	POLEA LOCA Alt. (SUP.)
V8, 4.0 L	1995	38073	POLEA	POLEA LOCA Alt. (SUP.)
		38045	POLEA	POLEA LOCA A.A.
V8, 4.0 L	1994	38046	POLEA	POLEA LOCA Alt. (SUP.)
		38045	POLEA	POLEA LOCA A.A.
		38045	POLEA	POLEA LOCA Alt. (INF.)
		38064	POLEA	POLEA LOCA Alt. (INF.)
V8, 4.0 L	1993	38046	POLEA	POLEA LOCA Alt. (SUP.)
		38064	POLEA	POLEA LOCA Alt. (INF.)
		38045	POLEA	POLEA LOCA Alt. (INF.)
		38045	POLEA	POLEA LOCA A.A.

**545I**

V8, 4.4 L	2005	38018	TENSOR	A.A.
-----------	------	-------	--------	------

**740I**

V8, 4.4 L	2001	38219	TENSOR	A.A.
		38063	TENSOR	ALT. B. AGUA Y D.H.
		38066	TENSOR	A.A.
V8, 4.4 L	2000	38218	TENSOR	ALT. B. AGUA Y D.H.
		38066	TENSOR	A.A.
		38063	TENSOR	ALT. B. AGUA Y D.H.
		38218	TENSOR	ALT. B. AGUA Y D.H.
V8, 4.4 L	1999	38219	TENSOR	A.A.
		38066	TENSOR	A.A.
		38063	TENSOR	ALT. B. AGUA Y D.H.
		38219	TENSOR	A.A.
V8, 4.4 L	1998	38218	TENSOR	ALT. B. AGUA Y D.H.
		38066	TENSOR	A.A.
		38063	TENSOR	ALT. B. AGUA Y D.H.
		38219	TENSOR	A.A.
V8, 4.4 L	1997	38218	TENSOR	ALT. B. AGUA Y D.H.
		38073	POLEA	POLEA LOCA Alt., B.A. & D.H.
		38045	POLEA	POLEA LOCA A.A.
V8, 4.0 L	1995	38073	POLEA	POLEA LOCA Alt. (SUP.)
		38045	POLEA	POLEA LOCA A.A.
V8, 4.0 L	1994	38045	POLEA	POLEA LOCA A.A.
		38045	POLEA	POLEA LOCA Alt. (INF.)
		38046	POLEA	POLEA LOCA Alt. (SUP.)
		38064	POLEA	POLEA LOCA Alt. (INF.)
V8, 4.0 L	1993	38045	POLEA	POLEA LOCA Alt. (INF.)
		38064	POLEA	POLEA LOCA Alt. (INF.)
		38045	POLEA	POLEA LOCA A.A.
		38046	POLEA	POLEA LOCA Alt. (SUP.)

**740IL**

V8, 4.4 L	2001	38218	TENSOR	ALT. B. AGUA Y D.H.
		38063	TENSOR	ALT. B. AGUA Y D.H.
		38219	TENSOR	A.A.
V8, 4.4 L	2000	38066	TENSOR	A.A.
		38218	TENSOR	ALT. B. AGUA Y D.H.
		38066	TENSOR	A.A.
		38063	TENSOR	ALT. B. AGUA Y D.H.
V8, 4.4 L	1999	38219	TENSOR	A.A.
		38063	TENSOR	ALT. B. AGUA Y D.H.
		38218	TENSOR	ALT. B. AGUA Y D.H.
		38066	TENSOR	A.A.

**745I**

V8, 4.4 L	2005	38063	TENSOR	ALT. B. AGUA Y D.H.
-----------	------	-------	--------	---------------------

**745LI**

V8, 4.4 L	2005	38063	TENSOR	ALT. B. AGUA Y D.H.
-----------	------	-------	--------	---------------------

**750IL**

V12, 5.4 L	2000	38062	POLEA	ALT. Y D.H.
		38061	POLEA	VENTILADOR Y A.A.
		38061	TENSOR	VENTILADOR Y A.A.
		38062	TENSOR	ALT. Y D.H.
V12, 5.4 L	1999	38061	TENSOR	VENTILADOR Y A.A.
		38062	TENSOR	ALT. Y D.H.
V12, 5.4 L	1998	38061	TENSOR	B. AGUA Y A.A.
		38062	TENSOR	ALT. Y D.H.
V12, 5.0 L	1993	38217	TENSOR PARA BANDA MICRO-V	Alt. & D.H.
		38217	TENSOR PARA BANDA MICRO-V	VENTILADOR & A.A.
V12, 5.0 L	1992	38217	TENSOR PARA BANDA MICRO-V	VENTILADOR & A.A.
		38217	TENSOR PARA BANDA MICRO-V	Alt. & D.H.
V12, 5.0 L	1991	38217	TENSOR PARA BANDA MICRO-V	Alt. & D.H.
		38217	TENSOR PARA BANDA MICRO-V	VENTILADOR & A.A.
V12, 5.0 L	1990	38217	TENSOR PARA BANDA MICRO-V	Alt. & D.H.
V12, 5.0 L	1989	38217	TENSOR PARA BANDA MICRO-V	Alt. & D.H.
V12, 5.0 L	1988	38217	TENSOR PARA BANDA MICRO-V	Alt. & D.H.

**760I**

V12, 6.0 L	2005	38063	TENSOR	ALT. B. AGUA Y D.H.
------------	------	-------	--------	---------------------

**760LI**

V12, 6.0 L	2005	38063	TENSOR	ALT. B. AGUA Y D.H.
------------	------	-------	--------	---------------------

**840CI**

V8, 4.4 L	1997	38065	POLEA	DEL TENSOR Alt., B.A. & D.H.
		38045	POLEA	POLEA LOCA A.A.
		38073	POLEA	POLEA LOCA Alt., B.A. & D.H.
		38045	POLEA	POLEA LOCA Alt., B.A. & D.H.
V8, 4.4 L	1996	38045	POLEA	POLEA LOCA A.A.
		38045	POLEA	POLEA LOCA Alt. (INF.)
		38073	POLEA	POLEA LOCA Alt. (SUP.)
V8, 4.0 L	1995	38065	POLEA	DEL TENSOR Alt., B.A. & D.H.
		38045	POLEA	POLEA LOCA Alt. (INF.)
		38045	POLEA	POLEA LOCA A.A.
		38073	POLEA	POLEA LOCA Alt. (SUP.)
V8, 4.0 L	1994	38065	POLEA	DEL TENSOR Alt., B.A. & D.H.
		38045	POLEA	POLEA LOCA Alt. (INF.)
		38045	POLEA	POLEA LOCA A.A.
		38073	POLEA	POLEA LOCA Alt. (SUP.)
		38065	POLEA	DEL TENSOR Alt., B.A. & D.H.

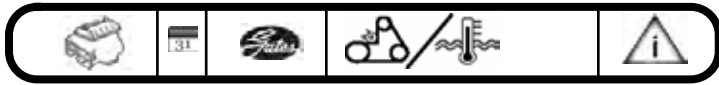

**850CI**

V12, 5.4 L	1997	38217	TENSOR PARA BANDA MICRO-V	Alt. & D.H.
		38217	TENSOR PARA BANDA MICRO-V	VENTILADOR & A.A.
V12, 5.4 L	1996	38217	TENSOR PARA BANDA MICRO-V	Alt. & D.H.
		38217	TENSOR PARA BANDA MICRO-V	VENTILADOR & A.A.
V12, 5.4 L	1995	38217	TENSOR PARA BANDA MICRO-V	VENTILADOR & A.A.
		38217	TENSOR PARA BANDA MICRO-V	Alt. & D.H.
V12, 5.0 L	1994	38217	TENSOR PARA BANDA MICRO-V	Alt. & D.H.
V12, 5.0 L	1993	38217	TENSOR PARA BANDA MICRO-V	Alt. & D.H.
		38217	TENSOR PARA BANDA MICRO-V	VENTILADOR & A.A.

V6, 3.0 L	2004	38018	TENSOR	ALT Y B.A. C/TENSOR AUTOM.
		38201	TENSOR	ALT Y B.A. C/TENSOR HIDRAL
		38221	TENSOR	A.A.
V8, 4.6 L	2002	38219	TENSOR	A.A.
		38018	TENSOR	ALT. B. AGUA Y D.H.
		38218	TENSOR	ALT. B. AGUA Y D.H.
		38063	TENSOR	A.A.
V8, 4.4 L	2000	38018	TENSOR	ALT. B. AGUA Y D.H.
		38218	TENSOR	ALT. B. AGUA Y D.H.
		38063	TENSOR	ALT. B. AGUA Y D.H.
		38219	TENSOR	A.A.

**850CSI**

V12, 5.6 L	1995	38217	TENSOR PARA BANDA MICRO-V	VENTILADOR & A.A.
		38217	TENSOR PARA BANDA MICRO-V	Alt. & D.H.
V12, 5.6 L	1994	38217	TENSOR PARA BANDA MICRO-V	Alt. & D.H.

**850I**

V12, 5.0 L	1992	38217	TENSOR PARA BANDA MICRO-V	Alt. & D.H.
		38217	TENSOR PARA BANDA MICRO-V	VENTILADOR & A.A.
V12, 5.0 L	1991	38217	TENSOR PARA BANDA MICRO-V	VENTILADOR & A.A.
		38217	TENSOR PARA BANDA MICRO-V	Alt. & D.H.

**M3**

6 CIL. 3.2 L	2002	38224	TENSOR	A.A.
		38221	TENSOR	ALT. B. AGUA Y D.H.
		38069	TENSOR	ALT. B. AGUA Y D.H.
		38071	TENSOR	ALT. B. AGUA Y D.H.
6 CIL. 3.2 L	2001	38201	TENSOR	ALT. B. AGUA Y D.H.
		38069	TENSOR	ALT. B. AGUA Y D.H.
		38071	TENSOR	ALT. B. AGUA Y D.H.
		38224	TENSOR	A.A.
		38221	TENSOR	ALT. B. AGUA Y D.H.

**M5**

V8, 5.0 L	2001	38219	TENSOR	A.A.
		38218	TENSOR	ALT. Y B. AGUA
V8, 5.0 L	2000	38218	TENSOR	ALT. B. AGUA Y D.H.
		38219	TENSOR	A.A.

**X3**

V6, 3.0 L	2008	38018	TENSOR	
V6, 3.0 L	2007	38018	TENSOR	
6 CIL. 3.0 L	2006	38071	TENSOR	ALT. B. AGUA Y D.H.
		38384	TENSOR	
		38069	TENSOR	ALT. B. AGUA Y D.H.
		38018	TENSOR	
		38221	TENSOR	ALT. B. AGUA Y D.H.
		38201	TENSOR	ALT. B. AGUA Y D.H.
6 CIL. 3.0 L	2005	38069	TENSOR	ALT. B. AGUA Y D.H.
		38221	TENSOR	ALT. B. AGUA Y D.H.
		38018	TENSOR	
		38071	TENSOR	ALT. B. AGUA Y D.H.
		38384	TENSOR	
		38201	TENSOR	ALT. B. AGUA Y D.H.

**X5**

V6, 3.0 L	2009	38018	TENSOR	
6 CIL. 3.0 L	2006	38201	TENSOR	ALT. & B.A.
		38384	TENSOR	
		38018	TENSOR	A.A.
		38221	TENSOR	ALT. & B.A. C/TENSOR HIDR.
		38071	TENSOR	ALT. C/TENSOR HIDR.
6 CIL. 3.0 L	2005	38069	TENSOR	ALT. B. AGUA Y D.H.
		38071	TENSOR	LOCA
		38384	TENSOR	
		38221	TENSOR	
		38201	TENSOR	

**Z3**

4 CIL. 1.9 L	1998	38223	TENSOR	ALT. B. AGUA Y D.H.
		38070	TENSOR	A.A.
6 CIL. 2.8 L	1998	38220	TENSOR	A.A.
		38071	TENSOR	ALT. B. AGUA Y D.H.
		38069	TENSOR	ALT. B. AGUA Y D.H.
		38201	TENSOR	ALT. B. AGUA Y D.H.
		38221	TENSOR	ALT. B. AGUA Y D.H.
6 CIL. 3.2 L	1998	38071	TENSOR	ALT. B. AGUA Y D.H.
		38070	TENSOR	ALT. B. AGUA Y D.H.
		38069	TENSOR	A.A. Y A.P.
		38221	TENSOR	ALT. B. AGUA Y D.H.

**Z4**

V6, 2.5 L	2006	38201	TENSOR	
6 CIL. 2.5 L	2005	38069	TENSOR	ALT. B. AGUA Y D.H.
		38008	TENSOR	ALT. B. AGUA Y D.H.
		38201	TENSOR	ALT. B. AGUA Y D.H.
6 CIL. 3.0 L	2005	38069	TENSOR	ALT. B. AGUA Y D.H.
		38008	TENSOR	ALT. B. AGUA Y D.H.
		38201	TENSOR	ALT. B. AGUA Y D.H.
V6, 2.5 L	2005	38201	TENSOR	
V6, 2.5 L	2004	38201	TENSOR	
V6, 3.0 L	2004	38201	TENSOR	
6 CIL. 2.5 L	2003	38201	TENSOR	ALT. B. AGUA Y D.H.
		38069	TENSOR	ALT. B. AGUA Y D.H.
		38008	TENSOR	ALT. B. AGUA Y D.H.
6 CIL. 3.0 L	2003	38069	TENSOR	ALT. B. AGUA Y D.H.
		38008	TENSOR	ALT. B. AGUA Y D.H.
		38201	TENSOR	ALT. B. AGUA Y D.H.

**BUICK**

**CENTURY**

V6, 3.3 L	1993	38128	TENSOR PARA BANDA MICRO-V	
V6, 3.3 L	1992	38128	TENSOR PARA BANDA MICRO-V	

**ELECTRA**

V6, 3.8 L	1990	38120	TENSOR PARA BANDA MICRO-V	
V6, 3.8 L	1989	38120	TENSOR PARA BANDA MICRO-V	
V6, 3.8 L	1988	38120	TENSOR PARA BANDA MICRO-V	

**ENCLAVE**

V6, 3.6 L	2010	38397	TENSOR	
-----------	------	-------	--------	--

**LACROSSE**

V6, 3.6 L	2010	38397	TENSOR	
-----------	------	-------	--------	--

**LESABRE**

V6, 3.8 L	1991	38120	TENSOR PARA BANDA MICRO-V	
V6, 3.8 L	1990	38120	TENSOR PARA BANDA MICRO-V	
V6, 3.8 L	1989	38120	TENSOR PARA BANDA MICRO-V	
V6, 3.8 L	1988	38120	TENSOR PARA BANDA MICRO-V	

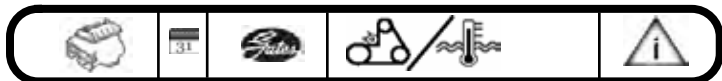

**REATA**

V6, 3.8 L	1991	38120	TENSOR PARA BANDA MICRO-V	
V6, 3.8 L	1990	38120	TENSOR PARA BANDA MICRO-V	
V6, 3.8 L	1989	38120	TENSOR PARA BANDA MICRO-V	
V6, 3.8 L	1988	38120	TENSOR PARA BANDA MICRO-V	

**REGAL**

V6, 3.8 L	1991	38120	TENSOR PARA BANDA MICRO-V	
V6, 3.8 L	1990	38120	TENSOR PARA BANDA MICRO-V	

**RIVIERA**

V6, 3.8 L	1991	38120	TENSOR PARA BANDA MICRO-V	
V6, 3.8 L	1990	38120	TENSOR PARA BANDA MICRO-V	
V6, 3.8 L	1989	38120	TENSOR PARA BANDA MICRO-V	
V6, 3.8 L	1988	38120	TENSOR PARA BANDA MICRO-V	

**SKYHAWK**

V6, 3.3 L	1993	38128	TENSOR PARA BANDA MICRO-V	
V6, 3.3 L	1992	38128	TENSOR PARA BANDA MICRO-V	
4 CIL. 2.0 L	1988	38199	TENSOR PARA BANDA MICRO-V	SERP.
4 CIL. 2.0 L	1987	38199	TENSOR PARA BANDA MICRO-V	SERP.

**CADILLAC**

**ALLANTE**

V8, 4.5 L	1992	38184	TENSOR PARA BANDA MICRO-V	
V8, 4.5 L	1991	38184	TENSOR PARA BANDA MICRO-V	
V8, 4.5 L	1990	38184	TENSOR PARA BANDA MICRO-V	
V8, 4.5 L	1989	38183	TENSOR PARA BANDA MICRO-V	
V8, 4.1 L	1988	38183	TENSOR PARA BANDA MICRO-V	
V8, 4.1 L	1987	38183	TENSOR PARA BANDA MICRO-V	

**CATERA**

V6, 3.0 L	2001	TCK285A	KIT DE DISTRIBUCION	
		38009	POLEA	
		38009	TENSOR	
		38179	TENSOR	
		38179	TENSOR PARA BANDA MICRO-V	
		T42086	TENSOR- POLEA DE DIST.	POLEA TENSORA
V6, 3.0 L	2000	TCK285A	KIT DE DISTRIBUCION	
		38179	TENSOR	
		38009	TENSOR	
		T42086	TENSOR- POLEA DE DIST.	POLEA TENSORA
V6, 3.0 L	1999	TCK285A	KIT DE DISTRIBUCION	
		TCK285	KIT DE DISTRIBUCION	
		38179	TENSOR	
		38009	TENSOR	
		T42086	TENSOR- POLEA DE DIST.	POLEA TENSORA
		T42086	TENSOR- POLEA DE DIST.	POLEA TENSORA
V6, 3.0 L	1998	TCK285	KIT DE DISTRIBUCION	
		38009	TENSOR	
		38179	TENSOR	
		T42086	TENSOR- POLEA DE DIST.	POLEA TENSORA
V6, 3.0 L	1997	T42086	TENSOR- POLEA DE DIST.	POLEA TENSORA

**CTS**

V6, 3.6 L	2007	38418	TENSOR	B.A.
		38419	TENSOR	A.A.
		38419	TENSOR PARA BANDA MICRO-V	A.A.
		38418	TENSOR PARA BANDA MICRO-V	B.A.
V8, 5.7 L	2005	38328	TENSOR PARA BANDA MICRO-V	SERPENTIN
V6, 3.2 L	2004	38009	TENSOR	
		38179	TENSOR	
		T41243	TENSOR- POLEA DE DIST.	

2003	38009	TENSOR	
	38179	TENSOR	
	T41243	TENSOR- POLEA DE DIST.	

**DEVILLE**

V8, 4.6 L	2005	38006	POLEA	SERPENTIN
		38025	POLEA	P/BA
		38041	POLEA	
		38006	TENSOR	SERPENTIN
		38041	TENSOR	
		38025	TENSOR	P/BA
		38153	TENSOR	SERPENTIN
		38197	TENSOR	P/BA
		38197	TENSOR PARA BANDA MICRO-V	P/BA
		38153	TENSOR PARA BANDA MICRO-V	SERPENTIN
V8, 4.6 L	2004	38041	TENSOR	
		38197	TENSOR	B.A.
		38025	TENSOR	B.A.
		38153	TENSOR	SERPENTIN
		38006	TENSOR	SERPENTIN
V8, 4.6 L	2003	38006	TENSOR	SERPENTIN
		38041	TENSOR	
		38025	TENSOR	B.A.
		38153	TENSOR	SERPENTIN
		38197	TENSOR	B. AGUA
V8, 4.6 L	2002	38025	TENSOR	B.A.
		38153	TENSOR	SERPENTIN
		38041	TENSOR	
		38006	TENSOR	SERPENTIN
		38197	TENSOR	B. AGUA
V8, 4.6 L	2001	38025	TENSOR	
		38041	TENSOR	
		38006	TENSOR	SERPENTIN
		38153	TENSOR	
		38197	TENSOR	B. AGUA
V8, 4.6 L	2000	38153	TENSOR	
		38025	TENSOR	
		38197	TENSOR	B. AGUA
		38041	TENSOR	
		38006	TENSOR	SERPENTIN
V8, 4.6 L	1999	38153	TENSOR	
		38041	TENSOR	
		38006	TENSOR	SERPENTIN
		38197	TENSOR	B. AGUA
		38025	TENSOR	
V8, 4.6 L	1998	38153	TENSOR	ACCESORIO
		38006	TENSOR	SERPENTIN
		38041	TENSOR	
		38197	TENSOR	B. AGUA
		38025	TENSOR	B. AGUA
V8, 4.9 L	1995	38184	TENSOR PARA BANDA MICRO-V	
V8, 4.9 L	1994	38007	POLEA	
		38007	TENSOR	
		38184	TENSOR PARA BANDA MICRO-V	
V8, 4.9 L	1993	38020	POLEA	
		38007	TENSOR	
		38020	TENSOR	
		38184	TENSOR PARA BANDA MICRO-V	
V8, 4.9 L	1992	38184	TENSOR PARA BANDA MICRO-V	
V8, 4.9 L	1991	38184	TENSOR PARA BANDA MICRO-V	
V8, 4.5 L	1990	38184	TENSOR PARA BANDA MICRO-V	
V8, 4.5 L	1989	38183	TENSOR PARA BANDA MICRO-V	
V8, 4.5 L	1988	38183	TENSOR PARA BANDA MICRO-V	
V8, 4.1 L	1987	38183	TENSOR PARA BANDA MICRO-V	
V8, 4.1 L	1986	38183	TENSOR PARA BANDA MICRO-V	
V8, 4.1 L	1985	38183	TENSOR PARA BANDA MICRO-V	

**DTS**

V8, 4.6 L	2007	38197	TENSOR	B. AGUA
		38006	TENSOR	SERPENTIN
		38041	TENSOR	SERPENTIN



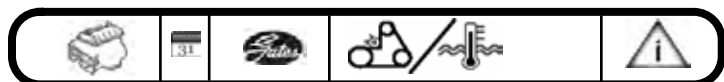

V8, 4.6 L	2007	38025	TENSOR	B. AGUA
		38153	TENSOR	ACCESORIO
V8, 4.6 L	2006	38041	TENSOR	
		38153	TENSOR	ACCESORIO
		38025	TENSOR	B. AGUA
		38006	TENSOR	SERPENTIN
		38197	TENSOR	B. AGUA



V8, 6.2 L	2007	38158	TENSOR	SERPENTIN
		36169	POLEA	SERP. A.A.
		36169	POLEA	SERP. A.A.
		38158	TENSOR	SERPENTIN
		38159	TENSOR	A.A.
		38009	TENSOR	SERPENTIN
		38001	TENSOR	SERPENTIN
V8, 6.0 L	2006	38009	TENSOR	SERPENTIN
		38159	TENSOR	A.A.
		38158	TENSOR	SERPENTIN
		38001	TENSOR	SERPENTIN
V8, 5.3 L	2005	38159	TENSOR PARA BANDA MICRO-V	A.A.
		38158	TENSOR PARA BANDA MICRO-V	SERPENTIN
V8, 6.0 L	2005	38158	TENSOR	
		38159	TENSOR	
		38009	TENSOR	SERPENTIN
		38001	TENSOR	SERPENTIN
V8, 5.3 L	2004	38009	TENSOR	SERPENTIN
		38159	TENSOR	A.A.
		38158	TENSOR	SERPENTIN
		38001	TENSOR	SERPENTIN
V8, 6.0 L	2004	38158	TENSOR	SERPENTIN
		38159	TENSOR	A.A.
		38009	TENSOR	SERPENTIN
		38001	TENSOR	SERPENTIN
V8, 5.3 L	2003	38158	TENSOR	SERPENTIN
		38001	TENSOR	SERPENTIN
		38159	TENSOR	A.A.
		38009	TENSOR	SERPENTIN
V8, 6.0 L	2003	38001	TENSOR	SERPENTIN
		38159	TENSOR	A.A.
		38158	TENSOR	SERPENTIN
		38009	TENSOR	SERPENTIN
V8, 5.3 L	2002	38001	TENSOR	SERPENTIN
		38159	TENSOR	
		38158	TENSOR	
		38009	TENSOR	SERPENTIN
V8, 6.0 L	2002	38001	TENSOR	SERPENTIN
		38159	TENSOR	
		38158	TENSOR	
		38009	TENSOR	SERPENTIN
V8, 5.7 L	2000	38008	TENSOR	SERPENTIN
		38001	TENSOR	
		38103	TENSOR	
		38103	TENSOR PARA BANDA MICRO-V	
V8, 5.7 L	1999	38001	TENSOR	
		38008	TENSOR	
		38103	TENSOR	

**ELDORADO**

V8, 4.6 L	2002	38025	TENSOR	B.A.
		38006	TENSOR	SERPENTIN
		38153	TENSOR	
		38041	TENSOR	
		38197	TENSOR	B. AGUA
V8, 4.6 L	2001	38025	TENSOR	
		38197	TENSOR	B. AGUA
		38153	TENSOR	
		38006	TENSOR	
		38041	TENSOR	
V8, 4.6 L	2000	38025	TENSOR	B. AGUA
		38197	TENSOR	
		38041	TENSOR	
		38006	TENSOR	
		38153	TENSOR	
V8, 4.6 L	1999	38197	TENSOR	B. AGUA
		38025	TENSOR	
		38006	TENSOR	
		38041	TENSOR	
		38153	TENSOR	
V8, 4.6 L	1998	38153	TENSOR	ACCESORIO
		38006	TENSOR	
		38197	TENSOR	B. AGUA
		38025	TENSOR	
		38041	TENSOR	
V8, 4.6 L	1997	38153	TENSOR	
		38006	TENSOR	
		38025	TENSOR	
		38001	TENSOR	
V8, 4.6 L	1996	38025	TENSOR	
		38006	TENSOR	
		38153	TENSOR	
		38001	TENSOR	
V8, 4.6 L	1995	38006	TENSOR	
		38153	TENSOR	
		38001	TENSOR	
		38025	TENSOR	
V8, 4.6 L	1994	38153	TENSOR	
		38001	TENSOR	
		38006	TENSOR	
V8, 4.9 L	1993	38184	TENSOR PARA BANDA MICRO-V	
V8, 4.9 L	1992	38184	TENSOR PARA BANDA MICRO-V	
V8, 4.9 L	1991	38184	TENSOR PARA BANDA MICRO-V	
V8, 4.5 L	1990	38184	TENSOR PARA BANDA MICRO-V	
V8, 4.5 L	1989	38183	TENSOR PARA BANDA MICRO-V	
V8, 4.5 L	1988	38183	TENSOR PARA BANDA MICRO-V	
V8, 4.1 L	1987	38183	TENSOR PARA BANDA MICRO-V	
V8, 4.1 L	1986	38183	TENSOR PARA BANDA MICRO-V	

**FLEETWOOD**

V8, 4.9 L	1992	38184	TENSOR PARA BANDA MICRO-V	
V8, 4.9 L	1991	38184	TENSOR PARA BANDA MICRO-V	
V8, 4.5 L	1990	38184	TENSOR PARA BANDA MICRO-V	
V8, 4.5 L	1989	38183	TENSOR PARA BANDA MICRO-V	
V8, 4.5 L	1988	38183	TENSOR PARA BANDA MICRO-V	
V8, 4.1 L	1987	38183	TENSOR PARA BANDA MICRO-V	
V8, 4.1 L	1986	38183	TENSOR PARA BANDA MICRO-V	
V8, 4.1 L	1985	38183	TENSOR PARA BANDA MICRO-V	

**ESCALADE**

V8, 6.2 L	2010	91030	HERRAMIENTA INST. STRECH FIT	
		36299	POLEA	
		38009	TENSOR	SERPENTIN
		39083	TENSOR	SERPENTIN
V8, 6.2 L	2009	91030	HERRAMIENTA INST. STRECH FIT	
		36299	POLEA	
		38009	TENSOR	SERPENTIN
		39083	TENSOR	SERPENTIN
V8, 6.2 L	2008	36169	POLEA	A.A.
		36299	POLEA	
		38159	TENSOR	A.A.
		38009	TENSOR	SERPENTIN

**REGAL**

V6, 3.8 L	1996	38152	TENSOR PARA BANDA MICRO-V	
V6, 3.8 L	1995	38027	POLEA	
		38126	TENSOR PARA BANDA MICRO-V	

**SEVILLE**

V8, 4.6 L	2004	38153	TENSOR	SERPENTIN
		38041	TENSOR	
		38197	TENSOR	B.A.
		38006	TENSOR	SERPENTIN
		38025	TENSOR	B.A.

V8, 4.6 L	2003	38197	TENSOR	B. AGUA
		38006	TENSOR	SERPENTIN
		38153	TENSOR	SERPENTIN
		38041	TENSOR	
		38025	TENSOR	B.A.
V8, 4.6 L	2002	38153	TENSOR	SERPENTIN
		38041	TENSOR	
		38006	TENSOR	SERPENTIN
		38197	TENSOR	B. AGUA
		38025	TENSOR	B.A.
V8, 4.6 L	2001	38197	TENSOR	B. AGUA
		38153	TENSOR	
		38025	TENSOR	
		38006	TENSOR	
		38041	TENSOR	
V8, 4.6 L	2000	38006	TENSOR	
		38197	TENSOR	B. AGUA
		38041	TENSOR	
		38025	TENSOR	
		38153	TENSOR	
V8, 4.6 L	1999	38041	TENSOR	
		38197	TENSOR	B. AGUA
		38006	TENSOR	
		38153	TENSOR	
		38025	TENSOR	
V8, 4.6 L	1998	38006	TENSOR	
		38041	TENSOR	
		38197	TENSOR	B. AGUA
		38153	TENSOR	ACCESORIO
		38025	TENSOR	
V8, 4.6 L	1997	38025	TENSOR	
		38006	TENSOR	
		38001	TENSOR	
V8, 4.6 L	1996	38025	TENSOR	
		38006	TENSOR	
		38001	TENSOR	
V8, 4.6 L	1995	38001	TENSOR	
		38006	TENSOR	
		38025	TENSOR	
V8, 4.6 L	1994	38006	TENSOR	
		38001	TENSOR	
V8, 4.9 L	1993	38184	TENSOR PARA BANDA MICRO-V	
V8, 4.9 L	1992	38184	TENSOR PARA BANDA MICRO-V	
V8, 4.9 L	1991	38184	TENSOR PARA BANDA MICRO-V	
V8, 4.5 L	1990	38184	TENSOR PARA BANDA MICRO-V	
V8, 4.5 L	1989	38183	TENSOR PARA BANDA MICRO-V	
V8, 4.5 L	1988	38183	TENSOR PARA BANDA MICRO-V	
V8, 4.1 L	1987	38183	TENSOR PARA BANDA MICRO-V	
V8, 4.1 L	1986	38183	TENSOR PARA BANDA MICRO-V	

4 CIL. 2.0 L	2005	TPG-14002	TENSOR ARBOL DE LEVAS	
		TCK1022M	KIT DE DISTRIBUCION	
		TCK1022M	KIT DE DISTRIBUCION	
		TPG-14001	TENSOR ARBOL DE LEVAS	
4 CIL. 2.4 L	2005	TCK305M	KIT DE DISTRIBUCION	
		TCK305M	KIT DE DISTRIBUCION	
		TPG-14002	TENSOR ARBOL DE LEVAS	
4 CIL. 1.8 L	2004	TPG-14004	TENSOR ARBOL DE LEVAS	
		TMV-14001	TENSOR MICRO-V	
4 CIL. 2.0 L	2004	TCK1022M	KIT DE DISTRIBUCION	
		TCK1022M	KIT DE DISTRIBUCION	
		TPG-14001	TENSOR ARBOL DE LEVAS	
4 CIL. 2.4 L	2004	TCK305M	KIT DE DISTRIBUCION	
		TCK305M	KIT DE DISTRIBUCION	
		TPG-14002	TENSOR ARBOL DE LEVAS	
4 CIL. 1.8 L	2003	TCK1094	KIT DE DISTRIBUCION	
		TPG-14004	TENSOR ARBOL DE LEVAS	
		TMV-14001	TENSOR MICRO-V	
4 CIL. 1.8 L	2002	TCK1094	KIT DE DISTRIBUCION	
		TPG-14004	TENSOR ARBOL DE LEVAS	
		TMV-14001	TENSOR MICRO-V	
4 CIL. 1.8 L	2001	TCK1094	KIT DE DISTRIBUCION	
		TPG-14004	TENSOR ARBOL DE LEVAS	
		TMV-14001	TENSOR MICRO-V	
4 CIL. 1.8 L	2000	TCK1094	KIT DE DISTRIBUCION	
		TPG-14004	TENSOR ARBOL DE LEVAS	
		TMV-14001	TENSOR MICRO-V	

**ASTRO**

V6, 4.3 L	1995	38107	TENSOR PARA BANDA MICRO-V	
		38106	TENSOR PARA BANDA MICRO-V	
4 CIL. 2.5 L	1990	38144	TENSOR PARA BANDA MICRO-V	
4 CIL. 2.5 L	1989	38034	POLEA	
V6, 4.3 L	1989	38017	POLEA	
		38108	TENSOR PARA BANDA MICRO-V	
		38135	TENSOR PARA BANDA MICRO-V	

**AVALANCHE**

V8, 5.3 L	2010	91030	HERRAMIENTA INST. STRECH FIT	
		36299	POLEA	
		38009	TENSOR	SERPENTIN
		39083	TENSOR	SERPENTIN
V8, 5.3 L	2009	91030	HERRAMIENTA INST. STRECH FIT	
		36299	POLEA	
		38009	TENSOR	SERPENTIN
		39083	TENSOR	SERPENTIN
V8, 5.3 L	2008	36169	POLEA	A.A.
		36299	POLEA	
		38158	TENSOR	SERPENTIN
		38159	TENSOR	A.A.
		38009	TENSOR	SERPENTIN
V8, 5.3 L	2007	36169	POLEA	SERP. A.A.
		38158	TENSOR	SERPENTIN
		38159	TENSOR	A.A.
		38001	TENSOR	SERPENTIN
		38009	TENSOR	SERPENTIN
V8, 5.3 L	2006	38159	TENSOR	A.A.
		38158	TENSOR	SERPENTIN
		38001	TENSOR	SERPENTIN
		38009	TENSOR	SERPENTIN
V8, 8.1 L	2006	38259	TENSOR PARA BANDA MICRO-V	A.A.
		38260	TENSOR PARA BANDA MICRO-V	SERPENTIN
V8, 5.3 L	2005	38009	TENSOR	
		38001	TENSOR	LOCA
		38159	TENSOR	
V8, 5.3 L	2004	38158	TENSOR	SERPENTIN
		38009	TENSOR	SERPENTIN
		38158	TENSOR	SERPENTIN
		38001	TENSOR	SERPENTIN
		38159	TENSOR	A.A.
V8, 5.3 L	2003	38159	TENSOR	A.A.

**SIXTY SPECIAL**

V8, 4.9 L	1993	38184	TENSOR PARA BANDA MICRO-V	
-----------	------	-------	---------------------------	--

**SRX**

V8, 4.6 L	2004	38006	TENSOR	ALTERNADOR
-----------	------	-------	--------	------------

**CHEVROLET**

**ASTRA**

4 CIL. 2.0 L	2008	38200	TENSOR	
		38200	TENSOR PARA BANDA MICRO-V	
4 CIL. 2.0 L	2007	38200	TENSOR	
4 CIL. 2.0 L	2006	TCK1022M	KIT DE DISTRIBUCION	
		TPG-14001	TENSOR ARBOL DE LEVAS	
		TPG-14001	TENSOR ARBOL DE LEVAS	
4 CIL. 2.4 L	2006	TCK305M	KIT DE DISTRIBUCION	
		TCK305M	KIT DE DISTRIBUCION	
		TPG-14002	TENSOR ARBOL DE LEVAS	

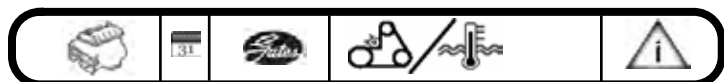

V8, 5.3 L	2003	38158	TENSOR	SERPENTIN
		38009	TENSOR	
		38001	TENSOR	
V8, 5.3 L	2002	38159	TENSOR	A.A.
		38158	TENSOR	SERPENTIN
		38001	TENSOR	SERPENTIN
		38009	TENSOR	SERPENTIN
V8, 8.1 L	2002	38009	TENSOR	SERPENTIN
		38001	TENSOR	SERPENTIN
		38259	TENSOR	A.A.
		38260	TENSOR	SERPENTIN



**BLAZER COMPACT**

V6, 2.8 L	1989	38130	TENSOR PARA BANDA MICRO-V
-----------	------	-------	---------------------------

**BLAZER FULL SIZE**

V8, 6.5 L Diesel	1994	38267	TENSOR PARA BANDA MICRO-V
------------------	------	-------	---------------------------

**C & K SERIES PICKUP**

V8, 6.5 L	2002	38006	TENSOR	
		38118	TENSOR	
		38020	TENSOR	C/Doble Alt 100A.
		38118	TENSOR PARA BANDA MICRO-V	
V8, 8.1 L	2002	38008	TENSOR	CON CANALES
		38001	TENSOR	
		38006	TENSOR	
		38258	TENSOR	
		38258	TENSOR PARA BANDA MICRO-V	
V8, 6.5 L	2001	38020	TENSOR	C/Doble Alt 100A.
		38006	TENSOR	
		38118	TENSOR	
V8, 8.1 L	2001	38006	TENSOR	
		38001	TENSOR	
		38258	TENSOR	
		38008	TENSOR	CON CANALES
V8, 5.7 L	2000	38103	TENSOR	
		38008	TENSOR	
		38001	TENSOR	LISO
		38008	TENSOR	
V8, 6.5 L	2000	38118	TENSOR	
		38006	TENSOR	
		38020	TENSOR	C/Doble Alt.
V8, 7.4 L	2000	38103	TENSOR	SERPENTIN
		38001	TENSOR	
		38008	TENSOR	CON CANALES
V8, 5.0 L	1999	38001	TENSOR	LISO
		38008	TENSOR	CON CANALES
		38103	TENSOR	
V8, 5.7 L	1999	38008	TENSOR	CON CANALES
		38001	TENSOR	LISO
		38008	TENSOR	
		38103	TENSOR	
V8, 6.5 L	1999	38020	TENSOR	C/Doble Alt.
		38118	TENSOR	
		38006	TENSOR	
V8, 7.4 L	1999	38008	TENSOR	CON CANALES
		38103	TENSOR	SERPENTIN
		38001	TENSOR	LISO
V6, 4.3 L	1998	38008	TENSOR	CON CANALES
		38103	TENSOR	
V8, 5.0 L	1998	38008	TENSOR	LISO
		38103	TENSOR	CON CANALES
V8, 5.7 L	1998	38008	TENSOR	LISO
		38103	TENSOR	
		38001	TENSOR	LISO
		38008	TENSOR	
		38103	TENSOR	CON CANALES
V6, 4.3 L	1997	38001	TENSOR	LISO
		38008	TENSOR	
		38103	TENSOR	
V8, 5.0 L	1997	38001	TENSOR	LISO
		38103	TENSOR	
		38008	TENSOR	
V8, 5.7 L	1997	38008	TENSOR	CON CANALES
		38103	TENSOR	CON CANALES
		38001	TENSOR	
		38008	TENSOR	
		38103	TENSOR	
V6, 4.3 L	1997	38001	TENSOR	LISO
		38008	TENSOR	CON CANALES
		38103	TENSOR	
V8, 5.0 L	1997	38001	TENSOR	LISO
		38103	TENSOR	
		38008	TENSOR	
V8, 5.7 L	1997	38008	TENSOR	CON CANALES
		38103	TENSOR	CON CANALES
		38001	TENSOR	
		38008	TENSOR	
		38103	TENSOR	

**AVEO**

4 CIL. 1.6 L	2009	TCK335	KIT DE DISTRIBUCION	
		38024	TENSOR	SIN A.A.
		38015	TENSOR	
		38376	TENSOR	
		T42170	TENSOR- POLEA DE DIST.	
		T43039	TENSOR- POLEA DE DIST.	
4 CIL. 1.6 L	2008	38024	POLEA	SIN A.A.
		38376	TENSOR	
		38015	TENSOR	
		38024	TENSOR	SIN A.A.
		38376	TENSOR PARA BANDA MICRO-V	
		T43039	TENSOR- POLEA DE DIST.	
		T42170	TENSOR- POLEA DE DIST.	
		T43039	TENSOR- POLEA DE DIST.	

**BLAZER**

V6, 4.3 L	2005	38008	TENSOR	RANURADA S/AA
		38001	TENSOR	LISA
		38103	TENSOR	
V6, 4.3 L	2004	38001	TENSOR	LISA
		38008	TENSOR	RANURADA; S/AA
		38103	TENSOR	
V6, 4.3 L	2003	38001	TENSOR	LISA
		38103	TENSOR	
		38008	TENSOR	
V6, 4.3 L	2002	38103	TENSOR	
		38001	TENSOR	
		38008	TENSOR	
V6, 4.3 L	2001	38008	TENSOR	
		38103	TENSOR	
		38001	TENSOR	
V6, 4.3 L	2000	38008	TENSOR	
		38001	TENSOR	
		38103	TENSOR	
V6, 4.3 L	1999	38001	TENSOR	
		38103	TENSOR	S/AA
		38008	TENSOR	S/AA
V6, 4.3 L	1998	38008	TENSOR	S/AA
		38001	TENSOR	
		38103	TENSOR	S/AA
V6, 4.3 L	1997	38001	TENSOR	
		38008	TENSOR	S/AA
		38103	TENSOR	S/AA
V6, 4.3 L	1996	38103	TENSOR	S/AA
		38001	TENSOR	
		38008	TENSOR	S/AA
V6, 4.3 L	1995	38024	TENSOR	S/AA
		38001	TENSOR	C/AA
		38108	TENSOR	C/AA
		38006	TENSOR	C/AA
V6, 4.3 L	1994	38024	TENSOR	S/AA
		38006	TENSOR	C/AA
		38001	TENSOR	S/AA
		38108	TENSOR	S/AA
V6, 4.3 L	1993	38024	TENSOR	S/AA
		38006	TENSOR	C/AA
		38108	TENSOR	S/AA
		38001	TENSOR	S/AA

V8, 5.7 L	1997	38001	TENSOR	LISO
V6, 4.3 L	1996	38001	TENSOR	LISO
		38103	TENSOR	
		38008	TENSOR	CON CANALES
V8, 5.7 L	1996	38008	TENSOR	CON CANALES
		38103	TENSOR	
		38008	TENSOR	
		38008	TENSOR	
		38001	TENSOR	LISO
V6, 4.3 L	1995	38108	TENSOR	
		38001	TENSOR	
		38006	TENSOR	
		38024	TENSOR	
V8, 5.7 L	1995	38024	TENSOR	
		38108	TENSOR	
		38006	TENSOR	C/AA
		38001	TENSOR	C/AA
V8, 6.5 L Diesel	1995	38267	TENSOR PARA BANDA MICRO-V	
V8, 7.4 L	1995	38019	POLEA	
V8, 5.7 L	1994	38108	TENSOR	
		38001	TENSOR	C/AA
		38024	TENSOR	
		38006	TENSOR	
V8, 6.5 L Diesel	1994	38267	TENSOR PARA BANDA MICRO-V	
V8, 5.7 L	1993	38108	TENSOR	
		38006	TENSOR	
		38001	TENSOR	C/AA
		38024	TENSOR	
V8, 6.2 L Diesel	1993	38267	TENSOR PARA BANDA MICRO-V	
V8, 6.5 L Diesel	1993	38267	TENSOR PARA BANDA MICRO-V	
V8, 7.4 L	1993	38143	TENSOR PARA BANDA MICRO-V	
V8, 6.2 L Diesel	1992	38267	TENSOR PARA BANDA MICRO-V	
V8, 6.5 L Diesel	1992	38267	TENSOR PARA BANDA MICRO-V	
V8, 6.2 L Diesel	1991	38267	TENSOR PARA BANDA MICRO-V	
V8, 6.2 L Diesel	1990	38267	TENSOR PARA BANDA MICRO-V	
V8, 6.2 L Diesel	1989	38267	TENSOR PARA BANDA MICRO-V	
V8, 6.2 L Diesel	1988	38267	TENSOR PARA BANDA MICRO-V	

V8, 5.7 L	1994	38108	TENSOR	S/AA
		38024	TENSOR	S/AA
		38006	TENSOR	C/AA
		38001	TENSOR	S/AA
		38108	TENSOR	S/AA
V8, 5.7 L	1993	38024	TENSOR	S/AA
		38001	TENSOR	S/AA
		38108	TENSOR	S/AA
		38006	TENSOR	C/AA

**C-30**

V8, 5.7 L	1993	38001	POLEA	C/AA
		38024	POLEA LOCA	S/AA
		38006	POLEA LOCA	C/AA
		38108	TENSOR PARA BANDA MICRO-V	C/AA
V8, 5.7 L	1992	38001	POLEA	C/AA
		38006	POLEA LOCA	C/AA
		38024	POLEA LOCA	S/AA
		38108	TENSOR PARA BANDA MICRO-V	C/AA
V8, 5.7 L	1991	38001	POLEA	C/AA
		38006	POLEA LOCA	C/AA
		38024	POLEA LOCA	S/AA
		38108	TENSOR PARA BANDA MICRO-V	C/AA
V8, 5.7 L	1990	38001	POLEA	C/AA
		38006	POLEA LOCA	C/AA
		38024	POLEA LOCA	S/AA
		38108	TENSOR PARA BANDA MICRO-V	C/AA

**C-35**

V8, 5.7 L	1993	38006	TENSOR	C/AA
		38024	TENSOR	S/AA
		38108	TENSOR	S/AA
		38001	TENSOR	S/AA

**C-3500**

V8, 5.7 L	2000	38103	TENSOR	
		38001	TENSOR	
		38008	TENSOR	S/AA
V8, 5.7 L	1999	38103	TENSOR	
		38008	TENSOR	S/AA
		38001	TENSOR	
V8, 5.7 L	1998	38008	TENSOR	S/AA
		38103	TENSOR	
V8, 5.7 L	1997	38103	TENSOR	
		38001	TENSOR	
		38008	TENSOR	S/AA
V8, 5.7 L	1996	38008	TENSOR	S/AA
		38103	TENSOR	
		38001	TENSOR	
V8, 5.7 L	1995	38001	TENSOR	S/AA
		38108	TENSOR	S/AA
		38024	TENSOR	S/AA
		38006	TENSOR	C/AA
V8, 5.7 L	1994	38006	TENSOR	C/AA
		38108	TENSOR	S/AA
		38001	TENSOR	S/AA
		38024	TENSOR	S/AA

**C & K SERIES PICKUP C-30**

4 CIL. 1.6 L	2003	T36038	TENSOR- POLEA DE DIST.	
--------------	------	--------	------------------------	--

**C-20**

V8, 5.7 L	1991	38001	POLEA	S/AA
		38024	POLEA LOCA	S/AA
		38006	POLEA LOCA	
		38108	TENSOR PARA BANDA MICRO-V	A.A.
V8, 5.7 L	1990	38001	POLEA	S/AA
		38006	POLEA LOCA	
		38024	POLEA LOCA	S/AA
		38108	TENSOR PARA BANDA MICRO-V	A.A.

**C-2500**

V8, 5.7 L	2000	38103	TENSOR	
		38008	TENSOR	S/AA
		38001	TENSOR	
V8, 5.7 L	1999	38001	TENSOR	
		38103	TENSOR	
		38008	TENSOR	S/AA
V8, 5.7 L	1998	38001	TENSOR	
		38103	TENSOR	
		38008	TENSOR	S/AA
V8, 5.7 L	1997	38103	TENSOR	
		38008	TENSOR	S/AA
		38001	TENSOR	
V8, 5.7 L	1996	38103	TENSOR	
		38008	TENSOR	S/AA
		38001	TENSOR	
V8, 5.7 L	1995	38001	TENSOR	S/AA
		38024	TENSOR	S/AA
		38006	TENSOR	C/AA

**CAMARO**

V6, 3.8 L	2002	38289	TENSOR PARA BANDA MICRO-V	
V8, 5.7 L	2002	38196	TENSOR PARA BANDA MICRO-V	A.A.
		38195	TENSOR PARA BANDA MICRO-V	SERPENTIN
V6, 3.4 L	1995	38145	TENSOR PARA BANDA MICRO-V	

**CAMARO Z28**

V8, 5.7 L	2002	38006	TENSOR	
		38008	TENSOR	
		38041	TENSOR	

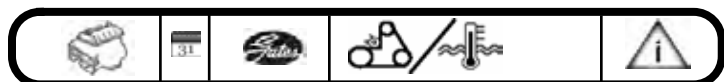

V8, 5.7 L	2001	38041 38006 38008	TENSOR TENSOR TENSOR
V8, 5.7 L	2000	38006 38008 38041	TENSOR TENSOR TENSOR
V8, 5.7 L	1999	38008 38006	TENSOR TENSOR
V8, 5.7 L	1998	38006 38008	TENSOR TENSOR
V8, 5.7 L	1997	38145 38001	TENSOR TENSOR
V8, 5.7 L	1996	38145 38001	TENSOR TENSOR



4 CIL. 2.4 L	1996	38026 38146 38011	TENSOR TENSOR TENSOR
4 CIL. 2.2 L	1995	38110 38026 38011	TENSOR TENSOR TENSOR
4 CIL. 2.3 L	1995	38146 38146	TENSOR TENSOR PARA BANDA MICRO-V
4 CIL. 2.2 L	1994	38026 38109 38105	TENSOR TENSOR TENSOR
V6, 3.1 L	1994	38105 38007	TENSOR TENSOR
4 CIL. 2.2 L	1993	38109 38026 38007	TENSOR TENSOR TENSOR
V6, 3.1 L	1993	38007 38009 38105	TENSOR TENSOR TENSOR
4 CIL. 2.0 L	1989	38026 38109	POLEA TENSOR PARA BANDA MICRO-V
V6, 2.8 L	1989	38105 38105	TENSOR PARA BANDA MICRO-V TENSOR PARA BANDA MICRO-V

**CAPRICE**

V8, 4.3 L	1996	38001	POLEA
-----------	------	-------	-------

**CAPTIVA**

4 CIL. 2.4 L	2010	36193 38011 38177	POLEA TENSOR TENSOR
V6, 3.6 L	2010	38397	TENSOR
4 CIL. 2.4 L	2009	36193 38177 38011	POLEA TENSOR TENSOR
V6, 3.6 L	2009	38397	TENSOR
4 CIL. 2.4 L	2008	38011 38177 38011 38177	POLEA TENSOR TENSOR TENSOR PARA BANDA MICRO-V
V6, 3.6 L	2008	38397 38397	TENSOR TENSOR PARA BANDA MICRO-V

**CAVALIER Z24**

4 CIL. 2.4 L	2002	38032 38247	TENSOR TENSOR
4 CIL. 2.4 L	2001	38032 38247	TENSOR TENSOR
4 CIL. 2.4 L	2000	38032 38247	TENSOR TENSOR
4 CIL. 2.4 L	1999	38032 38247	TENSOR TENSOR
4 CIL. 2.4 L	1998	38247 38032	TENSOR TENSOR

**CELEBRITY**

4 CIL. 2.5 L	1989	38002 38111	POLEA TENSOR PARA BANDA MICRO-V
--------------	------	----------------	------------------------------------

**CENTURY**

V6, 3.1 L	2000	38001	POLEA
V6, 3.1 L	1999	38105 38001	TENSOR TENSOR
V6, 3.1 L	1998	38105 38001	TENSOR TENSOR
V6, 3.1 L	1997	38007 38105	TENSOR TENSOR
V6, 3.1 L	1996	38105 38007	TENSOR TENSOR
V6, 3.1 L	1995	38007 38105	TENSOR TENSOR
V6, 3.1 L	1994	38007 38105	TENSOR TENSOR

**CAVALIER**

4 CIL. 2.2 L	2005	38177 38011	TENSOR TENSOR
4 CIL. 2.2 L	2004	38177 38011	TENSOR TENSOR
4 CIL. 2.2 L	2003	38177 38011	TENSOR TENSOR
4 CIL. 2.2 L	2002	38164 38011 38015 38177	TENSOR TENSOR TENSOR TENSOR
4 CIL. 2.4 L	2002	38164 38032 38247	TENSOR PARA BANDA MICRO-V POLEA TENSOR PARA BANDA MICRO-V
4 CIL. 2.2 L	2001	38011 38164 38015	TENSOR TENSOR TENSOR
4 CIL. 2.2 L	2000	38164 38015 38011	TENSOR TENSOR TENSOR
4 CIL. 2.2 L	1999	38015 38164 38011	TENSOR TENSOR TENSOR
4 CIL. 2.4 L	1999	38032 38247	TENSOR TENSOR
4 CIL. 2.2 L	1998	38015 38164 38011	TENSOR TENSOR TENSOR
4 CIL. 2.4 L	1998	38146 38011	TENSOR TENSOR
4 CIL. 2.2 L	1997	38026 38110 38110	TENSOR TENSOR TENSOR PARA BANDA MICRO-V
4 CIL. 2.4 L	1997	38011 38146	TENSOR TENSOR
4 CIL. 2.2 L	1996	38110	TENSOR

**COLORADO**

4 CIL. 2.9 L	2010	36301 36101 38178	POLEA POLEA TENSOR
5 CIL. 3.7 L	2010	36101 36301 38178	POLEA POLEA TENSOR
4 CIL. 2.9 L	2009	36101 36301 38178	POLEA POLEA TENSOR
5 CIL. 3.7 L	2009	36101 36301 38178	POLEA POLEA TENSOR
4 CIL. 2.9 L	2008	36301 36101 38178	POLEA POLEA TENSOR
5 CIL. 3.7 L	2008	36301 36101 38178	POLEA POLEA TENSOR



5 CIL. 3.7 L	2008	38178	SENSOR	
4 CIL. 2.9 L	2007	36101	POLEA	
		38178	SENSOR	
5 CIL. 3.7 L	2007	36101	POLEA	
		38178	SENSOR	
4 CIL. 2.8 L	2006	36101	POLEA	
		36101	POLEA	
		38018	SENSOR	
		38178	SENSOR	
5 CIL. 3.5 L	2006	38178	SENSOR PARA BANDA MICRO-V	
		36101	POLEA	
		38178	SENSOR	
		38018	SENSOR	
4 CIL. 2.8 L	2005	36101	POLEA	
		38018	SENSOR	
		38178	SENSOR	
5 CIL. 3.5 L	2005	36101	POLEA	
		38178	SENSOR	
		38018	SENSOR	
5 CIL. 3.5 L	2004	36101	POLEA	
		38178	SENSOR	
		38018	SENSOR	

V8, 5.7 L	2000	38006	SENSOR	
		38006	SENSOR	
		38194	SENSOR	ACCESORIO
		38196	SENSOR	A.A.
		38008	SENSOR	
V8, 5.7 L	1999	38194	SENSOR	ACCESORIO
		38006	SENSOR	
		38008	SENSOR	
		38196	SENSOR	A.A.
V8, 5.7 L	1998	38196	SENSOR	A.A.
		38008	SENSOR	
		38194	SENSOR	ACCESORIO
		38006	SENSOR	
V8, 5.7 L	1997	38194	SENSOR	ACCESORIO
		38196	SENSOR	A.A.
		38008	SENSOR	
V8, 5.7 L	1996	38006	SENSOR	
		38015	SENSOR	
V8, 5.7 L	1995	38015	SENSOR	
V8, 5.7 L	1994	38015	SENSOR	
V8, 5.7 L	1993	38015	SENSOR	
		38009	SENSOR	

**CORSA**

4 CIL. 1.8 L	2009	TPG-14004	SENSOR ARBOL DE LEVAS	
		TMV-14001	SENSOR MICRO-V	
4 CIL. 1.8 L	2008	TPG-14004	SENSOR ARBOL DE LEVAS	
		TMV-14001	SENSOR MICRO-V	
4 CIL. 1.8 L	2007	TPG-14004	SENSOR ARBOL DE LEVAS	
		TMV-14001	SENSOR MICRO-V	
4 CIL. 1.8 L	2006	TPG-14004	SENSOR ARBOL DE LEVAS	
		TMV-14001	SENSOR MICRO-V	
4 CIL. 1.8 L	2005	TPG-14004	SENSOR ARBOL DE LEVAS	
		TMV-14001	SENSOR MICRO-V	
4 CIL. 1.8 L	2004	TPG-14004	SENSOR ARBOL DE LEVAS	
		TMV-14001	SENSOR MICRO-V	
4 CIL. 1.4 L	2003	TCK1094	KIT DE DISTRIBUCION	
		TPG-14004	SENSOR ARBOL DE LEVAS	
		TMV-14001	SENSOR MICRO-V	
4 CIL. 1.8 L	2003	TPG-14004	SENSOR ARBOL DE LEVAS	
		TMV-14001	SENSOR MICRO-V	
4 CIL. 1.4 L	2002	TCK1094	KIT DE DISTRIBUCION	
		TPG-14004	SENSOR ARBOL DE LEVAS	
		TMV-14001	SENSOR MICRO-V	

**CRUZE**

4 CIL. 1.8 L	2011	T38433	TENSOR- POLEA DE DIST.	A.A.
4 CIL. 1.8 L	2010	T38433	TENSOR- POLEA DE DIST.	A.A.

**CUTLASS**

V6, 3.1 L	1998	38104	SENSOR	
		38009	SENSOR	
		38006	SENSOR	
		38104	SENSOR PARA BANDA MICRO-V	
V6, 3.1 L	1997	38104	SENSOR	
		38009	SENSOR	
		38006	SENSOR	
V6, 3.1 L	1996	38007	SENSOR	
		38105	SENSOR	
V6, 3.1 L	1995	38105	SENSOR	
		38007	SENSOR	
V6, 3.1 L	1994	38007	SENSOR	
		38105	SENSOR	
V6, 3.1 L	1993	38007	SENSOR	
		38105	SENSOR	

**CORVETTE**

V8, 6.0 L	2007	38009	SENSOR	SERPENTIN
		38328	SENSOR	ACCESORIO
		38008	SENSOR	ACCESORIO
V8, 6.0 L	2006	38009	SENSOR	SERPENTIN
		38008	SENSOR	ACCESORIO
		38328	SENSOR	ACCESORIO
V8, 6.0 L	2005	38008	SENSOR	ACCESORIO
		38009	SENSOR	
		38328	SENSOR	ACCESORIO
V8, 5.7 L	2004	38006	SENSOR	
		38008	SENSOR	SERPENTIN
		38196	SENSOR	A.A.
		38194	SENSOR	SERPENTIN
		38194	SENSOR PARA BANDA MICRO-V	SERPENTIN
V8, 5.7 L	2003	38008	SENSOR	
		38006	SENSOR	
		38196	SENSOR	A.A.
		38194	SENSOR	ACCESORIO
V8, 5.7 L	2002	38008	SENSOR	
		38194	SENSOR	ACCESORIO
		38196	SENSOR	A.A.
		38006	SENSOR	
V8, 5.7 L	2001	38008	SENSOR	
		38194	SENSOR	ACCESORIO
		38196	SENSOR	A.A.

**CHEVY**

4 CIL. 1.6 L	2010	TCK203	KIT DE DISTRIBUCION	
		36152	POLEA	
		38200	SENSOR	
		TPG-14003	SENSOR ARBOL DE LEVAS	
		T36038	TENSOR- POLEA DE DIST.	CON A.A.
4 CIL. 1.6 L	2010	TCKWP203	KIT DE DISTRIBUCION CON B.A.	
4 CIL. 1.6 L	2009	TCK203	KIT DE DISTRIBUCION	
		36152	POLEA	
		38200	SENSOR	
		TPG-14003	SENSOR ARBOL DE LEVAS	
		T36038	TENSOR- POLEA DE DIST.	CON A.A.
4 CIL. 1.6 L	2009	TCKWP203	KIT DE DISTRIBUCION CON B.A.	
4 CIL. 1.6 L	2008	TCKWP203	KIT DE DISTRIBUCION CON B.A.	
4 CIL. 1.6 L	2007	TCKWP203	KIT DE DISTRIBUCION CON B.A.	
4 CIL. 1.6 L	2006	TCKWP203	KIT DE DISTRIBUCION CON B.A.	
4 CIL. 1.6 L	2005	TPG-14003	SENSOR ARBOL DE LEVAS	
4 CIL. 1.6 L	2005	TCKWP203	KIT DE DISTRIBUCION CON B.A.	
4 CIL. 1.6 L	2004	TCKWP203	KIT DE DISTRIBUCION CON B.A.	
4 CIL. 1.6 L	2003	TCKWP203	KIT DE DISTRIBUCION CON B.A.	
4 CIL. 1.6 L	2002	TCKWP203	KIT DE DISTRIBUCION CON B.A.	
4 CIL. 1.6 L	2001	TCKWP203	KIT DE DISTRIBUCION CON B.A.	
4 CIL. 1.6 L	2000	TCKWP203	KIT DE DISTRIBUCION CON B.A.	
4 CIL. 1.6 L	1999	TCKWP203	KIT DE DISTRIBUCION CON B.A.	
4 CIL. 1.6 L	1998	TCKWP203	KIT DE DISTRIBUCION CON B.A.	

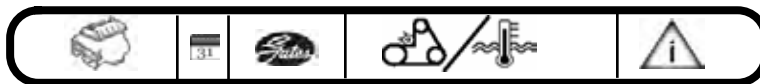
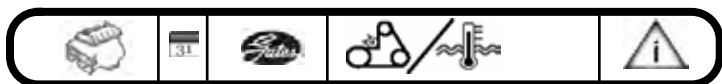

**CHEVY C2**

4 CIL. 1.6 L	2008	TCK203 36152 38200 TPG-14003 T36038	KIT DE DISTRIBUCION POLEA TENSOR TENSOR ARBOL DE LEVAS TENSOR- POLEA DE DIST.
4 CIL. 1.6 L	2007	TCK203 36152 38200 TPG-14003 T36038	KIT DE DISTRIBUCION POLEA TENSOR TENSOR ARBOL DE LEVAS TENSOR- POLEA DE DIST.
4 CIL. 1.6 L	2006	TCK203 36152 38200 TPG-14003 T36038	KIT DE DISTRIBUCION POLEA TENSOR TENSOR ARBOL DE LEVAS TENSOR- POLEA DE DIST.
4 CIL. 1.6 L	2005	TCK203 36152 38200 TPG-14003 T36038	KIT DE DISTRIBUCION POLEA TENSOR TENSOR ARBOL DE LEVAS TENSOR- POLEA DE DIST.
4 CIL. 1.6 L	2004	TCK203 36152 38200 TPG-14003 T36038	KIT DE DISTRIBUCION POLEA TENSOR TENSOR ARBOL DE LEVAS TENSOR- POLEA DE DIST.

4 CIL. 1.6 L	1999	TPG-14003 T36038 TCK203 38200 TPG-14003 T36038	TENSOR ARBOL DE LEVAS TENSOR- POLEA DE DIST. KIT DE DISTRIBUCION TENSOR TENSOR ARBOL DE LEVAS TENSOR- POLEA DE DIST.
4 CIL. 1.6 L	1998	TCK203 36152 38200 TPG-14003 T36038	KIT DE DISTRIBUCION POLEA TENSOR TENSOR ARBOL DE LEVAS TENSOR- POLEA DE DIST.
4 CIL. 1.6 L	1997	TCK203 36152 38200 TPG-14003 T36038	KIT DE DISTRIBUCION POLEA TENSOR TENSOR ARBOL DE LEVAS TENSOR- POLEA DE DIST.
4 CIL. 1.6 L	1996	TCK203 36152 38200 TPG-14003 T36038	KIT DE DISTRIBUCION POLEA TENSOR TENSOR ARBOL DE LEVAS TENSOR- POLEA DE DIST.
4 CIL. 1.6 L	1995	TCK203 36152 38200 TPG-14003 T36038	KIT DE DISTRIBUCION POLEA TENSOR TENSOR ARBOL DE LEVAS TENSOR- POLEA DE DIST.
4 CIL. 1.6 L	1994	TCK203 36152 38200 TPG-14003 T36038	KIT DE DISTRIBUCION POLEA TENSOR TENSOR ARBOL DE LEVAS TENSOR- POLEA DE DIST.

**CHEVY C2 SEDAN**

4 CIL. 1.6 L	2008	TCK203 36152 38200 TPG-14003 T36038	KIT DE DISTRIBUCION POLEA TENSOR TENSOR ARBOL DE LEVAS TENSOR- POLEA DE DIST.
4 CIL. 1.6 L	2007	TCK203 36152 38200 TPG-14003 T36038	KIT DE DISTRIBUCION POLEA TENSOR TENSOR ARBOL DE LEVAS TENSOR- POLEA DE DIST.
4 CIL. 1.6 L	2006	TCK203 36152 38200 TPG-14003 T36038	KIT DE DISTRIBUCION POLEA TENSOR TENSOR ARBOL DE LEVAS TENSOR- POLEA DE DIST.
4 CIL. 1.6 L	2005	TCK203 36152 38200 TPG-14003 T36038	KIT DE DISTRIBUCION POLEA TENSOR TENSOR ARBOL DE LEVAS TENSOR- POLEA DE DIST.
4 CIL. 1.6 L	2004	TCK203 36152 38200 TPG-14003 T36038	KIT DE DISTRIBUCION POLEA TENSOR TENSOR ARBOL DE LEVAS TENSOR- POLEA DE DIST.

**CHEVY PICK-UP**

4 CIL. 1.6 L	2006	TCK203 36152 38200 TPG-14003 T36038	KIT DE DISTRIBUCION POLEA TENSOR TENSOR ARBOL DE LEVAS TENSOR- POLEA DE DIST.
4 CIL. 1.6 L	2005	TCK203 36152 38200 TPG-14003 T36038	KIT DE DISTRIBUCION POLEA TENSOR TENSOR ARBOL DE LEVAS TENSOR- POLEA DE DIST.
4 CIL. 1.6 L	2004	TCK203 36152 38200 TPG-14003 T36038	KIT DE DISTRIBUCION POLEA TENSOR TENSOR ARBOL DE LEVAS TENSOR- POLEA DE DIST.
4 CIL. 1.6 L	2003	TCK203 36152 38200 TPG-14003 T36038	KIT DE DISTRIBUCION POLEA TENSOR TENSOR ARBOL DE LEVAS TENSOR- POLEA DE DIST.
4 CIL. 1.6 L	2002	TCK203 36152 38200 TPG-14003 T36038	KIT DE DISTRIBUCION POLEA TENSOR TENSOR ARBOL DE LEVAS TENSOR- POLEA DE DIST.

**CHEVY JOY**

4 CIL. 1.6 L	2003	TCK203 38200 TPG-14003 T36038	KIT DE DISTRIBUCION TENSOR TENSOR ARBOL DE LEVAS TENSOR- POLEA DE DIST.
4 CIL. 1.6 L	2002	TCK203 38200 TPG-14003 T36038	KIT DE DISTRIBUCION TENSOR TENSOR ARBOL DE LEVAS TENSOR- POLEA DE DIST.
4 CIL. 1.6 L	2001	TCK203 38200 TPG-14003 T36038	KIT DE DISTRIBUCION TENSOR TENSOR ARBOL DE LEVAS TENSOR- POLEA DE DIST.
4 CIL. 1.6 L	2000	TCK203 38200	KIT DE DISTRIBUCION TENSOR

**CHEVY POP**

4 CIL. 1.6 L	2003	TCK203 36152 38200 TPG-14003 T36038	KIT DE DISTRIBUCION POLEA TENSOR TENSOR ARBOL DE LEVAS TENSOR- POLEA DE DIST.
4 CIL. 1.6 L	2002	TCK203 36152 38200 TPG-14003 T36038	KIT DE DISTRIBUCION POLEA TENSOR TENSOR ARBOL DE LEVAS TENSOR- POLEA DE DIST.
4 CIL. 1.6 L	2001	TCK203	KIT DE DISTRIBUCION

4 CIL. 1.6 L	2001	36152 38200 TPG-14003 T36038	POLEA TENSOR TENSOR ARBOL DE LEVAS TENSOR- POLEA DE DIST.	
4 CIL. 1.6 L	2000	TCK203 36152 38200 TPG-14003 T36038	KIT DE DISTRIBUCION POLEA TENSOR TENSOR ARBOL DE LEVAS TENSOR- POLEA DE DIST.	
4 CIL. 1.6 L	1999	TCK203 36152 38200 TPG-14003 T36038	KIT DE DISTRIBUCION POLEA TENSOR TENSOR ARBOL DE LEVAS TENSOR- POLEA DE DIST.	
4 CIL. 1.6 L	1998	TCK203 36152 38200 TPG-14003 T36038	KIT DE DISTRIBUCION POLEA TENSOR TENSOR ARBOL DE LEVAS TENSOR- POLEA DE DIST.	
4 CIL. 1.6 L	1997	TCK203 36152 38200 TPG-14003 T36038	KIT DE DISTRIBUCION POLEA TENSOR TENSOR ARBOL DE LEVAS TENSOR- POLEA DE DIST.	
4 CIL. 1.6 L	1996	TCK203 36152 38200 TPG-14003 T36038	KIT DE DISTRIBUCION POLEA TENSOR TENSOR ARBOL DE LEVAS TENSOR- POLEA DE DIST.	
4 CIL. 1.6 L	1995	TCK203 36152 38200 TPG-14003 T36038	KIT DE DISTRIBUCION POLEA TENSOR TENSOR ARBOL DE LEVAS TENSOR- POLEA DE DIST.	
4 CIL. 1.6 L	1994	TCK203 36152 38200 TPG-14003 T36038	KIT DE DISTRIBUCION POLEA TENSOR TENSOR ARBOL DE LEVAS TENSOR- POLEA DE DIST.	

4 CIL. 1.6 L	1996	36152 38200 TPG-14003 T36038	POLEA TENSOR TENSOR ARBOL DE LEVAS TENSOR- POLEA DE DIST.	
4 CIL. 1.6 L	1995	TCK203 36152 38200 TPG-14003 T36038	KIT DE DISTRIBUCION POLEA TENSOR TENSOR ARBOL DE LEVAS TENSOR- POLEA DE DIST.	
4 CIL. 1.6 L	1994	TCK203 36152 38200 TPG-14003 T36038	KIT DE DISTRIBUCION POLEA TENSOR TENSOR ARBOL DE LEVAS TENSOR- POLEA DE DIST.	

**EPICA**

6 CIL. 2.5 L	2006	38273	TENSOR PARA BANDA MICRO-V	CANADA
--------------	------	-------	---------------------------	--------

**EQUINOX**

V6, 3.4 L	2007	38043 38043 38104 38006 38009	POLEA TENSOR TENSOR TENSOR TENSOR	
V6, 3.4 L	2006	38043 38104 38006 38009	TENSOR TENSOR TENSOR TENSOR	
V6, 3.4 L	2005	38009 38104 38043 38006	TENSOR TENSOR TENSOR TENSOR	C/AA C/AA

**CHEVY SWING**

4 CIL. 1.6 L	2003	TCK203 36152 38200 TPG-14003 T36038	KIT DE DISTRIBUCION POLEA TENSOR TENSOR ARBOL DE LEVAS TENSOR- POLEA DE DIST.	
4 CIL. 1.6 L	2002	TCK203 36152 38200 TPG-14003 T36038	KIT DE DISTRIBUCION POLEA TENSOR TENSOR ARBOL DE LEVAS TENSOR- POLEA DE DIST.	
4 CIL. 1.6 L	2001	TCK203 36152 38200 TPG-14003 T36038	KIT DE DISTRIBUCION POLEA TENSOR TENSOR ARBOL DE LEVAS TENSOR- POLEA DE DIST.	
4 CIL. 1.6 L	2000	TCK203 36152 38200 TPG-14003 T36038	KIT DE DISTRIBUCION POLEA TENSOR TENSOR ARBOL DE LEVAS TENSOR- POLEA DE DIST.	
4 CIL. 1.6 L	1999	TCK203 36152 38200 TPG-14003 T36038	KIT DE DISTRIBUCION POLEA TENSOR TENSOR ARBOL DE LEVAS TENSOR- POLEA DE DIST.	
4 CIL. 1.6 L	1998	TCK203 36152 38200 TPG-14003 T36038	KIT DE DISTRIBUCION POLEA TENSOR TENSOR ARBOL DE LEVAS TENSOR- POLEA DE DIST.	
4 CIL. 1.6 L	1997	TCK203	KIT DE DISTRIBUCION	

**EXPRESS**

V8, 5.3 L	2010	91030 36299 38009 39083	HERRAMIENTA INST. STRECH FIT POLEA TENSOR TENSOR	SERPENTIN SERPENTIN
V8, 6.0 L	2010	91030 36299 38009 39083	HERRAMIENTA INST. STRECH FIT POLEA TENSOR TENSOR	SERPENTIN SERPENTIN
V8, 5.3 L	2009	91030 36299 38009 39083	HERRAMIENTA INST. STRECH FIT POLEA TENSOR TENSOR	SERPENTIN SERPENTIN
V8, 6.0 L	2009	91030 36299 38009 39083	HERRAMIENTA INST. STRECH FIT POLEA TENSOR TENSOR	SERPENTIN SERPENTIN
V8, 5.3 L	2008	36169 36299 38159 38158 38009	POLEA POLEA TENSOR TENSOR TENSOR	A.A. A.A. SERPENTIN SERPENTIN
V8, 6.0 L	2008	36169 36299 38158 38159 38009	POLEA POLEA TENSOR TENSOR TENSOR	A.A. SERPENTIN SERPENTIN
V8, 5.3 L	2007	38158 38159 38009 38158 38159 38001 38009	TENSOR TENSOR TENSOR TENSOR TENSOR TENSOR TENSOR	SERPENTIN A.A. SERPENTIN SERPENTIN SERPENTIN
V8, 6.0 L	2007	38158	TENSOR	SERPENTIN





V8, 6.0 L	2007	38009	SENSOR	SERPENTIN	V6, 4.3 L	2000	38008	SENSOR	CON CANALES
		38001	SENSOR	SERPENTIN			38001	SENSOR	LISO
V8, 6.6 L	2007	38159	SENSOR	A.A.	V8, 5.0 L	2000	38103	SENSOR	S/AA
V8, 5.3 L	2006	38172	SENSOR PARA BANDA MICRO-V				38001	SENSOR	LISO
		38158	SENSOR	SERPENTIN			38008	SENSOR	CON CANALES
V8, 6.0 L	2006	38001	SENSOR	SERPENTIN	V8, 5.7 L	2000	38103	SENSOR	
		38159	SENSOR	A.A.			38008	SENSOR	CON CANALES
		38159	SENSOR	A.A.			38001	SENSOR	LISO
		38009	SENSOR	SERPENTIN	V8, 6.5 L	2000	38118	SENSOR	
		38001	SENSOR	SERPENTIN			38006	SENSOR	
		38158	SENSOR	SERPENTIN			38020	SENSOR	C/Doble Alt.
V8, 5.3 L	2005	38159	SENSOR	A.A.	V8, 7.4 L	2000	38103	SENSOR	
		38001	SENSOR	SERPENTIN			38008	SENSOR	CON CANALES
		38009	SENSOR	SERPENTIN			38001	SENSOR	LISO
V8, 6.0 L	2005	38001	SENSOR	SERPENTIN	V6, 4.3 L	1999	38008	SENSOR	CON CANALES
		38158	SENSOR	SERPENTIN			38103	SENSOR	S/AA
		38009	SENSOR	SERPENTIN			38001	SENSOR	LISO
		38159	SENSOR	A.A.	V8, 5.0 L	1999	38103	SENSOR	
V8, 5.3 L	2004	38159	SENSOR	A.A.			38001	SENSOR	LISO
		38158	SENSOR	SERPENTIN			38008	SENSOR	CON CANALES
		38009	SENSOR	SERPENTIN	V8, 5.7 L	1999	38001	SENSOR	LISO
		38001	SENSOR	LISA			38103	SENSOR	
V8, 6.0 L	2004	38001	SENSOR	A.A.	V8, 6.5 L	1999	38020	SENSOR	CON CANALES
		38159	SENSOR	SERPENTIN			38118	SENSOR	C/Doble Alt.
		38158	SENSOR	SERPENTIN			38006	SENSOR	
		38009	SENSOR	SERPENTIN	V8, 7.4 L	1999	38001	SENSOR	LISO
V6, 4.3 L	2003	38008	SENSOR	LISO			38103	SENSOR	
		38001	SENSOR		V6, 4.3 L	1998	38008	SENSOR	CON CANALES
V8, 5.3 L	2003	38103	SENSOR	SERPENTIN			38103	SENSOR	CON CANALES
		38158	SENSOR	A.C.			38001	SENSOR	S/AA
		38159	SENSOR	SERPENTIN	V8, 5.0 L	1998	38008	SENSOR	CON CANALES
		38001	SENSOR	SERPENTIN			38001	SENSOR	LISO
V8, 6.0 L	2003	38158	SENSOR	SERPENTIN			38103	SENSOR	
		38001	SENSOR	SERPENTIN	V8, 5.7 L	1998	38001	SENSOR	LISO
		38159	SENSOR	A.C.			38103	SENSOR	
		38009	SENSOR	SERPENTIN			38008	SENSOR	CON CANALES
V6, 4.3 L	2002	38103	SENSOR	CON CANALES	V8, 7.4 L	1998	38008	SENSOR	CON CANALES
		38008	SENSOR	LISO			38001	SENSOR	LISO
		38001	SENSOR		V6, 4.3 L	1997	38008	SENSOR	CON CANALES
V8, 5.0 L	2002	38103	SENSOR	LISO			38001	SENSOR	LISO
		38001	SENSOR	CON CANALES	V8, 5.0 L	1997	38008	SENSOR	CON CANALES
		38008	SENSOR	CON CANALES			38001	SENSOR	LISO
V8, 5.7 L	2002	38103	SENSOR	LISO			38103	SENSOR	
		38001	SENSOR		V8, 5.7 L	1997	38103	SENSOR	
V8, 6.5 L	2002	38006	SENSOR	C/Doble Alt 105A.			38008	SENSOR	CON CANALES
		38020	SENSOR				38001	SENSOR	LISO
		38118	SENSOR		V8, 7.4 L	1997	38001	SENSOR	LISO
V8, 8.1 L	2002	38006	SENSOR	S/AA			38103	SENSOR	SERPENTIN
		38258	SENSOR	CON CANALES			38008	SENSOR	CON CANALES
		38008	SENSOR	LISO	V6, 4.3 L	1996	38103	SENSOR	
		38008	SENSOR	LISO			38008	SENSOR	CON CANALES
V6, 4.3 L	2001	38001	SENSOR	LISO			38001	SENSOR	LISO
		38008	SENSOR	CON CANALES	V8, 5.0 L	1996	38103	SENSOR	
		38103	SENSOR				38008	SENSOR	CON CANALES
V8, 5.0 L	2001	38103	SENSOR	LISO			38001	SENSOR	LISO
		38001	SENSOR	CON CANALES	V8, 5.7 L	1996	38103	SENSOR	
		38008	SENSOR	LISO			38008	SENSOR	CON CANALES
V8, 5.7 L	2001	38001	SENSOR	CON CANALES			38001	SENSOR	LISO
		38103	SENSOR		V8, 7.4 L	1996	38103	SENSOR	SERPENTIN
		38008	SENSOR	CON CANALES			38001	SENSOR	LISO
V8, 6.5 L	2001	38006	SENSOR	C/Doble Alt 105A.			38008	SENSOR	LISO
		38020	SENSOR				38008	SENSOR	CON CANALES
		38118	SENSOR						
V8, 8.1 L	2001	38001	SENSOR	LISO					
		38258	SENSOR						
		38008	SENSOR	S/AA					
		38006	SENSOR	CON CANALES					
		38008	SENSOR						

**EXPRESS CARGO VAN**

V6, 4.3 L	2010	36299	POLEA
		38008	SENSOR
		38008	SENSOR
		38103	SENSOR

V6, 4.3 L	2009	36299 38103 38008 38008	POLEA TENSOR TENSOR TENSOR	
V6, 4.3 L	2008	36299 38103 38008 38008	POLEA TENSOR TENSOR TENSOR	
V6, 4.3 L	2007	38103 38008 38001	TENSOR TENSOR TENSOR	MICRO RANURADA S/AA LISA
V6, 4.3 L	2006	38008 38103 38001	TENSOR TENSOR TENSOR	RANURADA S/AA MICRO LISA
V6, 4.3 L	2005	38103 38008 38001	TENSOR TENSOR TENSOR	MICRO RANURADA S/AA LISA
V6, 4.3 L	2004	38001 38008	TENSOR TENSOR	LOCA LOCA

V6, 3.4 L	1997	38105 TCK192 TCK273 38198 38027 38198 T42113 T41209	TENSOR KIT DE DISTRIBUCION KIT DE DISTRIBUCION TENSOR TENSOR TENSOR PARA BANDA MICRO-V TENSOR- POLEA DE DIST. TENSOR- POLEA DE DIST.	
V6, 3.1 L	1996	38105 38007	TENSOR TENSOR	
V6, 3.4 L	1996	TCK273 38198 38027 T42113 T41209	KIT DE DISTRIBUCION TENSOR TENSOR TENSOR- POLEA DE DIST. TENSOR- POLEA DE DIST.	
V6, 3.4 L	1995	TCK192 38105 38198 38027 T41209 T42113	KIT DE DISTRIBUCION TENSOR TENSOR TENSOR TENSOR- POLEA DE DIST. TENSOR- POLEA DE DIST.	
V6, 3.4 L	1994	TCK192 38027 38198 38105 T42113 T41209	KIT DE DISTRIBUCION TENSOR TENSOR TENSOR TENSOR- POLEA DE DIST. TENSOR- POLEA DE DIST.	
V6, 3.4 L	1993	TCK192 38027 38198 38105 T42113 T41209	KIT DE DISTRIBUCION TENSOR TENSOR TENSOR TENSOR- POLEA DE DIST. TENSOR- POLEA DE DIST.	
V6, 3.4 L	1992	T42113 T41209 T42113 T41209	TENSOR- POLEA DE DIST. TENSOR- POLEA DE DIST. TENSOR- POLEA DE DIST. TENSOR- POLEA DE DIST.	

**HHR**

4 CIL. 2.4 L	2010	36193 38177	POLEA TENSOR	
4 CIL. 2.4 L	2009	36193 38177	POLEA TENSOR	
4 CIL. 2.4 L	2008	38177	TENSOR	
4 CIL. 2.4 L	2007	38011 38177	TENSOR TENSOR	
4 CIL. 2.4 L	2006	38177 38011	TENSOR TENSOR	

**IMPALA**

V6, 3.4 L	2005	38001 38105	TENSOR TENSOR	
V6, 3.8 L	2005	38006 38007 38009 38271 38001 38271	TENSOR TENSOR TENSOR TENSOR TENSOR TENSOR PARA BANDA MICRO-V	LOCA LOCA
V6, 3.4 L	2004	38001 38105	TENSOR TENSOR	SUPER CARGADO (LISO)
V6, 3.8 L	2004	38006 38271 38009 38007	TENSOR TENSOR TENSOR TENSOR	ACCESORIO RANURADA, C/SC Lisa, C/SC
V6, 3.4 L	2003	38001 38105	TENSOR TENSOR	
V6, 3.8 L	2003	38271 38006	TENSOR TENSOR	
V6, 3.4 L	2002	38001 38105	TENSOR TENSOR	
V6, 3.8 L	2002	38006 38271	TENSOR TENSOR	
V6, 3.4 L	2001	38001 38105	TENSOR TENSOR	
V6, 3.8 L	2001	38271 38006	TENSOR TENSOR	
V6, 3.4 L	2000	38001 38105	TENSOR TENSOR	
V6, 3.8 L	2000	38271 38006	TENSOR TENSOR	

**MALIBU**

4 CIL. 2.4 L	2010	36193 38177	POLEA TENSOR	
V6, 3.6 L	2010	38397	TENSOR	
4 CIL. 2.4 L	2009	36193 38177	POLEA TENSOR	
V6, 3.6 L	2009	38397	TENSOR	
4 CIL. 2.4 L	2008	36193 38177	POLEA TENSOR	
V6, 3.6 L	2008	38397	TENSOR	
4 CIL. 2.2 L	2007	38177 38011	TENSOR TENSOR	
V6, 3.5 L	2007	38420 38006 38009	TENSOR TENSOR TENSOR	LISA RANURADA CON CANALES
4 CIL. 2.2 L	2006	38177 38011	TENSOR TENSOR	
V6, 3.5 L	2006	38006 38009 38043 38104	TENSOR TENSOR TENSOR TENSOR	LISA RANURADA LISO
4 CIL. 2.2 L	2005	38011 38177	TENSOR TENSOR	
V6, 3.5 L	2005	38043 38006 38009 38104	TENSOR TENSOR TENSOR TENSOR	LISO LOCA LOCA
4 CIL. 2.2 L	2004	38177 38011	TENSOR TENSOR	
V6, 3.5 L	2004	38104 38009 38006 38043	TENSOR TENSOR TENSOR TENSOR	
V6, 3.1 L	2003	38006	TENSOR	LISO

**LUMINA**

V6, 3.1 L	1998	38001	TENSOR	
V6, 3.4 L	1998	TCK192	KIT DE DISTRIBUCION	
V6, 3.8 L	1998	38152 38015 38006	TENSOR TENSOR TENSOR	
V6, 3.1 L	1997	38007	TENSOR	

V6, 3.1 L	2003	38104	TENSOR	
		38043	TENSOR	
		38009	TENSOR	
V6, 3.1 L	2002	38006	TENSOR	
		38009	TENSOR	
		38043	TENSOR	
		38104	TENSOR	
V6, 3.1 L	2001	38104	TENSOR	
		38009	TENSOR	
		38006	TENSOR	
V6, 3.1 L	2000	38006	TENSOR	
		38104	TENSOR	
		38009	TENSOR	
V6, 3.1 L	1999	38009	TENSOR	
		38006	TENSOR	
		38104	TENSOR	
4 CIL. 2.4 L	1998	38011	TENSOR	
		38146	TENSOR	
V6, 3.1 L	1998	38104	TENSOR	
		38006	TENSOR	
		38009	TENSOR	
4 CIL. 2.4 L	1997	38011	TENSOR	
		38146	TENSOR	
V6, 3.1 L	1997	38104	TENSOR	
		38006	TENSOR	
		38009	TENSOR	

**MATIZ**

4 CIL. 1.0 L	2011	TCK1570M	KIT DE DISTRIBUCION	
4 CIL. 1.0 L	2010	TCK1570M	KIT DE DISTRIBUCION	

**MERIVA**

4 CIL. 1.8 L	2008	TPG-14004	TENSOR ARBOL DE LEVAS	
		TMV-14001	TENSOR MICRO-V	
4 CIL. 1.8 L	2007	TPG-14004	TENSOR ARBOL DE LEVAS	
		TMV-14001	TENSOR PARA BANDA MICRO-V	
4 CIL. 1.8 L	2006	TPG-14004	TENSOR ARBOL DE LEVAS	
		TMV-14001	TENSOR PARA BANDA MICRO-V	
4 CIL. 1.8 L	2005	TPG-14004	TENSOR ARBOL DE LEVAS	
		TMV-14001	TENSOR PARA BANDA MICRO-V	

**METRO**

3 CIL. 1.0 L	2000	T41010	TENSOR- POLEA DE DIST.	
		T41010	TENSOR- POLEA DE DIST.	
3 CIL. 1.0 L	1999	T41010	TENSOR- POLEA DE DIST.	
		T41010	TENSOR- POLEA DE DIST.	
3 CIL. 1.0 L	1998	T41010	TENSOR- POLEA DE DIST.	
		T41010	TENSOR- POLEA DE DIST.	

**MONTE CARLO**

V6, 3.4 L	2005	38105	TENSOR	
		38001	TENSOR	
V6, 3.8 L	2005	38006	TENSOR	
V6, 3.4 L	2004	38105	TENSOR	
		38001	TENSOR	
V6, 3.8 L	2004	38006	TENSOR	
V6, 3.4 L	1997	T41209	TENSOR- POLEA DE DIST.	
		T42113	TENSOR- POLEA DE DIST.	POLEA TENSORA
V6, 3.4 L	1996	T42113	TENSOR- POLEA DE DIST.	POLEA TENSORA
		T41209	TENSOR- POLEA DE DIST.	
V6, 3.4 L	1995	T41209	TENSOR- POLEA DE DIST.	
		T42113	TENSOR- POLEA DE DIST.	POLEA TENSORA

**MONZA**

4 CIL. 1.6 L	2004	TCK203	KIT DE DISTRIBUCION	
		38200	TENSOR	
		TPG-14003	TENSOR ARBOL DE LEVAS	
		T36038	TENSOR- POLEA DE DIST.	
4 CIL. 1.6 L	2003	TCK203	KIT DE DISTRIBUCION	

4 CIL. 1.6 L	2002	38200	TENSOR	
		TPG-14003	TENSOR ARBOL DE LEVAS	
		T36038	TENSOR- POLEA DE DIST.	
		TCK203	KIT DE DISTRIBUCION	
		38200	TENSOR	
		TPG-14003	TENSOR ARBOL DE LEVAS	
		T36038	TENSOR- POLEA DE DIST.	
4 CIL. 1.6 L	2001	TCK203	KIT DE DISTRIBUCION	
		38200	TENSOR	
		TPG-14003	TENSOR ARBOL DE LEVAS	
		T36038	TENSOR- POLEA DE DIST.	
4 CIL. 1.6 L	2000	TCK203	KIT DE DISTRIBUCION	
		38200	TENSOR	
		TPG-14003	TENSOR ARBOL DE LEVAS	
		T36038	TENSOR- POLEA DE DIST.	
4 CIL. 1.6 L	1999	TCK203	KIT DE DISTRIBUCION	
		38200	TENSOR	
		TPG-14003	TENSOR ARBOL DE LEVAS	
		T36038	TENSOR- POLEA DE DIST.	
4 CIL. 1.6 L	1998	TCK203	KIT DE DISTRIBUCION	
		38200	TENSOR	
		TPG-14003	TENSOR ARBOL DE LEVAS	
		T36038	TENSOR- POLEA DE DIST.	
4 CIL. 1.6 L	1997	TCK203	KIT DE DISTRIBUCION	
		38200	TENSOR	
		TPG-14003	TENSOR ARBOL DE LEVAS	
		T36038	TENSOR- POLEA DE DIST.	
4 CIL. 1.6 L	1996	TCK203	KIT DE DISTRIBUCION	
		38200	TENSOR	
		TPG-14003	TENSOR ARBOL DE LEVAS	
		T36038	TENSOR- POLEA DE DIST.	
4 CIL. 1.6 L	1995	TCK203	KIT DE DISTRIBUCION	
		38200	TENSOR	
		TPG-14003	TENSOR ARBOL DE LEVAS	
		T36038	TENSOR- POLEA DE DIST.	

**NOVA**

4 CIL. 1.6 L	1988	T41066	TENSOR- POLEA DE DIST.	
4 CIL. 1.6 L	1987	T41066	TENSOR- POLEA DE DIST.	
4 CIL. 1.6 L	1986	T41066	TENSOR- POLEA DE DIST.	
4 CIL. 1.6 L	1985	T41066	TENSOR- POLEA DE DIST.	

**OPTRA**

4 CIL. 2.0 L	2010	TCK309M	KIT DE DISTRIBUCION	
		TCK309M	KIT DE DISTRIBUCION	
		36152	POLEA	
		38200	TENSOR	
		TPG-14001	TENSOR ARBOL DE LEVAS	
4 CIL. 2.0 L	2009	TCK309M	KIT DE DISTRIBUCION	
		TCK309M	KIT DE DISTRIBUCION	
		36152	POLEA	
		38200	TENSOR	
		TPG-14001	TENSOR ARBOL DE LEVAS	
4 CIL. 2.0 L	2008	TCK309M	KIT DE DISTRIBUCION	
		TCK309M	KIT DE DISTRIBUCION	
		36152	POLEA	
		36152	POLEA	
		36152	POLEA	
		38200	TENSOR	
		TPG-14001	TENSOR ARBOL DE LEVAS	
4 CIL. 2.0 L	2007	TCK309M	KIT DE DISTRIBUCION	
		TCK309M	KIT DE DISTRIBUCION	
		36152	POLEA	
		36152	POLEA	
		38200	TENSOR	
		TPG-14001	TENSOR ARBOL DE LEVAS	
4 CIL. 2.0 L (Canada)	2007	38154	TENSOR PARA BANDA MICRO-V	

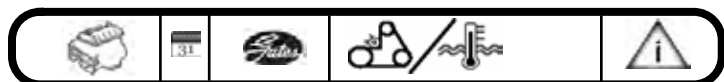

4 CIL. 2.0 L	2006	TCK309M TCK309M 36152 36152 38200 TPG-14001	KIT DE DISTRIBUCION KIT DE DISTRIBUCION POLEA POLEA TENSOR TENSOR ARBOL DE LEVAS	
4 CIL. 2.0 L (Canada)	2006	38154	TENSOR PARA BANDA MICRO-V	
4 CIL. 2.0 L (Canada)	2005	38154	TENSOR PARA BANDA MICRO-V	
4 CIL. 2.0 L (Canada)	2004	38154	TENSOR PARA BANDA MICRO-V	



	1993	38108 38001	TENSOR TENSOR	
--	------	----------------	------------------	--

**REGAL**

V6, 3.8 L	1996	38015 38152	TENSOR TENSOR	
V6, 3.8 L	1995	38027 38126	TENSOR TENSOR	
V6, 3.8 L	1994	38027 38126	TENSOR TENSOR	

**S SERIES PICKUP**

4 CIL. 2.2 L	2003	38165	TENSOR PARA BANDA MICRO-V	
4 CIL. 2.2 L	1997	38187	TENSOR PARA BANDA MICRO-V	

**S-10**

4 CIL. 2.2 L	2003	38015	TENSOR	LISA
4 CIL. 2.2 L	2002	38165 38015	TENSOR TENSOR	
V6, 4.3 L	2002	38001 38103	TENSOR TENSOR	
4 CIL. 2.2 L	2001	38165 38015	TENSOR TENSOR	
V6, 4.3 L	2001	38001 38008 38103	TENSOR TENSOR TENSOR	S/AA
4 CIL. 2.2 L	2000	38165 38015	TENSOR TENSOR	
V6, 4.3 L	2000	38001 38103 38008	TENSOR TENSOR TENSOR	S/AA
4 CIL. 2.2 L	1999	38015 38165	TENSOR TENSOR	
V6, 4.3 L	1999	38103 38001 38008	TENSOR TENSOR TENSOR	S/AA
4 CIL. 2.2 L	1998	38165 38015	TENSOR TENSOR	
V6, 4.3 L	1998	38001 38008 38103	TENSOR TENSOR TENSOR	S/AA
4 CIL. 2.2 L	1997	38001 38187	TENSOR TENSOR	
V6, 4.3 L	1997	38008 38103 38001	TENSOR TENSOR TENSOR	S/AA
4 CIL. 2.2 L	1996	38187 38001	TENSOR TENSOR	
V6, 4.3 L	1996	38103 38008 38001	TENSOR TENSOR TENSOR	S/AA
4 CIL. 2.2 L	1995	38001 38187	TENSOR TENSOR	
V6, 4.3 L	1995	38006 38001 38108 38024	TENSOR TENSOR TENSOR TENSOR	C/AA C/AA C/AA S/AA
4 CIL. 2.2 L	1994	38187 38001	TENSOR TENSOR	
V6, 4.3 L	1994	38024 38006 38108 38001	TENSOR TENSOR TENSOR TENSOR	S/AA C/AA

**SILVERADO**

V6, 4.3 L	2010	36299 38008 38008 38103	POLEA TENSOR TENSOR TENSOR	LISA RANURADA SIN A.A.
V8, 4.8 L	2010	91030 36299 39083	HERRAMIENTA INST. STRECH FIT POLEA TENSOR	
V8, 5.3 L	2010	91030 36299 38009	HERRAMIENTA INST. STRECH FIT POLEA TENSOR	SERPENTIN SERPENTIN
V6, 4.3 L	2009	36299 38103 38008 38008	POLEA TENSOR TENSOR TENSOR	LISA RANURADA SIN A.A.
V8, 4.8 L	2009	91030 36299 39083	HERRAMIENTA INST. STRECH FIT POLEA TENSOR	
V8, 5.3 L	2009	38009 91030 36299	TENSOR HERRAMIENTA INST. STRECH FIT POLEA	SERPENTIN SERPENTIN
V6, 4.3 L	2008	36299 38008 38103 38008	POLEA TENSOR TENSOR TENSOR	LISA RANURADA SIN A.A.
V8, 4.8 L	2008	36299 36169 38159	POLEA POLEA TENSOR	A.A. A.A.
V8, 5.3 L	2008	38009 38158 36299	TENSOR TENSOR POLEA	SERPENTIN SERPENTIN
V6, 4.3 L	2007	36169 38009 38158 38159	POLEA TENSOR TENSOR TENSOR	A.A. SERPENTIN SERPENTIN A.A.
V8, 4.8 L	2007	38001 38103 38001 38158	TENSOR TENSOR TENSOR TENSOR	LISA SERPENTIN A.A.
V8, 5.3 L	2007	38159 38009 38001 38158	TENSOR TENSOR TENSOR TENSOR	A.A. SERPENTIN SERPENTIN A.A.
V8, 6.0 L	2007	38159 38009 38001 38158	TENSOR TENSOR TENSOR TENSOR	A.A. SERPENTIN
V8, 6.6 L	2007	38008	TENSOR	
V8, 8.1 L	2007	38001 38009	TENSOR TENSOR	LISA
V6, 4.3 L	2006	38001 38103	TENSOR TENSOR	LISA
V8, 4.8 L	2006	38009 38001 38159 38158	TENSOR TENSOR TENSOR TENSOR	A.A. SERPENTIN SERPENTIN A.A.
V8, 5.3 L	2006	38159 38009 38001 38158	TENSOR TENSOR TENSOR TENSOR	A.A. SERPENTIN SERPENTIN A.A.
V8, 6.0 L	2006	38159 38158 38158	TENSOR TENSOR TENSOR	SERPENTIN A.A. SERPENTIN

V8, 6.0 L	2006	38001	TENSOR		V6, 4.3 L	2001	38103	TENSOR	S/AA
V8, 6.6 L	2006	38008	TENSOR				38008	TENSOR	
V8, 8.1 L	2006	38009	TENSOR				38008	TENSOR	S/AA
		38001	TENSOR	LISA			38001	TENSOR	
V6, 4.3 L	2005	38103	TENSOR		V8, 4.8 L	2001	38158	TENSOR	
		38001	TENSOR	LISA			38009	TENSOR	
V8, 4.8 L	2005	38009	TENSOR				38159	TENSOR	
		38159	TENSOR	A.A.			38001	TENSOR	
		38158	TENSOR	SERPENTIN	V8, 5.3 L	2001	38001	TENSOR	
V8, 5.3 L	2005	38001	TENSOR				38159	TENSOR	
		38159	TENSOR	A.A.			38009	TENSOR	
		38009	TENSOR				38158	TENSOR	
		38158	TENSOR	SERPENTIN	V8, 6.0 L	2001	38001	TENSOR	
V8, 6.0 L	2005	38001	TENSOR				38159	TENSOR	
		38159	TENSOR	A.A.			38158	TENSOR	
		38158	TENSOR	SERPENTIN	V8, 6.6 L	2001	38136	TENSOR	
		38009	TENSOR				38006	TENSOR	
V8, 6.6 L	2005	38008	TENSOR				38008	TENSOR	
V8, 8.1 L	2005	38009	TENSOR		V8, 8.1 L	2001	38009	TENSOR	
		38001	TENSOR	LISA			38001	TENSOR	
V6, 4.3 L	2004	38001	TENSOR	LISA	V6, 4.3 L	2000	38008	TENSOR	
		38103	TENSOR				38001	TENSOR	
V8, 4.8 L	2004	38001	TENSOR				38103	TENSOR	S/AA
		38009	TENSOR				38158	TENSOR	
		38158	TENSOR	SERPENTIN	V8, 5.3 L	2000	38009	TENSOR	
		38159	TENSOR	A.A.			38159	TENSOR	
V8, 5.3 L	2004	38158	TENSOR	SERPENTIN			38001	TENSOR	
		38159	TENSOR	A.A.	V8, 6.0 L	2000	38009	TENSOR	
		38001	TENSOR				38001	TENSOR	
V8, 6.0 L	2004	38009	TENSOR				38158	TENSOR	
		38158	TENSOR	SERPENTIN	V6, 4.3 L	1999	38103	TENSOR	S/AA
		38159	TENSOR	A.A.			38001	TENSOR	
		38001	TENSOR				38008	TENSOR	
V8, 6.6 L	2004	38008	TENSOR		<b>SILVERADO PICKUP</b>				
V8, 8.1 L	2004	38009	TENSOR						
		38001	TENSOR	LISA	V6, 4.3 L	2007	38001	POLEA	LISO
V6, 4.3 L	2003	38001	TENSOR	LISA			38008	POLEA	
		38103	TENSOR		V8, 4.8 L	2007	38103	TENSOR PARA BANDA MICRO-V	
V8, 4.8 L	2003	38158	TENSOR	SERPENTIN			38001	POLEA	SERPENTIN
		38159	TENSOR	A.A.			38009	POLEA	SERPENTIN
		38001	TENSOR				38158	TENSOR PARA BANDA MICRO-V	SERPENTIN
V8, 5.3 L	2003	38009	TENSOR				38159	TENSOR PARA BANDA MICRO-V	A.A.
		38158	TENSOR	SERPENTIN	V8, 5.3 L	2007	38009	POLEA	SERPENTIN
		38001	TENSOR				38001	POLEA	SERPENTIN
		38009	TENSOR				38159	TENSOR PARA BANDA MICRO-V	A.A.
V8, 6.0 L	2003	38001	TENSOR				38158	TENSOR PARA BANDA MICRO-V	SERPENTIN
		38009	TENSOR		V8, 6.0 L	2007	38001	POLEA	SERPENTIN
		38158	TENSOR	SERPENTIN			38009	POLEA	SERPENTIN
		38159	TENSOR	A.A.			38159	TENSOR PARA BANDA MICRO-V	A.A.
V8, 6.6 L	2003	38008	TENSOR				38158	TENSOR PARA BANDA MICRO-V	SERPENTIN
V8, 8.1 L	2003	38001	TENSOR	LISA	V8, 8.1 L	2007	38001	POLEA	SERPENTIN
		38009	TENSOR				38009	POLEA	SERPENTIN
V6, 4.3 L	2002	38103	TENSOR				38259	TENSOR PARA BANDA MICRO-V	A.A.
		38001	TENSOR				38260	TENSOR PARA BANDA MICRO-V	SERPENTIN
V8, 4.8 L	2002	38009	TENSOR		V6, 4.3 L	2006	38001	POLEA	LISO
		38001	TENSOR				38008	POLEA	
		38158	TENSOR				38103	TENSOR PARA BANDA MICRO-V	
V8, 5.3 L	2002	38159	TENSOR		V8, 4.8 L	2006	38001	POLEA	SERPENTIN
		38009	TENSOR				38009	POLEA	SERPENTIN
		38158	TENSOR				38158	TENSOR PARA BANDA MICRO-V	SERPENTIN
		38159	TENSOR				38159	TENSOR PARA BANDA MICRO-V	A.A.
V8, 6.0 L	2002	38001	TENSOR		V8, 5.3 L	2006	38009	POLEA	SERPENTIN
		38158	TENSOR				38001	POLEA	SERPENTIN
		38159	TENSOR				38158	TENSOR PARA BANDA MICRO-V	SERPENTIN
		38009	TENSOR		V8, 6.0 L	2006	38009	POLEA	A.A.
V8, 6.6 L	2002	38008	TENSOR				38001	POLEA	SERPENTIN
V8, 8.1 L	2002	38001	TENSOR				38159	TENSOR PARA BANDA MICRO-V	SERPENTIN
		38009	TENSOR				38158	TENSOR PARA BANDA MICRO-V	A.A.
		38001	TENSOR		V8, 8.1 L	2006	38009	POLEA	SERPENTIN
		38158	TENSOR				38001	POLEA	SERPENTIN
		38159	TENSOR				38159	TENSOR PARA BANDA MICRO-V	A.A.
		38009	TENSOR				38158	TENSOR PARA BANDA MICRO-V	SERPENTIN
V8, 6.6 L	2002	38008	TENSOR				38009	POLEA	A.A.
V8, 8.1 L	2002	38001	TENSOR				38159	TENSOR PARA BANDA MICRO-V	SERPENTIN
		38009	TENSOR				38158	TENSOR PARA BANDA MICRO-V	A.A.
		38001	TENSOR				38009	POLEA	SERPENTIN

V8, 8.1 L	2006	38001	POLEA	SERPENTIN		38009	POLEA	SERPENTIN
		38260	TENSOR PARA BANDA MICRO-V	SERPENTIN		38159	TENSOR PARA BANDA MICRO-V	A.A.
		38259	TENSOR PARA BANDA MICRO-V	A.A.		38158	TENSOR PARA BANDA MICRO-V	SERPENTIN
V6, 4.3 L	2005	38001	POLEA	LISO	V8, 8.1 L	2002	38009	POLEA
		38008	POLEA				38001	POLEA
		38103	TENSOR PARA BANDA MICRO-V				38260	TENSOR PARA BANDA MICRO-V
V8, 4.8 L	2005	38001	POLEA	SERPENTIN	V6, 4.3 L	2001	38259	TENSOR PARA BANDA MICRO-V
		38009	POLEA	SERPENTIN			38008	POLEA
		38159	TENSOR PARA BANDA MICRO-V	A.A.			38001	POLEA
		38158	TENSOR PARA BANDA MICRO-V	SERPENTIN			38103	TENSOR PARA BANDA MICRO-V
V8, 5.3 L	2005	38001	POLEA	SERPENTIN	V8, 4.8 L	2001	38009	POLEA
		38009	POLEA	SERPENTIN			38001	POLEA
		38159	TENSOR PARA BANDA MICRO-V	A.A.			38158	TENSOR PARA BANDA MICRO-V
		38158	TENSOR PARA BANDA MICRO-V	SERPENTIN			38159	TENSOR PARA BANDA MICRO-V
V8, 6.0 L	2005	38001	POLEA	SERPENTIN	V8, 5.3 L	2001	38009	POLEA
		38009	POLEA	SERPENTIN			38001	POLEA
		38159	TENSOR PARA BANDA MICRO-V	A.A.			38159	TENSOR PARA BANDA MICRO-V
		38158	TENSOR PARA BANDA MICRO-V	SERPENTIN			38158	TENSOR PARA BANDA MICRO-V
V8, 8.1 L	2005	38001	POLEA	SERPENTIN	V8, 6.0 L	2001	38001	POLEA
		38009	POLEA	SERPENTIN			38009	POLEA
		38260	TENSOR PARA BANDA MICRO-V	SERPENTIN			38158	TENSOR PARA BANDA MICRO-V
		38259	TENSOR PARA BANDA MICRO-V	A.A.			38159	TENSOR PARA BANDA MICRO-V
V6, 4.3 L	2004	38001	POLEA	LISO	V8, 8.1 L	2001	38009	POLEA
		38008	POLEA DEL TENSOR				38001	POLEA
		38103	TENSOR PARA BANDA MICRO-V				38260	TENSOR PARA BANDA MICRO-V
V8, 4.8 L	2004	38001	POLEA	SERPENTIN	V6, 4.3 L	2000	38259	TENSOR PARA BANDA MICRO-V
		38009	POLEA	SERPENTIN			38001	POLEA
		38158	TENSOR PARA BANDA MICRO-V	SERPENTIN			38008	POLEA
		38159	TENSOR PARA BANDA MICRO-V	AIRE ACONDICIONADO			38103	TENSOR PARA BANDA MICRO-V
V8, 5.3 L	2004	38009	POLEA	SERPENTIN	V8, 4.8 L	2000	38009	POLEA
		38001	POLEA	SERPENTIN			38001	POLEA
		38158	TENSOR PARA BANDA MICRO-V	SERPENTIN			38159	TENSOR PARA BANDA MICRO-V
		38159	TENSOR PARA BANDA MICRO-V	AIRE ACONDICIONADO			38158	TENSOR PARA BANDA MICRO-V
V8, 6.0 L	2004	38001	POLEA	SERPENTIN	V8, 5.3 L	2000	38001	POLEA
		38009	POLEA	SERPENTIN			38009	POLEA
		38159	TENSOR PARA BANDA MICRO-V	A.A.			38159	TENSOR PARA BANDA MICRO-V
		38158	TENSOR PARA BANDA MICRO-V	SERPENTIN			38158	TENSOR PARA BANDA MICRO-V
V8, 8.1 L	2004	38009	POLEA	SERPENTIN	V8, 6.0 L	2000	38009	POLEA
		38001	POLEA	SERPENTIN			38001	POLEA
		38260	TENSOR PARA BANDA MICRO-V	SERPENTIN			38158	TENSOR PARA BANDA MICRO-V
		38259	TENSOR PARA BANDA MICRO-V	A.A.			38159	TENSOR PARA BANDA MICRO-V
V6, 4.3 L	2003	38001	POLEA	LISO	V6, 4.3 L	1999	38001	POLEA
		38008	POLEA				38008	POLEA
		38103	TENSOR PARA BANDA MICRO-V				38103	TENSOR PARA BANDA MICRO-V
V8, 4.8 L	2003	38009	POLEA	SERPENTIN	V8, 4.8 L	1999	38001	POLEA
		38001	POLEA	SERPENTIN			38009	POLEA
		38158	TENSOR PARA BANDA MICRO-V	SERPENTIN			38158	TENSOR PARA BANDA MICRO-V
		38159	TENSOR PARA BANDA MICRO-V	A.A.			38159	TENSOR PARA BANDA MICRO-V
V8, 5.3 L	2003	38009	POLEA	SERPENTIN	V8, 5.3 L	1999	38009	POLEA
		38001	POLEA	SERPENTIN			38001	POLEA
		38158	TENSOR PARA BANDA MICRO-V	SERPENTIN			38158	TENSOR PARA BANDA MICRO-V
		38159	TENSOR PARA BANDA MICRO-V	A.A.			38159	TENSOR PARA BANDA MICRO-V
V8, 6.0 L	2003	38009	POLEA	SERPENTIN	V8, 6.0 L	1999	38009	POLEA
		38001	POLEA	SERPENTIN			38001	POLEA
		38158	TENSOR PARA BANDA MICRO-V	SERPENTIN			38158	TENSOR PARA BANDA MICRO-V
		38159	TENSOR PARA BANDA MICRO-V	A.A.			38159	TENSOR PARA BANDA MICRO-V
V8, 8.1 L	2003	38001	POLEA	SERPENTIN			38009	POLEA
		38009	POLEA	SERPENTIN			38001	POLEA
		38259	TENSOR PARA BANDA MICRO-V	A.A.			38158	TENSOR PARA BANDA MICRO-V
		38260	TENSOR PARA BANDA MICRO-V	SERPENTIN			38159	TENSOR PARA BANDA MICRO-V
V6, 4.3 L	2002	38008	POLEA	LISO			38009	POLEA
		38001	POLEA				38001	POLEA
		38103	TENSOR PARA BANDA MICRO-V				38158	TENSOR PARA BANDA MICRO-V
V8, 4.8 L	2002	38009	POLEA	SERPENTIN			38159	TENSOR PARA BANDA MICRO-V
		38001	POLEA	SERPENTIN			38009	POLEA
		38159	TENSOR PARA BANDA MICRO-V	A.A.			38158	TENSOR PARA BANDA MICRO-V
		38158	TENSOR PARA BANDA MICRO-V	SERPENTIN			38159	TENSOR PARA BANDA MICRO-V
V8, 5.3 L	2002	38001	POLEA	SERPENTIN			38009	POLEA
		38009	POLEA	SERPENTIN			38001	POLEA
		38159	TENSOR PARA BANDA MICRO-V	A.A.			38158	TENSOR PARA BANDA MICRO-V
		38158	TENSOR PARA BANDA MICRO-V	SERPENTIN			38159	TENSOR PARA BANDA MICRO-V
V8, 6.0 L	2002	38001	POLEA	SERPENTIN			38009	POLEA
		38009	POLEA	SERPENTIN			38001	POLEA
		38159	TENSOR PARA BANDA MICRO-V	A.A.			38158	TENSOR PARA BANDA MICRO-V
		38158	TENSOR PARA BANDA MICRO-V	SERPENTIN			38159	TENSOR PARA BANDA MICRO-V
		38001	POLEA	SERPENTIN			38009	POLEA

**SPECTRUM**

4 CIL. 1.5 L	1988	T41201	TENSOR- POLEA DE DIST.
4 CIL. 1.5 L	1987	T41201	TENSOR- POLEA DE DIST.
4 CIL. 1.5 L	1986	T41201	TENSOR- POLEA DE DIST.
4 CIL. 1.5 L	1985	T41201	TENSOR- POLEA DE DIST.

**SPRINT**

3 CIL. 1.0 L (Canada)	1991	T41009	TENSOR- POLEA DE DIST.
3 CIL. 1.0 L (Canada)	1990	T41009	TENSOR- POLEA DE DIST.
3 CIL. 1.0 L (Canada)	1989	T41009	TENSOR- POLEA DE DIST.

**SUBURBAN**

V8, 5.3 L	2010	91030	HERRAMIENTA INST. STRECH FIT
-----------	------	-------	------------------------------

V8, 5.3 L	2010	36299	POLEA	SERPENTIN	V8, 6.0 L	2003	38159	TENSOR	A.A.
		38009	TENSOR	SERPENTIN			38158	TENSOR	SERPENTIN
		39083	TENSOR	SERPENTIN			38009	TENSOR	SERPENTIN
V8, 6.0 L	2010	91030	HERRAMIENTA INST. STRECH FIT				38001	TENSOR	SERPENTIN
		36299	POLEA				38159	TENSOR	A.A.
		38009	TENSOR	SERPENTIN	V8, 8.1 L	2003	38001	TENSOR	SERPENTIN
		39083	TENSOR	SERPENTIN			38260	TENSOR	SERPENTIN
V8, 5.3 L	2009	91030	HERRAMIENTA INST. STRECH FIT				38259	TENSOR	A.A.
		36299	POLEA				38009	TENSOR	SERPENTIN
		38009	TENSOR	SERPENTIN	V8, 5.3 L	2002	38001	TENSOR	SERPENTIN
		39083	TENSOR	SERPENTIN			38009	TENSOR	SERPENTIN
V8, 6.0 L	2009	91030	HERRAMIENTA INST. STRECH FIT				38159	TENSOR	A.A.
		36299	POLEA				38158	TENSOR	SERPENTIN
		39083	TENSOR	SERPENTIN	V8, 6.0 L	2002	38159	TENSOR	A.A.
		38009	TENSOR	SERPENTIN			38009	TENSOR	SERPENTIN
V8, 5.3 L	2008	36169	POLEA	A.A.			38001	TENSOR	SERPENTIN
		36299	POLEA				38158	TENSOR	SERPENTIN
		38009	TENSOR	SERPENTIN	V8, 8.1 L	2002	38260	TENSOR	SERPENTIN
		38159	TENSOR	A.A.			38009	TENSOR	
		38158	TENSOR	SERPENTIN			38259	TENSOR	A.A.
V8, 6.0 L	2008	36169	POLEA	A.A.			38001	TENSOR	SERPENTIN
		36299	POLEA		V8, 5.3 L	2001	38159	TENSOR	
		38009	TENSOR	SERPENTIN			38158	TENSOR	
		38158	TENSOR	SERPENTIN			38009	TENSOR	SERPENTIN
		38159	TENSOR	A.A.	V8, 6.0 L	2001	38001	TENSOR	SERPENTIN
V8, 5.3 L	2007	38158	TENSOR	SERPENTIN			38009	TENSOR	SERPENTIN
		38009	TENSOR	SERPENTIN			38001	TENSOR	SERPENTIN
		38001	TENSOR	SERPENTIN			38158	TENSOR	
		38159	TENSOR	A.A.	V8, 8.1 L	2001	38159	TENSOR	
V8, 6.0 L	2007	38009	TENSOR	SERPENTIN			38009	TENSOR	SERPENTIN
		38158	TENSOR	SERPENTIN			38260	TENSOR	SERPENTIN
		38001	TENSOR	SERPENTIN			38001	TENSOR	SERPENTIN
		38159	TENSOR	A.A.	V8, 5.3 L	2000	38259	TENSOR	A.A.
V8, 5.3 L	2006	38009	TENSOR	SERPENTIN			38159	TENSOR	
		38158	TENSOR	SERPENTIN			38001	TENSOR	SERPENTIN
		38001	TENSOR	SERPENTIN			38009	TENSOR	SERPENTIN
		38159	TENSOR	A.A.	V8, 6.0 L	2000	38158	TENSOR	
V8, 6.0 L	2006	38159	TENSOR	A.A.			38158	TENSOR	
		38001	TENSOR	SERPENTIN			38159	TENSOR	
		38009	TENSOR	SERPENTIN			38009	TENSOR	SERPENTIN
		38158	TENSOR	SERPENTIN			38001	TENSOR	SERPENTIN
V8, 8.1 L	2006	38259	TENSOR	A.A.	V8, 5.7 L	1999	38008	TENSOR	
		38001	TENSOR	SERPENTIN			38103	TENSOR	S/AA
		38260	TENSOR	SERPENTIN			38001	TENSOR	
		38009	TENSOR	SERPENTIN	V8, 7.4 L	1999	38103	TENSOR	SERPENTIN
V8, 5.3 L	2005	38159	TENSOR	A.A.			38001	TENSOR	LISO
		38009	TENSOR	SERPENTIN			38008	TENSOR	CON CANALES
		38001	TENSOR	SERPENTIN	V8, 5.7 L	1998	38001	TENSOR	
		38158	TENSOR	SERPENTIN			38103	TENSOR	S/AA
V8, 6.0 L	2005	38159	TENSOR	A.A.	V8, 7.4 L	1998	38008	TENSOR	
		38009	TENSOR	SERPENTIN			38001	TENSOR	LISO
		38001	TENSOR	SERPENTIN			38008	TENSOR	CON CANALES
		38158	TENSOR	SERPENTIN	V8, 5.7 L	1997	38103	TENSOR	SERPENTIN
V8, 8.1 L	2005	38260	TENSOR	SERPENTIN			38008	TENSOR	S/AA
		38009	TENSOR	SERPENTIN			38103	TENSOR	S/AA
		38259	TENSOR	A.A.	V8, 7.4 L	1997	38001	TENSOR	
		38001	TENSOR	SERPENTIN			38103	TENSOR	SERPENTIN
V8, 5.3 L	2004	38159	TENSOR	A.A.	V8, 5.7 L	1996	38008	TENSOR	CON CANALES
		38158	TENSOR	SERPENTIN			38001	TENSOR	LISO
		38001	TENSOR	SERPENTIN	V8, 5.7 L	1996	38103	TENSOR	S/AA
		38009	TENSOR	SERPENTIN			38001	TENSOR	
V8, 6.0 L	2004	38158	TENSOR	SERPENTIN	V8, 7.4 L	1996	38008	TENSOR	
		38001	TENSOR	SERPENTIN			38001	TENSOR	LISO
		38009	TENSOR	SERPENTIN			38103	TENSOR	SERPENTIN
		38159	TENSOR	A.A.	V8, 5.7 L	1995	38008	TENSOR	CON CANALES
V8, 8.1 L	2004	38260	TENSOR	SERPENTIN			38001	TENSOR	C/AA
		38259	TENSOR	A.A.			38006	TENSOR	C/AA
		38001	TENSOR	SERPENTIN	V8, 7.4 L	1995	38024	TENSOR	S/AA
		38009	TENSOR	SERPENTIN			38108	TENSOR	C/AA
V8, 5.3 L	2003	38158	TENSOR	SERPENTIN	V8, 6.5 L Diesel	1995	38267	TENSOR PARA BANDA MICRO-V	
		38009	TENSOR	SERPENTIN	V8, 7.4 L	1995	38009	TENSOR	
		38001	TENSOR	SERPENTIN			38001	TENSOR	LISO

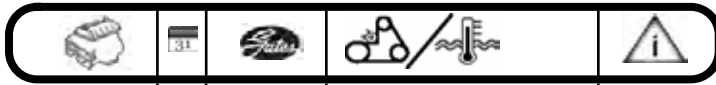

V8, 7.4 L	1995	38019	SENSOR	
V8, 5.7 L	1994	38001	SENSOR	C/AA
		38108	SENSOR	C/AA
		38006	SENSOR	C/AA
		38024	SENSOR	S/AA
V8, 6.5 L Diesel	1994	38267	SENSOR PARA BANDA MICRO-V	
V8, 7.4 L	1994	38019	SENSOR	
		38001	SENSOR	
		38009	SENSOR	
V8, 5.7 L	1993	38006	SENSOR	C/AA
		38024	SENSOR	S/AA
		38001	SENSOR	C/AA
		38108	SENSOR	C/AA
V8, 7.4 L	1993	38001	SENSOR	
		38143	SENSOR	
		38019	SENSOR	



**TRACKER**

4 CIL. 2.0 L	2003	38010	POLEA	
		38010	SENSOR	
		38156	SENSOR	
		38156	SENSOR PARA BANDA MICRO-V	
4 CIL. 1.6 L	2002	T41065	SENSOR- POLEA DE DIST.	CANADA
4 CIL. 1.6 L (Canada)	2002	T41065	SENSOR- POLEA DE DIST.	
4 CIL. 2.0 L	2002	38010	SENSOR	
		38156	SENSOR	
4 CIL. 1.6 L (Canada)	2001	T41065	SENSOR- POLEA DE DIST.	
4 CIL. 2.0 L	2001	38010	SENSOR	
		38156	SENSOR	
4 CIL. 1.6 L	2000	TCK212	KIT DE DISTRIBUCION	
		T41065	SENSOR- POLEA DE DIST.	
4 CIL. 2.0 L	2000	38156	SENSOR	
		38010	SENSOR	
4 CIL. 1.6 L	1999	TCK212	KIT DE DISTRIBUCION	
		T41065	SENSOR- POLEA DE DIST.	
4 CIL. 2.0 L	1999	38156	SENSOR	
		38010	SENSOR	
4 CIL. 1.6 L	1998	TCK212	KIT DE DISTRIBUCION	
		T41065	SENSOR- POLEA DE DIST.	
4 CIL. 1.6 L	1992	T41064	SENSOR- POLEA DE DIST.	CANADA
4 CIL. 1.6 L (Canada)	1992	T41064	SENSOR- POLEA DE DIST.	

**TAHOE**

V8, 5.3 L	2010	91030	HERRAMIENTA INST. STRECH FIT	
		36299	POLEA	
		39083	SENSOR	SERPENTIN
		38009	SENSOR	SERPENTIN
V8, 5.3 L	2009	91030	HERRAMIENTA INST. STRECH FIT	
		36299	POLEA	
		38009	SENSOR	SERPENTIN
		39083	SENSOR	SERPENTIN
V8, 5.3 L	2008	36169	POLEA	A.A.
		36299	POLEA	
		38009	SENSOR	SERPENTIN
		38159	SENSOR	A.A.
		38158	SENSOR	SERPENTIN
V8, 4.8 L	2007	36169	POLEA	A.A.
		38158	SENSOR	SERPENTIN
		38001	SENSOR	SERPENTIN
		38159	SENSOR	A.A.
		38009	SENSOR	SERPENTIN
V8, 5.3 L	2007	38001	SENSOR	SERPENTIN
		38009	SENSOR	SERPENTIN
		38158	SENSOR	SERPENTIN
		38159	SENSOR	A.A.
V8, 4.8 L	2006	36169	POLEA	A.A.
		38158	SENSOR	SERPENTIN
		38159	SENSOR	A.A.
		38001	SENSOR	SERPENTIN
		38009	SENSOR	SERPENTIN
V8, 5.3 L	2006	38001	SENSOR	SERPENTIN
		38158	SENSOR	SERPENTIN
		38159	SENSOR	A.A.
		38009	SENSOR	SERPENTIN
V8, 6.5 L Diesel	1995	38267	SENSOR PARA BANDA MICRO-V	

**TRAILBLAZER**

6 CIL. 4.2 L	2007	36101	POLEA	
		38006	SENSOR	
		38178	SENSOR	
		38018	SENSOR	
V8, 5.3 L	2007	38158	SENSOR	SERPENTIN
		38009	SENSOR	SERPENTIN
		38001	SENSOR	SERPENTIN
		38159	SENSOR	A.A.
6 CIL. 4.2 L	2006	36101	POLEA	
		38018	SENSOR	
		38006	SENSOR	
		38178	SENSOR	
V8, 5.3 L	2006	38159	SENSOR	A.A.
		38158	SENSOR	SERPENTIN
		38001	SENSOR	
		38009	SENSOR	
V8, 6.0 L	2006	38158	SENSOR	SERPENTIN
		38159	SENSOR	A.A.
		38009	SENSOR	SERPENTIN
		38001	SENSOR	SERPENTIN
6 CIL. 4.2 L	2005	36101	POLEA	
		38006	SENSOR	LOCA
		38018	SENSOR	
		38178	SENSOR	
V8, 5.3 L	2005	38009	SENSOR	LOCA
		38001	SENSOR	
		38159	SENSOR	
		38158	SENSOR	
6 CIL. 4.2 L	2004	36101	POLEA	
		38018	SENSOR	
		38178	SENSOR	
		38006	SENSOR	
6 CIL. 4.2 L	2003	36101	POLEA	
		38006	SENSOR	
		38018	SENSOR	
		38178	SENSOR	
V8, 5.3 L	2003	38158	SENSOR	SERPENTIN
		38001	SENSOR	
		38009	SENSOR	
		38159	SENSOR	
6 CIL. 4.2 L	2002	36101	POLEA	
		38178	SENSOR	
		38006	SENSOR	
		38018	SENSOR	

**TIGRA**

4 CIL. 1.6 L	2000	38200	SENSOR	
4 CIL. 1.6 L	1999	38200	SENSOR	

**TORNADO**

4 CIL. 1.8 L	2009	TPG-14004	SENSOR ARBOL DE LEVAS	
		TMV-14001	SENSOR MICRO-V	
4 CIL. 1.8 L	2008	TPG-14004	SENSOR ARBOL DE LEVAS	
		TMV-14001	SENSOR MICRO-V	
4 CIL. 1.8 L	2007	TPG-14004	SENSOR ARBOL DE LEVAS	
		TMV-14001	SENSOR MICRO-V	
4 CIL. 1.8 L	2006	TPG-14004	SENSOR ARBOL DE LEVAS	
		TMV-14001	SENSOR MICRO-V	
4 CIL. 1.8 L	2005	TPG-14004	SENSOR ARBOL DE LEVAS	
		TMV-14001	SENSOR MICRO-V	
4 CIL. 1.8 L	2004	TPG-14004	SENSOR ARBOL DE LEVAS	
		TMV-14001	SENSOR MICRO-V	
4 CIL. 1.8 L	2003	TPG-14004	SENSOR ARBOL DE LEVAS	
		TMV-14001	SENSOR MICRO-V	



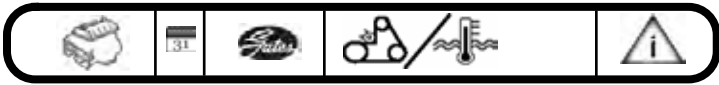

**TRAVERSE**

V6, 3.6 L	2011	38397	TENSOR	
V6, 3.6 L	2010	38397	TENSOR	

**UPLANDER**

V6, 3.9 L	2009	36201	POLEA	LISA SUP.
		38420	TENSOR	LISA INF.
		38006	TENSOR	RANURADA
		38009	TENSOR	RANURADA
V6, 3.9 L	2008	36201	POLEA	LISA SUP.
		38009	TENSOR	RANURADA
		38420	TENSOR	
		38006	TENSOR	LISA INF.
V6, 3.5 L	2007	38420	TENSOR	
		38006	TENSOR	
		38104	TENSOR	
		38009	TENSOR	
V6, 3.9 L	2007	38420	TENSOR	
		38006	TENSOR	LISO
		38009	TENSOR	CON CANALES
V6, 3.5 L	2006	38043	TENSOR	LISO
		38009	TENSOR	
		38006	TENSOR	LISA
		38104	TENSOR	
V6, 3.9 L	2006	38006	TENSOR	LISA
		38009	TENSOR	
V6, 3.5 L	2005	38104	TENSOR	
		38043	TENSOR	LISO
		38009	TENSOR	
		38006	TENSOR	LOCA

**ZAFIRA**

4 CIL. 2.0 L	2006	TCK1022M	KIT DE DISTRIBUCION	
		TCK1022M	KIT DE DISTRIBUCION	
		TPG-14001	TENSOR ARBOL DE LEVAS	
4 CIL. 2.4 L	2006	TCK305M	KIT DE DISTRIBUCION	
		TCK305M	KIT DE DISTRIBUCION	
		TPG-14002	TENSOR ARBOL DE LEVAS	
4 CIL. 2.0 L	2005	TCK1022M	KIT DE DISTRIBUCION	
		TCK1022M	KIT DE DISTRIBUCION	
		TPG-14001	TENSOR ARBOL DE LEVAS	
4 CIL. 2.4 L	2005	TCK305M	KIT DE DISTRIBUCION	
		TCK305M	KIT DE DISTRIBUCION	
		TPG-14002	TENSOR ARBOL DE LEVAS	
4 CIL. 2.0 L	2004	TCK1022M	KIT DE DISTRIBUCION	
		TCK1022M	KIT DE DISTRIBUCION	
		TPG-14001	TENSOR ARBOL DE LEVAS	
4 CIL. 2.4 L	2004	TCK305M	KIT DE DISTRIBUCION	
		TCK305M	KIT DE DISTRIBUCION	
		TPG-14002	TENSOR ARBOL DE LEVAS	
4 CIL. 1.8 L	2003	TCK1094	KIT DE DISTRIBUCION	
		TPG-14004	TENSOR ARBOL DE LEVAS	
		TMV-14001	TENSOR MICRO-V	
4 CIL. 1.8 L	2002	TCK1094	KIT DE DISTRIBUCION	
		TPG-14004	TENSOR ARBOL DE LEVAS	
		TMV-14001	TENSOR MICRO-V	
4 CIL. 1.8 L	2001	TCK1094	KIT DE DISTRIBUCION	
		TPG-14004	TENSOR ARBOL DE LEVAS	
		TMV-14001	TENSOR MICRO-V	
4 CIL. 1.8 L	2000	TCK1094	KIT DE DISTRIBUCION	
		TPG-14004	TENSOR ARBOL DE LEVAS	
		TMV-14001	TENSOR MICRO-V	

**VECTRA**

V6, 2.8 L	2008	38177	TENSOR	
V6, 2.8 L	2007	38177	TENSOR	
4 CIL. 2.2 L	2005	38177	TENSOR	
4 CIL. 2.2 L	2004	38177	TENSOR	
4 CIL. 2.2 L	2003	38177	TENSOR	

**VENTURE**

V6, 3.4 L	2005	38009	TENSOR	LISO
		38043	TENSOR	
		38104	TENSOR	
		38006	TENSOR	LOCA
V6, 3.4 L	2004	38043	TENSOR	LISO
		38009	TENSOR	
		38006	TENSOR	
		38104	TENSOR	
V6, 3.4 L	2003	38104	TENSOR	LISO
		38043	TENSOR	
		38009	TENSOR	
		38006	TENSOR	
V6, 3.4 L	2002	38043	TENSOR	LISO
		38104	TENSOR	
		38006	TENSOR	
		38009	TENSOR	
V6, 3.4 L	2001	38009	TENSOR	
		38006	TENSOR	
		38104	TENSOR	
V6, 3.4 L	2000	38006	TENSOR	
		38009	TENSOR	
		38104	TENSOR	
V6, 3.4 L	1999	38104	TENSOR	
		38009	TENSOR	
		38006	TENSOR	
V6, 3.4 L	1998	38105	TENSOR	
		38001	TENSOR	
V6, 3.4 L	1997	38105	TENSOR	
		38007	TENSOR	

**CHRYSLER**

**300**

V6, 2.7 L	2005	38323	TENSOR PARA BANDA MICRO-V	
-----------	------	-------	---------------------------	--

**300 C**

V6, 3.5 L	2009	TCK295A	KIT DE DISTRIBUCION	
		36313	POLEA	
		38082	TENSOR	
		38323	TENSOR	
		T43197	TENSOR- POLEA DE DIST.	
V8, 5.7 L	2009	38323	TENSOR	
		38018	TENSOR	
V6, 3.5 L	2008	TCK295A	KIT DE DISTRIBUCION	
		36313	POLEA	
		38323	TENSOR	
		38082	TENSOR	
		T43197	TENSOR- POLEA DE DIST.	
V8, 5.7 L	2008	38018	TENSOR	
		38323	TENSOR	
V6, 3.5 L	2007	TCK295A	KIT DE DISTRIBUCION	
		36313	POLEA	
		38323	TENSOR	
		38082	TENSOR	
		T43197	TENSOR- POLEA DE DIST.	
V8, 5.7 L	2007	38018	TENSOR	
		38323	TENSOR	
V6, 3.5 L	2006	38323	TENSOR	
V8, 5.7 L	2006	38323	TENSOR	
V8, 6.1 L	2006	38323	TENSOR	
V6, 3.5 L	2005	38323	TENSOR	
V8, 5.7 L	2005	38323	TENSOR	
V8, 6.1 L	2005	38323	TENSOR	

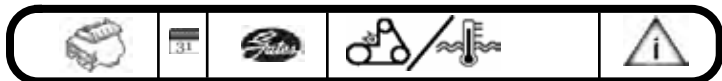

300M			
V6, 3.5 L	2004	38040	POLEA
		38042	POLEA
		38040	TENSOR
		38042	TENSOR
V6, 3.5 L	2003	T43148	TENSOR- POLEA DE DIST.
		38040	TENSOR
		38042	TENSOR
		T43148	TENSOR- POLEA DE DIST.
V6, 3.5 L	2002	TCK295	KIT DE DISTRIBUCION
		38042	TENSOR
		38040	TENSOR
		T41084	TENSOR- POLEA DE DIST.
		T41084	TENSOR- POLEA DE DIST.
V6, 3.5 L	2001	TCK295	KIT DE DISTRIBUCION
		38040	TENSOR
		38042	TENSOR
		T41084	TENSOR- POLEA DE DIST.
V6, 3.5 L	2000	TCK295	KIT DE DISTRIBUCION
		38042	TENSOR
		38020	TENSOR
		38040	TENSOR
		T41084	TENSOR- POLEA DE DIST.
V6, 3.5 L	1999	TCK295	KIT DE DISTRIBUCION
		38020	TENSOR
		38042	TENSOR
		38040	TENSOR
		T41084	TENSOR- POLEA DE DIST.

ASPEN			
V8, 5.7 L	2009	38382	TENSOR
		38058	TENSOR
V8, 5.7 L	2008	38382	TENSOR
		38058	TENSOR
V8, 5.7 L	2007	38382	TENSOR
		38058	TENSOR

CIRRUS			
4 CIL. 2.0 L	2000	TCK245	KIT DE DISTRIBUCION
		38042	TENSOR
		38020	TENSOR
		T43001	TENSOR- POLEA DE DIST.
		T43001	TENSOR- POLEA DE DIST.
		T41002	TENSOR- POLEA DE DIST.
		T43132	TENSOR- POLEA DE DIST.
		T41002	TENSOR- POLEA DE DIST.
4 CIL. 2.4 L	2000	38042	TENSOR
		38020	TENSOR
		T43005	TENSOR- POLEA DE DIST.
		T42121	TENSOR- POLEA DE DIST.
		T43005	TENSOR- POLEA DE DIST.
		T42121	TENSOR- POLEA DE DIST.
		T43008	TENSOR- POLEA DE DIST.
		T43008	TENSOR- POLEA DE DIST.
		T43131	TENSOR- POLEA DE DIST.
V6, 2.5 L	2000	TCK259	KIT DE DISTRIBUCION
		TCKWP259A	KIT DE DISTRIBUCION CON B.A.
		38020	TENSOR
		38042	TENSOR
		T42018	TENSOR- POLEA DE DIST.
		T42018	TENSOR- POLEA DE DIST.
		T41039	TENSOR- POLEA DE DIST.
		T41039	TENSOR- POLEA DE DIST.
4 CIL. 2.4 L	1999	38020	TENSOR
		38042	TENSOR
V6, 2.5 L	1999	TCK259	KIT DE DISTRIBUCION
		TCKWP259A	KIT DE DISTRIBUCION CON B.A.
		38020	TENSOR
		38042	TENSOR

V6, 2.5 L	1998	T42018	TENSOR- POLEA DE DIST.
		T41039	TENSOR- POLEA DE DIST.
		TCK259	KIT DE DISTRIBUCION
		TCKWP259A	KIT DE DISTRIBUCION CON B.A.
		38042	TENSOR
		38020	TENSOR
		T42018	TENSOR- POLEA DE DIST.
		T41039	TENSOR- POLEA DE DIST.
		38042	TENSOR
		38020	TENSOR
		T43005	TENSOR- POLEA DE DIST.
		T43008	TENSOR- POLEA DE DIST.
		T43131	TENSOR- POLEA DE DIST.
		T42121	TENSOR- POLEA DE DIST.
V6, 2.5 L	1997	TCK259	KIT DE DISTRIBUCION
		TCKWP259A	KIT DE DISTRIBUCION CON B.A.
		38042	TENSOR
		38020	TENSOR
		T41039	TENSOR- POLEA DE DIST.
		T42018	TENSOR- POLEA DE DIST.
		38042	TENSOR
		T43005	TENSOR- POLEA DE DIST.
		T42121	TENSOR- POLEA DE DIST.
V6, 2.5 L	1996	TCK259	KIT DE DISTRIBUCION
		TCKWP259A	KIT DE DISTRIBUCION CON B.A.
		38042	TENSOR
		38020	TENSOR
		T41039	TENSOR- POLEA DE DIST.
		T42018	TENSOR- POLEA DE DIST.
		38042	TENSOR
		T42121	TENSOR- POLEA DE DIST.
V6, 2.5 L	1995	TCK259	KIT DE DISTRIBUCION
		TCKWP259A	KIT DE DISTRIBUCION CON B.A.
		38042	TENSOR
		T41039	TENSOR- POLEA DE DIST.
		T42018	TENSOR- POLEA DE DIST.
		38042	TENSOR
		T42121	TENSOR- POLEA DE DIST.
V6, 2.5 L	1995	TCK259	KIT DE DISTRIBUCION
		TCKWP259A	KIT DE DISTRIBUCION CON B.A.
		38042	TENSOR
		T41039	TENSOR- POLEA DE DIST.
		T42018	TENSOR- POLEA DE DIST.

CONCORDE			
V6, 3.5 L	2004	T43148	TENSOR- POLEA DE DIST.
V6, 2.7 L	2003	36100	POLEA
V6, 3.5 L	2003	T43148	TENSOR- POLEA DE DIST.
V6, 3.5 L	2002	TCK295	KIT DE DISTRIBUCION
		38042	TENSOR
		38040	TENSOR
		T41084	TENSOR- POLEA DE DIST.
V6, 3.2 L	2001	TCK295	KIT DE DISTRIBUCION
		38020	TENSOR
		38040	TENSOR
		38042	TENSOR
		36100	POLEA
		38043	TENSOR
		38043	TENSOR
		TCK295	KIT DE DISTRIBUCION
		38020	TENSOR
		38040	TENSOR
		38042	TENSOR
		T41084	TENSOR- POLEA DE DIST.
V6, 2.7 L	1999	36100	POLEA
		38043	TENSOR
		38043	TENSOR
V6, 3.2 L	1999	TCK295	KIT DE DISTRIBUCION
		38040	TENSOR
		38020	TENSOR
		38042	TENSOR
		T41084	TENSOR- POLEA DE DIST.
V6, 2.7 L	1998	36100	POLEA
		38043	TENSOR
V6, 3.2 L	1998	TCK295	KIT DE DISTRIBUCION
		38040	TENSOR
		38042	TENSOR
		T41084	TENSOR- POLEA DE DIST.
V6, 3.5 L	1997	TCK255	KIT DE DISTRIBUCION

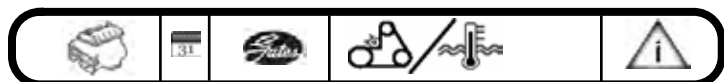

V6, 3.5 L	1997	38042	SENSOR	ALT. Y D.H.
		38040	SENSOR	A.A.
		38020	SENSOR	
		T41002	SENSOR- POLEA DE DIST.	
V6, 3.3 L	1996	38003	POLEA	
		38003	SENSOR	
V6, 3.5 L	1996	TCK255	KIT DE DISTRIBUCION	
		38040	SENSOR	A.A.
		38020	SENSOR	
		38042	SENSOR	ALT. Y D.H.
		T41002	SENSOR- POLEA DE DIST.	
V6, 3.3 L	1995	38003	SENSOR	
V6, 3.5 L	1995	TCK255	KIT DE DISTRIBUCION	
		38042	SENSOR	ALT. Y D.H.
		38040	SENSOR	A.A.
		38020	SENSOR	
		T41002	SENSOR- POLEA DE DIST.	
V6, 3.3 L	1994	38003	SENSOR	
V6, 3.5 L	1994	TCK219	KIT DE DISTRIBUCION	
		38003	SENSOR	
		38042	SENSOR	ALT.
		38020	SENSOR	
		38040	SENSOR	A.A.
		T41084	SENSOR- POLEA DE DIST.	
V6, 3.3 L	1993	38003	SENSOR	
V6, 3.5 L	1993	TCK219	KIT DE DISTRIBUCION	
		38003	SENSOR	
		38020	SENSOR	
		38040	SENSOR	A.A.
		38042	SENSOR	ALT.
		T41084	SENSOR- POLEA DE DIST.	



**GRAND VOYAGER**

V6, 3.0 L	2000	T41048	SENSOR- POLEA DE DIST.	
V6, 3.3 L	2000	TCK139	KIT DE DISTRIBUCION	
		38113	SENSOR	LISO
		38034	SENSOR	A.A. SOPORTE
		38042	SENSOR	LISO
		38113	SENSOR PARA BANDA MICRO-V	LISO
V6, 3.8 L	1999	38113	SENSOR	
		38020	SENSOR	
V6, 3.8 L	1998	38020	SENSOR	
		38113	SENSOR	
V6, 3.8 L	1997	38113	SENSOR	
		38020	SENSOR	
V6, 3.8 L	1996	38113	SENSOR	
		38020	SENSOR	
V6, 3.8 L	1995	38020	SENSOR	
		38113	SENSOR	
V6, 3.8 L	1994	38020	SENSOR	
		38113	SENSOR	

**INTREPID**

V6, 3.5 L (Canada)	2004	T43148	SENSOR- POLEA DE DIST.	HIDRAULICO
V6, 3.5 L (Canada)	2003	T43148	SENSOR- POLEA DE DIST.	HIDRAULICO

**LASER**

4 CIL. 2.2 L	1986	T41000	SENSOR- POLEA DE DIST.	
4 CIL. 2.2 L	1985	T41000	SENSOR- POLEA DE DIST.	
4 CIL. 2.2 L	1984	T41000	SENSOR- POLEA DE DIST.	

**CROSSFIRE**

V6, 3.2 L	2005	38082	POLEA	
		38174	SENSOR	
		38082	SENSOR	
		38174	SENSOR PARA BANDA MICRO-V	
V6, 3.2 L	2004	38174	SENSOR	
		38082	SENSOR	

**LEBARON**

V6, 3.0 L	1995	TCK139	KIT DE DISTRIBUCION	
		TCKWP139	KIT DE DISTRIBUCION CON B.A.	
		38042	SENSOR	SERPENTIN
		38122	SENSOR	SERPENTIN
		38003	SENSOR	A.A.
		T41048	SENSOR- POLEA DE DIST.	
		T41048	SENSOR- POLEA DE DIST.	
4 CIL. 2.5 L	1994	TCK153	KIT DE DISTRIBUCION	
		38003	SENSOR	
		T41001	SENSOR- POLEA DE DIST.	
V6, 3.0 L	1994	TCK139	KIT DE DISTRIBUCION	
		TCKWP139	KIT DE DISTRIBUCION CON B.A.	
		38122	SENSOR	SERPENTIN
		38042	SENSOR	SERPENTIN
		38003	SENSOR	A.A.
		T41048	SENSOR- POLEA DE DIST.	
		T41048	SENSOR- POLEA DE DIST.	
4 CIL. 2.5 L	1993	TCK153	KIT DE DISTRIBUCION	
		38003	SENSOR	
		T41001	SENSOR- POLEA DE DIST.	
V6, 3.0 L	1993	TCK139	KIT DE DISTRIBUCION	
		TCKWP139	KIT DE DISTRIBUCION CON B.A.	
		38003	SENSOR	A.A.
		38122	SENSOR	SERPENTIN
		38042	SENSOR	SERPENTIN
		T41048	SENSOR- POLEA DE DIST.	
		T41048	SENSOR- POLEA DE DIST.	
V6, 3.0 L	1992	TCKWP139	KIT DE DISTRIBUCION CON B.A.	
		T41048	SENSOR- POLEA DE DIST.	
V6, 3.0 L	1991	TCKWP139	KIT DE DISTRIBUCION CON B.A.	
V6, 3.0 L	1990	TCKWP139	KIT DE DISTRIBUCION CON B.A.	
4 CIL. 2.2 L	1988	T41000	SENSOR- POLEA DE DIST.	
4 CIL. 2.2 L	1987	T41000	SENSOR- POLEA DE DIST.	
4 CIL. 2.2 L	1986	T41000	SENSOR- POLEA DE DIST.	
4 CIL. 2.2 L	1985	T41000	SENSOR- POLEA DE DIST.	
4 CIL. 2.2 L	1984	T41000	SENSOR- POLEA DE DIST.	
4 CIL. 2.2 L	1983	T41000	SENSOR- POLEA DE DIST.	
4 CIL. 2.2 L	1982	T41000	SENSOR- POLEA DE DIST.	

**DAYTONA**

4 CIL. 2.5 L (Canada)	1993	T41001	SENSOR- POLEA DE DIST.	
V6, 3.0 L	1993	38122	SENSOR PARA BANDA MICRO-V	SERP. CANADA
V6, 3.0 L (Canada)	1993	T41048	SENSOR- POLEA DE DIST.	
4 CIL. 2.2 L	1992	T41001	SENSOR- POLEA DE DIST.	CANADA
4 CIL. 2.2 L (Canada)	1992	T41001	SENSOR- POLEA DE DIST.	
4 CIL. 2.5 L (Canada)	1992	T41001	SENSOR- POLEA DE DIST.	
V6, 3.0 L (Canada)	1992	T41048	SENSOR- POLEA DE DIST.	
V6, 3.0 L	1990	38124	SENSOR PARA BANDA MICRO-V	SERP. CANADA
4 CIL. 2.2 L (Canada)	1988	T41000	SENSOR- POLEA DE DIST.	
4 CIL. 2.2 L (Canada)	1987	T41000	SENSOR- POLEA DE DIST.	
4 CIL. 2.2 L (Canada)	1986	T41000	SENSOR- POLEA DE DIST.	
4 CIL. 2.2 L (Canada)	1985	T41000	SENSOR- POLEA DE DIST.	

**E CLASS**

4 CIL. 2.2 L	1984	T41000	SENSOR- POLEA DE DIST.	
4 CIL. 2.2 L	1983	T41000	SENSOR- POLEA DE DIST.	

**EXECUTIVE**

4 CIL. 2.2 L (Canada)	1986	T41000	SENSOR- POLEA DE DIST.	
-----------------------	------	--------	------------------------	--

**FIFTH AVENUE**

V8, 5.2 L	1989	36103	POLEA	POLEA LOCA
V8, 5.2 L	1988	36103	POLEA	POLEA LOCA
V8, 5.2 L	1987	36103	POLEA	POLEA LOCA
V8, 5.2 L	1986	36103	POLEA	POLEA LOCA
V8, 5.2 L	1985	36103	POLEA	POLEA LOCA

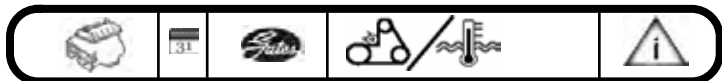

**NEON**

4 CIL. 2.0 L (Canada)	2002	T43132	TENSOR- POLEA DE DIST.	
4 CIL. 2.0 L (Canada)	2001	T43132	TENSOR- POLEA DE DIST.	
4 CIL. 2.0 L (Canada)	2000	T43132	TENSOR- POLEA DE DIST.	

**NEW YORKER**

V6, 3.5 L	1996	TCK255	KIT DE DISTRIBUCION	
		38042	TENSOR	ALT. Y D.H.
		38040	TENSOR	A.A.
		T41002	TENSOR- POLEA DE DIST.	
V6, 3.5 L	1995	TCK255	KIT DE DISTRIBUCION	
		38042	TENSOR	ALT. Y D.H.
		38040	TENSOR	A.A.
		T41002	TENSOR- POLEA DE DIST.	
V6, 3.5 L	1994	TCK219	KIT DE DISTRIBUCION	
		38042	TENSOR	ALT.
		38040	TENSOR	A.A.
		T41084	TENSOR- POLEA DE DIST.	
V6, 3.3 L	1993	38113	TENSOR	
		38042	TENSOR	
		38020	TENSOR	
V6, 3.8 L	1993	38042	TENSOR	
		38113	TENSOR	
4 CIL. 2.2 L	1988	T41000	TENSOR- POLEA DE DIST.	
4 CIL. 2.2 L	1987	T41000	TENSOR- POLEA DE DIST.	
4 CIL. 2.2 L	1986	T41000	TENSOR- POLEA DE DIST.	
4 CIL. 2.2 L	1985	T41000	TENSOR- POLEA DE DIST.	
4 CIL. 2.2 L	1984	T41000	TENSOR- POLEA DE DIST.	
4 CIL. 2.2 L	1983	T41000	TENSOR- POLEA DE DIST.	

**PACIFICA**

V6, 4.0 L	2008	38417	TENSOR	
		38417	TENSOR PARA BANDA MICRO-V	
V6, 4.0 L	2007	38417	TENSOR	
V6, 3.5 L	2006	38323	TENSOR	
V6, 3.5 L	2005	38323	TENSOR	
V6, 3.5 L	2004	38323	TENSOR	
		T43148	TENSOR- POLEA DE DIST.	HIDRAULICO

**PT CRUISER**

4 CIL. 2.4 L	2010	TCKWP265	KIT DE DISTRIBUCION CON B.A.	
		TCKWP265A	KIT DE DISTRIBUCION CON B.A.	
		36156	POLEA	
		38176	TENSOR	
		T43008	TENSOR- POLEA DE DIST.	SIN SOPORTE
		T42121	TENSOR- POLEA DE DIST.	
		T43131	TENSOR- POLEA DE DIST.	CON SOPORTE
4 CIL. 2.4 L	2009	TCKWP265	KIT DE DISTRIBUCION CON B.A.	
		TCKWP265A	KIT DE DISTRIBUCION CON B.A.	
		36156	POLEA	
		38176	TENSOR	
		T43131	TENSOR- POLEA DE DIST.	CON SOPORTE
		T43008	TENSOR- POLEA DE DIST.	SIN SOPORTE
		T42121	TENSOR- POLEA DE DIST.	
4 CIL. 2.4 L	2008	TCKWP265	KIT DE DISTRIBUCION CON B.A.	
		TCKWP265A	KIT DE DISTRIBUCION CON B.A.	
		36156	POLEA	
		38176	TENSOR	
		T43131	TENSOR- POLEA DE DIST.	
		T43131	TENSOR- POLEA DE DIST.	CON SOPORTE
		T43008	TENSOR- POLEA DE DIST.	SIN SOPORTE
		T42121	TENSOR- POLEA DE DIST.	
4 CIL. 2.4 L	2007	TCKWP265A	KIT DE DISTRIBUCION CON B.A.	
		TCKWP265	KIT DE DISTRIBUCION CON B.A.	
		38176	TENSOR	
		38176	TENSOR PARA BANDA MICRO-V	
		T43131	TENSOR- POLEA DE DIST.	
4 CIL. 2.4 L	2006	TCKWP265	KIT DE DISTRIBUCION CON B.A.	
		TCKWP265A	KIT DE DISTRIBUCION CON B.A.	

**SEBRING**

4 CIL. 2.4 L	2006	T43131	TENSOR- POLEA DE DIST.	
4 CIL. 2.4 L	2005	T43008	TENSOR- POLEA DE DIST.	
		T43131	TENSOR- POLEA DE DIST.	
		T42121	TENSOR- POLEA DE DIST.	
V6, 3.0 L	2005	T41039	TENSOR- POLEA DE DIST.	
		T42018	TENSOR- POLEA DE DIST.	
4 CIL. 2.4 L	2004	T42017	TENSOR- POLEA DE DIST.	
		T42121	TENSOR- POLEA DE DIST.	
		T43008	TENSOR- POLEA DE DIST.	
		T43131	TENSOR- POLEA DE DIST.	
		T41054	TENSOR- POLEA DE DIST.	
		T42017	TENSOR- POLEA DE DIST.	
		T41038	TENSOR- POLEA DE DIST.	
		T41054	TENSOR- POLEA DE DIST.	
		T41038	TENSOR- POLEA DE DIST.	
V6, 3.0 L	2004	TCK259	KIT DE DISTRIBUCION	
		T41039	TENSOR- POLEA DE DIST.	
		T42018	TENSOR- POLEA DE DIST.	
4 CIL. 2.4 L	2003	T42121	TENSOR- POLEA DE DIST.	
		T43008	TENSOR- POLEA DE DIST.	
		T42017	TENSOR- POLEA DE DIST.	
		T41038	TENSOR- POLEA DE DIST.	
		T43131	TENSOR- POLEA DE DIST.	
		T41054	TENSOR- POLEA DE DIST.	
V6, 3.0 L	2003	TCK259	KIT DE DISTRIBUCION	
		T42018	TENSOR- POLEA DE DIST.	
		T41039	TENSOR- POLEA DE DIST.	
4 CIL. 2.4 L	2002	T41054	TENSOR- POLEA DE DIST.	
		T43005	TENSOR- POLEA DE DIST.	
		T42121	TENSOR- POLEA DE DIST.	
		T43131	TENSOR- POLEA DE DIST.	
		T42017	TENSOR- POLEA DE DIST.	
		T41038	TENSOR- POLEA DE DIST.	
		T43008	TENSOR- POLEA DE DIST.	
V6, 3.0 L	2002	TCK259	KIT DE DISTRIBUCION	
		T41039	TENSOR- POLEA DE DIST.	
		T42018	TENSOR- POLEA DE DIST.	
4 CIL. 2.4 L	2001	T43005	TENSOR- POLEA DE DIST.	
		T43131	TENSOR- POLEA DE DIST.	

4 CIL. 2.4 L	2001	T43008	SENSOR- POLEA DE DIST.			38417	SENSOR	
		T41054	SENSOR- POLEA DE DIST.			38018	SENSOR	
		T42121	SENSOR- POLEA DE DIST.			T43197	SENSOR- POLEA DE DIST.	
		T42017	SENSOR- POLEA DE DIST.	V6, 3.8 L	2007	38018	SENSOR	
		T41038	SENSOR- POLEA DE DIST.			38043	SENSOR	
V6, 3.0 L	2001	TCK259	KIT DE DISTRIBUCION			38185	SENSOR	
		T41039	SENSOR- POLEA DE DIST.			38185	SENSOR PARA BANDA MICRO-V	
		T42018	SENSOR- POLEA DE DIST.	V6, 3.8 L	2006	38043	SENSOR	
V6, 2.5 L	2000	TCK259	KIT DE DISTRIBUCION			38185	SENSOR	
		38042	SENSOR			38018	SENSOR	
		T41039	SENSOR- POLEA DE DIST.	V6, 3.8 L	2005	38185	SENSOR	
		T42018	SENSOR- POLEA DE DIST.			38018	SENSOR	
4 CIL. 2.0 L	1999	TCKWP246	KIT DE DISTRIBUCION CON B.A.			38043	SENSOR	
		T43132	SENSOR- POLEA DE DIST.	V6, 3.8 L	2003	38043	SENSOR	
4 CIL. 2.4 L	1999	38042	SENSOR	V6, 3.8 L	2002	38043	SENSOR	
		T43008	SENSOR- POLEA DE DIST.	V6, 3.8 L	2001	38043	SENSOR	
		T43131	SENSOR- POLEA DE DIST.	V6, 3.8 L	2000	38113	SENSOR	
		T42121	SENSOR- POLEA DE DIST.	V6, 3.8 L	1999	38113	SENSOR	
		T43005	SENSOR- POLEA DE DIST.	V6, 3.8 L	1995	38113	SENSOR	
V6, 2.5 L	1999	TCK259	KIT DE DISTRIBUCION	4 CIL. 2.2 L	1988	T41000	SENSOR- POLEA DE DIST.	
		38042	SENSOR	4 CIL. 2.2 L	1987	T41000	SENSOR- POLEA DE DIST.	
		T42018	SENSOR- POLEA DE DIST.	4 CIL. 2.2 L	1986	T41000	SENSOR- POLEA DE DIST.	
		T41039	SENSOR- POLEA DE DIST.	4 CIL. 2.2 L	1985	T41000	SENSOR- POLEA DE DIST.	
4 CIL. 2.0 L	1998	TCKWP246	KIT DE DISTRIBUCION CON B.A.	4 CIL. 2.2 L	1984	T41000	SENSOR- POLEA DE DIST.	
		T43132	SENSOR- POLEA DE DIST.	4 CIL. 2.2 L	1983	T41000	SENSOR- POLEA DE DIST.	
4 CIL. 2.4 L	1998	38042	SENSOR	4 CIL. 2.2 L	1982	T41000	SENSOR- POLEA DE DIST.	
		T43005	SENSOR- POLEA DE DIST.					
		T43131	SENSOR- POLEA DE DIST.					
		T42121	SENSOR- POLEA DE DIST.					
		T43008	SENSOR- POLEA DE DIST.					
V6, 2.5 L	1998	TCK259	KIT DE DISTRIBUCION	V6, 3.3 L	2007	38018	SENSOR	
		38042	SENSOR			38185	SENSOR	
		T41039	SENSOR- POLEA DE DIST.	V6, 3.3 L	2006	38043	SENSOR	
		T42018	SENSOR- POLEA DE DIST.			38185	SENSOR	
4 CIL. 2.0 L	1997	TCKWP246	KIT DE DISTRIBUCION CON B.A.			38018	SENSOR	
		T43132	SENSOR- POLEA DE DIST.	V6, 3.3 L	2005	38043	SENSOR	
4 CIL. 2.4 L	1997	38020	SENSOR			38018	SENSOR	
		38042	SENSOR	V6, 3.3 L	2004	38043	SENSOR	
		T43131	SENSOR- POLEA DE DIST.			38018	SENSOR	
		T42121	SENSOR- POLEA DE DIST.			38185	SENSOR	
		T43008	SENSOR- POLEA DE DIST.	4 CIL. 2.4 L	2003	T43131	SENSOR- POLEA DE DIST.	
		T43005	SENSOR- POLEA DE DIST.	V6, 3.3 L	2003	38018	SENSOR	
V6, 2.5 L	1997	TCK259	KIT DE DISTRIBUCION			38043	SENSOR	
		38042	SENSOR			38043	SENSOR	
		T41039	SENSOR- POLEA DE DIST.			38185	SENSOR	
		T42018	SENSOR- POLEA DE DIST.	4 CIL. 2.4 L	2002	TCKWP265B	KIT DE DISTRIBUCION CON B.A.	
4 CIL. 2.0 L	1996	TCKWP246	KIT DE DISTRIBUCION CON B.A.			T43131	SENSOR- POLEA DE DIST.	
		T43132	SENSOR- POLEA DE DIST.	V6, 3.3 L	2002	38043	SENSOR	
4 CIL. 2.4 L	1996	38042	SENSOR			38018	SENSOR	
		38020	SENSOR			38185	SENSOR	
		T42121	SENSOR- POLEA DE DIST.			38043	SENSOR	
		T43005	SENSOR- POLEA DE DIST.	4 CIL. 2.4 L	2001	TCKWP265B	KIT DE DISTRIBUCION CON B.A.	
V6, 2.5 L	1996	TCK259	KIT DE DISTRIBUCION			T43131	SENSOR- POLEA DE DIST.	
		38042	SENSOR	V6, 3.0 L	2001	TCK139	KIT DE DISTRIBUCION	
		T42018	SENSOR- POLEA DE DIST.	V6, 3.3 L	2001	38185	SENSOR	
		T41039	SENSOR- POLEA DE DIST.			38018	SENSOR	
4 CIL. 2.0 L	1995	TCKWP246	KIT DE DISTRIBUCION CON B.A.			38043	SENSOR	
				4 CIL. 2.4 L	2000	TCKWP265B	KIT DE DISTRIBUCION CON B.A.	
						T43131	SENSOR- POLEA DE DIST.	
V6, 4.0 L	2010	TCK295A	KIT DE DISTRIBUCION	V6, 3.0 L	2000	TCK139	KIT DE DISTRIBUCION	LISO
		36313	POLEA			38042	SENSOR	CON CANALES
		38018	SENSOR			38009	SENSOR	LISO
		38417	SENSOR			38122	SENSOR	
		T43197	SENSOR- POLEA DE DIST.			T41048	SENSOR- POLEA DE DIST.	
V6, 4.0 L	2009	TCK295A	KIT DE DISTRIBUCION	V6, 3.3 L	2000	T41048	SENSOR- POLEA DE DIST.	
		36313	POLEA			38001	SENSOR	
		38018	SENSOR			38042	SENSOR	LISO
		38417	SENSOR			38020	SENSOR	
		T43197	SENSOR- POLEA DE DIST.			38034	SENSOR	A.A. SOPORTE
V6, 4.0 L	2008	TCK295A	KIT DE DISTRIBUCION			38113	SENSOR	
		36313	POLEA	4 CIL. 2.4 L	1999	TCKWP265B	KIT DE DISTRIBUCION CON B.A.	
		38417	SENSOR	V6, 3.3 L	1999	38020	SENSOR	

**VOYAGER**

**TOWN & COUNTRY**

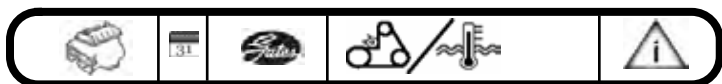

V6, 3.3 L	1999	38113	TENSOR
V6, 3.8 L	1999	38113	TENSOR
4 CIL. 2.4 L	1998	TCKWP265B	KIT DE DISTRIBUCION CON B.A.
V6, 3.0 L	1998	TCK139	KIT DE DISTRIBUCION
V6, 3.3 L	1998	38020	TENSOR
		38113	TENSOR
4 CIL. 2.4 L	1997	TCKWP265B	KIT DE DISTRIBUCION CON B.A.
V6, 3.0 L	1997	TCK139	KIT DE DISTRIBUCION
V6, 3.3 L	1997	38113	TENSOR
		38020	TENSOR
V6, 3.0 L	1996	TCK139	KIT DE DISTRIBUCION
V6, 3.3 L	1996	38020	TENSOR
		38113	TENSOR

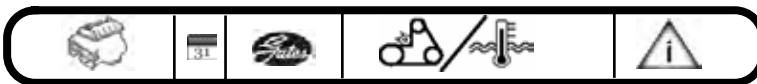

**600**

4 CIL. 2.2 L	1988	T41000	TENSOR- POLEA DE DIST.
4 CIL. 2.2 L	1987	T41000	TENSOR- POLEA DE DIST.
4 CIL. 2.2 L	1986	T41000	TENSOR- POLEA DE DIST.
4 CIL. 2.2 L	1985	T41000	TENSOR- POLEA DE DIST.
4 CIL. 2.2 L	1984	T41000	TENSOR- POLEA DE DIST.
4 CIL. 2.2 L	1983	T41000	TENSOR- POLEA DE DIST.

**ADVENTURER**

V6, 3.3 L	2000	38042	TENSOR	C/POLEA CERCA DEL ALT.
		38113	TENSOR	
V6, 3.3 L	1999	38113	TENSOR	C/POLEA CERCA DEL ALT.
		38042	TENSOR	C/POLEA CERCA DEL ALT.
V6, 3.3 L	1998	38042	TENSOR	C/POLEA CERCA DEL ALT.
		38113	TENSOR	
V6, 3.3 L	1997	38113	TENSOR	C/POLEA CERCA DEL ALT.
		38042	TENSOR	C/POLEA CERCA DEL ALT.
V6, 3.3 L	1996	38113	TENSOR	C/POLEA CERCA DEL ALT.
		38042	TENSOR	C/POLEA CERCA DEL ALT.
V6, 3.3 L	1995	38042	TENSOR	C/POLEA CERCA DEL ALT.
		38113	TENSOR	
V6, 3.3 L	1994	38113	TENSOR	
		38042	TENSOR	
V6, 3.3 L	1993	38113	TENSOR	
		38042	TENSOR	

**DAEWOO**

**LEGANZA**

4 CIL. 2.2 L	2002	38154	TENSOR PARA BANDA MICRO-V
4 CIL. 2.2 L	2001	38154	TENSOR PARA BANDA MICRO-V
4 CIL. 2.2 L	2000	38154	TENSOR PARA BANDA MICRO-V
4 CIL. 2.2 L	1999	38154	TENSOR PARA BANDA MICRO-V

**NUBIRA**

4 CIL. 2.0 L	2002	38154	TENSOR PARA BANDA MICRO-V
4 CIL. 2.0 L	2001	38154	TENSOR PARA BANDA MICRO-V
4 CIL. 2.0 L	2000	38154	TENSOR PARA BANDA MICRO-V
4 CIL. 2.0 L	1999	38154	TENSOR PARA BANDA MICRO-V

**DAIHATSU**

**CHARADE**

3 CIL. 1.0 L	1992	T41003	TENSOR- POLEA DE DIST.
4 CIL. 1.3 L	1992	T41004	TENSOR- POLEA DE DIST.
3 CIL. 1.0 L	1991	T41003	TENSOR- POLEA DE DIST.
4 CIL. 1.3 L	1991	T41004	TENSOR- POLEA DE DIST.
3 CIL. 1.0 L	1990	T41003	TENSOR- POLEA DE DIST.
4 CIL. 1.3 L	1990	T41004	TENSOR- POLEA DE DIST.
3 CIL. 1.0 L	1989	T41003	TENSOR- POLEA DE DIST.
4 CIL. 1.3 L	1989	T41004	TENSOR- POLEA DE DIST.
3 CIL. 1.0 L	1988	T41003	TENSOR- POLEA DE DIST.

**ROCKY**

4 CIL. 1.6 L	1992	T41004	TENSOR- POLEA DE DIST.
4 CIL. 1.6 L	1991	T41004	TENSOR- POLEA DE DIST.
4 CIL. 1.6 L	1990	T41004	TENSOR- POLEA DE DIST.

**DODGE**

**2000 GTX**

4 CIL. 2.0 L (Canada)	1990	T41053	TENSOR- POLEA DE DIST.	BALANCIN
		T41043	TENSOR- POLEA DE DIST.	
4 CIL. 2.0 L (Canada)	1989	T41053	TENSOR- POLEA DE DIST.	BALANCIN
		T41047	TENSOR- POLEA DE DIST.	BALANCIN
		T41043	TENSOR- POLEA DE DIST.	
		T41046	TENSOR- POLEA DE DIST.	

**400**

4 CIL. 2.2 L	1983	T41000	TENSOR- POLEA DE DIST.
4 CIL. 2.2 L	1982	T41000	TENSOR- POLEA DE DIST.

**AVENGER**

4 CIL. 2.0 L	2009	37018P	POLEA DECOPLADORA
		39053	TENSOR
4 CIL. 2.4 L	2009	37018P	POLEA DECOPLADORA
		39053	TENSOR
4 CIL. 2.0 L	2008	37018P	POLEA DECOPLADORA
		39053	TENSOR
4 CIL. 2.4 L	2008	37018P	POLEA DECOPLADORA
		39053	TENSOR
4 CIL. 2.0 L	2007	37018P	POLEA DECOPLADORA
		39053	TENSOR
4 CIL. 2.4 L	2007	37018P	POLEA DECOPLADORA
		39053	TENSOR
4 CIL. 2.0 L	1999	T43132	TENSOR- POLEA DE DIST.
4 CIL. 2.0 L	1998	T43132	TENSOR- POLEA DE DIST.
4 CIL. 2.0 L	1997	T43132	TENSOR- POLEA DE DIST.
4 CIL. 2.0 L	1996	T43132	TENSOR- POLEA DE DIST.

**B SERIES VAN**

V6, 3.9 L	2003	38016	POLEA	
		38033	POLEA	
		38116	TENSOR PARA BANDA MICRO-V	
V8, 5.9 L	1992	36103	POLEA	POLEA LOCA
V6, 3.9 L	1991	36103	POLEA	POLEA LOCA
V8, 5.2 L	1991	36103	POLEA	POLEA LOCA
V8, 5.9 L	1991	36103	POLEA	POLEA LOCA
V6, 3.9 L	1990	36103	POLEA	POLEA LOCA
V8, 5.2 L	1990	36103	POLEA	POLEA LOCA
V8, 5.9 L	1990	36103	POLEA	POLEA LOCA
V6, 3.9 L	1989	36103	POLEA	POLEA LOCA
V8, 5.2 L	1989	36103	POLEA	POLEA LOCA
V8, 5.9 L	1989	36103	POLEA	POLEA LOCA
V6, 3.9 L	1988	36103	POLEA	POLEA LOCA
V8, 5.2 L	1988	36103	POLEA	POLEA LOCA
V8, 5.9 L	1988	36103	POLEA	POLEA LOCA
6 CIL. 3.7 L	1987	36103	POLEA	POLEA LOCA
V8, 5.2 L	1987	36103	POLEA	POLEA LOCA
V8, 5.9 L	1987	36103	POLEA	POLEA LOCA
V8, 5.2 L	1986	36103	POLEA	POLEA LOCA
V8, 5.9 L	1986	36103	POLEA	POLEA LOCA

**CALIBER**

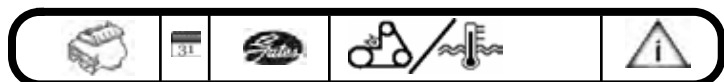

4 CIL. 2.4 L	2009	37018P 39053	POLEA DECOPLADORA TENSOR
4 CIL. 2.4 L	2008	37018P 39053	POLEA DECOPLADORA TENSOR
4 CIL. 2.4 L	2007	37018P 39053	POLEA DECOPLADORA TENSOR

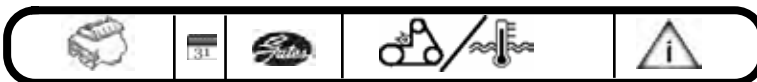

V6. 3.0 L	1997	T43008 T42121 T43005 TCKWP139	TENSOR- POLEA DE DIST. TENSOR- POLEA DE DIST. TENSOR- POLEA DE DIST. KIT DE DISTRIBUCION CON B.A.
V6. 3.3 L	1997	T41048 38113 38034 38042	TENSOR- POLEA DE DIST. TENSOR TENSOR TENSOR
V6. 3.0 L	1996	TCKWP139 T41048	KIT DE DISTRIBUCION CON B.A. TENSOR- POLEA DE DIST.
V6. 3.3 L	1996	38034 38042 38113	TENSOR TENSOR TENSOR
4 CIL. 2.5 L	1995	TCK153 38003	KIT DE DISTRIBUCION TENSOR
V6. 3.0 L	1995	T41001 TCK139 TCKWP139	TENSOR- POLEA DE DIST. KIT DE DISTRIBUCION KIT DE DISTRIBUCION CON B.A.
V6. 3.3 L	1995	38122 38042 38003	TENSOR TENSOR TENSOR
V6. 3.3 L	1995	T41048 T41048 38034 38113 38042	TENSOR- POLEA DE DIST. TENSOR- POLEA DE DIST. TENSOR TENSOR TENSOR
4 CIL. 2.5 L	1994	T41001	TENSOR- POLEA DE DIST.
V6. 3.0 L	1994	TCK139 TCKWP139	KIT DE DISTRIBUCION KIT DE DISTRIBUCION CON B.A.
4 CIL. 2.5 L	1993	T41048 T41001	TENSOR- POLEA DE DIST. TENSOR- POLEA DE DIST.
V6. 3.0 L	1993	TCKWP139 T41048	KIT DE DISTRIBUCION CON B.A. TENSOR- POLEA DE DIST.
4 CIL. 2.5 L	1992	T41001	TENSOR- POLEA DE DIST.
V6. 3.0 L	1992	TCKWP139 T41048	KIT DE DISTRIBUCION CON B.A. TENSOR- POLEA DE DIST.
V6. 3.0 L	1991	TCKWP139	KIT DE DISTRIBUCION CON B.A.
V6. 3.0 L	1990	TCKWP139	KIT DE DISTRIBUCION CON B.A.
V6. 3.0 L	1989	TCKWP139	KIT DE DISTRIBUCION CON B.A.
V6. 3.0 L	1988	TCKWP139	KIT DE DISTRIBUCION CON B.A.
4 CIL. 2.2 L	1987	T41000	TENSOR- POLEA DE DIST.
V6. 3.0 L	1987	TCKWP139	KIT DE DISTRIBUCION CON B.A.
4 CIL. 2.2 L	1986	T41000	TENSOR- POLEA DE DIST.
4 CIL. 2.2 L	1985	T41000	TENSOR- POLEA DE DIST.
4 CIL. 2.2 L	1984	T41000	TENSOR- POLEA DE DIST.

**CARAVAN**

4 CIL. 2.4 L	2007	TCKWP265A TCKWP265 T43131	KIT DE DISTRIBUCION CON B.A. KIT DE DISTRIBUCION CON B.A. TENSOR- POLEA DE DIST.
V6. 3.3 L	2007	38043 38185 38018	TENSOR TENSOR TENSOR
4 CIL. 2.4 L	2006	TCKWP265A TCKWP265 T43131	KIT DE DISTRIBUCION CON B.A. KIT DE DISTRIBUCION CON B.A. TENSOR- POLEA DE DIST.
V6. 3.3 L	2006	38043 38185 38018	TENSOR TENSOR TENSOR
4 CIL. 2.4 L	2005	TCKWP265 TCKWP265A T43131	KIT DE DISTRIBUCION CON B.A. KIT DE DISTRIBUCION CON B.A. TENSOR- POLEA DE DIST.
V6. 3.3 L	2005	38185 38043 38018	TENSOR TENSOR TENSOR
4 CIL. 2.4 L	2004	TCKWP265 TCKWP265A T43131	KIT DE DISTRIBUCION CON B.A. KIT DE DISTRIBUCION CON B.A. TENSOR- POLEA DE DIST.
V6. 3.3 L	2004	38018 38185 38043	TENSOR TENSOR TENSOR
4 CIL. 2.4 L	2003	TCKWP265A TCKWP265 T43131	KIT DE DISTRIBUCION CON B.A. KIT DE DISTRIBUCION CON B.A. TENSOR- POLEA DE DIST.
V6. 3.3 L FLEX	2003	38043	TENSOR
4 CIL. 2.4 L	2002	TCKWP265B T43008 T43131 T43005 T42121	KIT DE DISTRIBUCION CON B.A. TENSOR- POLEA DE DIST. TENSOR- POLEA DE DIST. TENSOR- POLEA DE DIST. TENSOR- POLEA DE DIST.
V6. 3.3 L	2002	38018 38043 38185 38043	TENSOR TENSOR TENSOR TENSOR
V6. 3.3 L FLEX	2002	38043	TENSOR
4 CIL. 2.4 L	2001	TCKWP265B T43131	KIT DE DISTRIBUCION CON B.A. TENSOR- POLEA DE DIST.
V6. 3.3 L FLEX	2001	38043	TENSOR
4 CIL. 2.4 L	2000	TCKWP265B T43131	KIT DE DISTRIBUCION CON B.A. TENSOR- POLEA DE DIST.
V6. 3.0 L	2000	TCKWP139 T41048	KIT DE DISTRIBUCION CON B.A. TENSOR- POLEA DE DIST.
V6. 3.3 L	2000	38042 38113 38034	TENSOR TENSOR TENSOR
4 CIL. 2.4 L	1999	TCKWP265B T43131	KIT DE DISTRIBUCION CON B.A. TENSOR- POLEA DE DIST.
V6. 3.0 L	1999	TCKWP139 T41048	KIT DE DISTRIBUCION CON B.A. TENSOR- POLEA DE DIST.
V6. 3.3 L	1999	38034 38113 38042	TENSOR TENSOR TENSOR
4 CIL. 2.4 L	1998	TCKWP265B T43131	KIT DE DISTRIBUCION CON B.A. TENSOR- POLEA DE DIST.
V6. 3.0 L	1998	TCKWP139 T41048	KIT DE DISTRIBUCION CON B.A. TENSOR- POLEA DE DIST.
V6. 3.3 L	1998	38113 38034 38042	TENSOR TENSOR TENSOR
4 CIL. 2.4 L	1997	TCKWP265B 38042 T43131	KIT DE DISTRIBUCION CON B.A. TENSOR TENSOR- POLEA DE DIST.

**COLT**

4 CIL. 1.5 L (Canada)	1995	T41051	TENSOR- POLEA DE DIST.
4 CIL. 1.5 L	1994	T41051	TENSOR- POLEA DE DIST.
4 CIL. 1.8 L	1994	T41052	TENSOR- POLEA DE DIST.
4 CIL. 1.5 L	1993	T41051	TENSOR- POLEA DE DIST.
4 CIL. 1.8 L	1993	T41052	TENSOR- POLEA DE DIST.
4 CIL. 1.5 L	1992	T41051	TENSOR- POLEA DE DIST.
4 CIL. 1.5 L	1991	T41042	TENSOR- POLEA DE DIST.
4 CIL. 1.5 L	1990	T41042	TENSOR- POLEA DE DIST.
4 CIL. 1.6 L	1990	T41046	TENSOR- POLEA DE DIST.
4 CIL. 1.8 L	1990	T41056	TENSOR- POLEA DE DIST.
4 CIL. 1.5 L	1989	T41042	TENSOR- POLEA DE DIST.
4 CIL. 1.6 L	1989	T41046	TENSOR- POLEA DE DIST.
4 CIL. 1.8 L	1989	T41056	TENSOR- POLEA DE DIST.
4 CIL. 1.5 L	1988	T41042	TENSOR- POLEA DE DIST.
4 CIL. 1.6 L	1988	T41056	TENSOR- POLEA DE DIST.
4 CIL. 1.5 L	1987	T41042	TENSOR- POLEA DE DIST.
4 CIL. 1.6 L	1987	T41055	TENSOR- POLEA DE DIST.
4 CIL. 1.5 L	1986	T41056	TENSOR- POLEA DE DIST.
4 CIL. 1.5 L	1986	T41042	TENSOR- POLEA DE DIST.
4 CIL. 2.0 L	1986	T41053	TENSOR- POLEA DE DIST.
4 CIL. 1.5 L	1985	T41043 T41042	TENSOR- POLEA DE DIST. TENSOR- POLEA DE DIST.
4 CIL. 2.0 L	1985	T41053	TENSOR- POLEA DE DIST.

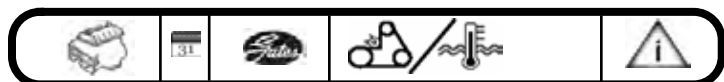

4 CIL. 2.0 L	1985	T41043	TENSOR- POLEA DE DIST.	
4 CIL. 1.4 L	1984	T41042	TENSOR- POLEA DE DIST.	
4 CIL. 1.4 L	1983	T41042	TENSOR- POLEA DE DIST.	
4 CIL. 1.6 L	1983	T41055	TENSOR- POLEA DE DIST.	
4 CIL. 1.4 L	1982	T41042	TENSOR- POLEA DE DIST.	
4 CIL. 1.6 L	1982	T41055	TENSOR- POLEA DE DIST.	

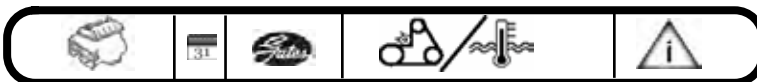

V6, 3.7 L	2008	38001	TENSOR	
		38167	TENSOR	
		38009	TENSOR	
		38167	TENSOR PARA BANDA MICRO-V	
V6, 3.7 L	2007	38009	TENSOR	
		38001	TENSOR	
		38167	TENSOR	
4 CIL. 2.5 L	1994	T41001	TENSOR- POLEA DE DIST.	
4 CIL. 2.5 L	1993	T41001	TENSOR- POLEA DE DIST.	
4 CIL. 2.5 L	1992	T41001	TENSOR- POLEA DE DIST.	
V6, 3.9 L	1991	36103	POLEA	POLEA LOCA
V6, 3.9 L	1990	36103	POLEA	POLEA LOCA
V6, 3.9 L	1989	36103	POLEA	POLEA LOCA
4 CIL. 2.2 L	1988	T41000	TENSOR- POLEA DE DIST.	
V6, 3.9 L	1988	36103	POLEA	POLEA LOCA
4 CIL. 2.2 L	1987	T41000	TENSOR- POLEA DE DIST.	
V6, 3.9 L	1987	36103	POLEA	POLEA LOCA

**CHARGER**

V6, 3.5 L	2009	TCK295A	KIT DE DISTRIBUCION	
		36313	POLEA	
		38323	TENSOR	
		38082	TENSOR	
		T43197	TENSOR- POLEA DE DIST.	
V8, 5.7 L	2009	36313	POLEA	
		38018	TENSOR	
		38323	TENSOR	
V8, 6.1 L	2009	38323	TENSOR	
V6, 3.5 L	2008	38323	TENSOR	
		38082	TENSOR	
V8, 5.7 L	2008	38323	TENSOR	
		38018	TENSOR	
V8, 6.1 L	2008	38323	TENSOR	
		38018	TENSOR	
V6, 3.5 L	2007	38323	TENSOR	
		38082	TENSOR	
V8, 5.7 L	2007	38018	TENSOR	
		38323	TENSOR	
V8, 6.1 L	2007	38323	TENSOR	
		38018	TENSOR	
4 CIL. 2.2 L	1987	T41000	TENSOR- POLEA DE DIST.	
4 CIL. 2.2 L	1986	T41000	TENSOR- POLEA DE DIST.	
4 CIL. 2.2 L	1985	T41000	TENSOR- POLEA DE DIST.	
4 CIL. 2.2 L	1984	T41000	TENSOR- POLEA DE DIST.	
4 CIL. 2.2 L	1983	T41000	TENSOR- POLEA DE DIST.	

**DIPLOMAT**

V8, 5.2 L	1989	36103	POLEA	POLEA LOCA
V8, 5.2 L	1988	36103	POLEA	POLEA LOCA
V8, 5.2 L	1987	36103	POLEA	POLEA LOCA
V8, 5.2 L	1986	36103	POLEA	POLEA LOCA
V8, 5.2 L	1985	36103	POLEA	POLEA LOCA

**DURANGO**

V8, 5.7 L	2009	38323	TENSOR	
		38018	TENSOR	
V8, 5.7 L	2008	38323	TENSOR	
		38018	TENSOR	
V8, 5.7 L	2007	38058	POLEA	REQUIERE 2
		38058	TENSOR	REQUIERE 2
		38382	TENSOR	
		38382	TENSOR PARA BANDA MICRO-V	
V8, 4.7 L	2006	38001	TENSOR	
		38009	TENSOR	
		38167	TENSOR	
V8, 5.7 L	2006	38058	TENSOR	REQUIERE 2
		38382	TENSOR	
V6, 3.7 L	2005	38167	TENSOR	
		38001	TENSOR	
		38009	TENSOR	
V8, 4.7 L	2005	38001	TENSOR	
		38167	TENSOR	
		38009	TENSOR	
V8, 5.7 L	2005	38058	TENSOR	
V6, 3.7 L	2004	38001	TENSOR	
		38167	TENSOR	
		38009	TENSOR	
V8, 4.7 L	2004	38042	TENSOR	
		38001	TENSOR	
		38167	TENSOR	
		38009	TENSOR	
V8, 5.7 L	2004	38058	TENSOR	
V8, 4.7 L	2003	38042	TENSOR	
		38001	TENSOR	
		38009	TENSOR	
		38167	TENSOR	
V8, 5.9 L	2003	38033	TENSOR	
		38116	TENSOR	
		38016	TENSOR	
V8, 4.7 L	2002	38009	TENSOR	
		38167	TENSOR	
		38001	TENSOR	
		38042	TENSOR	
V8, 5.9 L	2002	38016	TENSOR	
		38116	TENSOR	
		38033	TENSOR	
V8, 4.7 L	2001	38001	TENSOR	
		38009	TENSOR	
		38167	TENSOR	

**D & W SERIES PICKUP**

V8, 5.9 L	1992	36103	POLEA	POLEA LOCA
V6, 3.9 L	1991	36103	POLEA	POLEA LOCA
V8, 5.2 L	1991	36103	POLEA	POLEA LOCA
V8, 5.9 L	1991	36103	POLEA	POLEA LOCA
V6, 3.9 L	1990	36103	POLEA	POLEA LOCA
V8, 5.2 L	1990	36103	POLEA	POLEA LOCA
V8, 5.9 L	1990	36103	POLEA	POLEA LOCA
V6, 3.9 L	1989	36103	POLEA	POLEA LOCA
V8, 5.2 L	1989	36103	POLEA	POLEA LOCA
V8, 5.9 L	1989	36103	POLEA	POLEA LOCA
V6, 3.9 L	1988	36103	POLEA	POLEA LOCA
V8, 5.2 L	1988	36103	POLEA	POLEA LOCA
V8, 5.9 L	1988	36103	POLEA	POLEA LOCA
6 CIL. 3.7 L	1987	36103	POLEA	POLEA LOCA
V8, 5.2 L	1987	36103	POLEA	POLEA LOCA
V8, 5.9 L	1987	36103	POLEA	POLEA LOCA
V8, 5.2 L	1986	36103	POLEA	POLEA LOCA
V8, 5.9 L	1986	36103	POLEA	POLEA LOCA

**D-150**

V6, 3.9 L	1993	38016	TENSOR	
		38116	TENSOR	

**D-250**

V8, 5.9 L	1993	38116	TENSOR	
		38016	TENSOR	

**D-350**

V8, 5.9 L	1993	38116	TENSOR	
		38016	TENSOR	

**DAKOTA**



V8, 5.9 L	2001	38016	TENSOR		
		38033	TENSOR		
		38116	TENSOR		
V8, 4.7 L	2000	38009	TENSOR		
		38167	TENSOR		
		38001	TENSOR		
V8, 5.2 L	2000	38016	TENSOR		
		38116	TENSOR		
		38033	TENSOR		
V8, 5.9 L	2000	38033	TENSOR		
		38116	TENSOR		
		38016	TENSOR		
V6, 3.9 L	1999	38033	TENSOR		
		38016	TENSOR		
		38116	TENSOR		
V8, 5.2 L	1999	38033	TENSOR		
		38016	TENSOR		
		38116	TENSOR		
V8, 5.9 L	1999	38033	TENSOR		
		38116	TENSOR		
		38016	TENSOR		
V6, 3.9 L	1998	38016	TENSOR		
		38033	TENSOR		
		38116	TENSOR		
V8, 5.2 L	1998	38033	TENSOR		
		38116	TENSOR		
		38016	TENSOR		
V8, 5.9 L	1998	38116	TENSOR		
		38016	TENSOR		
		38033	TENSOR		

V6, 2.7 L	2000	38042	TENSOR		ALT.
		T41084	TENSOR- POLEA DE DIST.		
		36100	POLEA		A.A.
		38043	TENSOR		
		38043	TENSOR		ALT. Y D.H.
V6, 3.2 L	2000	TCK295	KIT DE DISTRIBUCION		
		38042	TENSOR		ALT.
		38020	TENSOR		
		38040	TENSOR		A.A.
		T41084	TENSOR- POLEA DE DIST.		
V6, 3.5 L	2000	TCK295	KIT DE DISTRIBUCION		
		38020	TENSOR		
		38042	TENSOR		ALT.
		38040	TENSOR		A.A.
		T41084	TENSOR- POLEA DE DIST.		
V6, 2.7 L	1999	36100	POLEA		A.A.
		38043	TENSOR		ALT. Y D.H.
		38043	TENSOR		
V6, 3.2 L	1999	TCK295	KIT DE DISTRIBUCION		
		38042	TENSOR		ALT.
		38020	TENSOR		
		38040	TENSOR		A.A.
		T41084	TENSOR- POLEA DE DIST.		
V6, 2.7 L	1998	36100	POLEA		A.A.
		38043	TENSOR		ALT. Y D.H.
		38043	TENSOR		
V6, 3.2 L	1998	TCK295	KIT DE DISTRIBUCION		
		38040	TENSOR		A.A.
		38042	TENSOR		ALT.
		38020	TENSOR		
		T41084	TENSOR- POLEA DE DIST.		
V6, 3.3 L	1997	38003	TENSOR		A.A.
V6, 3.5 L	1997	TCK255	KIT DE DISTRIBUCION		
		38004	POLEA		
		38004	TENSOR		
		38020	TENSOR		
		38042	TENSOR		ALT. Y D.H.
		38040	TENSOR		A.A.
		T41002	TENSOR- POLEA DE DIST.		
V6, 3.3 L	1996	38003	TENSOR		
V6, 3.5 L	1996	TCK255	KIT DE DISTRIBUCION		
		38040	TENSOR		A.A.
		38042	TENSOR		ALT.
		38020	TENSOR		
		T41002	TENSOR- POLEA DE DIST.		
V6, 3.3 L	1995	38003	TENSOR		
V6, 3.5 L	1995	TCK255	KIT DE DISTRIBUCION		
		38040	TENSOR		A.A.
		38020	TENSOR		
		38042	TENSOR		ALT.
		T41002	TENSOR- POLEA DE DIST.		
V6, 3.3 L	1994	38003	TENSOR		
V6, 3.5 L	1994	TCKWP219	KIT DE DISTRIBUCION CON B.A.		
		38020	TENSOR		
V6, 3.5 L	1993	TCKWP219	KIT DE DISTRIBUCION CON B.A.		

**EXPO**

4 CIL. 2.2 L (Canada)	1988	T41000	TENSOR- POLEA DE DIST.
4 CIL. 2.2 L (Canada)	1987	T41000	TENSOR- POLEA DE DIST.

**GRAND CARAVAN**

V6, 3.0 L	2000	T41048	TENSOR- POLEA DE DIST.
V6, 3.0 L	1999	T41048	TENSOR- POLEA DE DIST.
V6, 3.0 L	1998	T41048	TENSOR- POLEA DE DIST.
4 CIL. 2.4 L	1997	T43131	TENSOR- POLEA DE DIST.
V6, 3.0 L	1997	T41048	TENSOR- POLEA DE DIST.
V6, 3.0 L	1996	T41048	TENSOR- POLEA DE DIST.
V6, 3.0 L	1995	T41048	TENSOR- POLEA DE DIST.
V6, 3.0 L	1994	T41048	TENSOR- POLEA DE DIST.
V6, 3.0 L	1993	T41048	TENSOR- POLEA DE DIST.
V6, 3.0 L	1992	T41048	TENSOR- POLEA DE DIST.
4 CIL. 2.2 L	1987	T41000	TENSOR- POLEA DE DIST.

**INTREPID**

V6, 3.5 L	2004	T43148	TENSOR- POLEA DE DIST.	HIDRAULICO
V6, 2.7 L	2003	36100	POLEA	A.A.
		38043	TENSOR	ALTERNADOR, DIRECCION HI
		38009	TENSOR	A.A.
V6, 3.5 L	2003	T43148	TENSOR- POLEA DE DIST.	HIDRAULICO
V6, 2.7 L	2002	36100	POLEA	A.A.
		38043	TENSOR	
		38043	TENSOR	ALTERNADOR, DIRECCION HI
		38009	TENSOR	A.A.
V6, 3.5 L	2002	TCK295	KIT DE DISTRIBUCION	A.A.
		38040	TENSOR	
		38042	TENSOR	
		T41084	TENSOR- POLEA DE DIST.	
V6, 2.7 L	2001	36100	POLEA	A.A.
		38043	TENSOR	ALT. Y D.H.
		38043	TENSOR	
V6, 3.2 L	2001	TCK295	KIT DE DISTRIBUCION	
		38042	TENSOR	ALT.
		38040	TENSOR	A.A.
V6, 3.5 L	2001	TCK295	KIT DE DISTRIBUCION	
		38040	TENSOR	A.A.

**JOURNEY**

4 CIL. 2.4 L	2010	38323	TENSOR
V6, 3.5 L	2010	TCK295A	KIT DE DISTRIBUCION
		36313	POLEA
		38018	TENSOR
		38417	TENSOR
		T43197	TENSOR- POLEA DE DIST.
4 CIL. 2.4 L	2009	38323	TENSOR
V6, 3.5 L	2009	TCK295A	KIT DE DISTRIBUCION
		36313	POLEA
		38018	TENSOR
		38417	TENSOR
		T43197	TENSOR- POLEA DE DIST.

**LANCER**

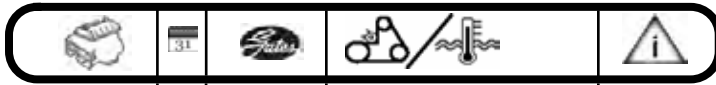

4 CIL. 2.2 L	1988	T41000	TENSOR- POLEA DE DIST.
4 CIL. 2.2 L	1987	T41000	TENSOR- POLEA DE DIST.
4 CIL. 2.2 L	1986	T41000	TENSOR- POLEA DE DIST.
4 CIL. 2.2 L	1985	T41000	TENSOR- POLEA DE DIST.



4 CIL. 2.0 L	1997	TCK246	KIT DE DISTRIBUCION
		TCKWP245A	KIT DE DISTRIBUCION CON B.A.
		TCKWP246	KIT DE DISTRIBUCION CON B.A.
		TCKWP245B	KIT DE DISTRIBUCION CON B.A.
		TCKWP245	KIT DE DISTRIBUCION CON B.A.
		T41002	TENSOR- POLEA DE DIST.
		T43132	TENSOR- POLEA DE DIST.
		T43001	TENSOR- POLEA DE DIST.
		TCK246	KIT DE DISTRIBUCION
		TCK245	KIT DE DISTRIBUCION
		TCKWP245	KIT DE DISTRIBUCION CON B.A.
		TCKWP245B	KIT DE DISTRIBUCION CON B.A.
		TCKWP246	KIT DE DISTRIBUCION CON B.A.
		TCKWP245A	KIT DE DISTRIBUCION CON B.A.
		T41002	TENSOR- POLEA DE DIST.
T43001	TENSOR- POLEA DE DIST.		
T43132	TENSOR- POLEA DE DIST.		
TCK246	KIT DE DISTRIBUCION		
TCK245	KIT DE DISTRIBUCION		
TCKWP245A	KIT DE DISTRIBUCION CON B.A.		
TCKWP246	KIT DE DISTRIBUCION CON B.A.		
TCKWP245B	KIT DE DISTRIBUCION CON B.A.		
TCKWP245	KIT DE DISTRIBUCION CON B.A.		
T41002	TENSOR- POLEA DE DIST.		
T43132	TENSOR- POLEA DE DIST.		
T43001	TENSOR- POLEA DE DIST.		
TCK246	KIT DE DISTRIBUCION		
TCK245	KIT DE DISTRIBUCION		
TCKWP245	KIT DE DISTRIBUCION CON B.A.		
TCKWP246	KIT DE DISTRIBUCION CON B.A.		
T41002	TENSOR- POLEA DE DIST.		
T43132	TENSOR- POLEA DE DIST.		

**MINI RAM VAN**

4 CIL. 2.2 L	1987	T41000	TENSOR- POLEA DE DIST.
4 CIL. 2.2 L	1986	T41000	TENSOR- POLEA DE DIST.
4 CIL. 2.2 L	1985	T41000	TENSOR- POLEA DE DIST.
4 CIL. 2.2 L	1984	T41000	TENSOR- POLEA DE DIST.

**NEON**

4 CIL. 2.0 L	2006	36156	POLEA
		36156	POLEA
		38277	TENSOR
		38277	TENSOR PARA BANDA MICRO-V
4 CIL. 2.4 L	2006	TCKWP265C	KIT DE DISTRIBUCION CON B.A.
4 CIL. 2.0 L	2005	TCKWP245B	KIT DE DISTRIBUCION CON B.A.
		TCKWP245A	KIT DE DISTRIBUCION CON B.A.
		T43001	TENSOR- POLEA DE DIST.
		T43132	TENSOR- POLEA DE DIST.
4 CIL. 2.4 L	2005	TCKWP265C	KIT DE DISTRIBUCION CON B.A.
		T43131	TENSOR- POLEA DE DIST.
		T43008	TENSOR- POLEA DE DIST.
		T42121	TENSOR- POLEA DE DIST.
4 CIL. 2.0 L	2004	TCKWP245B	KIT DE DISTRIBUCION CON B.A.
		TCKWP245A	KIT DE DISTRIBUCION CON B.A.
		36156	POLEA
		38277	TENSOR
		T43001	TENSOR- POLEA DE DIST.
		T43132	TENSOR- POLEA DE DIST.
4 CIL. 2.4 L	2004	TCKWP265C	KIT DE DISTRIBUCION CON B.A.
		38176	TENSOR
		T43131	TENSOR- POLEA DE DIST.
		T42121	TENSOR- POLEA DE DIST.
		T43008	TENSOR- POLEA DE DIST.
4 CIL. 2.0 L	2003	TCKWP245A	KIT DE DISTRIBUCION CON B.A.
		TCKWP245B	KIT DE DISTRIBUCION CON B.A.
		T43001	TENSOR- POLEA DE DIST.
		T43132	TENSOR- POLEA DE DIST.
4 CIL. 2.4 L	2003	TCKWP265C	KIT DE DISTRIBUCION CON B.A.
		T42121	TENSOR- POLEA DE DIST.
		T43008	TENSOR- POLEA DE DIST.
		T43131	TENSOR- POLEA DE DIST.
4 CIL. 2.0 L	2002	TCK245	KIT DE DISTRIBUCION
		TCKWP245B	KIT DE DISTRIBUCION CON B.A.
		TCKWP245A	KIT DE DISTRIBUCION CON B.A.
		T43132	TENSOR- POLEA DE DIST.
		T41002	TENSOR- POLEA DE DIST.
		T43001	TENSOR- POLEA DE DIST.
4 CIL. 2.0 L	2001	TCK245	KIT DE DISTRIBUCION
		TCKWP245A	KIT DE DISTRIBUCION CON B.A.
		TCKWP245B	KIT DE DISTRIBUCION CON B.A.
		T41002	TENSOR- POLEA DE DIST.
		T43132	TENSOR- POLEA DE DIST.
		T43001	TENSOR- POLEA DE DIST.
4 CIL. 2.0 L	2000	TCK245	KIT DE DISTRIBUCION
		TCKWP245A	KIT DE DISTRIBUCION CON B.A.
		TCKWP245B	KIT DE DISTRIBUCION CON B.A.
		T43132	TENSOR- POLEA DE DIST.
		T41002	TENSOR- POLEA DE DIST.
		T43001	TENSOR- POLEA DE DIST.
4 CIL. 2.0 L	1999	TCK246	KIT DE DISTRIBUCION
		TCK245	KIT DE DISTRIBUCION
		TCKWP245B	KIT DE DISTRIBUCION CON B.A.
		TCKWP246	KIT DE DISTRIBUCION CON B.A.
		TCKWP245A	KIT DE DISTRIBUCION CON B.A.
		T41002	TENSOR- POLEA DE DIST.
		T43001	TENSOR- POLEA DE DIST.
		T43132	TENSOR- POLEA DE DIST.
4 CIL. 2.0 L	1998	TCK245	KIT DE DISTRIBUCION

SERPENTIN

DOHC  
SOHC

**NITRO**

6v. 4.0 L	2010	91030	HERRAMIENTA INST. STRECH FIT
		TCK295A	KIT DE DISTRIBUCION
		38018	TENSOR
		38009	TENSOR
		T43197	TENSOR- POLEA DE DIST.
6v. 4.0 L	2009	91030	HERRAMIENTA INST. STRECH FIT
		TCK295A	KIT DE DISTRIBUCION
		38018	TENSOR
		38009	TENSOR
		T43197	TENSOR- POLEA DE DIST.
6v. 3.7 L	2008	38009	TENSOR
		38001	TENSOR
		38167	TENSOR
6v. 4.0 L	2008	38018	TENSOR
		38009	TENSOR
6v. 3.7 L	2007	38009	TENSOR
		38001	TENSOR
		38167	TENSOR
6v. 4.0 L	2007	38018	TENSOR
		38009	TENSOR

LISA  
RANURADA

LISA  
RANURADA

LISA SUP.  
RANURADA INF.

LISA SUP.  
RANURADA INF.

**OMNI**

4 CIL. 2.2 L	1988	T41000	TENSOR- POLEA DE DIST.
4 CIL. 2.2 L	1987	T41000	TENSOR- POLEA DE DIST.
4 CIL. 2.2 L	1986	T41000	TENSOR- POLEA DE DIST.
4 CIL. 2.2 L	1985	T41000	TENSOR- POLEA DE DIST.
4 CIL. 2.2 L	1984	T41000	TENSOR- POLEA DE DIST.
4 CIL. 2.2 L	1983	T41000	TENSOR- POLEA DE DIST.
4 CIL. 2.2 L	1982	T41000	TENSOR- POLEA DE DIST.
4 CIL. 2.2 L	1981	T41000	TENSOR- POLEA DE DIST.

**RAM 1500**

6v. 3.7 L	2007	38009	TENSOR
		38015	TENSOR
6v. 3.7 L	2006	38009	TENSOR
		38015	TENSOR

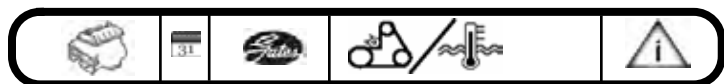

V6, 3.7 L	2005	38042	TENSOR
		38167	TENSOR
V6, 3.7 L	2004	38167	TENSOR
V6, 3.7 L	2003	38042	TENSOR
V6, 3.7 L	2002	38042	TENSOR
V6, 3.9 L	2001	38116	TENSOR
		38016	TENSOR
V6, 3.9 L	2000	38016	TENSOR
		38116	TENSOR
V6, 3.9 L	1999	38116	TENSOR
		38016	TENSOR
V6, 3.9 L	1998	38116	TENSOR
		38016	TENSOR
V6, 3.9 L	1997	38016	TENSOR
		38116	TENSOR
V6, 3.9 L	1996	38116	TENSOR
		38016	TENSOR
V6, 3.9 L	1995	38016	TENSOR
		38116	TENSOR
V6, 3.9 L	1994	38016	TENSOR
		38116	TENSOR



V8, 5.7 L	2007	38382	TENSOR
		38058	TENSOR
V8, 5.7 L	2006	38382	TENSOR
		38058	TENSOR
V8, 5.7 L	2005	38058	TENSOR
		38382	TENSOR
V8, 5.7 L	2004	38058	TENSOR
		38382	TENSOR
V8, 5.7 L	2003	38058	TENSOR
		38382	TENSOR
V8, 5.9 L	2002	38116	TENSOR
		38016	TENSOR
V8, 5.9 L	2001	38016	TENSOR
		38116	TENSOR
V8, 5.9 L	2000	38116	TENSOR
		38016	TENSOR
V8, 5.9 L	1999	38116	TENSOR
		38016	TENSOR
V8, 5.9 L	1998	38116	TENSOR
		38016	TENSOR
V8, 5.9 L	1997	38116	TENSOR
		38016	TENSOR
V8, 5.9 L	1996	38016	TENSOR
		38116	TENSOR
V8, 5.9 L	1995	38116	TENSOR
		38016	TENSOR
V8, 5.9 L	1994	38016	TENSOR
		38116	TENSOR

**RAM 2500**

V8, 5.7 L	2009	36313	POLEA
		38018	TENSOR
		38323	TENSOR
V8, 5.7 L	2008	38382	TENSOR
		38058	TENSOR
V8, 4.7 L	2007	38009	TENSOR
		38015	TENSOR
V8, 4.7 L	2006	38009	TENSOR
		38015	TENSOR
V8, 4.7 L	2005	38009	TENSOR
		38015	TENSOR
V8, 4.7 L	2004	38009	TENSOR
		38015	TENSOR
V8, 4.7 L	2003	38167	TENSOR
		38009	TENSOR
		38042	TENSOR
V8, 4.7 L	2002	38009	TENSOR
		38167	TENSOR
		38042	TENSOR
V8, 5.9 L	2002	38116	TENSOR
		38016	TENSOR
V8, 5.2 L	2001	38116	TENSOR
		38016	TENSOR
V8, 5.9 L	2001	38116	TENSOR
V8, 5.2 L	2000	38116	TENSOR
		38016	TENSOR
V8, 5.9 L	2000	38116	TENSOR
		38016	TENSOR
V8, 5.2 L	1999	38116	TENSOR
		38016	TENSOR
V8, 5.9 L	1999	38116	TENSOR
		38016	TENSOR
V8, 5.2 L	1998	38016	TENSOR
		38116	TENSOR
V8, 5.9 L	1998	38016	TENSOR
		38116	TENSOR
V8, 5.2 L	1997	38116	TENSOR
		38016	TENSOR
V8, 5.9 L	1997	38016	TENSOR
		38116	TENSOR
V8, 5.9 L	1996	38116	TENSOR
		38016	TENSOR
V8, 5.9 L	1995	38116	TENSOR
		38016	TENSOR
V8, 5.9 L	1994	38016	TENSOR
		38116	TENSOR

**RAM 4000**

V6, 6.7 L DIESEL	2009	36315	POLEA
		38285	TENSOR
V6, 5.9 L DIESEL	2008	36315	POLEA
		38285	TENSOR
V6, 6.7 L DIESEL	2008	36315	POLEA
		38285	TENSOR
V6, 5.9 L DIESEL	2007	38285	TENSOR
		38285	TENSOR PARA BANDA MICRO-V
V6, 5.9 L DIESEL	2006	38285	TENSOR
V6, 5.9 L DIESEL	2005	38285	TENSOR
V6, 5.9 L DIESEL	2004	38285	TENSOR
V6, 5.9 L DIESEL	2003	38285	TENSOR
V8, 5.9 L	2002	38016	TENSOR
		38116	TENSOR
V8, 5.9 L	2001	38116	TENSOR
		38016	TENSOR
V8, 5.9 L	2000	38016	TENSOR
		38116	TENSOR
V8, 5.9 L	1999	38016	TENSOR
		38116	TENSOR
V8, 5.9 L	1998	38116	TENSOR
		38016	TENSOR
V8, 5.9 L	1997	38116	TENSOR
		38016	TENSOR
V8, 5.9 L	1996	38016	TENSOR
V8, 5.9 L	1995	38116	TENSOR
		38016	TENSOR

**RAM 50 PICKUP**

4 CIL. 2.4 L	1993	T41043	TENSOR- POLEA DE DIST.	
		T41043	TENSOR- POLEA DE DIST.	
		T41047	TENSOR- POLEA DE DIST.	BALANCIN
		T41047	TENSOR- POLEA DE DIST.	BALANCIN
4 CIL. 2.4 L	1992	T41043	TENSOR- POLEA DE DIST.	
		T41043	TENSOR- POLEA DE DIST.	
		T41045	TENSOR- POLEA DE DIST.	BALANCIN
		T41045	TENSOR- POLEA DE DIST.	BALANCIN
4 CIL. 2.4 L	1991	T41043	TENSOR- POLEA DE DIST.	
		T41045	TENSOR- POLEA DE DIST.	BALANCIN
4 CIL. 2.4 L	1990	T41043	TENSOR- POLEA DE DIST.	
		T41045	TENSOR- POLEA DE DIST.	BALANCIN

**RAM 3500**



4 CIL. 2.0 L	1989	T41045	SENSOR- POLEA DE DIST.	BALANCIN
		T41043	SENSOR- POLEA DE DIST.	
4 CIL. 2.0 L	1988	T41045	SENSOR- POLEA DE DIST.	BALANCIN
		T41043	SENSOR- POLEA DE DIST.	
4 CIL. 2.0 L	1987	T41053	SENSOR- POLEA DE DIST.	BALANCIN
		T41043	SENSOR- POLEA DE DIST.	
		T41045	SENSOR- POLEA DE DIST.	BALANCIN
4 CIL. 2.3 L Diesel	1985	T41049	SENSOR- POLEA DE DIST.	BALANCIN
		T41050	SENSOR- POLEA DE DIST.	
4 CIL. 2.3 L Diesel	1984	T41049	SENSOR- POLEA DE DIST.	BALANCIN
		T41050	SENSOR- POLEA DE DIST.	
4 CIL. 2.3 L Diesel	1983	T41050	SENSOR- POLEA DE DIST.	BALANCIN
		T41049	SENSOR- POLEA DE DIST.	



**RAM MAXI WAGON 3500**

V8, 5.9 L	2002	38016	TENSOR
		38116	TENSOR
V8, 5.9 L	2001	38016	TENSOR
		38116	TENSOR
V8, 5.9 L	2000	38016	TENSOR
		38116	TENSOR
V8, 5.9 L	1999	38016	TENSOR
		38116	TENSOR
V8, 5.9 L	1998	38116	TENSOR
		38016	TENSOR
V8, 5.9 L	1997	38016	TENSOR
		38116	TENSOR
V8, 5.2 L	1996	38116	TENSOR
		38016	TENSOR
V8, 5.9 L	1996	38116	TENSOR
		38016	TENSOR

**RAM CHARGER**

V8, 5.9 L	1993	38016	TENSOR
		38116	TENSOR
V8, 5.9 L	1992	36103	POLEA
V8, 5.2 L	1991	36103	POLEA
V8, 5.9 L	1991	36103	POLEA
V8, 5.2 L	1990	36103	POLEA
V8, 5.9 L	1990	36103	POLEA
V8, 5.2 L	1989	36103	POLEA
V8, 5.9 L	1989	36103	POLEA
V8, 5.2 L	1988	36103	POLEA
V8, 5.9 L	1988	36103	POLEA
V8, 5.2 L	1987	36103	POLEA
V8, 5.9 L	1987	36103	POLEA
V8, 5.2 L	1986	36103	POLEA
V8, 5.9 L	1986	36103	POLEA

**RAM SERIES PICKUP**

V10, 8.0 L	2003	38033	TENSOR
V6, 3.7 L	2003	38042	TENSOR
		38001	TENSOR
		38009	TENSOR
		38167	TENSOR
V8, 4.7L	2003	38009	TENSOR
		38042	TENSOR
6 CIL. 5.9 L	2002	36094	POLEA
		38157	TENSOR PARA BANDA MICRO-V
6 CIL. 5.9 L Diesel	2002	38157	TENSOR
V10, 8.0 L	2002	38033	TENSOR
V6, 3.7 L	2002	38042	TENSOR
		38167	TENSOR
		38001	TENSOR
		38009	TENSOR
V8, 4.7L	2002	38042	TENSOR
		38009	TENSOR
V8, 5.9 L	2002	38016	TENSOR
		38033	TENSOR
		38116	TENSOR
6 CIL. 5.9 L Diesel	2001	38157	TENSOR
V10, 8.0 L	2001	38033	TENSOR
V6, 3.9 L	2001	38116	TENSOR
		38016	TENSOR
		38033	TENSOR
V8, 5.2 L	2001	38016	TENSOR
		38116	TENSOR
		38033	TENSOR
V8, 5.9 L	2001	38033	TENSOR
		38116	TENSOR
		38016	TENSOR
		38058	TENSOR
		38180	TENSOR
6 CIL. 5.9 L Diesel	2000	38157	TENSOR
V10, 8.0 L	2000	38058	TENSOR
		38033	TENSOR
		38180	TENSOR
		38180	TENSOR PARA BANDA MICRO-V
V6, 3.9 L	2000	38033	TENSOR
		38016	TENSOR
		38116	TENSOR
V8, 5.2 L	2000	38033	TENSOR
		38016	TENSOR
		38116	TENSOR
V8, 5.9 L	2000	38116	TENSOR
		38116	TENSOR
V8, 5.9 L	1999	38016	TENSOR
		38116	TENSOR
V8, 5.9 L	1998	38016	TENSOR
		38116	TENSOR
V8, 5.9 L	1997	38016	TENSOR
		38180	TENSOR
V8, 5.9 L	1996	38016	TENSOR
		38058	TENSOR
		38033	TENSOR
6 CIL. 5.9 L Diesel	1999	38157	TENSOR
V10, 8.0 L	1999	38058	TENSOR

**RAM MAXI VAN 1500**

V6, 3.9 L	2002	38016	TENSOR
		38116	TENSOR
V6, 3.9 L	1999	38016	TENSOR
		38116	TENSOR

**RAM MAXI VAN 2500**

V8, 5.2 L	2002	38116	TENSOR
		38016	TENSOR
V8, 5.2 L	2001	38116	TENSOR
		38016	TENSOR
V8, 5.2 L	2000	38016	TENSOR
		38116	TENSOR
V8, 5.2 L	1999	38116	TENSOR
		38016	TENSOR
V8, 5.2 L	1998	38116	TENSOR
		38016	TENSOR
V8, 5.2 L	1997	38116	TENSOR
		38016	TENSOR
V8, 5.2 L	1996	38016	TENSOR
		38116	TENSOR

**RAM MAXI VAN 3500**

V8, 5.9 L	2002	38116	TENSOR
		38016	TENSOR
V8, 5.9 L	2001	38116	TENSOR
		38016	TENSOR
V8, 5.9 L	2000	38116	TENSOR
		38016	TENSOR
V8, 5.9 L	1999	38016	TENSOR
		38116	TENSOR
V8, 5.9 L	1998	38016	TENSOR
		38116	TENSOR
V8, 5.9 L	1997	38016	TENSOR
		38116	TENSOR
V8, 5.9 L	1996	38016	TENSOR
		38116	TENSOR

V10, 8.0 L	1999	38180	TENSOR		
		38033	TENSOR		
V6, 3.9 L	1999	38116	TENSOR		
		38033	TENSOR		
V8, 5.2 L	1999	38016	TENSOR		
		38033	TENSOR		
V8, 5.9 L	1999	38116	TENSOR		
		38016	TENSOR		
		38180	TENSOR		
		38058	TENSOR		
		38116	TENSOR		
V6, 3.9 L	1998	38033	TENSOR		
		38016	TENSOR		
		38116	TENSOR		
		38033	TENSOR		
V8, 5.2 L	1998	38033	TENSOR		
		38116	TENSOR		
		38016	TENSOR		
V8, 5.9 L	1998	38058	TENSOR		
		38033	TENSOR		
		38116	TENSOR		
		38016	TENSOR		
V6, 3.9 L	1997	38016	TENSOR		
		38033	TENSOR		
		38116	TENSOR		
V8, 5.2 L	1997	38016	TENSOR		
		38033	TENSOR		
V8, 5.9 L	1997	38116	TENSOR		
		38180	TENSOR		
		38016	TENSOR		
		38058	TENSOR		
		38033	TENSOR		
V6, 3.9 L	1996	38033	TENSOR		
		38116	TENSOR		
		38016	TENSOR		
V8, 5.2 L	1996	38033	TENSOR		
		38116	TENSOR		
		38016	TENSOR		
V8, 5.9 L	1996	38033	TENSOR		
		38016	TENSOR		
V6, 3.9 L	1995	38033	TENSOR		
		38016	TENSOR		
		38116	TENSOR		
V8, 5.2 L	1995	38033	TENSOR		
		38016	TENSOR		
V8, 5.9 L	1995	38016	TENSOR		
		38116	TENSOR		
		38033	TENSOR		
V6, 3.9 L	1994	38016	TENSOR		
		38116	TENSOR		
V8, 5.9 L	1994	38116	TENSOR		
		38016	TENSOR		

MOTOR SERIE Z

MOTOR SERIE Z

MOTOR SERIE Z

MOTOR SERIE Z

V8, 5.2 L	2001	38016	TENSOR		
		38116	TENSOR		
V8, 5.2 L	2000	38116	TENSOR		
		38016	TENSOR		
V8, 5.2 L	1999	38116	TENSOR		
		38016	TENSOR		
V8, 5.2 L	1998	38116	TENSOR		
		38016	TENSOR		
V8, 5.2 L	1997	38116	TENSOR		
		38016	TENSOR		
V8, 5.9 L	1995	38116	TENSOR		
		38016	TENSOR		
V8, 5.9 L	1994	38016	TENSOR		
		38116	TENSOR		

**RAM WAGON 3500**

V8, 5.9 L	2002	38116	TENSOR		
		38016	TENSOR		

**SEBRING**

4 CIL. 2.4 L	2006	TCKWP265A	KIT DE DISTRIBUCION CON B.A.		
		TCKWP265	KIT DE DISTRIBUCION CON B.A.		
4 CIL. 2.4 L	2005	TCKWP265	KIT DE DISTRIBUCION CON B.A.		
		TCKWP265A	KIT DE DISTRIBUCION CON B.A.		
V6, 3.0 L	2005	TCKWP259	KIT DE DISTRIBUCION CON B.A.		
4 CIL. 2.4 L	2004	TCKWP265	KIT DE DISTRIBUCION CON B.A.		
		TCKWP265A	KIT DE DISTRIBUCION CON B.A.		
V6, 3.0 L	2004	TCKWP259	KIT DE DISTRIBUCION CON B.A.		
4 CIL. 2.4 L	2003	TCKWP265A	KIT DE DISTRIBUCION CON B.A.		
		TCKWP265	KIT DE DISTRIBUCION CON B.A.		
V6, 3.0 L	2003	TCKWP259	KIT DE DISTRIBUCION CON B.A.		
V6, 3.0 L	2002	TCKWP259	KIT DE DISTRIBUCION CON B.A.		
V6, 3.0 L	2001	TCKWP259	KIT DE DISTRIBUCION CON B.A.		

**SHADOW**

4 CIL. 2.5 L	1995	38003	TENSOR		
4 CIL. 2.2 L	1994	TCK153	KIT DE DISTRIBUCION		A.A.
		38003	TENSOR		
		T41001	TENSOR- POLEA DE DIST.		
4 CIL. 2.5 L	1994	TCK153	KIT DE DISTRIBUCION		A.A.
		38003	TENSOR		
		T41001	TENSOR- POLEA DE DIST.		
V6, 3.0 L	1994	T41048	TENSOR- POLEA DE DIST.		
4 CIL. 2.2 L	1993	T41001	TENSOR- POLEA DE DIST.		
4 CIL. 2.5 L	1993	38003	TENSOR		
		T41001	TENSOR- POLEA DE DIST.		
V6, 3.0 L	1993	T41048	TENSOR- POLEA DE DIST.		
4 CIL. 2.2 L	1992	T41001	TENSOR- POLEA DE DIST.		
4 CIL. 2.5 L	1992	T41001	TENSOR- POLEA DE DIST.		
V6, 3.0 L	1992	T41048	TENSOR- POLEA DE DIST.		
4 CIL. 2.2 L	1988	T41000	TENSOR- POLEA DE DIST.		
4 CIL. 2.2 L	1987	T41000	TENSOR- POLEA DE DIST.		

**SPIRIT**

V6, 3.0 L	1995	TCKWP139	KIT DE DISTRIBUCION CON B.A.		
		T41048	TENSOR- POLEA DE DIST.		
4 CIL. 2.5 L	1994	TCK153	KIT DE DISTRIBUCION		
		38003	TENSOR		
		T41001	TENSOR- POLEA DE DIST.		
V6, 3.0 L	1994	TCK139	KIT DE DISTRIBUCION		
		TCKWP139	KIT DE DISTRIBUCION CON B.A.		
		38042	TENSOR		SERPENTIN
		38003	TENSOR		A.A.
		38122	TENSOR		SERPENTIN
		T41048	TENSOR- POLEA DE DIST.		
		T41048	TENSOR- POLEA DE DIST.		
4 CIL. 2.5 L	1993	38003	TENSOR		
		T41001	TENSOR- POLEA DE DIST.		
V6, 3.0 L	1993	TCKWP139	KIT DE DISTRIBUCION CON B.A.		
		T41048	TENSOR- POLEA DE DIST.		

**RAM WAGON 1500**

V8, 5.2 L	2001	38016	TENSOR		
		38116	TENSOR		
V8, 5.2 L	2000	38016	TENSOR		
		38116	TENSOR		
V8, 5.2 L	1999	38016	TENSOR		
		38116	TENSOR		
V8, 5.2 L	1998	38016	TENSOR		
		38116	TENSOR		
V8, 5.2 L	1997	38116	TENSOR		
		38016	TENSOR		

**RAM WAGON 2500**

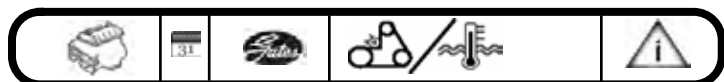

4 CIL. 2.5 L	1992	T41001	TENSOR- POLEA DE DIST.
V6. 3.0 L	1992	TCKWP139	KIT DE DISTRIBUCION CON B.A.
		T41048	TENSOR- POLEA DE DIST.
V6. 3.0 L	1991	TCKWP139	KIT DE DISTRIBUCION CON B.A.
V6. 3.0 L	1990	TCKWP139	KIT DE DISTRIBUCION CON B.A.
V6. 3.0 L	1989	TCKWP139	KIT DE DISTRIBUCION CON B.A.



V6. 3.0 L	2002	T43131	TENSOR- POLEA DE DIST.
		T43008	TENSOR- POLEA DE DIST.
		TCK259	KIT DE DISTRIBUCION
		TCKWP259	KIT DE DISTRIBUCION CON B.A.
		T42018	TENSOR- POLEA DE DIST.
		T41039	TENSOR- POLEA DE DIST.
		TCKWP245A	KIT DE DISTRIBUCION CON B.A.
		TCKWP245B	KIT DE DISTRIBUCION CON B.A.
		TCKWP265B	KIT DE DISTRIBUCION CON B.A.
		T42121	TENSOR- POLEA DE DIST.
		T41038	TENSOR- POLEA DE DIST.
		T43008	TENSOR- POLEA DE DIST.
		T43131	TENSOR- POLEA DE DIST.
		T42017	TENSOR- POLEA DE DIST.
		T41054	TENSOR- POLEA DE DIST.
		T43005	TENSOR- POLEA DE DIST.
		TCK259	KIT DE DISTRIBUCION
		TCKWP259	KIT DE DISTRIBUCION CON B.A.
		T41039	TENSOR- POLEA DE DIST.
		T42018	TENSOR- POLEA DE DIST.
		TCK245	KIT DE DISTRIBUCION
		TCKWP245A	KIT DE DISTRIBUCION CON B.A.
		TCKWP245B	KIT DE DISTRIBUCION CON B.A.
		38020	TENSOR
		38042	TENSOR
		T41002	TENSOR- POLEA DE DIST.
		T43132	TENSOR- POLEA DE DIST.
		T43001	TENSOR- POLEA DE DIST.
		TCKWP265B	KIT DE DISTRIBUCION CON B.A.
		38020	TENSOR
		38042	TENSOR
		T43131	TENSOR- POLEA DE DIST.
		T43005	TENSOR- POLEA DE DIST.
		T42121	TENSOR- POLEA DE DIST.
		T43008	TENSOR- POLEA DE DIST.
		TCK259	KIT DE DISTRIBUCION
		TCKWP259A	KIT DE DISTRIBUCION CON B.A.
		38020	TENSOR
		38042	TENSOR
		T41039	TENSOR- POLEA DE DIST.
		T42018	TENSOR- POLEA DE DIST.
		TCK245	KIT DE DISTRIBUCION
		TCKWP245B	KIT DE DISTRIBUCION CON B.A.
		TCKWP245A	KIT DE DISTRIBUCION CON B.A.
		38042	TENSOR
		38020	TENSOR
		T41002	TENSOR- POLEA DE DIST.
		T43132	TENSOR- POLEA DE DIST.
		T43001	TENSOR- POLEA DE DIST.
		T41002	TENSOR- POLEA DE DIST.
		TCKWP265B	KIT DE DISTRIBUCION CON B.A.

**STEALTH**

V6. 3.0 L	1996	TCKWP139	KIT DE DISTRIBUCION CON B.A.
		TCKWP195	KIT DE DISTRIBUCION CON B.A.
		T41048	TENSOR- POLEA DE DIST.
V6. 3.0 L	1995	TCKWP139	KIT DE DISTRIBUCION CON B.A.
		TCKWP195	KIT DE DISTRIBUCION CON B.A.
		T41048	TENSOR- POLEA DE DIST.
V6. 3.0 L	1994	TCKWP195	KIT DE DISTRIBUCION CON B.A.
		TCKWP139	KIT DE DISTRIBUCION CON B.A.
		T41048	TENSOR- POLEA DE DIST.
V6. 3.0 L	1993	TCKWP139	KIT DE DISTRIBUCION CON B.A.
		TCKWP195	KIT DE DISTRIBUCION CON B.A.
		T41048	TENSOR- POLEA DE DIST.
V6. 3.0 L	1992	TCKWP139	KIT DE DISTRIBUCION CON B.A.
		TCKWP195	KIT DE DISTRIBUCION CON B.A.
		T41048	TENSOR- POLEA DE DIST.
V6. 3.0 L	1991	TCKWP139	KIT DE DISTRIBUCION CON B.A.
		TCKWP195	KIT DE DISTRIBUCION CON B.A.

**STRATUS**

4 CIL. 2.4 L	2006	TCKWP265A	KIT DE DISTRIBUCION CON B.A.
		TCKWP265	KIT DE DISTRIBUCION CON B.A.
		T42121	TENSOR- POLEA DE DIST.
		T43008	TENSOR- POLEA DE DIST.
		T43131	TENSOR- POLEA DE DIST.
4 CIL. 2.0 L	2005	TCKWP245B	KIT DE DISTRIBUCION CON B.A.
		TCKWP245A	KIT DE DISTRIBUCION CON B.A.
4 CIL. 2.4 L	2005	TCKWP265	KIT DE DISTRIBUCION CON B.A.
		TCKWP265A	KIT DE DISTRIBUCION CON B.A.
		T43131	TENSOR- POLEA DE DIST.
V6. 3.0 L	2005	TCKWP259	KIT DE DISTRIBUCION CON B.A.
4 CIL. 2.0 L	2004	TCKWP245B	KIT DE DISTRIBUCION CON B.A.
		TCKWP245A	KIT DE DISTRIBUCION CON B.A.
4 CIL. 2.4 L	2004	TCKWP265A	KIT DE DISTRIBUCION CON B.A.
		TCKWP265	KIT DE DISTRIBUCION CON B.A.
		T43008	TENSOR- POLEA DE DIST.
		T42121	TENSOR- POLEA DE DIST.
		T43131	TENSOR- POLEA DE DIST.
		T41054	TENSOR- POLEA DE DIST.
		T41038	TENSOR- POLEA DE DIST.
		T42017	TENSOR- POLEA DE DIST.
V6. 3.0 L	2004	TCKWP259	KIT DE DISTRIBUCION CON B.A.
4 CIL. 2.0 L	2003	TCKWP245B	KIT DE DISTRIBUCION CON B.A.
		TCKWP245A	KIT DE DISTRIBUCION CON B.A.
4 CIL. 2.4 L	2003	TCKWP265A	KIT DE DISTRIBUCION CON B.A.
		TCKWP265	KIT DE DISTRIBUCION CON B.A.
		T43008	TENSOR- POLEA DE DIST.
		T43131	TENSOR- POLEA DE DIST.
		T41054	TENSOR- POLEA DE DIST.
		T42017	TENSOR- POLEA DE DIST.
		T42121	TENSOR- POLEA DE DIST.
		T41038	TENSOR- POLEA DE DIST.
V6. 3.0 L	2003	TCK259	KIT DE DISTRIBUCION
		TCKWP259	KIT DE DISTRIBUCION CON B.A.
		T42018	TENSOR- POLEA DE DIST.
		T41039	TENSOR- POLEA DE DIST.
4 CIL. 2.0 L	2002	TCKWP245B	KIT DE DISTRIBUCION CON B.A.
		TCKWP245A	KIT DE DISTRIBUCION CON B.A.
4 CIL. 2.4 L	2002	TCKWP265B	KIT DE DISTRIBUCION CON B.A.
		T43005	TENSOR- POLEA DE DIST.
		T41038	TENSOR- POLEA DE DIST.
		T41054	TENSOR- POLEA DE DIST.
		T42121	TENSOR- POLEA DE DIST.
		T42017	TENSOR- POLEA DE DIST.

4 CIL. 2.4 L	2000	TCKWP265B	KIT DE DISTRIBUCION CON B.A.
		38020	TENSOR
		38042	TENSOR
		T43131	TENSOR- POLEA DE DIST.
		T43005	TENSOR- POLEA DE DIST.
		T42121	TENSOR- POLEA DE DIST.
		T43008	TENSOR- POLEA DE DIST.
V6. 2.5 L	2000	TCK259	KIT DE DISTRIBUCION
		TCKWP259A	KIT DE DISTRIBUCION CON B.A.
		38020	TENSOR
		38042	TENSOR
		T41039	TENSOR- POLEA DE DIST.
		T42018	TENSOR- POLEA DE DIST.
4 CIL. 2.0 L	1999	TCK245	KIT DE DISTRIBUCION
		TCKWP245B	KIT DE DISTRIBUCION CON B.A.
		TCKWP245A	KIT DE DISTRIBUCION CON B.A.
		38042	TENSOR
		38020	TENSOR
		T41002	TENSOR- POLEA DE DIST.
		T43132	TENSOR- POLEA DE DIST.
		T43001	TENSOR- POLEA DE DIST.
4 CIL. 2.4 L	1999	TCKWP265B	KIT DE DISTRIBUCION CON B.A.
		38042	TENSOR
		38020	TENSOR
		T43131	TENSOR- POLEA DE DIST.
		T42121	TENSOR- POLEA DE DIST.
		T43008	TENSOR- POLEA DE DIST.
		T43005	TENSOR- POLEA DE DIST.
V6. 2.5 L	1999	TCK259	KIT DE DISTRIBUCION
		TCKWP259A	KIT DE DISTRIBUCION CON B.A.
		38042	TENSOR
		38020	TENSOR
		T41039	TENSOR- POLEA DE DIST.
		T42018	TENSOR- POLEA DE DIST.
4 CIL. 2.0 L	1998	TCK245	KIT DE DISTRIBUCION
		TCKWP245B	KIT DE DISTRIBUCION CON B.A.
		TCKWP245A	KIT DE DISTRIBUCION CON B.A.
		TCKWP245	KIT DE DISTRIBUCION CON B.A.
		38020	TENSOR
		38042	TENSOR
		T43132	TENSOR- POLEA DE DIST.
		T43001	TENSOR- POLEA DE DIST.
		T41002	TENSOR- POLEA DE DIST.
4 CIL. 2.4 L	1998	TCKWP265B	KIT DE DISTRIBUCION CON B.A.

4 CIL. 2.4 L	1998	38020	TENSOR	
		38042	TENSOR	
		T43131	TENSOR- POLEA DE DIST.	
		T42121	TENSOR- POLEA DE DIST.	
		T43005	TENSOR- POLEA DE DIST.	
		T43008	TENSOR- POLEA DE DIST.	
V6, 2.5 L	1998	TCK259	KIT DE DISTRIBUCION	
		TCKWP259A	KIT DE DISTRIBUCION CON B.A.	
		38042	TENSOR	
		T41039	TENSOR- POLEA DE DIST.	
		T42018	TENSOR- POLEA DE DIST.	
4 CIL. 2.0 L	1997	TCK245	KIT DE DISTRIBUCION	
		TCKWP245A	KIT DE DISTRIBUCION CON B.A.	
		TCKWP245	KIT DE DISTRIBUCION CON B.A.	
		TCKWP245B	KIT DE DISTRIBUCION CON B.A.	
		38020	TENSOR	
		38042	TENSOR	
		T41002	TENSOR- POLEA DE DIST.	
		T43132	TENSOR- POLEA DE DIST.	
		T43001	TENSOR- POLEA DE DIST.	
4 CIL. 2.4 L	1997	TCKWP265B	KIT DE DISTRIBUCION CON B.A.	
		38020	TENSOR	
		38042	TENSOR	
		T43005	TENSOR- POLEA DE DIST.	
		T42121	TENSOR- POLEA DE DIST.	
		T43131	TENSOR- POLEA DE DIST.	
		T43008	TENSOR- POLEA DE DIST.	
V6, 2.5 L	1997	TCK259	KIT DE DISTRIBUCION	
		TCKWP259A	KIT DE DISTRIBUCION CON B.A.	
		38042	TENSOR	
		T42018	TENSOR- POLEA DE DIST.	
		T41039	TENSOR- POLEA DE DIST.	
4 CIL. 2.0 L	1996	TCK245	KIT DE DISTRIBUCION	
		TCKWP245	KIT DE DISTRIBUCION CON B.A.	
		TCKWP245A	KIT DE DISTRIBUCION CON B.A.	
		TCKWP245B	KIT DE DISTRIBUCION CON B.A.	
		38020	TENSOR	
		38042	TENSOR	
		T41002	TENSOR- POLEA DE DIST.	
		T43132	TENSOR- POLEA DE DIST.	
		T43001	TENSOR- POLEA DE DIST.	
4 CIL. 2.4 L	1996	38020	TENSOR	
		38042	TENSOR	
		T42121	TENSOR- POLEA DE DIST.	
		T43005	TENSOR- POLEA DE DIST.	
V6, 2.5 L	1996	TCK259	KIT DE DISTRIBUCION	
		TCKWP259A	KIT DE DISTRIBUCION CON B.A.	
		38042	TENSOR	
		T42018	TENSOR- POLEA DE DIST.	
		T41039	TENSOR- POLEA DE DIST.	
4 CIL. 2.0 L	1995	TCK245	KIT DE DISTRIBUCION	
		TCKWP245	KIT DE DISTRIBUCION CON B.A.	
		38042	TENSOR	
		T41002	TENSOR- POLEA DE DIST.	
4 CIL. 2.4 L	1995	38020	TENSOR	
		38042	TENSOR	
		T42121	TENSOR- POLEA DE DIST.	
V6, 2.5 L	1995	TCK259	KIT DE DISTRIBUCION	
		TCKWP259A	KIT DE DISTRIBUCION CON B.A.	
		38042	TENSOR	
		T42018	TENSOR- POLEA DE DIST.	
		T41039	TENSOR- POLEA DE DIST.	

V10, 8.0 L	1998	38350	TENSOR	
		38350	TENSOR	
		38033	TENSOR	

## EAGLE

### 2000 GTX

4 CIL. 2.0 L (Canada)	1992	T41046	TENSOR- POLEA DE DIST.	
		T41047	TENSOR- POLEA DE DIST.	BALANCIN
		T41053	TENSOR- POLEA DE DIST.	BALANCIN
		T41043	TENSOR- POLEA DE DIST.	
4 CIL. 2.0 L (Canada)	1991	T41053	TENSOR- POLEA DE DIST.	BALANCIN
		T41047	TENSOR- POLEA DE DIST.	BALANCIN
		T41046	TENSOR- POLEA DE DIST.	
		T41043	TENSOR- POLEA DE DIST.	

### SUMMIT

4 CIL. 1.5 L	1996	T41051	TENSOR- POLEA DE DIST.	
4 CIL. 1.8 L	1996	T41052	TENSOR- POLEA DE DIST.	
4 CIL. 2.4 L	1996	T41047	TENSOR- POLEA DE DIST.	BALANCIN
4 CIL. 1.5 L	1995	T41051	TENSOR- POLEA DE DIST.	
4 CIL. 1.8 L	1995	T41052	TENSOR- POLEA DE DIST.	
4 CIL. 2.4 L	1995	T41047	TENSOR- POLEA DE DIST.	BALANCIN
4 CIL. 1.5 L	1994	T41051	TENSOR- POLEA DE DIST.	
4 CIL. 1.8 L	1994	T41052	TENSOR- POLEA DE DIST.	
4 CIL. 2.4 L	1994	T41047	TENSOR- POLEA DE DIST.	BALANCIN
4 CIL. 1.5 L	1993	T41051	TENSOR- POLEA DE DIST.	
4 CIL. 1.8 L	1993	T41052	TENSOR- POLEA DE DIST.	
4 CIL. 2.4 L	1993	T41047	TENSOR- POLEA DE DIST.	BALANCIN
4 CIL. 1.5 L	1992	T41051	TENSOR- POLEA DE DIST.	
4 CIL. 1.8 L	1992	T41052	TENSOR- POLEA DE DIST.	
4 CIL. 2.4 L	1992	T41053	TENSOR- POLEA DE DIST.	BALANCIN
4 CIL. 1.5 L	1991	T41051	TENSOR- POLEA DE DIST.	
4 CIL. 1.5 L	1990	T41042	TENSOR- POLEA DE DIST.	
4 CIL. 1.5 L	1989	T41042	TENSOR- POLEA DE DIST.	

### TALON

4 CIL. 2.0 L	1995	T41047	TENSOR- POLEA DE DIST.	BALANCIN
4 CIL. 1.8 L	1994	T41056	TENSOR- POLEA DE DIST.	
		T41057	TENSOR- POLEA DE DIST.	BALANCIN
4 CIL. 2.0 L	1994	T41047	TENSOR- POLEA DE DIST.	BALANCIN
		T41046	TENSOR- POLEA DE DIST.	(DEL TENSOR)
4 CIL. 1.8 L	1993	T41056	TENSOR- POLEA DE DIST.	
		T41057	TENSOR- POLEA DE DIST.	BALANCIN
4 CIL. 2.0 L	1993	T41047	TENSOR- POLEA DE DIST.	BALANCIN
		T41046	TENSOR- POLEA DE DIST.	(DEL TENSOR)
4 CIL. 2.0 L	1992	T41047	TENSOR- POLEA DE DIST.	BALANCIN
		T41046	TENSOR- POLEA DE DIST.	(DEL TENSOR)
4 CIL. 2.0 L	1991	T41047	TENSOR- POLEA DE DIST.	BALANCIN
		T41046	TENSOR- POLEA DE DIST.	(DEL TENSOR)
4 CIL. 2.0 L	1990	T41047	TENSOR- POLEA DE DIST.	BALANCIN
		T41046	TENSOR- POLEA DE DIST.	(DEL TENSOR)

### VISTA

4 CIL. 1.5 L (Canada)	1992	T41051	TENSOR- POLEA DE DIST.	
4 CIL. 1.5 L (Canada)	1991	T41042	TENSOR- POLEA DE DIST.	
4 CIL. 1.5 L (Canada)	1990	T41042	TENSOR- POLEA DE DIST.	
4 CIL. 1.5 L (Canada)	1989	T41042	TENSOR- POLEA DE DIST.	

## FIAT

### BRAVO

4 CIL. 1.4 L	2010	T38368	TENSOR- POLEA DE DIST.	
		T43055	TENSOR- POLEA DE DIST.	

### VIPER

V10, 8.0 L	2002	38350	TENSOR	
		38033	TENSOR	
		38350	TENSOR PARA BANDA MICRO-V	
V10, 8.0 L	2001	38350	TENSOR	
		38033	TENSOR	
V10, 8.0 L	2000	38350	TENSOR	
		38033	TENSOR	
V10, 8.0 L	1999	38033	TENSOR	

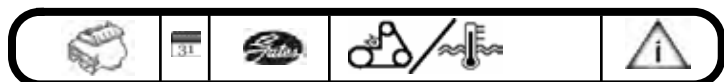

4 CIL. 1.4 L	2009	T43055 T38368	TENSOR- POLEA DE DIST. TENSOR- POLEA DE DIST.
--------------	------	------------------	--

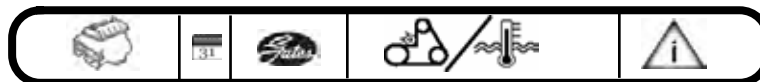

V6, 4.0 L		38102 38008 38001 38102	TENSOR TENSOR TENSOR TENSOR PARA BANDA MICRO-V
V6, 3.0 L	1996	38006 38114 38015 38002	TENSOR TENSOR TENSOR TENSOR
V6, 4.0 L	1996	38102 38001 38008	TENSOR TENSOR TENSOR
V6, 3.0 L	1995	38114 38006 38002	TENSOR TENSOR TENSOR
V6, 4.0 L	1995	38015 38134 38002	TENSOR TENSOR TENSOR
V6, 3.0 L	1994	38134 38049 38002	TENSOR PARA BANDA MICRO-V POLEA TENSOR
V6, 4.0 L	1994	38015 38049 38134	TENSOR TENSOR TENSOR
V6, 3.0 L	1993	38002 38015	TENSOR TENSOR
V6, 4.0 L	1993	38002 38134	TENSOR TENSOR

**DUCATO**

4 CIL. 2.3 L DIESEL	2010	91030 T43163 T42163	HERRAMIENTA INST. STRECH FIT TENSOR- POLEA DE DIST. TENSOR- POLEA DE DIST.
4 CIL. 3.0 L DIESEL	2010	91030	HERRAMIENTA INST. STRECH FIT
4 CIL. 2.3 L DIESEL	2009	91030 T42163 T43163	HERRAMIENTA INST. STRECH FIT TENSOR- POLEA DE DIST. TENSOR- POLEA DE DIST.
4 CIL. 3.0 L DIESEL	2009	91030	HERRAMIENTA INST. STRECH FIT
4 CIL. 2.3 L DIESEL	2008	91030 T43163 T42163	HERRAMIENTA INST. STRECH FIT TENSOR- POLEA DE DIST. TENSOR- POLEA DE DIST.
4 CIL. 3.0 L DIESEL	2008	91030	HERRAMIENTA INST. STRECH FIT

**GRANDE PUNTO**

4 CIL. 1.4 L	2010	T38368 T43055	TENSOR- POLEA DE DIST. TENSOR- POLEA DE DIST.
4 CIL. 1.4 L	2009	T38368 T43055	TENSOR- POLEA DE DIST. TENSOR- POLEA DE DIST.

**PALIO**

4 CIL. 1.8 L	2008	TPG-14004 TMV-14001	TENSOR ARBOL DE LEVAS TENSOR MICRO-V
4 CIL. 1.8 L	2007	TPG-14004 TMV-14001	TENSOR ARBOL DE LEVAS TENSOR MICRO-V
4 CIL. 1.6 L	2006	T43068 T42061 T42061 T43068	TENSOR- POLEA DE DIST. TENSOR- POLEA DE DIST. TENSOR- POLEA DE DIST. TENSOR- POLEA DE DIST.
4 CIL. 1.8 L	2006	TPG-14004 TMV-14001	TENSOR ARBOL DE LEVAS TENSOR MICRO-V
4 CIL. 1.6 L	2005	T42061 T43068	TENSOR- POLEA DE DIST. TENSOR- POLEA DE DIST.
4 CIL. 1.6 L	2004	T43068 T42061	TENSOR- POLEA DE DIST. TENSOR- POLEA DE DIST.
4 CIL. 1.6 L	2003	T42061 T43068	TENSOR- POLEA DE DIST. TENSOR- POLEA DE DIST.

**ASPIRE**

4 CIL. 1.3 L	1997	T41030	TENSOR- POLEA DE DIST.
4 CIL. 1.3 L	1996	T41030	TENSOR- POLEA DE DIST.
4 CIL. 1.3 L	1995	T41030	TENSOR- POLEA DE DIST.
4 CIL. 1.3 L	1994	T41030	TENSOR- POLEA DE DIST.

**BRONCO**

V8, 5.0 L	1996	38123	TENSOR PARA BANDA MICRO-V
V8, 5.8 L	1995	38038	POLEA
V8, 5.0 L	1983	38039	POLEA
V8, 5.8 L	1983	38039	POLEA
V8, 5.0 L	1982	38039	POLEA
V8, 5.8 L	1982	38039	POLEA
V8, 5.0 L	1981	38039	POLEA
V8, 5.8 L	1981	38039	POLEA

**PALIO ADVENTURE**

4 CIL. 1.8 L	2008	TPG-14004 TMV-14001	TENSOR ARBOL DE LEVAS TENSOR MICRO-V
4 CIL. 1.8 L	2007	TPG-14004 TMV-14001	TENSOR ARBOL DE LEVAS TENSOR MICRO-V
4 CIL. 1.6 L	2006	T42061 T43068	TENSOR- POLEA DE DIST. TENSOR- POLEA DE DIST.
4 CIL. 1.8 L	2006	TPG-14004 TMV-14001	TENSOR ARBOL DE LEVAS TENSOR MICRO-V
4 CIL. 1.6 L	2005	T42061 T43068	TENSOR- POLEA DE DIST. TENSOR- POLEA DE DIST.
4 CIL. 1.6 L	2004	T43068 T42061	TENSOR- POLEA DE DIST. TENSOR- POLEA DE DIST.
4 CIL. 1.6 L	2003	T42061 T43068	TENSOR- POLEA DE DIST. TENSOR- POLEA DE DIST.

**BRONCO FULL SIZE**

V8, 5.0 L	1986	38039	POLEA
V8, 5.0 L	1985	38039	POLEA
V8, 5.0 L	1984	38039	POLEA
V8, 5.8 L	1984	38039	POLEA

**CONTOUR**

4 CIL. 2.0 L	2000	TCK294A 38188 38018 38008 38188 T43003 T42036 T43003 T42036 T42034 T42034	KIT DE DISTRIBUCION TENSOR TENSOR TENSOR TENSOR PARA BANDA MICRO-V TENSOR- POLEA DE DIST. TENSOR- POLEA DE DIST. TENSOR- POLEA DE DIST. TENSOR- POLEA DE DIST. TENSOR- POLEA DE DIST. TENSOR- POLEA DE DIST.
V6, 2.5 L	2000	38250 38276 38006 38001 38250 38276	TENSOR TENSOR TENSOR TENSOR TENSOR PARA BANDA MICRO-V TENSOR PARA BANDA MICRO-V
4 CIL. 2.0 L	1999	TCK294 TCK294A	KIT DE DISTRIBUCION KIT DE DISTRIBUCION

**FORD**

**AEROSTAR**

V6, 3.0 L	1997	38015 38114 38006 38002 38114	TENSOR TENSOR TENSOR TENSOR TENSOR PARA BANDA MICRO-V
-----------	------	---	---



4 CIL. 2.0 L	1999	38188	TENSOR			38001	TENSOR		
		38008	TENSOR			38274	TENSOR		
		38018	TENSOR	Mar. 98 Y POST.		38006	TENSOR		
		T42036	TENSOR- POLEA DE DIST.	SUP.		38329	TENSOR		
		T43003	TENSOR- POLEA DE DIST.		V8, 4.6 L	2009	36157	POLEA	RANURADA
		T42035	TENSOR- POLEA DE DIST.	SUP.		38274	TENSOR		
		T42035	TENSOR- POLEA DE DIST.	SUP.		38001	TENSOR		
V6, 2.5 L	1999	T42034	TENSOR- POLEA DE DIST.	INF.		38329	TENSOR		
		38250	TENSOR	SERPENTIN		38006	TENSOR		
		38276	TENSOR	B. AGUA	V8, 5.4 L	2009	36157	POLEA	RANURADA
		38001	TENSOR			38001	TENSOR		
4 CIL. 2.0 L	1998	38006	TENSOR			38274	TENSOR		
		TCK294	KIT DE DISTRIBUCION			38329	TENSOR		
		38008	TENSOR			38006	TENSOR		
		38018	TENSOR	Mar. 98 Y POST.	V8, 4.6 L	2008	36157	POLEA	RANURADA
		38006	TENSOR	Feb. 98 Y ANT.		38001	TENSOR		
		38188	TENSOR			38274	TENSOR		
		T43003	TENSOR- POLEA DE DIST.			38006	TENSOR		
V6, 2.5 L	1998	T42034	TENSOR- POLEA DE DIST.	INF.		38329	TENSOR		
		T42035	TENSOR- POLEA DE DIST.	SUP.	V8, 5.4 L	2008	36157	POLEA	RANURADA
		38001	TENSOR			38006	TENSOR		
		38250	TENSOR	SERPENTIN		38274	TENSOR		
		38276	TENSOR	B. AGUA		38001	TENSOR		
4 CIL. 2.0 L	1997	38006	TENSOR			38329	TENSOR		
		TCK258	KIT DE DISTRIBUCION		V8, 5.4 L	2007	38006	TENSOR	C/AA
		38001	TENSOR			38329	TENSOR	S/AA	
		38160	TENSOR			38001	TENSOR		
		38160	TENSOR PARA BANDA MICRO-V			38274	TENSOR	C/AA	
		T42032	TENSOR- POLEA DE DIST.	IZQ.	V8, 4.6 L	2006	38274	TENSOR	C/AA
		T42032	TENSOR- POLEA DE DIST.	IZQ.		38001	TENSOR		
V6, 2.5 L	1997	T42033	TENSOR- POLEA DE DIST.	DERECHA		38329	TENSOR	S/AA	
		T42033	TENSOR- POLEA DE DIST.	DERECHA		38006	TENSOR	C/AA	
		T41008	TENSOR- POLEA DE DIST.			38274	TENSOR PARA BANDA MICRO-V	C/AA	
		T41008	TENSOR- POLEA DE DIST.			38329	TENSOR PARA BANDA MICRO-V	S/AA	
		38276	TENSOR	B. AGUA	V8, 5.4 L	2006	38329	TENSOR	S/AA
		38250	TENSOR	SERPENTIN		38274	TENSOR	C/AA	
		38006	TENSOR			38006	TENSOR	C/AA	
V6, 2.5 L	1996	38001	TENSOR			38001	TENSOR		
		38250	TENSOR	SERPENTIN	V8, 4.6 L	2005	38274	TENSOR	C/AA
		38276	TENSOR	B. AGUA		38329	TENSOR		
		38001	TENSOR			38006	TENSOR	C/AA	
4 CIL. 2.0 L	1995	38006	TENSOR			38001	TENSOR		
		TCK258	KIT DE DISTRIBUCION		V8, 5.4 L	2005	38001	TENSOR	
		38160	TENSOR			38274	TENSOR		
		38001	TENSOR			38329	TENSOR		
		T41008	TENSOR- POLEA DE DIST.			38006	TENSOR		
		T42032	TENSOR- POLEA DE DIST.	MANO IZQ.	V8, 4.6 L	2004	38274	TENSOR	C/AA
		T42033	TENSOR- POLEA DE DIST.	MANO DERECHA		38329	TENSOR	S/AA	
V6, 2.5 L	1995	38250	TENSOR	SERPENTIN		38001	TENSOR		
		38006	TENSOR	SERPENTIN		38006	TENSOR	C/AA	
					V8, 5.4 L	2004	38329	TENSOR	
<b>CROWN VICTORIA</b>						38006	TENSOR		
V8, 4.6 L	2004	38006	TENSOR			38274	TENSOR		
		38189	TENSOR		V6, 4.2 L	2003	38001	TENSOR	
		38189	TENSOR PARA BANDA MICRO-V			38007	TENSOR		
V8, 4.6 L	2003	38006	TENSOR			38138	TENSOR		
		38189	TENSOR			38009	TENSOR		
V8, 4.6 L	2002	38189	TENSOR			38001	TENSOR	C/AA	
V8, 4.6 L	2001	38189	TENSOR			38138	TENSOR PARA BANDA MICRO-V		
V8, 4.6 L	1999	38132	TENSOR	V8, 4.6 L	2003	38001	TENSOR		
		38132	TENSOR PARA BANDA MICRO-V			38274	TENSOR		
V8, 4.6 L	1996	38132	TENSOR	V8, 5.4 L	2003	38329	TENSOR		
		38006	TENSOR			38001	TENSOR		
<b>E SERIES VAN</b>						38274	TENSOR		
V8, 4.6 L	2010	36157	POLEA	RANURADA		38001	TENSOR	LISO	
		38329	TENSOR			38138	TENSOR		
		38274	TENSOR		V8, 4.6 L	2002	38009	TENSOR	
		38001	TENSOR			38007	TENSOR		
V8, 5.4 L	2010	38006	TENSOR			38001	TENSOR		
		36157	POLEA	RANURADA		38329	TENSOR		

V8, 5.4 L	2002	38001	TENSOR		V8, 4.2 L	1997	38023	TENSOR	
		38274	TENSOR				38007	TENSOR	LISO
		38022	TENSOR				38001	TENSOR	
		38023	TENSOR				38138	TENSOR	
		38133	TENSOR	C/AA			38009	TENSOR	
		38329	TENSOR		V8, 5.4 L	1997	38053	TENSOR	
V6, 4.2 L	2001	38009	TENSOR				38022	TENSOR	
		38138	TENSOR				38023	TENSOR	
		38007	TENSOR				38330	TENSOR	
		38001	TENSOR	C/AA			38133	TENSOR	
V8, 4.6 L	2001	38023	TENSOR		V8, 7.3 L	1997	38052	POLEA	
		38330	TENSOR				38119	TENSOR	
		38133	TENSOR	C/AA			38022	TENSOR	
		38022	TENSOR				38052	TENSOR	
		38053	TENSOR				38119	TENSOR PARA BANDA MICRO-V	
V8, 5.4 L	2001	38023	TENSOR		6 CIL. 4.9 L	1996	38022	POLEA	
		38022	TENSOR				38131	TENSOR	
		38330	TENSOR				38022	TENSOR	
		38133	TENSOR	C/AA			38131	TENSOR PARA BANDA MICRO-V	
		38053	TENSOR		V8, 7.5 L	1996	38140	TENSOR PARA BANDA MICRO-V	D.H.
V6, 4.2 L	2000	38138	TENSOR		6 CIL. 4.9 L	1995	38022	TENSOR	
		38007	TENSOR				38131	TENSOR	
		38001	TENSOR	C/AA			38270	TENSOR PARA BANDA MICRO-V	
		38009	TENSOR		V8, 7.3 L	1995	38270	TENSOR PARA BANDA MICRO-V	
		38133	TENSOR	C/AA	6 CIL. 4.9 L	1986	38039	POLEA	POLEA LOCA
V8, 4.6 L	2000	38133	TENSOR		V8, 5.8 L	1986	38039	POLEA	POLEA LOCA
		38053	TENSOR		6 CIL. 4.9 L	1985	38039	POLEA	POLEA LOCA
		38023	TENSOR		V8, 5.0 L	1985	38039	POLEA	POLEA LOCA
		38022	TENSOR		V8, 5.8 L	1985	38039	POLEA	POLEA LOCA
		38330	TENSOR		6 CIL. 4.9 L	1984	38039	POLEA	POLEA LOCA
V8, 5.4 L	2000	38053	TENSOR		V8, 5.0 L	1984	38039	POLEA	POLEA LOCA
		38023	TENSOR		V8, 5.8 L	1984	38039	POLEA	POLEA LOCA
		38022	TENSOR		6 CIL. 4.9 L	1983	38039	POLEA	POLEA LOCA
		38133	TENSOR	C/AA	V8, 5.0 L	1983	38039	POLEA	POLEA LOCA
		38330	TENSOR		V8, 5.8 L	1983	38039	POLEA	POLEA LOCA
V6, 4.2 L	1999	38001	TENSOR	C/AA	V8, 5.0 L	1982	38039	POLEA	POLEA LOCA
		38009	TENSOR		V8, 5.8 L	1982	38039	POLEA	POLEA LOCA
		38007	TENSOR		V8, 6.6 L	1982	38039	POLEA	POLEA LOCA
		38138	TENSOR		V8, 5.0 L	1981	38039	POLEA	POLEA LOCA
V8, 4.6 L	1999	38053	TENSOR		V8, 6.6 L	1981	38039	POLEA	POLEA LOCA
		38330	TENSOR		<b>ECOSPORT</b>				
		38023	TENSOR		4 CIL. 2.0 L	2010	38204	TENSOR	
		38022	TENSOR	C/AA			38006	TENSOR	
		38133	TENSOR		4 CIL. 2.0 L	2009	38204	TENSOR	
V8, 5.4 L	1999	38330	TENSOR				38006	TENSOR	
		38022	TENSOR	C/AA	4 CIL. 2.0 L	2008	38006	TENSOR	
		38133	TENSOR				38204	TENSOR	
		38053	TENSOR		4 CIL. 2.0 L	2007	38204	TENSOR	
V10, 6.8 L	1998	38023	POLEA	LISO			38006	TENSOR	
		38053	POLEA		4 CIL. 2.0 L	2006	38204	TENSOR	
		38022	TENSOR				38006	TENSOR	
		38133	TENSOR		4 CIL. 2.0 L	2005	38204	TENSOR	
		38023	TENSOR	LISO			38006	TENSOR	
		38053	TENSOR		4 CIL. 2.0 L	2004	38006	TENSOR	
		38330	TENSOR				38204	TENSOR	
		38330	TENSOR PARA BANDA MICRO-V		4 CIL. 2.0 L	2003	38204	TENSOR	
		38133	TENSOR PARA BANDA MICRO-V		<b>EDGE</b>				
V6, 4.2 L	1998	38138	TENSOR	LISO	V6, 3.5 L	2010	91030	HERRAMIENTA INST. STRECH FIT	
		38007	TENSOR		V6, 3.5 L	2009	91030	HERRAMIENTA INST. STRECH FIT	
		38001	TENSOR		V6, 3.5 L	2008	91030	HERRAMIENTA INST. STRECH FIT	
V8, 5.4 L	1998	38009	TENSOR		V6, 3.5 L	2007	91030	HERRAMIENTA INST. STRECH FIT	
		38133	TENSOR		<b>ESCAPE</b>				
		38022	TENSOR		4 CIL. 2.5 L	2010	38452	TENSOR	
		38053	TENSOR		4 CIL. 2.5 L	2009	38452	TENSOR	
		38330	TENSOR		CON CANALES	2009	91030	HERRAMIENTA INST. STRECH FIT	
V8, 7.3 L	1998	38023	TENSOR		V6, 3.0 L		38279	TENSOR	
		38028	POLEA	LISO			38006	TENSOR	
		38028	TENSOR	LISO	4 CIL. 2.3 L	2008	38452	TENSOR	
		38053	TENSOR	CON CANALES					
V10, 6.8 L	1997	38133	TENSOR						
		38022	TENSOR						
		38330	TENSOR						

V6, 3.0 L	2008	91030	HERRAMIENTA INST. STRECH FIT			TCK294A	KIT DE DISTRIBUCION	
		38006	SENSOR			TCKWP283A	KIT DE DISTRIBUCION CON B.A.	
4 CIL. 2.3 L	2007	38279	SENSOR			38006	SENSOR	SOHC
		38408	SENSOR			38171	SENSOR	
V6, 3.0 L	2007	38408	SENSOR PARA BANDA MICRO-V			38001	SENSOR	DOHC
		91030	HERRAMIENTA INST. STRECH FIT			38162	SENSOR	
		38276	SENSOR	B.A.		T43003	SENSOR- POLEA DE DIST.	
		38279	SENSOR			T43004	SENSOR- POLEA DE DIST.	
4 CIL. 2.3 L	2006	38408	SENSOR PARA BANDA MICRO-V			T42034	SENSOR- POLEA DE DIST.	INF.
V6, 3.0 L	2006	91030	HERRAMIENTA INST. STRECH FIT		4 CIL. 2.0 L	T42036	SENSOR- POLEA DE DIST.	SUP.
		38279	SENSOR			TCK283	KIT DE DISTRIBUCION	SOHC
4 CIL. 2.3 L	2005	38408	SENSOR			TCK294	KIT DE DISTRIBUCION	
V6, 3.0 L	2005	91030	HERRAMIENTA INST. STRECH FIT			TCK294A	KIT DE DISTRIBUCION	
		38279	SENSOR			TCKWP283A	KIT DE DISTRIBUCION CON B.A.	
		38008	SENSOR			38171	SENSOR	SOHC
V6, 3.0 L	2004	38186	SENSOR	TRANSMISIÓN DE ACC.		38006	SENSOR	DOHC
		38006	SENSOR	TRANSMISIÓN DE SERP.		38162	SENSOR	
		38276	SENSOR	B.A.		38001	SENSOR	
		38186	SENSOR PARA BANDA MICRO-V	TRANSMISIÓN DE ACC.		T42036	SENSOR- POLEA DE DIST.	SUP.
V6, 3.0 L	2003	38186	SENSOR	ACCESORIO		T43003	SENSOR- POLEA DE DIST.	
		38276	SENSOR	B. AGUA		T42034	SENSOR- POLEA DE DIST.	INF.
		38006	SENSOR	ACCESORIO		T42035	SENSOR- POLEA DE DIST.	SUP.
4 CIL. 2.0 L	2002	TCK294B	KIT DE DISTRIBUCION	ACCESORIO		T43004	SENSOR- POLEA DE DIST.	
		38008	SENSOR	SENSOR T43003	4 CIL. 2.0 L	TCK294	KIT DE DISTRIBUCION	SOHC
		38018	SENSOR			TCK283	KIT DE DISTRIBUCION	
		38188	SENSOR			TCKWP283A	KIT DE DISTRIBUCION CON B.A.	
		T42036	SENSOR- POLEA DE DIST.	SUP.		38001	SENSOR	
		T43003	SENSOR- POLEA DE DIST.			38171	SENSOR	
V6, 3.0 L	2002	T42034	SENSOR- POLEA DE DIST.	INF.		38162	SENSOR	
		38186	SENSOR	ACCESORIO		38006	SENSOR	
		38006	SENSOR	ACCESORIO		T42034	SENSOR- POLEA DE DIST.	INF.
		38276	SENSOR	B. AGUA		T43003	SENSOR- POLEA DE DIST.	
4 CIL. 2.0 L	2001	TCK294B	KIT DE DISTRIBUCION	ACCESORIO		T43004	SENSOR- POLEA DE DIST.	
		38008	SENSOR	SENSOR T43003	4 CIL. 2.0 L	T42035	SENSOR- POLEA DE DIST.	SUP.
		38188	SENSOR			TCK283	KIT DE DISTRIBUCION	SOHC
		38018	SENSOR			TCKWP283A	KIT DE DISTRIBUCION CON B.A.	
		T42034	SENSOR- POLEA DE DIST.	INF.		38001	SENSOR	
		T42036	SENSOR- POLEA DE DIST.	SUP.		38171	SENSOR	
V6, 3.0 L	2001	T43003	SENSOR- POLEA DE DIST.	ACCESORIO	4 CIL. 1.8 L	T43004	SENSOR- POLEA DE DIST.	
		38186	SENSOR	ACCESORIO		TCK179	KIT DE DISTRIBUCION	
		38006	SENSOR	ACCESORIO		T41031	SENSOR- POLEA DE DIST.	
		38276	SENSOR	B. AGUA		T42005	SENSOR- POLEA DE DIST.	
						T41031	SENSOR- POLEA DE DIST.	
						T42005	SENSOR- POLEA DE DIST.	
						TCK194	KIT DE DISTRIBUCION	
						38001	SENSOR	
						38129	SENSOR	
						38129	SENSOR PARA BANDA MICRO-V	
						T41007	SENSOR- POLEA DE DIST.	
						T41007	SENSOR- POLEA DE DIST.	
						TCKWP194	KIT DE DISTRIBUCION CON B.A.	
						TCK179	KIT DE DISTRIBUCION	
						T42005	SENSOR- POLEA DE DIST.	
						T41031	SENSOR- POLEA DE DIST.	
						TCK194	KIT DE DISTRIBUCION	
						38129	SENSOR	
						38001	SENSOR	
						T41007	SENSOR- POLEA DE DIST.	
						TCKWP194	KIT DE DISTRIBUCION CON B.A.	
						TCK179	KIT DE DISTRIBUCION	
						T41031	SENSOR- POLEA DE DIST.	
						T42005	SENSOR- POLEA DE DIST.	
						TCK194	KIT DE DISTRIBUCION	
						38001	SENSOR	
						38129	SENSOR	
						T41007	SENSOR- POLEA DE DIST.	
						TCKWP194	KIT DE DISTRIBUCION CON B.A.	
						TCKWP194	KIT DE DISTRIBUCION CON B.A.	
						TCKWP194	KIT DE DISTRIBUCION CON B.A.	
						T41006	SENSOR- POLEA DE DIST.	
						TCKWP194	KIT DE DISTRIBUCION CON B.A.	
						T41006	SENSOR- POLEA DE DIST.	

**ESCORT**

4 CIL. 2.0 L	2002	TCK294A	KIT DE DISTRIBUCION					
		TCK283	KIT DE DISTRIBUCION	SOHC				
		TCKWP283A	KIT DE DISTRIBUCION CON B.A.	DOHC				
		38006	SENSOR					
		38171	SENSOR		4 CIL. 1.9 L	1996		
		38162	SENSOR		4 CIL. 1.8 L	1995		
		38001	SENSOR					
		38171	SENSOR PARA BANDA MICRO-V					
		38162	SENSOR PARA BANDA MICRO-V		4 CIL. 1.9 L	1995		
		T43003	SENSOR- POLEA DE DIST.					
		T43004	SENSOR- POLEA DE DIST.		4 CIL. 1.9 L	1995		
		T42036	SENSOR- POLEA DE DIST.	SUP.				
		T43004	SENSOR- POLEA DE DIST.		4 CIL. 1.9 L	1995		
		T42034	SENSOR- POLEA DE DIST.	INF.	4 CIL. 1.8 L	1994		
4 CIL. 2.0 L	2001	TCK283	KIT DE DISTRIBUCION	SOHC				
		TCK294A	KIT DE DISTRIBUCION					
		TCKWP283A	KIT DE DISTRIBUCION CON B.A.		4 CIL. 1.9 L	1994		
		38001	SENSOR					
		38006	SENSOR	C/AA				
		38171	SENSOR					
		38162	SENSOR	DOHC	4 CIL. 1.9 L	1994		
		T42036	SENSOR- POLEA DE DIST.	SUP.	4 CIL. 1.9 L	1993		
		T43003	SENSOR- POLEA DE DIST.		4 CIL. 1.9 L	1992		
		T43004	SENSOR- POLEA DE DIST.		4 CIL. 1.9 L	1991		
		T42034	SENSOR- POLEA DE DIST.	INF.	4 CIL. 1.9 L	1991		
4 CIL. 2.0 L	2000	TCK283	KIT DE DISTRIBUCION	SOHC	4 CIL. 1.9 L	1990		
		TCK294	KIT DE DISTRIBUCION					

4 CIL. 1.9 L	1989	T41006	TENSOR- POLEA DE DIST.						
4 CIL. 1.9 L	1988	T41006	TENSOR- POLEA DE DIST.						
4 CIL. 1.9 L	1987	T41006	TENSOR- POLEA DE DIST.		V8, 5.4 L				
4 CIL. 2.0 L Diesel	1987	38051	POLEA	POLEA LOCA		2003	38006	TENSOR	LISO
4 CIL. 1.9 L	1986	T41006	TENSOR- POLEA DE DIST.						
4 CIL. 2.0 L Diesel	1986	38051	POLEA	POLEA LOCA	V8, 4.6 L	2002	38022	TENSOR	
4 CIL. 1.6 L	1985	T41006	TENSOR- POLEA DE DIST.						
4 CIL. 1.9 L	1985	T41006	TENSOR- POLEA DE DIST.						C/AA
4 CIL. 2.0 L Diesel	1985	38051	POLEA	POLEA LOCA			38023	TENSOR	LISA
4 CIL. 1.6 L	1984	T41006	TENSOR- POLEA DE DIST.		V8, 5.4 L	2002	38133	TENSOR	C/AA
4 CIL. 1.6 L	1983	T41006	TENSOR- POLEA DE DIST.				38022	TENSOR	
4 CIL. 1.6 L	1982	T41006	TENSOR- POLEA DE DIST.				38274	TENSOR	
4 CIL. 1.6 L	1981	T41006	TENSOR- POLEA DE DIST.				38023	TENSOR	LISA

**EXCURSION**

V10, 6.8 L	2005	38022	TENSOR		V8, 5.4 L	2001	38023	TENSOR	LISA
		38274	TENSOR				38133	TENSOR	C/AA
V8, 6.0 L	2005	38257	TENSOR PARA BANDA MICRO-V				38133	TENSOR	LISO
V10, 6.8 L	2004	38274	TENSOR		V8, 4.6 L	2000	38022	TENSOR	C/AA
		38022	TENSOR				38133	TENSOR	LISO
V10, 6.8 L	2003	38274	TENSOR				38022	TENSOR	
		38133	TENSOR	C/AA	V8, 5.4 L	2000	38023	TENSOR	LISA
		38022	TENSOR				38133	TENSOR	
V8, 4.6 L	2003	38001	TENSOR	LISA			38023	TENSOR	
V8, 7.3 L	2003	38191	TENSOR PARA BANDA MICRO-V		V8, 4.6 L	1999	38022	TENSOR	LISA
V10, 6.8 L	2002	38022	TENSOR				38023	TENSOR	
		38274	TENSOR		V8, 5.4 L	1999	38133	TENSOR	C/AA
		38023	TENSOR	LISA			38023	TENSOR	LISO
		38133	TENSOR	C/AA			38022	TENSOR	
V10, 6.8 L	2001	38133	TENSOR		V8, 4.6 L	1998	38133	TENSOR	LISO
		38022	TENSOR				38023	TENSOR	
		38023	TENSOR	LISO			38022	TENSOR	
V8, 5.4 L	2001	38023	TENSOR		V8, 5.4 L	1998	38133	TENSOR	LISO
		38022	TENSOR				38022	TENSOR	
		38133	TENSOR	C/AA			38023	TENSOR	
V10, 6.8 L	2000	38022	TENSOR		V8, 4.6 L	1997	38022	TENSOR	LISA
		38133	TENSOR				38023	TENSOR	
		38023	TENSOR	LISO			38133	TENSOR	
V8, 5.4 L	2000	38133	TENSOR		V8, 5.4 L	1997	38023	TENSOR	
		38023	TENSOR				38133	TENSOR	

**EXPEDITION**

V8, 5.4 L	2010	36157	POLEA	RANURADA
		38274	TENSOR	
		38001	TENSOR	LISA
		38006	TENSOR	
V8, 5.4 L	2009	36157	POLEA	RANURADA
		38274	TENSOR	
		38006	TENSOR	
		38001	TENSOR	LISA
V8, 5.4 L	2008	36157	POLEA	RANURADA
		38001	TENSOR	LISA
		38006	TENSOR	
		38274	TENSOR	
V8, 5.4 L	2007	36157	POLEA	RANURADA
		38001	TENSOR	LISA
		38274	TENSOR	
		38006	TENSOR	
V8, 5.4 L	2006	36157	POLEA	RANURADA
		38274	TENSOR	
		38006	TENSOR	
		38001	TENSOR	LISA
V8, 5.4 L	2005	36157	POLEA	RANURADA
		38001	TENSOR	LISA
		38274	TENSOR	
		38006	TENSOR	
V8, 4.6 L	2004	38274	TENSOR	
		38001	TENSOR	LISA
V8, 5.4 L	2004	38274	TENSOR	
V8, 4.6 L	2003	38006	TENSOR	

**EXPLORER**

V6, 4.0 L	2010	38137	TENSOR	
		38001	TENSOR	
V8, 4.6 L	2010	36157	POLEA	RANURADA
		38006	TENSOR	
		38001	TENSOR	LISA
		38274	TENSOR	
V6, 4.0 L	2009	38008	TENSOR	
		38001	TENSOR	
		38137	TENSOR	
V8, 4.6 L	2009	36157	POLEA	RANURADA
		38006	TENSOR	
		38001	TENSOR	LISA
		38274	TENSOR	
V6, 4.0 L	2008	38008	TENSOR	
		38137	TENSOR	
		38001	TENSOR	
V8, 4.6 L	2008	36157	POLEA	RANURADA
		38006	TENSOR	
		38001	TENSOR	LISA
		38274	TENSOR	
V6, 4.0 L	2007	38001	TENSOR	
		38001	TENSOR	
		38008	TENSOR	
		38137	TENSOR	
		38137	TENSOR	
		38137	TENSOR PARA BANDA MICRO-V	
V8, 4.6 L	2007	36157	POLEA	RANURADA

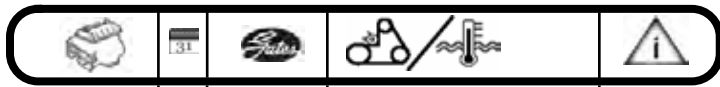

V8, 4.6 L	2007	38001	SENSOR	LISA
		38274	SENSOR	
		38001	SENSOR	
		38274	SENSOR	
		38006	SENSOR	
		38006	SENSOR	
V6, 4.0 L	2006	38001	SENSOR	
		38137	SENSOR	
V8, 4.6 L	2006	38274	SENSOR	
		38006	SENSOR	
		38001	SENSOR	
V6, 4.0 L	2005	38137	SENSOR	
		38001	SENSOR	
V8, 4.6 L	2005	38274	SENSOR	
		38006	SENSOR	
		38001	SENSOR	
V6, 4.0 L	2004	38001	SENSOR	
		38137	SENSOR	
V8, 4.6 L	2004	38001	SENSOR	LISO
		38006	SENSOR	
		38274	SENSOR	
V6, 4.0 L	2003	38001	SENSOR	
		38137	SENSOR	
		38008	SENSOR	
V8, 4.6 L	2003	38022	SENSOR	LISA
		38274	SENSOR	
		38006	SENSOR	
		38001	SENSOR	LISO
V6, 4.0 L	2002	38137	SENSOR	
		38001	SENSOR	
		38008	SENSOR	
V8, 4.6 L	2002	38022	SENSOR	LISA
		38274	SENSOR	
		38001	SENSOR	LISO
V6, 4.0 L	2001	38137	SENSOR	
		38001	SENSOR	
		38008	SENSOR	
V8, 5.0 L	2001	38008	SENSOR	CON CANALES
		38001	SENSOR	LISO
		38161	SENSOR	
		38002	SENSOR	
		38006	SENSOR	
		38161	SENSOR PARA BANDA MICRO-V	
V6, 4.0 L	2000	38001	SENSOR	
		38008	SENSOR	
		38102	SENSOR	
		38137	SENSOR	
V8, 5.0 L	2000	38002	SENSOR	
		38001	SENSOR	LISO
		38008	SENSOR	CON CANALES
		38161	SENSOR	
		38006	SENSOR	
V6, 4.0 L	1999	38008	SENSOR	
		38102	SENSOR	
		38001	SENSOR	
V8, 5.0 L	1999	38161	SENSOR	
		38008	SENSOR	CON CANALES
		38001	SENSOR	LISO
		38002	SENSOR	
		38006	SENSOR	
V6, 4.0 L	1998	38008	SENSOR	
		38102	SENSOR	
		38001	SENSOR	
V8, 5.0 L	1998	38002	SENSOR	
		38001	SENSOR	LISO
		38161	SENSOR	
		38008	SENSOR	CON CANALES
		38006	SENSOR	
V6, 4.0 L	1997	38001	SENSOR	
		38102	SENSOR	
		38008	SENSOR	
V6, 4.0 L	1996	38008	SENSOR	



V6, 4.0 L	1995	38001	SENSOR	
		38102	SENSOR	
		38001	SENSOR	
		38102	SENSOR	
		38008	SENSOR	

**EXPLORER SPORT TRAC**

V6, 4.0 L	2010	38137	SENSOR	
		38001	SENSOR	
V8, 4.6 L	2010	36157	POLEA	RANURADA
		38006	SENSOR	
		38001	SENSOR	LISA
		38274	SENSOR	
V6, 4.0 L	2009	38137	SENSOR	
		38008	SENSOR	
		38001	SENSOR	
V8, 4.6 L	2009	36157	POLEA	RANURADA
		38001	SENSOR	LISA
		38006	SENSOR	
V6, 4.0 L	2008	38008	SENSOR	
		38137	SENSOR	
		38001	SENSOR	
V8, 4.6 L	2008	36157	POLEA	RANURADA
		38274	SENSOR	
		38001	SENSOR	LISA
		38006	SENSOR	
V6, 4.0 L	2007	38008	SENSOR	
		38137	SENSOR	
		38001	SENSOR	
V8, 4.6 L	2007	36157	POLEA	RANURADA
		38006	SENSOR	
		38001	SENSOR	LISA
		38274	SENSOR	
V6, 4.0 L	2006	38001	SENSOR	
		38137	SENSOR	
V6, 4.0 L	2005	38137	SENSOR	
		38001	SENSOR	
V6, 4.0 L	2004	38001	SENSOR	
		38137	SENSOR	
V6, 4.0 L	2003	38137	SENSOR	
		38001	SENSOR	
V6, 4.0 L	2002	38137	SENSOR	
		38001	SENSOR	
V6, 4.0 L	2001	38001	SENSOR	
		38008	SENSOR	
		38137	SENSOR	

**F SERIES PICKUP**

V6, 4.2 L	2002	38138	SENSOR	LISO
		38001	SENSOR	
		38009	SENSOR	
		38007	SENSOR	
V8, 5.4 L	2002	38274	SENSOR	ACCESORIO
		38023	SENSOR	
		38329	SENSOR	ACCESORIO
		38133	SENSOR	C/AA
		38022	SENSOR	
		38001	SENSOR	ACCESORIO (LISO)
V6, 4.2 L	2001	38007	SENSOR	
		38009	SENSOR	
		38138	SENSOR	
		38001	SENSOR	C/AA
V8, 4.6 L	2001	38133	SENSOR	C/AA
		38330	SENSOR	
		38053	SENSOR	
		38023	SENSOR	
		38022	SENSOR	
V8, 5.4 L	2001	38022	SENSOR	C/AA
		38133	SENSOR	C/AA
		38023	SENSOR	C/AA



V8, 5.4 L	2001	38330	SENSOR	
		38053	SENSOR	
V10, 6.8 L	2000	38133	SENSOR	
		38023	SENSOR	
		38022	SENSOR	
V6, 4.2 L	2000	38138	SENSOR	
		38009	SENSOR	
		38007	SENSOR	
		38001	SENSOR	C/AA
V8, 4.6 L	2000	38330	SENSOR	
		38022	SENSOR	
		38023	SENSOR	
		38053	SENSOR	
		38133	SENSOR	C/AA
V8, 5.4 L	2000	38023	SENSOR	C/AA
		38133	SENSOR	C/AA
		38022	SENSOR	C/AA
		38330	SENSOR	
		38053	SENSOR	
V10, 6.8 L	1999	38133	SENSOR	
		38022	SENSOR	
		38023	SENSOR	
V6, 4.2 L	1999	38009	SENSOR	
		38007	SENSOR	C/AA
		38001	SENSOR	
		38138	SENSOR	
V8, 4.6 L	1999	38023	SENSOR	
		38022	SENSOR	
		38330	SENSOR	
		38133	SENSOR	C/AA
		38053	SENSOR	
V8, 5.4 L	1999	38330	SENSOR	
		38133	SENSOR	C/AA
		38053	SENSOR	
		38023	SENSOR	C/AA
		38022	SENSOR	C/AA
V6, 4.2 L	1998	38009	SENSOR	
		38007	SENSOR	
		38001	SENSOR	LISO
		38138	SENSOR	
V8, 4.6 L	1998	38022	SENSOR	
		38023	SENSOR	
		38133	SENSOR	C/AA
		38053	SENSOR	
		38330	SENSOR	
V8, 5.8 L	1997	38123	SENSOR	
		38006	SENSOR	
		38007	SENSOR	C/ALT 60 A
V8, 7.5 L	1997	38140	SENSOR	
		38001	SENSOR	
6 CIL. 4.9 L	1996	38012	POLEA	
V6, 4.9 L	1996	38131	SENSOR	
		38022	SENSOR	
V8, 5.0 L	1996	38123	SENSOR	C/AA DE FABRICA
		38007	SENSOR	C/ALT 60 A
		38015	SENSOR	C/AA DE FABRICA
		38006	SENSOR	C/AA DE FABRICA
V8, 5.8 L	1996	38006	SENSOR	
		38015	SENSOR	
		38123	SENSOR	
		38007	SENSOR	C/ALT 60 A
V6, 4.9 L	1995	38022	SENSOR	
		38131	SENSOR	
V8, 5.0 L	1995	38007	SENSOR	C/ALT 60 A
		38006	SENSOR	C/AA DE FABRICA
		38123	SENSOR	C/AA DE FABRICA
		38015	SENSOR	C/AA DE FABRICA
V8, 5.8 L	1995	38006	SENSOR	C/ALT 60 A
		38015	SENSOR	
		38123	SENSOR	C/AA DE FABRICA
		38007	SENSOR	C/ALT 60 A
V8, 5.0 L	1992	38115	SENSOR PARA BANDA MICRO-V	C/AA DE FABRICA

6 CIL. 4.9 L	1986	38039	POLEA	POLEA LOCA
V8, 5.0 L	1986	38039	POLEA	POLEA LOCA
V8, 5.8 L	1986	38039	POLEA	POLEA LOCA
6 CIL. 4.9 L	1985	38039	POLEA	POLEA LOCA
V8, 5.0 L	1985	38039	POLEA	POLEA LOCA
V8, 5.8 L	1985	38039	POLEA	POLEA LOCA
6 CIL. 4.9 L	1984	38039	POLEA	POLEA LOCA
V8, 5.0 L	1984	38039	POLEA	POLEA LOCA
V8, 5.8 L	1984	38039	POLEA	POLEA LOCA
6 CIL. 4.9 L	1983	38039	POLEA	POLEA LOCA
V8, 5.0 L	1983	38039	POLEA	POLEA LOCA
V8, 5.8 L	1983	38039	POLEA	POLEA LOCA
V8, 5.0 L	1982	38039	POLEA	POLEA LOCA
V8, 5.8 L	1982	38039	POLEA	POLEA LOCA
V8, 6.6 L	1982	38039	POLEA	POLEA LOCA
V8, 5.0 L	1981	38039	POLEA	POLEA LOCA
V8, 5.8 L	1981	38039	POLEA	POLEA LOCA
V8, 6.6 L	1981	38039	POLEA	POLEA LOCA

**F-150**

V8, 4.6 L	2010	36157	POLEA	RANURADA
		38001	SENSOR	LISA
		38274	SENSOR	CON A.A.
V8, 4.6 L	2009	36157	POLEA	RANURADA
		38274	SENSOR	CON A.A.
		38001	SENSOR	LISA
V6, 4.2 L	2008	38138	SENSOR	
		38001	SENSOR	
V8, 4.6 L	2008	36157	POLEA	RANURADA
		38001	SENSOR	LISA
		38329	SENSOR	SIN A.A.
		38274	SENSOR	CON A.A.
V6, 4.2 L	2007	38138	SENSOR	
		38007	SENSOR	
V6, 4.2 L	2006	38009	SENSOR	S/AA
		38138	SENSOR	
		38291	SENSOR	S/AA
		38001	SENSOR	
V8, 4.6 L	2005	38009	SENSOR	
		38001	SENSOR	
		38291	SENSOR	S/AA
		38007	SENSOR	
V6, 4.2 L	2004	38138	SENSOR	
		38007	SENSOR	
		38001	SENSOR	
		38009	SENSOR	S/AA
		38138	SENSOR	
		38291	SENSOR	S/AA
V6, 4.2 L	2003	38291	SENSOR	S/AA
		38001	SENSOR	
		38009	SENSOR	S/AA
		38007	SENSOR	
V6, 4.2 L	2002	38138	SENSOR	
		38007	SENSOR	
V6, 4.2 L	2001	38007	SENSOR	
		38138	SENSOR	
V6, 4.2 L	2000	38007	SENSOR	
		38138	SENSOR	
V6, 4.2 L	1999	38007	SENSOR	
		38138	SENSOR	
V6, 4.2 L	1998	38007	SENSOR	
		38138	SENSOR	
V6, 4.9 L	1996	38022	SENSOR	
		38131	SENSOR	
V6, 4.9 L	1995	38022	SENSOR	
		38131	SENSOR	

**F-250**



V8, 4.6 L	2007	38329	SENSOR	S/AA		38274	TENSOR		CON A.A.
		38274	TENSOR	C/AA		38329	TENSOR		SIN A.A.
V8, 4.6 L	2006	38329	TENSOR	S/AA		38001	TENSOR		
		38274	TENSOR	C/AA	V8, 5.4 L	36157	POLEA		RANURADA
V8, 4.6 L	2005	38274	TENSOR	C/AA		38329	TENSOR		
		38329	TENSOR	S/AA		38274	TENSOR		
V8, 4.6 L	2004	38329	TENSOR	S/AA		38001	TENSOR		LISA
		38274	TENSOR	C/AA		38001	TENSOR		
		38023	TENSOR	C/AA	V8, 5.4 L	36157	POLEA		RANURADA
		38022	TENSOR			38001	TENSOR		LISA
		38053	TENSOR	S/AA		38329	TENSOR		
V8, 4.6 L	2003	38023	TENSOR	C/AA		38001	TENSOR		
		38274	TENSOR	C/AA		38274	TENSOR		
		38329	TENSOR	S/AA	V8, 5.4 L	36157	POLEA		RANURADA
		38022	TENSOR			38001	TENSOR		LISA
		38053	TENSOR	S/AA		38001	TENSOR		
V8, 4.6 L	2002	38053	TENSOR	S/AA		38329	TENSOR		
		38023	TENSOR	C/AA		38274	TENSOR		
		38022	TENSOR		V8, 5.4 L	38023	TENSOR		
		38329	TENSOR	S/AA		38022	TENSOR		
		38274	TENSOR	C/AA		38133	TENSOR		C/AA
V8, 4.6 L	2001	38330	TENSOR	S/AA		38330	TENSOR		S/AA
		38022	TENSOR			38001	TENSOR		
		38133	TENSOR	C/AA	V8, 5.4 L	38023	TENSOR		
		38053	TENSOR	S/AA		38022	TENSOR		
		38023	TENSOR	C/AA		38001	TENSOR		
V8, 4.6 L	2000	38330	TENSOR	S/AA		38330	TENSOR		S/AA
		38133	TENSOR	C/AA		38133	TENSOR		C/AA
		38053	TENSOR	S/AA	V8, 5.4 L	38133	TENSOR		C/AA
		38023	TENSOR			38001	TENSOR		
		38022	TENSOR			38022	TENSOR		
V8, 4.6 L	1999	38330	TENSOR	S/AA		38330	TENSOR		S/AA
		38053	TENSOR	S/AA		38274	TENSOR		
		38133	TENSOR	C/AA	V8, 5.4 L	38274	TENSOR		
		38023	TENSOR			38001	TENSOR		
		38022	TENSOR			38022	TENSOR		
V8, 4.6 L	1998	38022	TENSOR			38133	TENSOR		C/AA
		38023	TENSOR			38330	TENSOR		S/AA
		38330	TENSOR	S/AA	V8, 5.4 L	38133	TENSOR		C/AA
		38133	TENSOR	C/AA		38330	TENSOR		S/AA
		38053	TENSOR	S/AA		38001	TENSOR		
V8, 5.0 L	1996	38007	TENSOR	C/ALT 60 A		38022	TENSOR		
		38123	TENSOR	C/AA DE FABRICA		38274	TENSOR		
		38015	TENSOR	C/AA DE FABRICA	V8, 5.4 L	38133	TENSOR		C/AA
		38006	TENSOR	C/ALT 60 A		38023	TENSOR		
V8, 5.0 L	1995	38007	TENSOR	C/ALT 60 A		38022	TENSOR		
		38006	TENSOR	C/ALT 60 A	V8, 5.4 L	38133	TENSOR		C/AA
		38015	TENSOR	C/AA DE FABRICA		38023	TENSOR		
		38123	TENSOR	C/AA DE FABRICA		38022	TENSOR		
V8, 5.0 L	1994	38006	TENSOR	C/ALT 60 A	V8, 5.4 L	38133	TENSOR		C/AA
		38015	TENSOR	C/AA DE FABRICA		38022	TENSOR		
		38007	TENSOR	C/ALT 60 A		38023	TENSOR		
		38123	TENSOR	C/ALT 60 A	V8, 5.8 L	38123	TENSOR		
V8, 5.0 L	1993	38015	TENSOR	C/AA DE FABRICA		38006	TENSOR		
		38007	TENSOR	C/ALT 60 A		38007	TENSOR		C/ALT 60 A
		38006	TENSOR	C/ALT 60 A	V8, 5.0 L	38123	TENSOR		C/ALT 60 A
		38123	TENSOR	C/ALT 60 A		38007	TENSOR		C/ALT 60 A
						38006	TENSOR		C/ALT 60 A
						38015	TENSOR		C/AA DE FABRICA
						38006	TENSOR		
						38007	TENSOR		C/ALT 60 A
						38123	TENSOR		
						38006	TENSOR		C/ALT 60 A
						38007	TENSOR		C/ALT 60 A
						38015	TENSOR		C/AA DE FABRICA
						38123	TENSOR		C/ALT 60 A
						38006	TENSOR		C/ALT 60 A
						38007	TENSOR		C/ALT 60 A
						38015	TENSOR		C/AA DE FABRICA
						38123	TENSOR		C/ALT 60 A
						38006	TENSOR		C/ALT 60 A
						38007	TENSOR		C/ALT 60 A
						38123	TENSOR		C/ALT 60 A
<b>F-250 SUPER DUTY</b>									
V8, 6.4 L DIESEL	2010	36234	POLEA	LISA		38006	TENSOR		C/ALT 60 A
		39052	TENSOR			38007	TENSOR		C/ALT 60 A
		39051	TENSOR			38123	TENSOR		C/ALT 60 A
V8, 6.4 L DIESEL	2009	36234	POLEA	LISA	V8, 5.0 L	38006	TENSOR		C/ALT 60 A
		39051	TENSOR			38123	TENSOR		C/ALT 60 A
		39052	TENSOR			38007	TENSOR		C/ALT 60 A
V8, 6.4 L DIESEL	2008	36234	POLEA	LISA	V8, 5.8 L	38015	TENSOR		C/AA DE FABRICA
		39052	TENSOR			38123	TENSOR		C/ALT 60 A
		39051	TENSOR			38006	TENSOR		C/ALT 60 A
						38007	TENSOR		C/ALT 60 A
						38015	TENSOR		C/AA DE FABRICA
						38123	TENSOR		C/ALT 60 A
						38006	TENSOR		C/ALT 60 A
						38007	TENSOR		C/ALT 60 A
						38015	TENSOR		C/AA DE FABRICA
						38123	TENSOR		C/ALT 60 A
						38006	TENSOR		C/ALT 60 A
						38007	TENSOR		C/ALT 60 A
						38123	TENSOR		C/ALT 60 A
<b>F-350 SUPER DUTY</b>									
V8, 5.4 L	2010	38006	TENSOR			38123	TENSOR		C/ALT 60 A

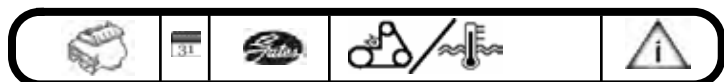

V8, 5.0 L	1994	38006	TENSOR	C/ALT 60 A
V8, 5.8 L	1994	38006	TENSOR	C/ALT 60 A
		38007	TENSOR	C/ALT 60 A
		38123	TENSOR	C/ALT 60 A
V8, 5.0 L	1993	38015	TENSOR	C/AA DE FABRICA
		38123	TENSOR	C/ALT 60 A
		38006	TENSOR	C/ALT 60 A
		38007	TENSOR	C/ALT 60 A
V8, 5.8 L	1993	38007	TENSOR	C/ALT 60 A
		38123	TENSOR	C/ALT 60 A
		38006	TENSOR	C/ALT 60 A

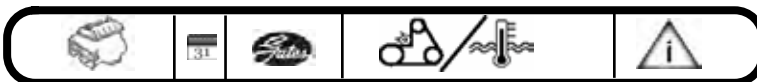

**F-550 SUPER DUTY**

V10, 6.8 L	2010	38001	TENSOR	SIN A.A.
		38329	TENSOR	
		38006	TENSOR	CON A.A.
		38274	TENSOR	LISA
V8, 6.4 L DIESEL	2010	36234	POLEA	
		39052	TENSOR	
		39051	TENSOR	
V10, 6.8 L	2009	38329	TENSOR	SIN A.A.
		38006	TENSOR	
		38274	TENSOR	CON A.A.
		38001	TENSOR	
V8, 6.4 L DIESEL	2009	36234	POLEA	LISA
		39051	TENSOR	
		39052	TENSOR	
V10, 6.8 L	2008	38329	TENSOR	SIN A.A.
		38274	TENSOR	CON A.A.
		38001	TENSOR	
		38006	TENSOR	
V8, 6.4 L DIESEL	2008	36234	POLEA	LISA
		39051	TENSOR	
		39052	TENSOR	

**F-450 SUPER DUTY**

V10, 6.8 L	2010	38329	TENSOR	SIN A.A.
		38006	TENSOR	
		38274	TENSOR	CON A.A.
		38001	TENSOR	
V8, 6.4 L DIESEL	2010	36234	POLEA	LISA
		39052	TENSOR	
		39051	TENSOR	
V10, 6.8 L	2009	38329	TENSOR	SIN A.A.
		38006	TENSOR	
		38001	TENSOR	
		38274	TENSOR	CON A.A.
V8, 6.4 L DIESEL	2009	36234	POLEA	LISA
		39051	TENSOR	
		39052	TENSOR	
V10, 6.8 L	2008	38001	TENSOR	SIN A.A.
		38329	TENSOR	CON A.A.
		38274	TENSOR	
		38006	TENSOR	
V8, 6.4 L DIESEL	2008	36234	POLEA	LISA
		39051	TENSOR	
		39052	TENSOR	
V10, 6.8 L	2007	36157	POLEA	RANURADA
		38274	TENSOR	
		38329	TENSOR	
		38001	TENSOR	LISA
		38001	TENSOR	
V10, 6.8 L	2006	38133	TENSOR	
		38023	TENSOR	
		38022	TENSOR	
V10, 6.8 L	2005	38023	TENSOR	
		38133	TENSOR	
		38022	TENSOR	
V10, 6.8 L	2004	38023	TENSOR	
		38022	TENSOR	
		38133	TENSOR	
V10, 6.8 L	2003	38022	TENSOR	
		38133	TENSOR	
V8, 7.3 L	2003	38023	TENSOR	
		38028	TENSOR	
		38053	TENSOR	LISA
		38191	TENSOR	
V10, 6.8 L	2002	38023	TENSOR	
		38022	TENSOR	
		38133	TENSOR	
V8, 7.3 L	2002	38053	TENSOR	LISA
		38028	TENSOR	
		38191	TENSOR	
V10, 6.8 L	2001	38133	TENSOR	
		38023	TENSOR	
		38022	TENSOR	
V10, 6.8 L	2000	38022	TENSOR	
		38133	TENSOR	
		38023	TENSOR	
V10, 6.8 L	1999	38023	TENSOR	
		38133	TENSOR	
		38022	TENSOR	
V8, 7.5 L	1997	38001	TENSOR	
		38140	TENSOR	

**FESTIVA**

4 CIL. 1.3 L	1993	T41030	TENSOR- POLEA DE DIST.
		T41030	TENSOR- POLEA DE DIST.
4 CIL. 1.3 L	1992	T41030	TENSOR- POLEA DE DIST.
		T41030	TENSOR- POLEA DE DIST.
4 CIL. 1.3 L	1991	T41030	TENSOR- POLEA DE DIST.
4 CIL. 1.3 L	1990	T41030	TENSOR- POLEA DE DIST.
4 CIL. 1.3 L	1989	T41030	TENSOR- POLEA DE DIST.
4 CIL. 1.3 L	1988	T41030	TENSOR- POLEA DE DIST.

**FIESTA**

4 CIL. 1.6 L	2010	TMV13001	TENSOR MICRO-V
4 CIL. 1.6 L	2009	TMV13001	TENSOR MICRO-V
4 CIL. 1.6 L	2008	TMV13001	TENSOR MICRO-V
4 CIL. 1.6 L	2007	TMV13001	TENSOR MICRO-V
4 CIL. 1.6 L	2006	TMV13001	TENSOR MICRO-V
4 CIL. 1.6 L	2005	TMV13001	TENSOR MICRO-V
4 CIL. 1.6 L	2004	TMV13001	TENSOR MICRO-V
4 CIL. 1.6 L	2003	TMV13001	TENSOR MICRO-V
4 CIL. 1.6 L	2002	TMV13001	TENSOR MICRO-V
4 CIL. 1.6 L	2001	TMV13001	TENSOR MICRO-V
4 CIL. 1.6 L	2000	TMV13001	TENSOR MICRO-V

**FIVE HUNDRED**

V6, 3.0 L	2007	38279	TENSOR
V6, 3.0 L	2006	38279	TENSOR
V6, 3.0 L	2005	38279	TENSOR

**FOCUS**

4 CIL. 2.0 L	2010	38452	TENSOR
4 CIL. 2.0 L	2009	38452	TENSOR
4 CIL. 2.0 L	2008	38452	TENSOR
4 CIL. 2.0 L	2007	38452	TENSOR
4 CIL. 2.0 L	2006	TCK294A	KIT DE DISTRIBUCION
4 CIL. 2.0 L	2005	TCK294A	KIT DE DISTRIBUCION
4 CIL. 2.0 L	2004	TCK283	KIT DE DISTRIBUCION
		TCK294A	KIT DE DISTRIBUCION
		TCKWP283	KIT DE DISTRIBUCION CON B.A.
		38275	TENSOR
		38275	TENSOR PARA BANDA MICRO-V
		T42036	TENSOR- POLEA DE DIST.
		T42034	TENSOR- POLEA DE DIST.
		T43004	TENSOR- POLEA DE DIST.
		T43003	TENSOR- POLEA DE DIST.
4 CIL. 2.0 L	2003	TCK294A	KIT DE DISTRIBUCION



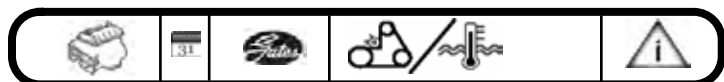

4 CIL. 2.0 L	2003	TCK283	KIT DE DISTRIBUCION	SOCH
		TCKWP283	KIT DE DISTRIBUCION CON B.A.	
		38188	ENSOR	
		38275	ENSOR	
		38008	ENSOR	
		T42034	ENSOR- POLEA DE DIST.	INF.
		T43004	ENSOR- POLEA DE DIST.	
		T42036	ENSOR- POLEA DE DIST.	SUP.
		T43003	ENSOR- POLEA DE DIST.	
4 CIL. 2.0 L	2002	TCK283	KIT DE DISTRIBUCION	SOCH
		TCK294A	KIT DE DISTRIBUCION	
		TCKWP283	KIT DE DISTRIBUCION CON B.A.	
		38018	ENSOR	DOHC
		38275	ENSOR	
		38008	ENSOR	
		38188	ENSOR	
		T42034	ENSOR- POLEA DE DIST.	INF.
		T43004	ENSOR- POLEA DE DIST.	
		T43003	ENSOR- POLEA DE DIST.	
		T42036	ENSOR- POLEA DE DIST.	SUP.
4 CIL. 2.0 L	2001	TCK283	KIT DE DISTRIBUCION	SOCH
		TCK294A	KIT DE DISTRIBUCION	
		TCKWP283	KIT DE DISTRIBUCION CON B.A.	
		38008	ENSOR	
		38188	ENSOR	
		38018	ENSOR	DOHC
		38275	ENSOR	
		T42036	ENSOR- POLEA DE DIST.	SUP.
		T43004	ENSOR- POLEA DE DIST.	
		T42034	ENSOR- POLEA DE DIST.	INF.
		T43003	ENSOR- POLEA DE DIST.	
4 CIL. 2.0 L	2000	TCK294A	KIT DE DISTRIBUCION	
		TCK283	KIT DE DISTRIBUCION	SOCH
		TCKWP283	KIT DE DISTRIBUCION CON B.A.	
		38275	ENSOR	
		38008	ENSOR	
		38188	ENSOR	
		38018	ENSOR	DOHC
		T42034	ENSOR- POLEA DE DIST.	INF.
		T42036	ENSOR- POLEA DE DIST.	SUP.
		T43003	ENSOR- POLEA DE DIST.	
		T43004	ENSOR- POLEA DE DIST.	



**IKON**

4 CIL. 1.6 L	2007	TMV13001	ENSOR MICRO-V	
4 CIL. 1.6 L	2006	TMV-13001	ENSOR MICRO-V	
4 CIL. 1.6 L	2005	TMV-13001	ENSOR MICRO-V	
		TMV-13001	ENSOR MICRO-V	
4 CIL. 1.6 L	2004	TMV-13001	ENSOR MICRO-V	
4 CIL. 1.6 L	2003	TMV-13001	ENSOR MICRO-V	
4 CIL. 1.6 L	2002	TMV-13001	ENSOR MICRO-V	
4 CIL. 1.6 L	2001	TMV-13001	ENSOR MICRO-V	
4 CIL. 1.6 L	2000	TMV-13001	ENSOR MICRO-V	

**KA**

4 CIL. 1.6 L	2007	TMV13001	ENSOR MICRO-V	
4 CIL. 1.6 L	2006	TMV13001	ENSOR MICRO-V	
4 CIL. 1.6 L	2005	36136	OLEA	
		36136	OLEA	
		TMV-13001	ENSOR MICRO-V	
4 CIL. 1.6 L	2004	TMV-13001	ENSOR MICRO-V	
4 CIL. 1.6 L	2003	TMV-13001	ENSOR MICRO-V	
4 CIL. 1.6 L	2002	TMV-13001	ENSOR MICRO-V	
4 CIL. 1.6 L	2001	TMV-13001	ENSOR MICRO-V	

**LOBO**

V8, 4.6 L	2010	36157	OLEA	RANURADA
		38001	ENSOR	LISA
		38274	ENSOR	CON A.A.
V8, 5.4 L	2010	36157	OLEA	RANURADA
		38274	ENSOR	CON A.A.
		38001	ENSOR	LISA
V8, 4.6 L	2009	36157	OLEA	RANURADA
		38001	ENSOR	LISA
		38274	ENSOR	CON A.A.
V8, 5.4 L	2009	36157	OLEA	RANURADA
		38001	ENSOR	LISA
		38274	ENSOR	CON A.A.
V8, 4.6 L	2008	36157	OLEA	RANURADA
		38329	ENSOR	SIN A.A.
		38274	ENSOR	CON A.A.
V8, 5.4 L	2008	36157	OLEA	LISA
		38001	ENSOR	RANURADA
		38329	ENSOR	LISA
		38274	ENSOR	SIN A.A.
V8, 4.6 L	2007	38274	ENSOR	CON A.A.
		38329	ENSOR	C/AA
V8, 5.4 L	2007	36157	OLEA	S/AA
		38329	ENSOR	RANURADA
		38001	ENSOR	S/AA
		38274	ENSOR	LISA
V8, 4.6 L	2006	36157	OLEA	C/AA
		36157	OLEA	RANURADA
		38001	ENSOR	RANURADA
		38329	ENSOR	LISA
		38274	ENSOR	S/AA
V8, 5.4 L	2006	36157	OLEA	C/AA
		38274	ENSOR	RANURADA
		38001	ENSOR	C/AA
		38329	ENSOR	LISA
V8, 4.6 L	2005	36157	OLEA	S/AA
		38329	ENSOR	RANURADA
		38274	ENSOR	C/AA
V8, 5.4 L	2005	36157	OLEA	LISA
		38274	ENSOR	RANURADA
		38001	ENSOR	LISA
V8, 4.6 L	2002	38274	ENSOR	S/AA
V8, 5.4 L	2002	38022	ENSOR	A.A.
		38133	ENSOR	C/AA

**FREESTAR**

V6, 3.9 L	2005	38150	ENSOR	
		38150	ENSOR PARA BANDA MICRO-V	
V6, 4.2 L	2005	38150	ENSOR	
V6, 3.9 L	2004	38150	ENSOR	
V6, 4.2 L	2004	38150	ENSOR	

**FUSION**

4 CIL. 2.5 L	2010	38452	ENSOR	
V6, 3.5 L	2010	91030	HERRAMIENTA INST. STRECH FIT	
4 CIL. 2.3 L	2009	38339	ENSOR	T. MANUAL
		38452	ENSOR	T. AUTOMATICA
V6, 3.0 L	2009	91030	HERRAMIENTA INST. STRECH FIT	
		38006	ENSOR	LISA
		38008	ENSOR	RANURADA
		38279	ENSOR	
4 CIL. 2.3 L	2008	38339	ENSOR	T. MANUAL
		38452	ENSOR	T. AUTOMATICA
V6, 3.0 L	2008	91030	HERRAMIENTA INST. STRECH FIT	
		38279	ENSOR	
		38006	ENSOR	
		38008	ENSOR	
4 CIL. 2.3 L	2007	38452	ENSOR	T. AUTOMATICA
		38339	ENSOR	T. MANUAL
V6, 3.0 L	2007	91030	HERRAMIENTA INST. STRECH FIT	
		38006	ENSOR	
		38008	ENSOR	
		38279	ENSOR	



V8, 5.4 L | 2002 | 38023 | TENSOR | LISA



V8, 4.6 L | 1998 | 38029 | TENSOR

**MONDEO**

4 CIL. 2.0 L	2006	38204	TENSOR	
		38204	TENSOR PARA BANDA MICRO-V	
4 CIL. 2.0 L	2005	38204	TENSOR	
4 CIL. 2.0 L	2004	38204	TENSOR	
4 CIL. 2.0 L	2003	38204	TENSOR	

**MUSTANG**

V6, 4.0 L	2010	38416	TENSOR	
		38001	TENSOR	
V8, 4.6 L	2010	36157	POLEA	RANURADA
		38001	TENSOR	LISA
		38006	TENSOR	
		38274	TENSOR	
V6, 4.0 L	2009	38001	TENSOR	
		38416	TENSOR	
V8, 4.6 L	2009	36157	POLEA	RANURADA
		38001	TENSOR	LISA
		38006	TENSOR	
		38274	TENSOR	
V6, 4.0 L	2008	38001	TENSOR	
		38416	TENSOR	
V8, 4.6 L	2008	36157	POLEA	RANURADA
		38001	TENSOR	LISA
		38274	TENSOR	
		38006	TENSOR	
V6, 4.0 L	2007	38001	TENSOR	
V8, 4.6 L	2007	36157	POLEA	
		38001	TENSOR	2PIEZAS
		38274	TENSOR	
V6, 4.0 L	2006	38001	TENSOR	
V8, 4.6 L	2006	36157	POLEA	
		38001	TENSOR	
		38274	TENSOR	
V6, 4.0 L	2005	38001	TENSOR	
V8, 4.6 L	2005	38001	TENSOR	LOCA
		38274	TENSOR	
V8, 4.6 L	2004	36100	POLEA	CON CANALES
		38189	TENSOR	
V6, 3.8 L	2003	38127	TENSOR PARA BANDA MICRO-V	
V8, 4.6 L	2003	36100	POLEA	CON CANALES
		38001	TENSOR	ACCESORIO
		38189	TENSOR	ACCESORIO
V8, 4.6 L	2002	36100	POLEA	CON CANALES
		38006	TENSOR	LISO
		38189	TENSOR	
V6, 3.8 L	2001	38006	TENSOR	
		38127	TENSOR	
		38009	TENSOR	
V8, 4.6 L	2001	36100	POLEA	CON CANALES
		38006	TENSOR	LISO
		38189	TENSOR	
V6, 3.8 L	2000	38029	POLEA	
		38029	TENSOR	
		38006	TENSOR	
		38009	TENSOR	
		38127	TENSOR	
V8, 4.6 L	2000	36100	POLEA	CON CANALES
		38189	TENSOR	
		38006	TENSOR	
V6, 3.8 L	1999	38006	TENSOR	
		38009	TENSOR	
		38029	TENSOR	
		38127	TENSOR	
V8, 4.6 L	1999	38132	TENSOR	
		38006	TENSOR	
V6, 3.8 L	1998	38006	TENSOR	
		38009	TENSOR	
		38022	TENSOR	

V8, 4.6 L	1998	38006	TENSOR	
		38132	TENSOR	
V6, 3.8 L	1997	38022	TENSOR	
		38127	TENSOR	
		38029	TENSOR	
		38009	TENSOR	
V8, 4.6 L	1997	38132	TENSOR	
		38006	TENSOR	
V6, 3.8 L	1996	38127	TENSOR	
		38029	TENSOR	
		38022	TENSOR	
		38009	TENSOR	
V8, 4.6 L	1996	38132	TENSOR	
		38006	TENSOR	
V8, 5.0 L	1995	38182	TENSOR	
		38006	TENSOR	
		38182	TENSOR PARA BANDA MICRO-V	
V8, 5.0 L	1994	38006	TENSOR	
		38182	TENSOR	
4 CIL. 2.3 L	1993	38142	TENSOR PARA BANDA MICRO-V	SERP.
		38141	TENSOR PARA BANDA MICRO-V	B.A.
4 CIL. 2.3 L	1992	38142	TENSOR PARA BANDA MICRO-V	SERP.
		38141	TENSOR PARA BANDA MICRO-V	B.A.
4 CIL. 2.3 L	1991	38142	TENSOR PARA BANDA MICRO-V	SERP.
		38141	TENSOR PARA BANDA MICRO-V	B.A.
4 CIL. 2.3 L	1990	38141	TENSOR PARA BANDA MICRO-V	B.A.
		38142	TENSOR PARA BANDA MICRO-V	SERP.
4 CIL. 2.3 L	1989	38142	TENSOR PARA BANDA MICRO-V	SERP.
		38141	TENSOR PARA BANDA MICRO-V	B.A.
4 CIL. 2.3 L	1988	38141	TENSOR PARA BANDA MICRO-V	B.A.
		38142	TENSOR PARA BANDA MICRO-V	SERP.
4 CIL. 2.3 L	1987	38142	TENSOR PARA BANDA MICRO-V	SERP.
		38141	TENSOR PARA BANDA MICRO-V	B.A.
4 CIL. 2.3 L	1986	38035	POLEA	POLEA LOCA
4 CIL. 2.3 L	1985	38035	POLEA	POLEA LOCA
V6, 3.8 L	1985	38050	POLEA	POLEA LOCA
V8, 5.0 L	1985	38039	POLEA	POLEA LOCA
V8, 5.0 L	1984	38039	POLEA	POLEA LOCA
		38121	TENSOR PARA BANDA MICRO-V	

**MUSTANG SHELBY**

V8, 5.4 L	2010	38385	TENSOR	SUPER CARGADO
V8, 5.4 L	2009	38385	TENSOR	SUPER CARGADO

**PROBE**

4 CIL. 2.0 L	1997	T41091	TENSOR- POLEA DE DIST.	
		T41091	TENSOR- POLEA DE DIST.	
		T42008	TENSOR- POLEA DE DIST.	POLEA LOCA
		T42008	TENSOR- POLEA DE DIST.	POLEA TENSORA
V6, 2.5 L	1997	T42010	TENSOR- POLEA DE DIST.	POLEA LOCA SUP.
		T43114	TENSOR- POLEA DE DIST.	HIDRAULICO
		T42010	TENSOR- POLEA DE DIST.	POLEA TENSORA
		T42009	TENSOR- POLEA DE DIST.	POLEA TENSORA
		T42009	TENSOR- POLEA DE DIST.	POLEA LOCA INF.
		T41034	TENSOR- POLEA DE DIST.	POLEA
		T41034	TENSOR- POLEA DE DIST.	(DEL TENSOR)
4 CIL. 2.0 L	1996	T42008	TENSOR- POLEA DE DIST.	POLEA LOCA
		T41091	TENSOR- POLEA DE DIST.	
		T41091	TENSOR- POLEA DE DIST.	
		T42008	TENSOR- POLEA DE DIST.	POLEA TENSORA
V6, 2.5 L	1996	T42010	TENSOR- POLEA DE DIST.	POLEA TENSORA
		T42010	TENSOR- POLEA DE DIST.	POLEA LOCA SUP.
		T43114	TENSOR- POLEA DE DIST.	HIDRAULICO
		T42009	TENSOR- POLEA DE DIST.	POLEA TENSORA
		T41034	TENSOR- POLEA DE DIST.	(DEL TENSOR)
		T41034	TENSOR- POLEA DE DIST.	POLEA
		T42009	TENSOR- POLEA DE DIST.	POLEA LOCA INF.
4 CIL. 2.0 L	1995	T41091	TENSOR- POLEA DE DIST.	
		T42008	TENSOR- POLEA DE DIST.	POLEA LOCA



4 CIL. 2.0 L	1995	T42008	TENSOR- POLEA DE DIST.	POLEA TENSORA			T41005	TENSOR- POLEA DE DIST.	
		T41091	TENSOR- POLEA DE DIST.		V6, 3.0 L	2001	38006	TENSOR	
V6, 2.5 L	1995	T43114	TENSOR- POLEA DE DIST.	HIDRAULICO			38114	TENSOR	
		T42009	TENSOR- POLEA DE DIST.	POLEA LOCA INF.			38001	TENSOR	
		T42010	TENSOR- POLEA DE DIST.	POLEA TENSORA	V6, 4.0 L	2001	38001	TENSOR	
		T42010	TENSOR- POLEA DE DIST.	POLEA LOCA SUP.			38137	TENSOR	
		T42009	TENSOR- POLEA DE DIST.	POLEA TENSORA			38008	TENSOR	
		T41034	TENSOR- POLEA DE DIST.	POLEA	4 CIL. 2.5 L	2000	TCK276	KIT DE DISTRIBUCION	
		T41034	TENSOR- POLEA DE DIST.	(DEL TENSOR)			38155	TENSOR	
4 CIL. 2.0 L	1994	T42008	TENSOR- POLEA DE DIST.	POLEA TENSORA			38001	TENSOR	
		T42008	TENSOR- POLEA DE DIST.	POLEA LOCA			38006	TENSOR	
		T41091	TENSOR- POLEA DE DIST.				T41005	TENSOR- POLEA DE DIST.	
		T41091	TENSOR- POLEA DE DIST.		V6, 3.0 L	2000	38006	TENSOR	
V6, 2.5 L	1994	T42009	TENSOR- POLEA DE DIST.	POLEA TENSORA			38114	TENSOR	
		T43114	TENSOR- POLEA DE DIST.	HIDRAULICO			38001	TENSOR	
		T41034	TENSOR- POLEA DE DIST.	(DEL TENSOR)	V6, 4.0 L	2000	38008	TENSOR	
		T41034	TENSOR- POLEA DE DIST.	POLEA			38102	TENSOR	
		T42009	TENSOR- POLEA DE DIST.	POLEA LOCA INF.			38001	TENSOR	
		T42010	TENSOR- POLEA DE DIST.	POLEA TENSORA	4 CIL. 2.5 L	1999	TCK276	KIT DE DISTRIBUCION	
		T42010	TENSOR- POLEA DE DIST.	POLEA LOCA SUP.			38001	TENSOR	
4 CIL. 2.0 L	1993	T42008	TENSOR- POLEA DE DIST.	POLEA LOCA			38155	TENSOR	
		T41091	TENSOR- POLEA DE DIST.				38006	TENSOR	
		T42008	TENSOR- POLEA DE DIST.	POLEA TENSORA	V6, 3.0 L	1999	T41005	TENSOR- POLEA DE DIST.	
		T41091	TENSOR- POLEA DE DIST.				38114	TENSOR	
V6, 2.5 L	1993	T42009	TENSOR- POLEA DE DIST.	POLEA LOCA INF.			38001	TENSOR	
		T43114	TENSOR- POLEA DE DIST.	HIDRAULICO	V6, 4.0 L	1999	38006	TENSOR	
		T42009	TENSOR- POLEA DE DIST.	POLEA TENSORA			38008	TENSOR	
		T42010	TENSOR- POLEA DE DIST.	POLEA TENSORA			38102	TENSOR	
		T42010	TENSOR- POLEA DE DIST.	POLEA LOCA SUP.			38001	TENSOR	
		T41034	TENSOR- POLEA DE DIST.	POLEA	4 CIL. 2.5 L	1998	TCK276	KIT DE DISTRIBUCION	
		T41034	TENSOR- POLEA DE DIST.	(DEL TENSOR)			38001	TENSOR	
4 CIL. 2.2 L	1992	T41029	TENSOR- POLEA DE DIST.	POLEA LOCA			38155	TENSOR	
		T42003	TENSOR- POLEA DE DIST.	POLEA TENSORA			38006	TENSOR	
		T42003	TENSOR- POLEA DE DIST.		V6, 3.0 L	1998	T41005	TENSOR- POLEA DE DIST.	
		T41029	TENSOR- POLEA DE DIST.				38114	TENSOR	
4 CIL. 2.2 L	1991	T41029	TENSOR- POLEA DE DIST.				38006	TENSOR	
		T42003	TENSOR- POLEA DE DIST.	POLEA LOCA	4 CIL. 2.3 L	1997	TCK276	KIT DE DISTRIBUCION	
4 CIL. 2.2 L	1990	T41029	TENSOR- POLEA DE DIST.				38009	TENSOR	C/AA
		T42003	TENSOR- POLEA DE DIST.	POLEA LOCA			38155	TENSOR	
4 CIL. 2.2 L	1989	T41029	TENSOR- POLEA DE DIST.				38006	TENSOR	
		T42003	TENSOR- POLEA DE DIST.	POLEA LOCA	4 CIL. 2.3 L	1996	TCK276	KIT DE DISTRIBUCION	
							38155	TENSOR	
							38009	TENSOR	C/AA
							38006	TENSOR	
					V6, 3.0 L	1996	T41005	TENSOR- POLEA DE DIST.	
							38006	TENSOR	
					4 CIL. 2.3 L	1995	TCK276	KIT DE DISTRIBUCION	
							38006	TENSOR	
							38009	TENSOR	
							38155	TENSOR	
					4 CIL. 2.3 L	1983	T41005	TENSOR- POLEA DE DIST.	
							38039	POLEA	POLEA LOCA
<b>RANGER</b>									
4 CIL. 2.3 L	2010	38155	TENSOR						
4 CIL. 2.3 L	2009	38155	TENSOR						
4 CIL. 2.3 L	2008	38155	TENSOR						
4 CIL. 2.3 L	2007	38155	TENSOR		V6, 3.0 L				
		38155	TENSOR PARA BANDA MICRO-V						
4 CIL. 2.3 L	2006	38155	TENSOR		4 CIL. 2.3 L	1995	TCK276	KIT DE DISTRIBUCION	
4 CIL. 2.3 L	2005	38155	TENSOR				38006	TENSOR	
4 CIL. 2.3 L	2004	38155	TENSOR				38009	TENSOR	
		38001	TENSOR	C/AA			38155	TENSOR	
		38006	TENSOR				T41005	TENSOR- POLEA DE DIST.	
4 CIL. 2.3 L	2003	38006	TENSOR		4 CIL. 2.3 L	1983	38039	POLEA	POLEA LOCA
		38155	TENSOR						
		38001	TENSOR	C/AA					
4 CIL. 2.3 L	2002	TCK276	KIT DE DISTRIBUCION	C/AA	V10, 6.8 L	2003	38274	TENSOR	
		38001	TENSOR	C/AA			38329	TENSOR	
		38155	TENSOR		V8, 5.4 L	2003	38274	TENSOR	
		38006	TENSOR				38329	TENSOR	
V6, 3.0 L	2002	38006	TENSOR				38001	TENSOR	LISO
		38001	TENSOR		V10, 6.8 L	2002	38133	TENSOR	C/AA
		38114	TENSOR				38022	TENSOR	
4 CIL. 2.3 L	2001	TCK276	KIT DE DISTRIBUCION				38274	TENSOR	
		38006	TENSOR				38329	TENSOR	
		38155	TENSOR				38023	TENSOR	LISA
		T41005	TENSOR- POLEA DE DIST.		V8, 5.4 L	2002	38023	TENSOR	LISA
		T41005	TENSOR- POLEA DE DIST.				38022	TENSOR	
4 CIL. 2.5 L	2001	TCK276	KIT DE DISTRIBUCION				38274	TENSOR	
		38006	TENSOR				38133	TENSOR	C/AA
		38155	TENSOR				38329	TENSOR	
		38001	TENSOR				38001	TENSOR	LISO
<b>SUPER DUTY PICKUP</b>									

V8, 7.3 L	2002	38028	TENSOR	LISO			
		38023	TENSOR	LISA			
		38191	TENSOR				
		38053	TENSOR	CON CANALES			
V8, 5.4 L	2001	38053	TENSOR				
		38023	TENSOR				
		38330	TENSOR				
		38133	TENSOR	C/AA			
		38022	TENSOR				
V8, 7.3 L	2001	38023	TENSOR				
		38191	TENSOR				
		38053	TENSOR	CON CANALES			
		38028	TENSOR	LISO			
V10, 6.8 L	2000	38133	TENSOR	C/AA			
		38330	TENSOR				
		38023	TENSOR	LISO			
		38022	TENSOR				
		38022	TENSOR				
V8, 5.4 L	2000	38133	TENSOR	C/AA			
		38053	TENSOR				
		38022	TENSOR				
		38330	TENSOR				
		38023	TENSOR				
V8, 7.3 L	2000	38023	TENSOR	LISO			
		38028	TENSOR				
		38191	TENSOR				
		38053	TENSOR	CON CANALES			
V10, 6.8 L	1999	38022	TENSOR				
		38022	TENSOR				
		38133	TENSOR	C/AA			
		38023	TENSOR				
		38330	TENSOR				
V8, 5.4 L	1999	38330	TENSOR				
		38022	TENSOR				
		38023	TENSOR				
		38053	TENSOR				
		38133	TENSOR	C/AA			
V8, 7.3 L	1999	38023	TENSOR				
		38028	TENSOR	LISO			
		38053	TENSOR				
		38191	TENSOR	CON CANALES			

V8, 5.4 L		38023	TENSOR				
		38022	TENSOR				
		38133	TENSOR				C/AA
		38330	TENSOR				
		38053	TENSOR				
V8, 7.3 L	2000	38028	TENSOR	LISO			
		38053	TENSOR	CON CANALES			
		38023	TENSOR				
V10, 6.8 L	1999	38330	TENSOR				
		38133	TENSOR				
		38022	TENSOR				
		38023	TENSOR				
V8, 5.4 L	1999	38133	TENSOR				
		38330	TENSOR				
		38023	TENSOR				
		38053	TENSOR				
		38022	TENSOR				
V8, 7.3 L	1999	38023	TENSOR				
		38028	TENSOR				
		38053	TENSOR				
		38022	TENSOR				

**TAURUS**

V6, 3.0 L	2000	38181	TENSOR PARA BANDA MICRO-V				
V6, 3.0 L	1995	T41205	TENSOR- POLEA DE DIST.				
V6, 3.0 L	1994	T41205	TENSOR- POLEA DE DIST.				
V6, 3.0 L	1993	T41205	TENSOR- POLEA DE DIST.				
V6, 3.8 L	1993	38139	TENSOR PARA BANDA MICRO-V				
V6, 3.0 L	1992	38125	TENSOR PARA BANDA MICRO-V				
		T41205	TENSOR- POLEA DE DIST.				
V6, 3.0 L	1991	38125	TENSOR PARA BANDA MICRO-V				
V6, 3.0 L	1990	38125	TENSOR PARA BANDA MICRO-V				
V6, 3.0 L	1989	38125	TENSOR PARA BANDA MICRO-V				
V6, 3.0 L	1988	38125	TENSOR PARA BANDA MICRO-V				

**TEMPO**

4 CIL. 2.0 L Diesel	1986	38051	POLEA	POLEA LOCA
4 CIL. 2.0 L Diesel	1985	38051	POLEA	POLEA LOCA

**THUNDERBIRD**

V8, 4.6 L	1997	38132	TENSOR				
		38006	TENSOR				
V8, 4.6 L	1996	38006	TENSOR				
		38132	TENSOR				
V6, 3.8 L	1995	38298	TENSOR PARA BANDA MICRO-V				
		38299	TENSOR PARA BANDA MICRO-V				
		38297	TENSOR PARA BANDA MICRO-V				
V8, 4.6 L	1995	38132	TENSOR				
		38006	TENSOR				
V6, 3.8 L	1994	38007	TENSOR				
		38299	TENSOR				
		38127	TENSOR				
		38001	TENSOR				
		38006	TENSOR				LISO
		38297	TENSOR				
		38023	TENSOR				
		38298	TENSOR				
		38009	TENSOR				
V8, 4.6 L	1994	38132	TENSOR				
		38006	TENSOR				
4 CIL. 2.3 L	1988	38142	TENSOR PARA BANDA MICRO-V	SERP.			
		38141	TENSOR PARA BANDA MICRO-V				
4 CIL. 2.3 L	1987	38142	TENSOR PARA BANDA MICRO-V	SERP.			
		38141	TENSOR PARA BANDA MICRO-V	B.A			
V6, 3.8 L	1987	38050	POLEA	POLEA LOCA			
V6, 3.8 L	1986	38050	POLEA	POLEA LOCA			
V6, 3.8 L	1985	38050	POLEA	POLEA LOCA			
V8, 5.0 L	1981	38039	POLEA	POLEA LOCA			

**TOPAZ**

4 CIL. 2.3 L	1994	38006	TENSOR	
--------------	------	-------	--------	--

**SUPER DUTY VAN**

V8, 4.6 L	2003	38022	TENSOR	Lisa, C/Supercargador			
		38001	TENSOR				
		38329	TENSOR				
		38274	TENSOR				
V10, 6.8 L	2002	38329	TENSOR				
		38274	TENSOR				
V8, 5.4 L	2002	38274	TENSOR				
		38329	TENSOR				
V10, 6.8 L	2001	38133	TENSOR	C/AA			
		38053	TENSOR				
		38023	TENSOR				
		38330	TENSOR				
		38022	TENSOR				
V6, 4.2 L	2001	38138	TENSOR				
		38007	TENSOR				
		38001	TENSOR	C/AA			
V8, 5.4 L	2001	38022	TENSOR				
		38023	TENSOR				
		38330	TENSOR				
		38133	TENSOR				
		38053	TENSOR				
V8, 7.3 L	2001	38023	TENSOR				
		38028	TENSOR	LISO			
		38053	TENSOR	CON CANALES			
V10, 6.8 L	2000	38022	TENSOR				
		38023	TENSOR				
		38133	TENSOR	C/AA			
		38330	TENSOR				
		38053	TENSOR				

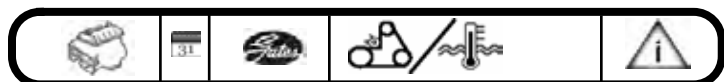

4 CIL. 2.3 L	1994	38032 38168 38168	TENSOR TENSOR TENSOR PARA BANDA MICRO-V	
4 CIL. 2.3 L	1991	38117	TENSOR PARA BANDA MICRO-V	



4 CIL. 1.3 L	1995	T41009	TENSOR- POLEA DE DIST.	
3 CIL. 1.0 L	1994	T41065 T41009 T41009	TENSOR- POLEA DE DIST. TENSOR- POLEA DE DIST. TENSOR- POLEA DE DIST.	
3 CIL. 1.0 L	1993	T41009 T41009	TENSOR- POLEA DE DIST. TENSOR- POLEA DE DIST.	
3 CIL. 1.0 L	1992	T41009 T41009	TENSOR- POLEA DE DIST. TENSOR- POLEA DE DIST.	
3 CIL. 1.0 L	1991	T41009	TENSOR- POLEA DE DIST.	
3 CIL. 1.0 L	1990	T41009	TENSOR- POLEA DE DIST.	
3 CIL. 1.0 L	1989	T41009	TENSOR- POLEA DE DIST.	

**TRANSIT**

4 CIL. 2.2 L	2010	91030 T36124	HERRAMIENTA INST. STRECH FIT TENSOR- POLEA DE DIST.	A.A.
4 CIL. 2.2 L	2009	91030 T36124	HERRAMIENTA INST. STRECH FIT TENSOR- POLEA DE DIST.	A.A.
4 CIL. 2.2 L	2008	91030 T36124	HERRAMIENTA INST. STRECH FIT TENSOR- POLEA DE DIST.	A.A.

**WINDSTAR**

V6, 3.8 L	2003	38001 38008 38150	TENSOR TENSOR TENSOR	
V6, 3.8 L	2002	38008 38001 38150	TENSOR TENSOR TENSOR	
V6, 3.8 L	2001	38008 38150 38001	TENSOR TENSOR TENSOR	
V6, 3.8 L	2000	38150 38001 38008	TENSOR TENSOR TENSOR	
V6, 3.8 L	1999	38008 38001 38150	TENSOR TENSOR TENSOR	
V6, 3.0 L	1998	38006 38005 38114	TENSOR TENSOR TENSOR	
V6, 3.8 L	1998	38139 38008 38009	TENSOR TENSOR TENSOR	
V6, 3.8 L	1997	38001 38005 38139	TENSOR TENSOR TENSOR	
V6, 3.8 L	1996	38009 38139 38005	TENSOR TENSOR TENSOR	
V6, 3.8 L	1995	38009 38139 38023 38009 38006	TENSOR TENSOR TENSOR TENSOR TENSOR	

**ZX2**

4 CIL. 2.0 L	2003	TCK294A 38162 38006 T43003 T42036 T42034	KIT DE DISTRIBUCION TENSOR TENSOR TENSOR- POLEA DE DIST. TENSOR- POLEA DE DIST. TENSOR- POLEA DE DIST.	SUP. INF.
4 CIL. 2.0 L	2002	38162	TENSOR	
4 CIL. 2.0 L	2001	38162	TENSOR	

**GEO**

**METRO**

3 CIL. 1.0 L	1997	T41010 T41010	TENSOR- POLEA DE DIST. TENSOR- POLEA DE DIST.	
4 CIL. 1.3 L	1997	T41065	TENSOR- POLEA DE DIST.	
3 CIL. 1.0 L	1996	T41010 T41010	TENSOR- POLEA DE DIST. TENSOR- POLEA DE DIST.	
4 CIL. 1.3 L	1996	T41065	TENSOR- POLEA DE DIST.	
3 CIL. 1.0 L	1995	T41009	TENSOR- POLEA DE DIST.	

**PRIZM**

4 CIL. 1.6 L	1997	T41072 T41072	TENSOR- POLEA DE DIST. TENSOR- POLEA DE DIST.	
4 CIL. 1.8 L	1997	T41072 T41072	TENSOR- POLEA DE DIST. TENSOR- POLEA DE DIST.	
4 CIL. 1.6 L	1996	T41072 T41072	TENSOR- POLEA DE DIST. TENSOR- POLEA DE DIST.	
4 CIL. 1.8 L	1996	T41072 T41072	TENSOR- POLEA DE DIST. TENSOR- POLEA DE DIST.	
4 CIL. 1.6 L	1995	T41072 T41072	TENSOR- POLEA DE DIST. TENSOR- POLEA DE DIST.	
4 CIL. 1.8 L	1995	T41072 T41072	TENSOR- POLEA DE DIST. TENSOR- POLEA DE DIST.	
4 CIL. 1.6 L	1994	T41072 T41072	TENSOR- POLEA DE DIST. TENSOR- POLEA DE DIST.	
4 CIL. 1.8 L	1994	T41072 T41072	TENSOR- POLEA DE DIST. TENSOR- POLEA DE DIST.	
4 CIL. 1.6 L	1993	T41072 T41072	TENSOR- POLEA DE DIST. TENSOR- POLEA DE DIST.	
4 CIL. 1.8 L	1993	T41072 T41072	TENSOR- POLEA DE DIST. TENSOR- POLEA DE DIST.	
4 CIL. 1.6 L	1992	T41066 T41066	TENSOR- POLEA DE DIST. TENSOR- POLEA DE DIST.	
4 CIL. 1.6 L	1991	T41066	TENSOR- POLEA DE DIST.	
4 CIL. 1.6 L	1990	T41066	TENSOR- POLEA DE DIST.	
4 CIL. 1.6 L	1989	T41066	TENSOR- POLEA DE DIST.	

**STORM**

4 CIL. 1.6 L	1993	T41202	TENSOR- POLEA DE DIST.	
4 CIL. 1.6 L	1992	T41202	TENSOR- POLEA DE DIST.	
4 CIL. 1.6 L	1991	T42001 T41027 T41202	TENSOR- POLEA DE DIST. TENSOR- POLEA DE DIST. TENSOR- POLEA DE DIST.	POLEA LOCA
4 CIL. 1.6 L	1990	T41202 T41027 T42001	TENSOR- POLEA DE DIST. TENSOR- POLEA DE DIST. TENSOR- POLEA DE DIST.	POLEA LOCA

**TRACKER**

4 CIL. 1.6 L	1997	T41065	TENSOR- POLEA DE DIST.	
4 CIL. 1.6 L	1996	T41065	TENSOR- POLEA DE DIST.	
4 CIL. 1.6 L	1995	T41064 T41065	TENSOR- POLEA DE DIST. TENSOR- POLEA DE DIST.	
4 CIL. 1.6 L	1994	T41064 T41065	TENSOR- POLEA DE DIST. TENSOR- POLEA DE DIST.	
4 CIL. 1.6 L	1993	T41064	TENSOR- POLEA DE DIST.	
4 CIL. 1.6 L	1992	T41064	TENSOR- POLEA DE DIST.	

**GMC**

**ACADIA**

V6, 3.6 L	2010	38397	TENSOR	
V6, 3.6 L	2009	38397	TENSOR	
V6, 3.6 L	2008	38397	TENSOR	
V6, 3.6 L	2007	38397	TENSOR	

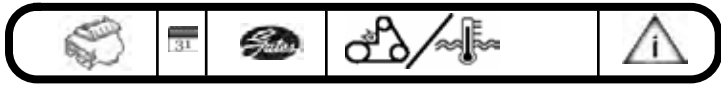

**C & K SERIES PICKUP**

V8, 6.5 L Diesel	1995	38267	TENSOR PARA BANDA MICRO-V	
V8, 6.5 L Diesel	1994	38267	TENSOR PARA BANDA MICRO-V	
V8, 6.2 L Diesel	1993	38267	TENSOR PARA BANDA MICRO-V	
V8, 6.5 L Diesel	1993	38267	TENSOR PARA BANDA MICRO-V	
V8, 6.2 L Diesel	1992	38267	TENSOR PARA BANDA MICRO-V	
V8, 6.5 L Diesel	1992	38267	TENSOR PARA BANDA MICRO-V	
V8, 6.2 L Diesel	1991	38267	TENSOR PARA BANDA MICRO-V	
V8, 6.2 L Diesel	1990	38267	TENSOR PARA BANDA MICRO-V	
V8, 6.2 L Diesel	1989	38267	TENSOR PARA BANDA MICRO-V	
V8, 6.2 L Diesel	1988	38267	TENSOR PARA BANDA MICRO-V	

V6, 4.3 L	2004	38103	TENSOR PARA BANDA MICRO-V	CANADA
		38001	POLEA	LISO CANADA
		38008	POLEA	CANADA
		38103	TENSOR PARA BANDA MICRO-V	CANADA
V6, 4.3 L	2003	38001	POLEA	LISO CANADA
		38008	POLEA	CANADA
		38103	TENSOR PARA BANDA MICRO-V	CANADA
V6, 4.3 L	2002	38001	POLEA	LISO CANADA
		38008	POLEA	CANADA
		38103	TENSOR PARA BANDA MICRO-V	CANADA
V6, 4.3 L	2001	38001	POLEA	LISO
		38008	POLEA	
		38103	TENSOR PARA BANDA MICRO-V	
V6, 4.3 L	2000	38008	POLEA	
		38001	POLEA	
		38103	TENSOR PARA BANDA MICRO-V	

**CANYON**

5 CIL. 3.7 L	2010	36101	POLEA	
		36301	POLEA	
		38178	TENSOR	
5 CIL. 3.7 L	2009	36301	POLEA	
		36101	POLEA	
		38178	TENSOR	
5 CIL. 3.7 L	2008	36101	POLEA	
		38178	TENSOR	
4 CIL. 2.9 L	2007	36101	POLEA	
		38178	TENSOR	
5 CIL. 3.7 L	2007	36101	POLEA	
		38178	TENSOR	

**SAFARI**

V6, 4.3 L	2005	38008	POLEA	
		38001	POLEA	LISO
		38103	TENSOR PARA BANDA MICRO-V	
V6, 4.3 L	2004	38008	POLEA	
		38001	POLEA	LISO
		38103	TENSOR PARA BANDA MICRO-V	
V6, 4.3 L	2003	38001	POLEA	LISO
		38008	POLEA	
		38103	TENSOR PARA BANDA MICRO-V	
V6, 4.3 L	2002	38008	POLEA	
		38001	POLEA	LISO
		38103	TENSOR PARA BANDA MICRO-V	
V6, 4.3 L	2001	38008	POLEA	
		38001	POLEA	LISO
		38103	TENSOR PARA BANDA MICRO-V	
V6, 4.3 L	2000	38008	POLEA	
		38001	POLEA	LISO
		38103	TENSOR PARA BANDA MICRO-V	

**ENVOY**

6 CIL. 4.2 L	2007	38006	POLEA	
		36101	POLEA	
		38178	TENSOR PARA BANDA MICRO-V	
V8, 5.3 L	2007	38009	POLEA	SERPENTIN
		38001	POLEA	SERPENTIN
		38158	TENSOR PARA BANDA MICRO-V	SERPENTIN
		38159	TENSOR PARA BANDA MICRO-V	A.A.
6 CIL. 4.2 L	2006	38006	POLEA	
		36101	POLEA	
		38178	TENSOR PARA BANDA MICRO-V	
V8, 5.3 L	2006	38009	POLEA	SERPENTIN
		38001	POLEA	SERPENTIN
		38158	TENSOR PARA BANDA MICRO-V	SERPENTIN
		38159	TENSOR PARA BANDA MICRO-V	A.A.
6 CIL. 4.2 L	2005	38006	POLEA	
		36101	POLEA	
		38178	TENSOR PARA BANDA MICRO-V	
V8, 5.3 L	2005	38001	POLEA	SERPENTIN
		38009	POLEA	SERPENTIN
		38158	TENSOR PARA BANDA MICRO-V	SERPENTIN
		38159	TENSOR PARA BANDA MICRO-V	A.A.
6 CIL. 4.2 L	2004	36101	POLEA	
		38006	POLEA	
		38178	TENSOR PARA BANDA MICRO-V	
V8, 5.3 L	2004	38009	POLEA	SERPENTIN
		38001	POLEA	SERPENTIN
		38159	TENSOR PARA BANDA MICRO-V	A.A.
		38158	TENSOR PARA BANDA MICRO-V	SERPENTIN
6 CIL. 4.2 L	2003	36101	POLEA	
		38006	POLEA	
		38178	TENSOR PARA BANDA MICRO-V	
V8, 5.3 L	2003	38009	POLEA	SERPENTIN
		38001	POLEA	SERPENTIN
		38158	TENSOR PARA BANDA MICRO-V	SERPENTIN
		38159	TENSOR PARA BANDA MICRO-V	A.A.
6 CIL. 4.2 L	2002	38006	POLEA	
		36101	POLEA	
		38178	TENSOR PARA BANDA MICRO-V	

**SAVANA**

V6, 4.3 L	2007	38001	POLEA	LISO
		38008	POLEA	CON CANALES
		38008	POLEA	
		38103	TENSOR PARA BANDA MICRO-V	
V8, 4.8 L	2007	38009	POLEA	SERPENTIN
		38001	POLEA	SERPENTIN
		38159	TENSOR PARA BANDA MICRO-V	A.A.
		38158	TENSOR PARA BANDA MICRO-V	SERPENTIN
V8, 5.3 L	2007	38009	POLEA	SERPENTIN
		38001	POLEA	SERPENTIN
		38158	TENSOR PARA BANDA MICRO-V	SERPENTIN
		38159	TENSOR PARA BANDA MICRO-V	A.A.
V8, 6.0 L	2007	38001	POLEA	SERPENTIN
		38009	POLEA	SERPENTIN
		38158	TENSOR PARA BANDA MICRO-V	SERPENTIN
		38159	TENSOR PARA BANDA MICRO-V	A.A.
V8, 6.6 L	2007	38008	POLEA	
		38172	TENSOR PARA BANDA MICRO-V	
V6, 4.3 L	2006	38008	POLEA	CON CANALES
		38001	POLEA	LISO
		38008	POLEA	
		38103	TENSOR PARA BANDA MICRO-V	
V8, 4.8 L	2006	38009	POLEA	SERPENTIN
		38001	POLEA	SERPENTIN
		38159	TENSOR PARA BANDA MICRO-V	A.A.
		38158	TENSOR PARA BANDA MICRO-V	SERPENTIN
V8, 5.3 L	2006	38009	POLEA	SERPENTIN
		38001	POLEA	SERPENTIN
		38158	TENSOR PARA BANDA MICRO-V	A.A.
		38159	TENSOR PARA BANDA MICRO-V	SERPENTIN
V8, 6.0 L	2006	38009	POLEA	SERPENTIN
		38001	POLEA	SERPENTIN
		38158	TENSOR PARA BANDA MICRO-V	A.A.
		38159	TENSOR PARA BANDA MICRO-V	SERPENTIN

**JIMMY**

V6, 4.3 L	2005	38008	POLEA	CANADA
		38001	POLEA	LISO CANADA

V8, 6.0 L	2006	38159	TENSOR PARA BANDA MICRO-V	A.A.		38008	POLEA	
V8, 6.6 L	2006	38008	POLEA			38008	POLEA	CON CANALES
		38172	TENSOR PARA BANDA MICRO-V			38103	TENSOR PARA BANDA MICRO-V	
V6, 4.3 L	2005	38001	POLEA	LISO	V8, 5.7 L	2001	38008	POLEA
		38008	POLEA				38008	POLEA
		38103	TENSOR PARA BANDA MICRO-V				38001	POLEA
V8, 4.8 L	2005	38009	POLEA	SERPENTIN			38103	TENSOR PARA BANDA MICRO-V
		38001	POLEA	SERPENTIN	V8, 6.5 L	2001	38020	POLEA
		38159	TENSOR PARA BANDA MICRO-V	A.A.			38006	POLEA
		38158	TENSOR PARA BANDA MICRO-V	SERPENTIN			38118	TENSOR PARA BANDA MICRO-V
V8, 5.3 L	2005	38009	POLEA	SERPENTIN	V8, 8.1 L	2001	38001	POLEA
		38001	POLEA	SERPENTIN			38008	POLEA
		38159	TENSOR PARA BANDA MICRO-V	A.A.			38006	POLEA
		38158	TENSOR PARA BANDA MICRO-V	SERPENTIN			38258	TENSOR PARA BANDA MICRO-V
V8, 6.0 L	2005	38009	POLEA	SERPENTIN	V6, 4.3 L	2000	38001	POLEA
		38001	POLEA	SERPENTIN			38008	POLEA
		38159	TENSOR PARA BANDA MICRO-V	A.A.			38008	POLEA
		38158	TENSOR PARA BANDA MICRO-V	SERPENTIN			38103	TENSOR PARA BANDA MICRO-V
V6, 4.3 L	2004	38008	POLEA	LISO	V8, 5.0 L	2000	38008	POLEA
		38001	POLEA				38008	POLEA
		38103	TENSOR PARA BANDA MICRO-V				38001	POLEA
V8, 4.8 L	2004	38009	POLEA	SERPENTIN	V8, 5.7 L	2000	38103	TENSOR PARA BANDA MICRO-V
		38001	POLEA	SERPENTIN			38001	POLEA
		38159	TENSOR PARA BANDA MICRO-V	A.A.			38008	POLEA
		38158	TENSOR PARA BANDA MICRO-V	SERPENTIN			38008	POLEA
V8, 5.3 L	2004	38009	POLEA	SERPENTIN	V8, 6.5 L	2000	38103	TENSOR PARA BANDA MICRO-V
		38001	POLEA	SERPENTIN			38020	POLEA
		38159	TENSOR PARA BANDA MICRO-V	A.A.			38006	POLEA
		38158	TENSOR PARA BANDA MICRO-V	SERPENTIN			38118	TENSOR PARA BANDA MICRO-V
V8, 6.0 L	2004	38001	POLEA	SERPENTIN	V8, 7.4 L	2000	38008	POLEA
		38009	POLEA	SERPENTIN			38001	POLEA
		38158	TENSOR PARA BANDA MICRO-V	SERPENTIN			38103	TENSOR PARA BANDA MICRO-V
		38159	TENSOR PARA BANDA MICRO-V	A.A.				
V6, 4.3 L	2003	38001	POLEA	LISO				
		38008	POLEA					
		38103	TENSOR PARA BANDA MICRO-V					
V8, 4.8 L	2003	38009	POLEA	SERPENTIN	V8, 5.3 L	2010	91030	HERRAMIENTA INST. STRECH FIT
		38001	POLEA	SERPENTIN			36299	POLEA
		38159	TENSOR PARA BANDA MICRO-V	A.A.			39083	TENSOR
		38158	TENSOR PARA BANDA MICRO-V	SERPENTIN	V8, 6.2 L	2010	38009	TENSOR
V8, 5.3 L	2003	38001	POLEA	SERPENTIN			91030	HERRAMIENTA INST. STRECH FIT
		38009	POLEA	SERPENTIN			36299	POLEA
		38158	TENSOR PARA BANDA MICRO-V	SERPENTIN			39083	TENSOR
		38159	TENSOR PARA BANDA MICRO-V	A.A.	V8, 5.3 L	2009	38009	TENSOR
V8, 6.0 L	2003	38009	POLEA	SERPENTIN			91030	HERRAMIENTA INST. STRECH FIT
		38001	POLEA	SERPENTIN			36299	POLEA
		38158	TENSOR PARA BANDA MICRO-V	SERPENTIN			39083	TENSOR
		38159	TENSOR PARA BANDA MICRO-V	A.A.	V8, 6.2 L	2009	38009	TENSOR
V6, 4.3 L	2002	38008	POLEA	CON CANALES			91030	HERRAMIENTA INST. STRECH FIT
		38008	POLEA	LISO			36299	POLEA
		38001	POLEA		V8, 6.2 L	2008	38009	TENSOR
		38103	TENSOR PARA BANDA MICRO-V				39083	TENSOR
V8, 5.0 L	2002	38008	POLEA	LISO			36169	POLEA
		38001	POLEA	CON CANALES			38009	TENSOR
		38008	POLEA				38158	TENSOR
		38103	TENSOR PARA BANDA MICRO-V		V8, 6.2 L	2007	38001	TENSOR
V8, 5.7 L	2002	38008	POLEA	CON CANALES			38159	TENSOR
		38001	POLEA	LISO			36169	POLEA
		38008	POLEA				38009	TENSOR
		38103	TENSOR PARA BANDA MICRO-V				38001	TENSOR
V8, 6.5 L	2002	38020	POLEA				38159	TENSOR
		38006	POLEA				38158	TENSOR
		38118	TENSOR PARA BANDA MICRO-V					
V8, 8.1 L	2002	38001	POLEA	LISO				
		38008	POLEA	CON CANALES	V6, 4.3 L	2004	38001	POLEA
		38006	POLEA				38008	POLEA
		38258	TENSOR PARA BANDA MICRO-V				38103	TENSOR PARA BANDA MICRO-V
V6, 4.3 L	2001	38008	POLEA	CON CANALES	4 CIL. 2.2 L	2003	38015	POLEA
		38008	POLEA	LISO			38165	TENSOR PARA BANDA MICRO-V
		38001	POLEA		V6, 4.3 L	2003	38001	POLEA
		38103	TENSOR PARA BANDA MICRO-V				38008	POLEA
V8, 5.0 L	2001	38001	POLEA	LISO			38103	TENSOR PARA BANDA MICRO-V
					4 CIL. 2.2 L	2002	38015	POLEA

**SIERRA**

V8, 5.3 L	2010	91030	HERRAMIENTA INST. STRECH FIT	
		36299	POLEA	
		39083	TENSOR	
		38009	TENSOR	
V8, 6.2 L	2010	91030	HERRAMIENTA INST. STRECH FIT	
		36299	POLEA	
		39083	TENSOR	
		38009	TENSOR	
V8, 5.3 L	2009	91030	HERRAMIENTA INST. STRECH FIT	
		36299	POLEA	
		39083	TENSOR	
		38009	TENSOR	
V8, 6.2 L	2009	91030	HERRAMIENTA INST. STRECH FIT	
		36299	POLEA	
		38009	TENSOR	
		39083	TENSOR	
V8, 6.2 L	2008	36169	POLEA	A/A
		38009	TENSOR	SERPENTIN
		38158	TENSOR	SERPENTIN
		38001	TENSOR	SERPENTIN
		38159	TENSOR	A/A
V8, 6.2 L	2007	36169	POLEA	A/A
		38009	TENSOR	SERPENTIN
		38001	TENSOR	SERPENTIN
		38159	TENSOR	A/A
		38158	TENSOR	SERPENTIN

**SONOMA**

V6, 4.3 L	2004	38001	POLEA	LISO
		38008	POLEA	
		38103	TENSOR PARA BANDA MICRO-V	
4 CIL. 2.2 L	2003	38015	POLEA	
		38165	TENSOR PARA BANDA MICRO-V	
V6, 4.3 L	2003	38001	POLEA	LISO
		38008	POLEA	
		38103	TENSOR PARA BANDA MICRO-V	
4 CIL. 2.2 L	2002	38015	POLEA	

4 CIL. 2.2 L	2002	38165	TENSOR PARA BANDA MICRO-V						
V6. 4.3 L	2002	38001	POLEA	LISO					
		38008	POLEA						
		38103	TENSOR PARA BANDA MICRO-V						HIDRAULICO
4 CIL. 2.2 L	2001	38015	POLEA						
		38165	TENSOR PARA BANDA MICRO-V		4 CIL. 2.4 L	2007			
V6. 4.3 L	2001	38001	POLEA	LISO	V6. 3.0 L	2007	TCKWP329	KIT DE DISTRIBUCION CON B.A.	
		38008	POLEA				36112	POLEA	
		38103	TENSOR PARA BANDA MICRO-V				38332	TENSOR	
4 CIL. 2.2 L	2000	38015	POLEA				T41232	TENSOR- POLEA DE DIST.	
		38165	TENSOR PARA BANDA MICRO-V				T41232	TENSOR- POLEA DE DIST.	
V6. 4.3 L	2000	38001	POLEA	LISO			T41231	TENSOR- POLEA DE DIST.	POLEA
		38008	POLEA				T43129	TENSOR- POLEA DE DIST.	HIDRAULICO
		38103	TENSOR PARA BANDA MICRO-V		V6. 3.0 L Electric Assist	2007	T41231	TENSOR- POLEA DE DIST.	POLEA
							T43129	TENSOR- POLEA DE DIST.	HIDRAULICO

**YUKON**

V8. 6.2 L	2010	91030	HERRAMIENTA INST. STRECH FIT		4 CIL. 2.4 L	2006	38278	TENSOR	
		36299	POLEA		V6. 3.0 L	2006	TCKWP329	KIT DE DISTRIBUCION CON B.A.	
		39083	TENSOR				36112	POLEA	
		38009	TENSOR				38332	TENSOR	
V8. 6.2 L	2009	91030	HERRAMIENTA INST. STRECH FIT				T43129	TENSOR- POLEA DE DIST.	HIDRAULICO
		36299	POLEA		V6. 3.0 L Electric Assist	2006	T41232	TENSOR- POLEA DE DIST.	
		39083	TENSOR				T41231	TENSOR- POLEA DE DIST.	POLEA
		38009	TENSOR				T41231	TENSOR- POLEA DE DIST.	POLEA
V8. 5.3 L	2008	36169	POLEA	A/A	4 CIL. 2.4 L	2005	38278	TENSOR	
		38009	TENSOR	SERPENTIN	V6. 3.0 L	2005	TCKWP329	KIT DE DISTRIBUCION CON B.A.	
		38001	TENSOR	SERPENTIN			36112	POLEA	
		38159	TENSOR	A/A			38332	TENSOR	
		38158	TENSOR	SERPENTIN			T41231	TENSOR- POLEA DE DIST.	POLEA
V8. 6.2 L	2008	36169	POLEA	A/A			T43129	TENSOR- POLEA DE DIST.	HIDRAULICO
		38001	TENSOR	SERPENTIN	V6. 3.0 L Electric Assist	2005	T41232	TENSOR- POLEA DE DIST.	
		38009	TENSOR	SERPENTIN			T43129	TENSOR- POLEA DE DIST.	HIDRAULICO
		38159	TENSOR	A/A			T41231	TENSOR- POLEA DE DIST.	POLEA
		38158	TENSOR	SERPENTIN	4 CIL. 2.4 L	2004	38278	TENSOR	
V8. 5.3 L	2007	36169	POLEA	A/A	V6. 3.0 L	2004	TCKWP329	KIT DE DISTRIBUCION CON B.A.	
		38001	TENSOR	SERPENTIN			36112	POLEA	
		38158	TENSOR	SERPENTIN			38332	TENSOR	
		38009	TENSOR	SERPENTIN			T41231	TENSOR- POLEA DE DIST.	POLEA
		38159	TENSOR	SERPENTIN	4 CIL. 2.4 L	2003	38278	TENSOR	
V8. 6.2 L	2007	36169	POLEA	A/A	V6. 3.0 L	2003	TCKWP329	KIT DE DISTRIBUCION CON B.A.	
		38001	TENSOR	SERPENTIN			36112	POLEA	
		38159	TENSOR	A/A			38332	TENSOR	
		38009	TENSOR	SERPENTIN			T43129	TENSOR- POLEA DE DIST.	HIDRAULICO
		38158	TENSOR	SERPENTIN			T41231	TENSOR- POLEA DE DIST.	POLEA
V8. 6.5 L Diesel	1995	38267	TENSOR PARA BANDA MICRO-V		4 CIL. 2.3 L	2002	TCK244	KIT DE DISTRIBUCION	
V8. 6.5 L Diesel	1994	38267	TENSOR PARA BANDA MICRO-V				TCKWP244	KIT DE DISTRIBUCION CON B.A.	

**HONDA**

**ACCORD**

V6. 3.5 L	2011	TCKWP329	KIT DE DISTRIBUCION CON B.A.				T41013	TENSOR- POLEA DE DIST.	
4 CIL. 2.4 L	2010	39073	TENSOR		V6. 3.0 L	2001	T41014	TENSOR- POLEA DE DIST.	
V6. 3.5 L	2010	TCK329	KIT DE DISTRIBUCION				TCK286	KIT DE DISTRIBUCION	
		TCKWP329	KIT DE DISTRIBUCION CON B.A.				38169	TENSOR	ALT. Y.A.A.
		39092	TENSOR				38001	TENSOR	
		T41232	TENSOR- POLEA DE DIST.				T42038	TENSOR- POLEA DE DIST.	
		T43129	TENSOR- POLEA DE DIST.				T41090	TENSOR- POLEA DE DIST.	
		T41231	TENSOR- POLEA DE DIST.				T42038	TENSOR- POLEA DE DIST.	POLEA TENSORA
4 CIL. 2.4 L	2009	39073	TENSOR		4 CIL. 2.3 L	2000	T41090	TENSOR- POLEA DE DIST.	
V6. 3.5 L	2009	TCK329	KIT DE DISTRIBUCION				TCK244	KIT DE DISTRIBUCION	
		TCKWP329	KIT DE DISTRIBUCION CON B.A.				TCKWP244	KIT DE DISTRIBUCION CON B.A.	
		39092	TENSOR				T41013	TENSOR- POLEA DE DIST.	
		T41231	TENSOR- POLEA DE DIST.		V6. 3.0 L	2000	T41014	TENSOR- POLEA DE DIST.	
		T43129	TENSOR- POLEA DE DIST.				TCK286	KIT DE DISTRIBUCION	
		T41232	TENSOR- POLEA DE DIST.				38001	TENSOR	
4 CIL. 2.4 L	2008	39073	TENSOR				38169	TENSOR	ALT. Y.A.A.
V6. 3.5 L	2008	TCK329	KIT DE DISTRIBUCION				T41090	TENSOR- POLEA DE DIST.	
		TCKWP329	KIT DE DISTRIBUCION CON B.A.				T42038	TENSOR- POLEA DE DIST.	POLEA TENSORA
		39092	TENSOR				T42038	TENSOR- POLEA DE DIST.	



V6, 3.0 L	2000	T41090	SENSOR- POLEA DE DIST.	
4 CIL. 2.3 L	1999	TCK244	KIT DE DISTRIBUCION	
		TCKWP244	KIT DE DISTRIBUCION CON B.A.	
		T41014	SENSOR- POLEA DE DIST.	
		T41013	SENSOR- POLEA DE DIST.	
V6, 3.0 L	1999	TCK286	KIT DE DISTRIBUCION	
		38001	SENSOR	ALT. Y.A.A.
		38169	SENSOR	
		T42038	SENSOR- POLEA DE DIST.	
		T41090	SENSOR- POLEA DE DIST.	POLEA TENSORA
		T42038	SENSOR- POLEA DE DIST.	
		T41090	SENSOR- POLEA DE DIST.	
4 CIL. 2.3 L	1998	TCK244	KIT DE DISTRIBUCION	
		TCKWP244	KIT DE DISTRIBUCION CON B.A.	
		T41014	SENSOR- POLEA DE DIST.	
		T41013	SENSOR- POLEA DE DIST.	
V6, 3.0 L	1998	TCK286	KIT DE DISTRIBUCION	
		38169	SENSOR	ALT. Y.A.A.
		38001	SENSOR	
		T42038	SENSOR- POLEA DE DIST.	
		T41090	SENSOR- POLEA DE DIST.	POLEA TENSORA
		T42038	SENSOR- POLEA DE DIST.	
		T41090	SENSOR- POLEA DE DIST.	
4 CIL. 2.2 L	1997	TCKWP186	KIT DE DISTRIBUCION CON B.A.	
V6, 2.7 L	1997	TCKWP263	KIT DE DISTRIBUCION CON B.A.	
		T41015	SENSOR- POLEA DE DIST.	
		T41015	SENSOR- POLEA DE DIST.	
4 CIL. 2.2 L	1996	TCKWP186	KIT DE DISTRIBUCION CON B.A.	
V6, 2.7 L	1996	TCKWP263	KIT DE DISTRIBUCION CON B.A.	
		T41015	SENSOR- POLEA DE DIST.	
4 CIL. 2.2 L	1995	TCKWP186	KIT DE DISTRIBUCION CON B.A.	
V6, 2.7 L	1995	TCKWP263	KIT DE DISTRIBUCION CON B.A.	
		T41015	SENSOR- POLEA DE DIST.	
4 CIL. 2.2 L	1994	TCKWP186	KIT DE DISTRIBUCION CON B.A.	
		T41014	SENSOR- POLEA DE DIST.	BALANCIN
		T41013	SENSOR- POLEA DE DIST.	
4 CIL. 2.2 L	1993	TCKWP186	KIT DE DISTRIBUCION CON B.A.	
		T41014	SENSOR- POLEA DE DIST.	BALANCIN
		T41013	SENSOR- POLEA DE DIST.	
4 CIL. 2.2 L	1992	TCKWP186	KIT DE DISTRIBUCION CON B.A.	
		T41013	SENSOR- POLEA DE DIST.	BALANCIN
		T41014	SENSOR- POLEA DE DIST.	
4 CIL. 2.2 L	1991	TCKWP186	KIT DE DISTRIBUCION CON B.A.	
4 CIL. 2.2 L	1990	TCKWP186	KIT DE DISTRIBUCION CON B.A.	
4 CIL. 2.0 L	1989	T41012	SENSOR- POLEA DE DIST.	
4 CIL. 2.0 L	1988	T41012	SENSOR- POLEA DE DIST.	
4 CIL. 2.0 L	1987	T41012	SENSOR- POLEA DE DIST.	
4 CIL. 2.0 L	1986	T41012	SENSOR- POLEA DE DIST.	
4 CIL. 1.6 L (Canada)	1985	T41012	SENSOR- POLEA DE DIST.	
4 CIL. 1.8 L	1985	T41012	SENSOR- POLEA DE DIST.	
4 CIL. 1.6 L (Canada)	1984	T41012	SENSOR- POLEA DE DIST.	
4 CIL. 1.8 L	1984	T41012	SENSOR- POLEA DE DIST.	

4 CIL. 1.6 L		TCKWP224	KIT DE DISTRIBUCION CON B.A.	
4 CIL. 1.6 L	1997	TCK224	KIT DE DISTRIBUCION	A.A.
		38030	SENSOR	
		T41023	SENSOR- POLEA DE DIST.	
4 CIL. 1.6 L	1997	TCKWP224	KIT DE DISTRIBUCION CON B.A.	
4 CIL. 1.6 L	1996	TCKWP224	KIT DE DISTRIBUCION CON B.A.	
4 CIL. 1.5 L	1995	T41011	SENSOR- POLEA DE DIST.	
4 CIL. 1.5 L	1995	TCKWP143	KIT DE DISTRIBUCION CON B.A.	
4 CIL. 1.6 L	1995	TCKWP224A	KIT DE DISTRIBUCION CON B.A.	
4 CIL. 1.5 L	1994	T41011	SENSOR- POLEA DE DIST.	
4 CIL. 1.5 L	1994	TCKWP143	KIT DE DISTRIBUCION CON B.A.	
4 CIL. 1.6 L	1994	TCKWP224A	KIT DE DISTRIBUCION CON B.A.	
4 CIL. 1.5 L	1993	T41011	SENSOR- POLEA DE DIST.	
4 CIL. 1.5 L	1993	TCKWP143	KIT DE DISTRIBUCION CON B.A.	
4 CIL. 1.6 L	1993	TCKWP224A	KIT DE DISTRIBUCION CON B.A.	
4 CIL. 1.5 L	1992	T41011	SENSOR- POLEA DE DIST.	
4 CIL. 1.6 L	1992	T41011	SENSOR- POLEA DE DIST.	
4 CIL. 1.5 L	1992	TCKWP143	KIT DE DISTRIBUCION CON B.A.	
4 CIL. 1.6 L	1992	TCKWP224A	KIT DE DISTRIBUCION CON B.A.	
4 CIL. 1.5 L	1991	TCKWP143	KIT DE DISTRIBUCION CON B.A.	
		TCKWP143	KIT DE DISTRIBUCION CON B.A.	
4 CIL. 1.5 L	1990	TCKWP143	KIT DE DISTRIBUCION CON B.A.	
4 CIL. 1.5 L	1989	TCKWP143	KIT DE DISTRIBUCION CON B.A.	
4 CIL. 1.5 L	1988	TCKWP143	KIT DE DISTRIBUCION CON B.A.	
4 CIL. 1.3 L	1987	T41017	SENSOR- POLEA DE DIST.	
4 CIL. 1.5 L	1987	T41017	SENSOR- POLEA DE DIST.	
4 CIL. 1.3 L	1986	T41017	SENSOR- POLEA DE DIST.	
4 CIL. 1.5 L	1986	T41017	SENSOR- POLEA DE DIST.	
4 CIL. 1.3 L	1985	T41017	SENSOR- POLEA DE DIST.	
4 CIL. 1.5 L	1985	T41017	SENSOR- POLEA DE DIST.	
4 CIL. 1.3 L	1984	T41017	SENSOR- POLEA DE DIST.	
4 CIL. 1.5 L	1984	T41017	SENSOR- POLEA DE DIST.	

**CIVIC DEL SOL**

4 CIL. 1.6 L	1995	TCKWP224A	KIT DE DISTRIBUCION CON B.A.
4 CIL. 1.6 L	1994	TCKWP224A	KIT DE DISTRIBUCION CON B.A.
4 CIL. 1.6 L	1993	TCKWP224A	KIT DE DISTRIBUCION CON B.A.
4 CIL. 1.6 L	1992	TCKWP224A	KIT DE DISTRIBUCION CON B.A.

**CIVIC HIBRIDO**

4 CIL. 1.3 L	2010	39070	SENSOR
4 CIL. 1.3 L	2009	39070	SENSOR
4 CIL. 1.3 L	2008	39070	SENSOR
4 CIL. 1.3 L	2007	39070	SENSOR
4 CIL. 1.3 L	2006	39070	SENSOR
4 CIL. 1.3 L	2005	39070	SENSOR

**CR-V**

4 CIL. 2.4 L	2009	38278	SENSOR
4 CIL. 2.4 L	2008	38278	SENSOR
4 CIL. 2.4 L	2007	38278	SENSOR
4 CIL. 2.4 L	2006	38278	SENSOR
4 CIL. 2.4 L	2005	38278	SENSOR
4 CIL. 2.4 L	2004	38278	SENSOR
4 CIL. 2.0 L	2001	TCK184	KIT DE DISTRIBUCION
		TCKWP184	KIT DE DISTRIBUCION CON B.A.
		38030	SENSOR
		T41016	SENSOR- POLEA DE DIST.
4 CIL. 2.0 L	2000	TCK184	KIT DE DISTRIBUCION
		TCKWP184	KIT DE DISTRIBUCION CON B.A.
		38030	SENSOR
		T41016	SENSOR- POLEA DE DIST.
4 CIL. 2.0 L	1999	TCK184	KIT DE DISTRIBUCION
		TCKWP184	KIT DE DISTRIBUCION CON B.A.
		38030	SENSOR
		T41016	SENSOR- POLEA DE DIST.
4 CIL. 2.0 L	1998	TCKWP184	KIT DE DISTRIBUCION CON B.A.
4 CIL. 2.0 L	1997	TCKWP184	KIT DE DISTRIBUCION CON B.A.

**CRX**

<b>CIVIC</b>			
4 CIL. 1.8 L	2010	39077	SENSOR
4 CIL. 1.8 L	2009	39077	SENSOR
4 CIL. 1.8 L	2008	39077	SENSOR
4 CIL. 1.6 L	2000	TCK227	KIT DE DISTRIBUCION
		TCK224	KIT DE DISTRIBUCION
		T41023	SENSOR- POLEA DE DIST.
		T41023	SENSOR- POLEA DE DIST.
		T41016	SENSOR- POLEA DE DIST.
4 CIL. 1.6 L	2000	TCKWP224	KIT DE DISTRIBUCION CON B.A.
4 CIL. 1.6 L	1999	TCK227	KIT DE DISTRIBUCION
		TCK224	KIT DE DISTRIBUCION
		38030	SENSOR
		T41016	SENSOR- POLEA DE DIST.
		T41023	SENSOR- POLEA DE DIST.
4 CIL. 1.6 L	1999	TCKWP224	KIT DE DISTRIBUCION CON B.A.
4 CIL. 1.6 L	1998	TCK224	KIT DE DISTRIBUCION
		38030	SENSOR
		T41023	SENSOR- POLEA DE DIST.

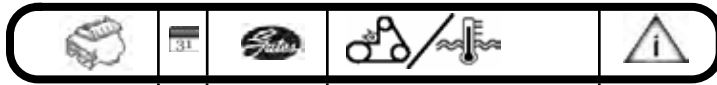

4 CIL. 1.5 L	1990	TCKWP143	KIT DE DISTRIBUCION CON B.A.
4 CIL. 1.5 L	1989	TCKWP143	KIT DE DISTRIBUCION CON B.A.
4 CIL. 1.5 L	1988	TCKWP143	KIT DE DISTRIBUCION CON B.A.



4 CIL. 2.2 L	1996	TCKWP186	KIT DE DISTRIBUCION CON B.A.
4 CIL. 2.2 L	1995	TCKWP186	KIT DE DISTRIBUCION CON B.A.
4 CIL. 2.2 L	1994	TCKWP186	KIT DE DISTRIBUCION CON B.A.
4 CIL. 2.2 L	1993	TCKWP186	KIT DE DISTRIBUCION CON B.A.
4 CIL. 2.2 L	1992	TCKWP186	KIT DE DISTRIBUCION CON B.A.
4 CIL. 2.2 L	1991	TCKWP186	KIT DE DISTRIBUCION CON B.A.
4 CIL. 2.2 L	1990	TCKWP186	KIT DE DISTRIBUCION CON B.A.

**ELEMENT**

4 CIL. 2.4 L	2005	38278	TENSOR PARA BANDA MICRO-V
4 CIL. 2.4 L	2004	38278	TENSOR PARA BANDA MICRO-V
4 CIL. 2.4 L	2003	38278	TENSOR PARA BANDA MICRO-V

**ODYSSEY**

V6. 3.5 L	2011	TCKWP329	KIT DE DISTRIBUCION CON B.A.	
V6. 3.5 L	2010	TCK329	KIT DE DISTRIBUCION	
		TCKWP329	KIT DE DISTRIBUCION CON B.A.	
		36112	POLEA	MOTOR J35A6
		36112	POLEA	MOTOR J35A6
		38332	TENSOR	MOTOR J35A6
		39092	TENSOR	MOTOR J35A7
		T43129	TENSOR- POLEA DE DIST.	
		T41231	TENSOR- POLEA DE DIST.	
		T41232	TENSOR- POLEA DE DIST.	
V6. 3.5 L	2009	TCK329	KIT DE DISTRIBUCION	
		TCKWP329	KIT DE DISTRIBUCION CON B.A.	
		36112	POLEA	MOTOR J35A6
		36112	POLEA	MOTOR J35A6
		38332	TENSOR	MOTOR J35A6
		39092	TENSOR	MOTOR J35A7
		T43129	TENSOR- POLEA DE DIST.	
		T41231	TENSOR- POLEA DE DIST.	
		T41232	TENSOR- POLEA DE DIST.	
V6. 3.5 L	2008	TCK329	KIT DE DISTRIBUCION	
		TCKWP329	KIT DE DISTRIBUCION CON B.A.	
		36112	POLEA	MOTOR J35A6
		36112	POLEA	MOTOR J35A6
		38332	TENSOR	MOTOR J35A6
		39092	TENSOR	MOTOR J35A7
		T41232	TENSOR- POLEA DE DIST.	
		T43129	TENSOR- POLEA DE DIST.	
		T41231	TENSOR- POLEA DE DIST.	
		T43129	TENSOR- POLEA DE DIST.	
		T41231	TENSOR- POLEA DE DIST.	
V6. 3.5 L	2007	TCKWP329	KIT DE DISTRIBUCION CON B.A.	
		36112	POLEA	
		38332	TENSOR	
		T43129	TENSOR- POLEA DE DIST.	HIDRAULICO
		T41231	TENSOR- POLEA DE DIST.	POLEA
		T41232	TENSOR- POLEA DE DIST.	
V6. 3.5 L	2006	TCKWP329	KIT DE DISTRIBUCION CON B.A.	
		36112	POLEA	
		38332	TENSOR	
		T43129	TENSOR- POLEA DE DIST.	HIDRAULICO
		T41232	TENSOR- POLEA DE DIST.	
		T41231	TENSOR- POLEA DE DIST.	POLEA
V6. 3.5 L	2005	TCKWP329	KIT DE DISTRIBUCION CON B.A.	
		36112	POLEA	
		38332	TENSOR	
		T43129	TENSOR- POLEA DE DIST.	HIDRAULICO
		T41231	TENSOR- POLEA DE DIST.	POLEA
V6. 3.5 L	2004	38322	TENSOR	
		38322	TENSOR PARA BANDA MICRO-V	
V6. 3.5 L	2003	38322	TENSOR	ALT. Y.A.A.
V6. 3.5 L	2002	38322	TENSOR	ALT. Y.A.A.
		38001	TENSOR	
		T41090	TENSOR- POLEA DE DIST.	
V6. 3.5 L	2001	38001	TENSOR	
		38327	TENSOR	ALT. Y.A.A.
V6. 3.5 L	2000	38001	TENSOR	
		38169	TENSOR	ALT. Y.A.A.
V6. 3.5 L	1999	38001	TENSOR	
		38169	TENSOR	ALT. Y.A.A.
4 CIL. 2.2 L	1997	TCKWP186	KIT DE DISTRIBUCION CON B.A.	
		TCKWP186	KIT DE DISTRIBUCION CON B.A.	

**PASSPORT**

V6. 3.2 L	2002	T42115	TENSOR- POLEA DE DIST.	POLEA TENSORA
		T41028	TENSOR- POLEA DE DIST.	
V6. 3.2 L	2001	T41028	TENSOR- POLEA DE DIST.	
		T42115	TENSOR- POLEA DE DIST.	POLEA TENSORA
V6. 3.2 L	2000	T42115	TENSOR- POLEA DE DIST.	POLEA TENSORA
		T41028	TENSOR- POLEA DE DIST.	
V6. 3.2 L	1999	T42115	TENSOR- POLEA DE DIST.	POLEA TENSORA
		T41028	TENSOR- POLEA DE DIST.	
V6. 3.2 L	1998	T42115	TENSOR- POLEA DE DIST.	POLEA TENSORA
		T41028	TENSOR- POLEA DE DIST.	
V6. 3.2 L	1997	TCKWP221	KIT DE DISTRIBUCION CON B.A.	
		36099	POLEA	A.A.
		T43095	TENSOR- POLEA DE DIST.	
		T42002	TENSOR- POLEA DE DIST.	POLEA TENSORA
		T41028	TENSOR- POLEA DE DIST.	
		T43095	TENSOR- POLEA DE DIST.	HIDRAULICO
		T42002	TENSOR- POLEA DE DIST.	
4 CIL. 2.6 L	1996	T41026	TENSOR- POLEA DE DIST.	
		T41026	TENSOR- POLEA DE DIST.	
V6. 3.2 L	1996	TCKWP221	KIT DE DISTRIBUCION CON B.A.	
		T43095	TENSOR- POLEA DE DIST.	HIDRAULICO
		T42002	TENSOR- POLEA DE DIST.	POLEA TENSORA
		T41028	TENSOR- POLEA DE DIST.	
4 CIL. 2.6 L	1995	T41026	TENSOR- POLEA DE DIST.	
		T41026	TENSOR- POLEA DE DIST.	
V6. 3.2 L	1995	TCKWP221	KIT DE DISTRIBUCION CON B.A.	
		T42002	TENSOR- POLEA DE DIST.	POLEA TENSORA
		T43094	TENSOR- POLEA DE DIST.	TENSOR HIDRAULICO
		T43094	TENSOR- POLEA DE DIST.	HIDRAULICO
		T41028	TENSOR- POLEA DE DIST.	
4 CIL. 2.6 L	1994	T41026	TENSOR- POLEA DE DIST.	
		T41026	TENSOR- POLEA DE DIST.	
V6. 3.2 L	1994	TCKWP221	KIT DE DISTRIBUCION CON B.A.	
		T41028	TENSOR- POLEA DE DIST.	POLEA TENSORA
		T42002	TENSOR- POLEA DE DIST.	HIDRAULICO
		T43094	TENSOR- POLEA DE DIST.	TENSOR HIDRAULICO

**PILOT**

V6. 3.5 L	2011	TCKWP329	KIT DE DISTRIBUCION CON B.A.	
V6. 3.5 L	2010	TCK329	KIT DE DISTRIBUCION	
		TCKWP329	KIT DE DISTRIBUCION CON B.A.	
		39092	TENSOR	
		T43129	TENSOR- POLEA DE DIST.	
		T41232	TENSOR- POLEA DE DIST.	
		T41231	TENSOR- POLEA DE DIST.	
V6. 3.5 L	2009	TCK329	KIT DE DISTRIBUCION	
		TCKWP329	KIT DE DISTRIBUCION CON B.A.	
		39092	TENSOR	
		T43129	TENSOR- POLEA DE DIST.	
		T41231	TENSOR- POLEA DE DIST.	
		T41232	TENSOR- POLEA DE DIST.	
V6. 3.5 L	2008	TCK329	KIT DE DISTRIBUCION	
		TCKWP329	KIT DE DISTRIBUCION CON B.A.	
		36112	POLEA	
		36112	POLEA	
		38332	TENSOR	
		T41232	TENSOR- POLEA DE DIST.	
		T43129	TENSOR- POLEA DE DIST.	
		T41231	TENSOR- POLEA DE DIST.	POLEA TENSORA
		T43129	TENSOR- POLEA DE DIST.	HIDRAULICO
		T41231	TENSOR- POLEA DE DIST.	

V6, 3.5 L	2007	TCKWP329	KIT DE DISTRIBUCION CON B.A.		
		36112	POLEA		
		38332	TENSOR		
		T41231	TENSOR- POLEA DE DIST.	POLEA	
		T43129	TENSOR- POLEA DE DIST.	HIDRAULICO	
		T41232	TENSOR- POLEA DE DIST.		
V6, 3.5 L	2006	TCKWP329	KIT DE DISTRIBUCION CON B.A.		
		36112	POLEA		
		38332	TENSOR		
		T43129	TENSOR- POLEA DE DIST.	HIDRAULICO	
		T41232	TENSOR- POLEA DE DIST.		
		T41231	TENSOR- POLEA DE DIST.	POLEA	
V6, 3.5 L	2005	TCKWP329	KIT DE DISTRIBUCION CON B.A.		
		36112	POLEA		
		38332	TENSOR		
		T43129	TENSOR- POLEA DE DIST.	HIDRAULICO	
		T41231	TENSOR- POLEA DE DIST.	POLEA	
V6, 3.5 L	2004	38327	TENSOR	ALT. Y.A.A.	
		T41090	TENSOR- POLEA DE DIST.		
V6, 3.5 L	2003	38327	TENSOR	ALT. Y.A.A.	
		T41090	TENSOR- POLEA DE DIST.		

4 CIL. 2.1 L		T41019	TENSOR- POLEA DE DIST.		
4 CIL. 2.2 L	1991	TCKWP186	KIT DE DISTRIBUCION CON B.A.		
4 CIL. 2.0 L	1990	T41019	TENSOR- POLEA DE DIST.		
		T41019	TENSOR- POLEA DE DIST.		
4 CIL. 2.1 L	1990	T41019	TENSOR- POLEA DE DIST.		
4 CIL. 2.2 L	1990	TCKWP186	KIT DE DISTRIBUCION CON B.A.		
4 CIL. 2.0 L	1989	T41019	TENSOR- POLEA DE DIST.		
		T41019	TENSOR- POLEA DE DIST.		
4 CIL. 2.0 L	1988	T41019	TENSOR- POLEA DE DIST.		
		T41019	TENSOR- POLEA DE DIST.		
4 CIL. 1.8 L	1987	T41012	TENSOR- POLEA DE DIST.		
4 CIL. 2.0 L	1987	T41012	TENSOR- POLEA DE DIST.		
4 CIL. 1.8 L	1986	T41012	TENSOR- POLEA DE DIST.		
4 CIL. 2.0 L	1986	T41012	TENSOR- POLEA DE DIST.		
4 CIL. 1.8 L	1985	T41012	TENSOR- POLEA DE DIST.		
4 CIL. 2.0 L	1985	T41012	TENSOR- POLEA DE DIST.		
4 CIL. 1.8 L	1984	T41012	TENSOR- POLEA DE DIST.		
4 CIL. 1.8 L	1983	T41012	TENSOR- POLEA DE DIST.		

**PRELUDE**

4 CIL. 2.2 L	2001	T41022	TENSOR- POLEA DE DIST.		
		T41024	TENSOR- POLEA DE DIST.		
4 CIL. 2.2 L	2000	T41022	TENSOR- POLEA DE DIST.	BALANCIN	
		T41024	TENSOR- POLEA DE DIST.		
4 CIL. 2.2 L	1999	T41022	TENSOR- POLEA DE DIST.	BALANCIN	
		T41024	TENSOR- POLEA DE DIST.		
4 CIL. 2.2 L	1998	T41024	TENSOR- POLEA DE DIST.		
		T41022	TENSOR- POLEA DE DIST.	BALANCIN	
4 CIL. 2.2 L	1997	T41022	TENSOR- POLEA DE DIST.	BALANCIN	
		T41024	TENSOR- POLEA DE DIST.		
4 CIL. 2.2 L	1996	TCKWP186	KIT DE DISTRIBUCION CON B.A.		
		T41014	TENSOR- POLEA DE DIST.		
		T41022	TENSOR- POLEA DE DIST.	BALANCIN	
		T41024	TENSOR- POLEA DE DIST.		
		T41013	TENSOR- POLEA DE DIST.	BALANCIN	
4 CIL. 2.3 L	1996	TCKWP216	KIT DE DISTRIBUCION CON B.A.		
		T41014	TENSOR- POLEA DE DIST.		
		T41013	TENSOR- POLEA DE DIST.	BALANCIN	
4 CIL. 2.2 L	1995	TCKWP186	KIT DE DISTRIBUCION CON B.A.		
		T41022	TENSOR- POLEA DE DIST.	BALANCIN	
		T41013	TENSOR- POLEA DE DIST.	BALANCIN	
		T41024	TENSOR- POLEA DE DIST.		
		T41014	TENSOR- POLEA DE DIST.		
4 CIL. 2.3 L	1995	TCKWP216	KIT DE DISTRIBUCION CON B.A.		
		T41013	TENSOR- POLEA DE DIST.	BALANCIN	
		T41014	TENSOR- POLEA DE DIST.		
4 CIL. 2.2 L	1994	TCKWP186	KIT DE DISTRIBUCION CON B.A.		
		T41013	TENSOR- POLEA DE DIST.	BALANCIN	
		T41024	TENSOR- POLEA DE DIST.		
		T41022	TENSOR- POLEA DE DIST.	BALANCIN	
		T41014	TENSOR- POLEA DE DIST.		
4 CIL. 2.3 L	1994	TCKWP216	KIT DE DISTRIBUCION CON B.A.		
		T41013	TENSOR- POLEA DE DIST.	BALANCIN	
		T41014	TENSOR- POLEA DE DIST.		
4 CIL. 2.2 L	1993	TCKWP186	KIT DE DISTRIBUCION CON B.A.		
		T41014	TENSOR- POLEA DE DIST.		
		T41013	TENSOR- POLEA DE DIST.	BALANCIN	
		T41024	TENSOR- POLEA DE DIST.		
		T41022	TENSOR- POLEA DE DIST.	BALANCIN	
4 CIL. 2.3 L	1993	TCKWP216	KIT DE DISTRIBUCION CON B.A.		
		T41014	TENSOR- POLEA DE DIST.		
		T41013	TENSOR- POLEA DE DIST.	BALANCIN	
4 CIL. 2.2 L	1992	TCKWP186	KIT DE DISTRIBUCION CON B.A.		
		T41014	TENSOR- POLEA DE DIST.		
		T41013	TENSOR- POLEA DE DIST.	BALANCIN	
4 CIL. 2.3 L	1992	TCKWP216	KIT DE DISTRIBUCION CON B.A.		
		T41013	TENSOR- POLEA DE DIST.	BALANCIN	
		T41014	TENSOR- POLEA DE DIST.		
4 CIL. 2.0 L	1991	T41019	TENSOR- POLEA DE DIST.		

**RIDGELINE**

V6, 3.5 L	2011	TCKWP329	KIT DE DISTRIBUCION CON B.A.		
V6, 3.5 L	2010	TCK329	KIT DE DISTRIBUCION		
		TCKWP329	KIT DE DISTRIBUCION CON B.A.		
		36112	POLEA		
		36112	POLEA		
		38332	TENSOR		
		T43129	TENSOR- POLEA DE DIST.		
		T41232	TENSOR- POLEA DE DIST.		
		T41231	TENSOR- POLEA DE DIST.		
V6, 3.5 L	2009	TCK329	KIT DE DISTRIBUCION		
		TCKWP329	KIT DE DISTRIBUCION CON B.A.		
		36112	POLEA		
		36112	POLEA		
		38332	TENSOR		
		T41231	TENSOR- POLEA DE DIST.		
		T41232	TENSOR- POLEA DE DIST.		
		T43129	TENSOR- POLEA DE DIST.		
V6, 3.5 L	2008	TCK329	KIT DE DISTRIBUCION		
		TCKWP329	KIT DE DISTRIBUCION CON B.A.		
		36112	POLEA		
		36112	POLEA		
		38332	TENSOR		
		T43129	TENSOR- POLEA DE DIST.		
		T41231	TENSOR- POLEA DE DIST.		
		T41231	TENSOR- POLEA DE DIST.		POLEA TENSORA
		T41232	TENSOR- POLEA DE DIST.		
V6, 3.5 L	2007	TCKWP329	KIT DE DISTRIBUCION CON B.A.		
		36112	POLEA		
		38332	TENSOR		
		T43129	TENSOR- POLEA DE DIST.		
		T41231	TENSOR- POLEA DE DIST.		
		T41232	TENSOR- POLEA DE DIST.		
V6, 3.5 L	2006	TCKWP329	KIT DE DISTRIBUCION CON B.A.		
		36112	POLEA		
		36112	POLEA		
		38332	TENSOR		
		T41231	TENSOR- POLEA DE DIST.		
		T41232	TENSOR- POLEA DE DIST.		
		T43129	TENSOR- POLEA DE DIST.		
V6, 3.5 L	2005	TCKWP329	KIT DE DISTRIBUCION CON B.A.		

**HUMMER**

**H1**

V8, 6.6 L	2007	38008	TENSOR		
		38172	TENSOR		
V8, 6.6 L	2006	38172	TENSOR		
		38008	TENSOR		

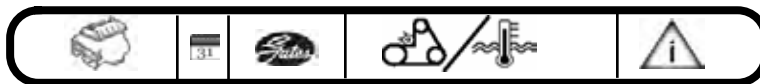
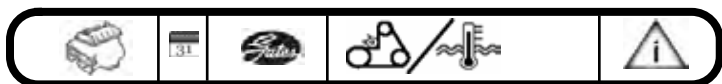

**H2**

V8, 6.2 L	2010	91030	HERRAMIENTA INST. STRECH FIT	
		36299	POLEA	
		38009	TENSOR	
		39083	TENSOR	
V8, 6.2 L	2009	91030	HERRAMIENTA INST. STRECH FIT	
		36299	POLEA	
		38009	TENSOR	
		39083	TENSOR	
V8, 6.2 L	2008	36169	POLEA	A.A.
		36299	POLEA	
		38159	TENSOR	A.A.
		38158	TENSOR	
		38009	TENSOR	
V8, 6.0 L	2007	38001	TENSOR	SERPENTIN
		38159	TENSOR	A.A.
		38158	TENSOR	SERPENTIN
		38009	TENSOR	SERPENTIN
V8, 6.0 L	2006	38001	TENSOR	
		38158	TENSOR	SERPENTIN
		38159	TENSOR	A.A.
V8, 6.0 L	2005	38001	TENSOR	
		38158	TENSOR	
		38159	TENSOR	

4 CIL. 1.1 L		TCK1013M	KIT DE DISTRIBUCION	
4 CIL. 1.1 L	2006	TCK1013M	KIT DE DISTRIBUCION	
		T41241	TENSOR- POLEA DE DIST.	
4 CIL. 1.1 L	2006	TCK1013M	KIT DE DISTRIBUCION	
4 CIL. 1.1 L	2005	TCK1013M	KIT DE DISTRIBUCION	
		T41241	TENSOR- POLEA DE DIST.	
4 CIL. 1.1 L	2005	TCK1013M	KIT DE DISTRIBUCION	
4 CIL. 1.0 L	2004	TCK1013M	KIT DE DISTRIBUCION	
		T41241	TENSOR- POLEA DE DIST.	
		T41241	TENSOR- POLEA DE DIST.	
4 CIL. 1.0 L	2004	TCK1013M	KIT DE DISTRIBUCION	
4 CIL. 1.0 L	2003	TCK1013M	KIT DE DISTRIBUCION	
		T41241	TENSOR- POLEA DE DIST.	
4 CIL. 1.0 L	2003	TCK1013M	KIT DE DISTRIBUCION	
4 CIL. 1.0 L	2002	TCK1013M	KIT DE DISTRIBUCION	
		T41241	TENSOR- POLEA DE DIST.	
4 CIL. 1.0 L	2002	TCK1013M	KIT DE DISTRIBUCION	
4 CIL. 1.0 L	2001	TCK1013M	KIT DE DISTRIBUCION	
		T41241	TENSOR- POLEA DE DIST.	
4 CIL. 1.0 L	2001	TCK1013M	KIT DE DISTRIBUCION	
4 CIL. 1.0 L	2000	TCK1013M	KIT DE DISTRIBUCION	
		T41241	TENSOR- POLEA DE DIST.	
4 CIL. 1.0 L	2000	TCK1013M	KIT DE DISTRIBUCION	

**H3**

5 CIL. 3.7 L	2010	36101	POLEA	
		36301	POLEA	
		38178	TENSOR	
5 CIL. 3.7 L	2009	36301	POLEA	
		36101	POLEA	
		38178	TENSOR	
5 CIL. 3.7 L	2008	36301	POLEA	
		36101	POLEA	
		38178	TENSOR	
5 CIL. 3.5 L	2007	36101	POLEA	
		38178	TENSOR	
5 CIL. 3.5 L	2006	36101	POLEA	
		38178	TENSOR	

**ATTITUDE**

4 CIL. 1.4 L	2010	36086	POLEA	
		T41037	TENSOR- POLEA DE DIST.	
		T42016	TENSOR- POLEA DE DIST.	
4 CIL. 1.6 L	2010	36086	POLEA	
		T42016	TENSOR- POLEA DE DIST.	
		T41037	TENSOR- POLEA DE DIST.	
4 CIL. 1.6 L	2010	TCK282M	KIT DE DISTRIBUCION	
4 CIL. 1.4 L	2009	36086	POLEA	
		T41037	TENSOR- POLEA DE DIST.	
		T42016	TENSOR- POLEA DE DIST.	
4 CIL. 1.6 L	2009	36086	POLEA	
		T42016	TENSOR- POLEA DE DIST.	
		T41037	TENSOR- POLEA DE DIST.	
4 CIL. 1.6 L	2009	TCK282M	KIT DE DISTRIBUCION	
4 CIL. 1.4 L	2008	36086	POLEA	
		T41037	TENSOR- POLEA DE DIST.	
		T42016	TENSOR- POLEA DE DIST.	
4 CIL. 1.6 L	2008	36086	POLEA	
		T42016	TENSOR- POLEA DE DIST.	
		T41037	TENSOR- POLEA DE DIST.	
4 CIL. 1.6 L	2008	TCK282M	KIT DE DISTRIBUCION	
4 CIL. 1.6 L	2007	36086	POLEA	A.A.
		T42016	TENSOR- POLEA DE DIST.	
		T41037	TENSOR- POLEA DE DIST.	
4 CIL. 1.6 L	2007	TCK282M	KIT DE DISTRIBUCION	
4 CIL. 1.6 L	2006	36086	POLEA	A.A.
		T42016	TENSOR- POLEA DE DIST.	
		T41037	TENSOR- POLEA DE DIST.	
4 CIL. 1.6 L	2006	TCK282M	KIT DE DISTRIBUCION	
4 CIL. 1.6 L	2005	TCK282M	KIT DE DISTRIBUCION	

**HYUNDAI**

**ACCENT**

4 CIL. 1.6 L	2006	T42016	TENSOR- POLEA DE DIST.	
4 CIL. 1.5 L	2003	36086	POLEA	A.A. CANADA
		T41037	TENSOR- POLEA DE DIST.	CANADA
4 CIL. 1.5 L	1999	T41051	TENSOR- POLEA DE DIST.	
4 CIL. 1.5 L	1998	T41051	TENSOR- POLEA DE DIST.	
4 CIL. 1.5 L	1997	T41051	TENSOR- POLEA DE DIST.	
4 CIL. 1.5 L	1996	T41051	TENSOR- POLEA DE DIST.	
4 CIL. 1.5 L	1995	T41051	TENSOR- POLEA DE DIST.	

**ATOS**

4 CIL. 1.1 L	2010	TCK1013M	KIT DE DISTRIBUCION	
		T41241	TENSOR- POLEA DE DIST.	
4 CIL. 1.1 L	2010	TCK1013M	KIT DE DISTRIBUCION	
4 CIL. 1.1 L	2009	TCK1013M	KIT DE DISTRIBUCION	
		T41241	TENSOR- POLEA DE DIST.	
4 CIL. 1.1 L	2009	TCK1013M	KIT DE DISTRIBUCION	
4 CIL. 1.1 L	2008	TCK1013M	KIT DE DISTRIBUCION	
		T41241	TENSOR- POLEA DE DIST.	
		T41241	TENSOR- POLEA DE DIST.	
4 CIL. 1.1 L	2008	TCK1013M	KIT DE DISTRIBUCION	
4 CIL. 1.1 L	2007	TCK1013M	KIT DE DISTRIBUCION	
		T41241	TENSOR- POLEA DE DIST.	

**ELANTRA**

4 CIL. 2.0 L	2006	T42015	TENSOR- POLEA DE DIST.	POLEA LOCA
		T41041	TENSOR- POLEA DE DIST.	
4 CIL. 2.0 L	2005	T42015	TENSOR- POLEA DE DIST.	POLEA LOCA
		T41041	TENSOR- POLEA DE DIST.	
4 CIL. 2.0 L	2004	T41041	TENSOR- POLEA DE DIST.	
		T42015	TENSOR- POLEA DE DIST.	POLEA LOCA
4 CIL. 2.0 L	2003	T41041	TENSOR- POLEA DE DIST.	
		T42015	TENSOR- POLEA DE DIST.	POLEA LOCA
4 CIL. 2.0 L	2002	T42015	TENSOR- POLEA DE DIST.	POLEA LOCA
		T41041	TENSOR- POLEA DE DIST.	
4 CIL. 2.0 L	2001	T42015	TENSOR- POLEA DE DIST.	POLEA LOCA
		T41041	TENSOR- POLEA DE DIST.	
4 CIL. 2.0 L	2000	T41041	TENSOR- POLEA DE DIST.	

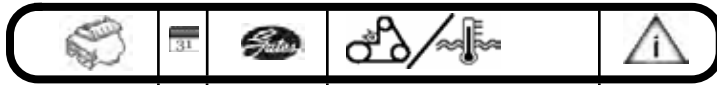

4 CIL. 2.0 L	2000	T42015	TENSOR- POLEA DE DIST.	POLEA LOCA
4 CIL. 2.0 L	1999	T41041	TENSOR- POLEA DE DIST.	POLEA LOCA
		T42015	TENSOR- POLEA DE DIST.	POLEA LOCA
4 CIL. 1.8 L	1998	T42015	TENSOR- POLEA DE DIST.	POLEA LOCA
		T41041	TENSOR- POLEA DE DIST.	POLEA LOCA
4 CIL. 1.8 L	1997	T42015	TENSOR- POLEA DE DIST.	POLEA LOCA
		T41041	TENSOR- POLEA DE DIST.	POLEA LOCA
4 CIL. 1.8 L	1996	T41041	TENSOR- POLEA DE DIST.	POLEA LOCA
		T42015	TENSOR- POLEA DE DIST.	POLEA LOCA
4 CIL. 1.6 L	1995	T41047	TENSOR- POLEA DE DIST.	BALANCIN
		T41046	TENSOR- POLEA DE DIST.	(DEL TENSOR)
4 CIL. 1.8 L	1995	T41046	TENSOR- POLEA DE DIST.	BALANCIN
		T41047	TENSOR- POLEA DE DIST.	(DEL TENSOR)
4 CIL. 1.6 L	1994	T41046	TENSOR- POLEA DE DIST.	BALANCIN
		T41047	TENSOR- POLEA DE DIST.	(DEL TENSOR)
4 CIL. 1.8 L	1994	T41046	TENSOR- POLEA DE DIST.	BALANCIN
		T41047	TENSOR- POLEA DE DIST.	(DEL TENSOR)
4 CIL. 1.6 L	1993	T41047	TENSOR- POLEA DE DIST.	BALANCIN
		T41046	TENSOR- POLEA DE DIST.	(DEL TENSOR)
4 CIL. 1.8 L	1993	T41047	TENSOR- POLEA DE DIST.	BALANCIN
		T41046	TENSOR- POLEA DE DIST.	(DEL TENSOR)
4 CIL. 1.6 L	1992	T41046	TENSOR- POLEA DE DIST.	(DEL TENSOR)
		T41047	TENSOR- POLEA DE DIST.	BALANCIN

**EXCEL**

4 CIL. 1.5 L	1994	T41042	TENSOR- POLEA DE DIST.	
4 CIL. 1.5 L	1993	T41042	TENSOR- POLEA DE DIST.	
4 CIL. 1.5 L	1992	T41042	TENSOR- POLEA DE DIST.	
4 CIL. 1.5 L	1991	T41042	TENSOR- POLEA DE DIST.	
4 CIL. 1.5 L	1990	T41042	TENSOR- POLEA DE DIST.	

**H100**

4 CIL. 2.5 L DIESEL	2010	T42129	TENSOR- POLEA DE DIST.	
4 CIL. 2.5 L DIESEL	2009	T42129	TENSOR- POLEA DE DIST.	
4 CIL. 2.4 L	2005	TCK124M	KIT DE DISTRIBUCION	
		T41044	TENSOR- POLEA DE DIST.	
		T41044	TENSOR- POLEA DE DIST.	
4 CIL. 2.4 L	2004	TCK124M	KIT DE DISTRIBUCION	
		T41044	TENSOR- POLEA DE DIST.	
4 CIL. 2.4 L	2003	TCK124M	KIT DE DISTRIBUCION	
		T41044	TENSOR- POLEA DE DIST.	

**H100 VAN/WAGON**

4 CIL. 2.5 L DIESEL	2010	T42129	TENSOR- POLEA DE DIST.	
4 CIL. 2.5 L DIESEL	2009	T42129	TENSOR- POLEA DE DIST.	

**SANTA FE**

V6, 2.7 L	2006	38149	TENSOR PARA BANDA MICRO-V	
		T42014	TENSOR- POLEA DE DIST.	POLEA LOCA
		T41040	TENSOR- POLEA DE DIST.	(DEL TENSOR)
4 CIL. 2.4 L (Canada)	2005	T41087	TENSOR- POLEA DE DIST.	(DEL TENSOR)
V6, 2.7 L	2005	38149	TENSOR PARA BANDA MICRO-V	
		T42014	TENSOR- POLEA DE DIST.	POLEA LOCA
		T41040	TENSOR- POLEA DE DIST.	(DEL TENSOR)
4 CIL. 2.4 L	2004	T41087	TENSOR- POLEA DE DIST.	(DEL TENSOR)
V6, 2.7 L	2004	38149	TENSOR PARA BANDA MICRO-V	
		T42014	TENSOR- POLEA DE DIST.	POLEA LOCA
		T41040	TENSOR- POLEA DE DIST.	(DEL TENSOR)
4 CIL. 2.4 L	2003	T41087	TENSOR- POLEA DE DIST.	(DEL TENSOR)
V6, 2.7 L	2003	38149	TENSOR PARA BANDA MICRO-V	
		T42014	TENSOR- POLEA DE DIST.	POLEA LOCA
		T41040	TENSOR- POLEA DE DIST.	(DEL TENSOR)
4 CIL. 2.4 L	2002	T41087	TENSOR- POLEA DE DIST.	(DEL TENSOR)
V6, 2.7 L	2002	38149	TENSOR PARA BANDA MICRO-V	
		T42014	TENSOR- POLEA DE DIST.	POLEA LOCA
		T41040	TENSOR- POLEA DE DIST.	(DEL TENSOR)
4 CIL. 2.4 L	2001	T41087	TENSOR- POLEA DE DIST.	(DEL TENSOR)
V6, 2.7 L	2001	38149	TENSOR PARA BANDA MICRO-V	
		T42014	TENSOR- POLEA DE DIST.	POLEA LOCA
		T41040	TENSOR- POLEA DE DIST.	(DEL TENSOR)



**SCOUPE**

4 CIL. 1.5 L	1995	T41051	TENSOR- POLEA DE DIST.	
4 CIL. 1.5 L	1994	T41051	TENSOR- POLEA DE DIST.	
4 CIL. 1.5 L	1993	T41042	TENSOR- POLEA DE DIST.	
4 CIL. 1.5 L	1992	T41042	TENSOR- POLEA DE DIST.	
4 CIL. 1.5 L	1991	T41042	TENSOR- POLEA DE DIST.	

**SONATA**

4 CIL. 2.4 L	2005	T41087	TENSOR- POLEA DE DIST.	(DEL TENSOR)
V6, 2.7 L	2005	38149	TENSOR PARA BANDA MICRO-V	
		T42014	TENSOR- POLEA DE DIST.	POLEA LOCA
		T41040	TENSOR- POLEA DE DIST.	(DEL TENSOR)
4 CIL. 2.4 L	2004	T41087	TENSOR- POLEA DE DIST.	(DEL TENSOR)
V6, 2.7 L	2004	38149	TENSOR PARA BANDA MICRO-V	
		T41040	TENSOR- POLEA DE DIST.	(DEL TENSOR)
		T42014	TENSOR- POLEA DE DIST.	POLEA LOCA
4 CIL. 2.4 L	2003	T41087	TENSOR- POLEA DE DIST.	(DEL TENSOR)
V6, 2.7 L	2003	38149	TENSOR PARA BANDA MICRO-V	
		T42014	TENSOR- POLEA DE DIST.	POLEA LOCA
		T41040	TENSOR- POLEA DE DIST.	(DEL TENSOR)
4 CIL. 2.4 L	2002	T41087	TENSOR- POLEA DE DIST.	(DEL TENSOR)
V6, 2.7 L	2002	38149	TENSOR PARA BANDA MICRO-V	
		T42014	TENSOR- POLEA DE DIST.	POLEA LOCA
		T41040	TENSOR- POLEA DE DIST.	(DEL TENSOR)
4 CIL. 2.4 L	2001	T41087	TENSOR- POLEA DE DIST.	(DEL TENSOR)
V6, 2.5 L	2001	38149	TENSOR PARA BANDA MICRO-V	
		T41040	TENSOR- POLEA DE DIST.	(DEL TENSOR)
		T42014	TENSOR- POLEA DE DIST.	POLEA LOCA
4 CIL. 2.4 L	2000	T41087	TENSOR- POLEA DE DIST.	(DEL TENSOR)
V6, 2.5 L	2000	38149	TENSOR PARA BANDA MICRO-V	
		T41040	TENSOR- POLEA DE DIST.	(DEL TENSOR)
		T42014	TENSOR- POLEA DE DIST.	POLEA LOCA
V6, 3.0 L	2000	TCKWP139	KIT DE DISTRIBUCION CON B.A.	
4 CIL. 2.4 L	1999	T41087	TENSOR- POLEA DE DIST.	(DEL TENSOR)
V6, 2.5 L	1999	38149	TENSOR PARA BANDA MICRO-V	
		T42014	TENSOR- POLEA DE DIST.	POLEA LOCA
		T41040	TENSOR- POLEA DE DIST.	(DEL TENSOR)
V6, 3.0 L	1999	TCKWP139	KIT DE DISTRIBUCION CON B.A.	
4 CIL. 2.0 L	1998	T41046	TENSOR- POLEA DE DIST.	BALANCIN
		T41047	TENSOR- POLEA DE DIST.	BALANCIN
V6, 3.0 L	1998	TCKWP139	KIT DE DISTRIBUCION CON B.A.	
4 CIL. 2.0 L	1997	T41047	TENSOR- POLEA DE DIST.	BALANCIN
		T41046	TENSOR- POLEA DE DIST.	BALANCIN
V6, 3.0 L	1997	TCKWP139	KIT DE DISTRIBUCION CON B.A.	
4 CIL. 2.0 L	1996	T41046	TENSOR- POLEA DE DIST.	BALANCIN
		T41047	TENSOR- POLEA DE DIST.	BALANCIN
V6, 3.0 L	1996	TCKWP139	KIT DE DISTRIBUCION CON B.A.	
4 CIL. 2.0 L	1995	T41046	TENSOR- POLEA DE DIST.	BALANCIN
		T41047	TENSOR- POLEA DE DIST.	BALANCIN
V6, 3.0 L	1995	TCKWP139	KIT DE DISTRIBUCION CON B.A.	
4 CIL. 2.0 L	1994	T41046	TENSOR- POLEA DE DIST.	BALANCIN
		T41047	TENSOR- POLEA DE DIST.	BALANCIN
V6, 3.0 L	1994	TCKWP139	KIT DE DISTRIBUCION CON B.A.	
4 CIL. 2.0 L	1993	T41046	TENSOR- POLEA DE DIST.	BALANCIN
		T41047	TENSOR- POLEA DE DIST.	BALANCIN
V6, 3.0 L	1993	TCKWP139	KIT DE DISTRIBUCION CON B.A.	
4 CIL. 2.0 L	1992	T41046	TENSOR- POLEA DE DIST.	BALANCIN
		T41047	TENSOR- POLEA DE DIST.	BALANCIN
V6, 3.0 L	1992	TCKWP139	KIT DE DISTRIBUCION CON B.A.	
4 CIL. 2.4 L	1991	T41053	TENSOR- POLEA DE DIST.	BALANCIN
V6, 3.0 L	1991	TCKWP139	KIT DE DISTRIBUCION CON B.A.	
4 CIL. 2.4 L	1990	T41053	TENSOR- POLEA DE DIST.	BALANCIN
V6, 3.0 L	1990	TCKWP139	KIT DE DISTRIBUCION CON B.A.	
4 CIL. 2.4 L	1989	T41053	TENSOR- POLEA DE DIST.	BALANCIN
V6, 3.0 L	1989	TCKWP139	KIT DE DISTRIBUCION CON B.A.	
V6, 3.0 L	1988	TCKWP139	KIT DE DISTRIBUCION CON B.A.	
V6, 3.0 L	1987	TCKWP139	KIT DE DISTRIBUCION CON B.A.	

**TIBURON**

4 CIL. 2.0 L	2006	T42015	TENSOR- POLEA DE DIST.	POLEA LOCA
V6. 2.7 L	2006	T41041	TENSOR- POLEA DE DIST.	
		38149	TENSOR PARA BANDA MICRO-V	
4 CIL. 2.0 L	2005	T42014	TENSOR- POLEA DE DIST.	POLEA LOCA
		T41040	TENSOR- POLEA DE DIST.	(DEL TENSOR)
		T41041	TENSOR- POLEA DE DIST.	POLEA LOCA
V6. 2.7 L	2005	38149	TENSOR PARA BANDA MICRO-V	
		T42014	TENSOR- POLEA DE DIST.	POLEA LOCA
		T41040	TENSOR- POLEA DE DIST.	(DEL TENSOR)
4 CIL. 2.0 L	2004	T42015	TENSOR- POLEA DE DIST.	POLEA LOCA
		T41041	TENSOR- POLEA DE DIST.	
V6. 2.7 L	2004	38149	TENSOR PARA BANDA MICRO-V	
		T41040	TENSOR- POLEA DE DIST.	(DEL TENSOR)
		T42014	TENSOR- POLEA DE DIST.	POLEA LOCA
4 CIL. 2.0 L	2003	T42015	TENSOR- POLEA DE DIST.	POLEA LOCA
		T41041	TENSOR- POLEA DE DIST.	
V6. 2.7 L	2003	38149	TENSOR PARA BANDA MICRO-V	
		T42014	TENSOR- POLEA DE DIST.	POLEA LOCA
		T41040	TENSOR- POLEA DE DIST.	(DEL TENSOR)
4 CIL. 2.0 L	2001	T41041	TENSOR- POLEA DE DIST.	POLEA LOCA
4 CIL. 2.0 L	2000	T42015	TENSOR- POLEA DE DIST.	POLEA LOCA
		T41041	TENSOR- POLEA DE DIST.	
4 CIL. 2.0 L	1999	T41041	TENSOR- POLEA DE DIST.	
		T42015	TENSOR- POLEA DE DIST.	POLEA LOCA
4 CIL. 1.8 L	1998	T42015	TENSOR- POLEA DE DIST.	POLEA LOCA
4 CIL. 2.0 L	1998	T41041	TENSOR- POLEA DE DIST.	POLEA LOCA
		T42015	TENSOR- POLEA DE DIST.	
4 CIL. 1.8 L	1997	T42015	TENSOR- POLEA DE DIST.	POLEA LOCA
		T41041	TENSOR- POLEA DE DIST.	
4 CIL. 2.0 L	1997	T42015	TENSOR- POLEA DE DIST.	POLEA LOCA
		T41041	TENSOR- POLEA DE DIST.	

**TUCSON**

4 CIL. 2.0 L	2006	T41041	TENSOR- POLEA DE DIST.	
V6. 2.7 L	2006	T42015	TENSOR- POLEA DE DIST.	POLEA LOCA
		38149	TENSOR PARA BANDA MICRO-V	
4 CIL. 2.0 L	2005	T41040	TENSOR- POLEA DE DIST.	(DEL TENSOR)
		T42014	TENSOR- POLEA DE DIST.	POLEA LOCA
		T41041	TENSOR- POLEA DE DIST.	
V6. 2.7 L	2005	T42015	TENSOR- POLEA DE DIST.	POLEA LOCA
		38149	TENSOR PARA BANDA MICRO-V	
4 CIL. 2.0 L	2004	T41040	TENSOR- POLEA DE DIST.	(DEL TENSOR)
		T42014	TENSOR- POLEA DE DIST.	POLEA LOCA

**VERNA**

4 CIL. 1.5 L	2006	TCK324M	KIT DE DISTRIBUCION	
4 CIL. 1.6 L	2006	T41037	TENSOR- POLEA DE DIST.	
		T41037	TENSOR- POLEA DE DIST.	POLEA LOCA
4 CIL. 1.5 L	2005	TCK324M	KIT DE DISTRIBUCION	
		T41037	TENSOR- POLEA DE DIST.	
4 CIL. 1.6 L	2005	T41037	TENSOR- POLEA DE DIST.	
4 CIL. 1.5 L	2004	TCK324M	KIT DE DISTRIBUCION	
		T41037	TENSOR- POLEA DE DIST.	

**ISUZU**

**AMIGO**

4 CIL. 2.2 L	2000	38154	TENSOR PARA BANDA MICRO-V	
V6. 3.2 L	2000	T42115	TENSOR- POLEA DE DIST.	POLEA TENSORA
		T41028	TENSOR- POLEA DE DIST.	
4 CIL. 2.2 L	1999	38154	TENSOR PARA BANDA MICRO-V	
		T42115	TENSOR- POLEA DE DIST.	POLEA TENSORA
V6. 3.2 L	1999	T41028	TENSOR- POLEA DE DIST.	
		38154	TENSOR PARA BANDA MICRO-V	
4 CIL. 2.2 L	1998	38154	TENSOR PARA BANDA MICRO-V	
V6. 3.2 L	1998	T41028	TENSOR- POLEA DE DIST.	

4 CIL. 2.6 L	1994	T42115	TENSOR- POLEA DE DIST.	POLEA TENSORA
4 CIL. 2.3 L	1993	T41026	TENSOR- POLEA DE DIST.	
		T41025	TENSOR- POLEA DE DIST.	
4 CIL. 2.6 L	1993	T41025	TENSOR- POLEA DE DIST.	
		T41026	TENSOR- POLEA DE DIST.	
4 CIL. 2.3 L	1992	T41025	TENSOR- POLEA DE DIST.	
		T41026	TENSOR- POLEA DE DIST.	
4 CIL. 2.6 L	1992	T41026	TENSOR- POLEA DE DIST.	
		T41025	TENSOR- POLEA DE DIST.	
4 CIL. 2.3 L	1991	T41025	TENSOR- POLEA DE DIST.	
		T41026	TENSOR- POLEA DE DIST.	
4 CIL. 2.6 L	1990	T41025	TENSOR- POLEA DE DIST.	
		T41026	TENSOR- POLEA DE DIST.	
4 CIL. 2.3 L	1989	T41025	TENSOR- POLEA DE DIST.	
		T41026	TENSOR- POLEA DE DIST.	
4 CIL. 2.6 L	1989	T41025	TENSOR- POLEA DE DIST.	
		T41026	TENSOR- POLEA DE DIST.	

**I-MARK**

4 CIL. 1.5 L (Canada)	1990	T41201	TENSOR- POLEA DE DIST.	
4 CIL. 1.6 L (Canada)	1990	T42001	TENSOR- POLEA DE DIST.	POLEA LOCA
		T41027	TENSOR- POLEA DE DIST.	
4 CIL. 1.5 L	1989	T41201	TENSOR- POLEA DE DIST.	
4 CIL. 1.6 L	1989	T42001	TENSOR- POLEA DE DIST.	POLEA LOCA
		T41027	TENSOR- POLEA DE DIST.	
4 CIL. 1.5 L	1988	T41201	TENSOR- POLEA DE DIST.	
4 CIL. 1.5 L	1987	T41201	TENSOR- POLEA DE DIST.	
4 CIL. 1.5 L	1986	T41201	TENSOR- POLEA DE DIST.	
4 CIL. 1.5 L	1985	T41201	TENSOR- POLEA DE DIST.	

**IMPULSE**

4 CIL. 1.6 L	1992	T42001	TENSOR- POLEA DE DIST.	POLEA LOCA
4 CIL. 1.8 L	1992	T41027	TENSOR- POLEA DE DIST.	
		T41027	TENSOR- POLEA DE DIST.	POLEA LOCA
4 CIL. 1.6 L	1991	T42001	TENSOR- POLEA DE DIST.	POLEA LOCA
		T41027	TENSOR- POLEA DE DIST.	
4 CIL. 1.6 L	1990	T41027	TENSOR- POLEA DE DIST.	
4 CIL. 2.0 L	1989	T41025	TENSOR- POLEA DE DIST.	POLEA LOCA
		T42001	TENSOR- POLEA DE DIST.	
4 CIL. 2.3 L	1989	T41025	TENSOR- POLEA DE DIST.	
4 CIL. 2.0 L	1988	T41025	TENSOR- POLEA DE DIST.	
4 CIL. 2.3 L	1988	T41025	TENSOR- POLEA DE DIST.	
4 CIL. 2.0 L	1987	T41025	TENSOR- POLEA DE DIST.	
4 CIL. 2.0 L	1986	T41025	TENSOR- POLEA DE DIST.	
4 CIL. 2.0 L	1985	T41025	TENSOR- POLEA DE DIST.	

**OASIS**

4 CIL. 2.2 L	1997	TCKWP186	KIT DE DISTRIBUCION CON B.A.	
4 CIL. 2.2 L	1996	TCKWP186	KIT DE DISTRIBUCION CON B.A.	

**PICKUP**

4 CIL. 2.3 L	1995	T41025	TENSOR- POLEA DE DIST.	
		T41025	TENSOR- POLEA DE DIST.	
4 CIL. 2.6 L	1995	T41026	TENSOR- POLEA DE DIST.	
		T41026	TENSOR- POLEA DE DIST.	
4 CIL. 2.3 L	1994	T41025	TENSOR- POLEA DE DIST.	
		T41025	TENSOR- POLEA DE DIST.	
4 CIL. 2.6 L	1994	T41026	TENSOR- POLEA DE DIST.	
		T41026	TENSOR- POLEA DE DIST.	
4 CIL. 2.3 L	1993	T41025	TENSOR- POLEA DE DIST.	
		T41025	TENSOR- POLEA DE DIST.	
4 CIL. 2.6 L	1993	T41026	TENSOR- POLEA DE DIST.	
		T41026	TENSOR- POLEA DE DIST.	
4 CIL. 2.3 L	1992	T41025	TENSOR- POLEA DE DIST.	
		T41025	TENSOR- POLEA DE DIST.	
4 CIL. 2.6 L	1992	T41026	TENSOR- POLEA DE DIST.	
		T41026	TENSOR- POLEA DE DIST.	
4 CIL. 2.3 L	1991	T41025	TENSOR- POLEA DE DIST.	
		T41025	TENSOR- POLEA DE DIST.	
4 CIL. 2.6 L	1991	T41026	TENSOR- POLEA DE DIST.	
		T41026	TENSOR- POLEA DE DIST.	

4 CIL. 2.3 L	1990	T41025	TENSOR- POLEA DE DIST.	
4 CIL. 2.6 L	1990	T41026	TENSOR- POLEA DE DIST.	
4 CIL. 2.3 L	1989	T41025	TENSOR- POLEA DE DIST.	
4 CIL. 2.6 L	1989	T41026	TENSOR- POLEA DE DIST.	
4 CIL. 2.3 L	1988	T41025	TENSOR- POLEA DE DIST.	
4 CIL. 2.6 L	1988	T41026	TENSOR- POLEA DE DIST.	
4 CIL. 2.3 L	1987	T41025	TENSOR- POLEA DE DIST.	
4 CIL. 2.3 L	1986	T41025	TENSOR- POLEA DE DIST.	

4 CIL. 1.8 L	1992	T41202	TENSOR- POLEA DE DIST.	
	1992	T41027	TENSOR- POLEA DE DIST.	
		T42001	TENSOR- POLEA DE DIST.	POLEA LOCA
4 CIL. 1.6 L	1991	T42001	TENSOR- POLEA DE DIST.	POLEA LOCA
		T41027	TENSOR- POLEA DE DIST.	
		T41202	TENSOR- POLEA DE DIST.	

**RODEO**

V6. 3.2 L	2004	T42115	TENSOR- POLEA DE DIST.	POLEA TENSORA
		T41028	TENSOR- POLEA DE DIST.	
V6. 3.5 L	2004	T41028	TENSOR- POLEA DE DIST.	
		T42115	TENSOR- POLEA DE DIST.	POLEA TENSORA
4 CIL. 2.2 L	2003	38154	TENSOR PARA BANDA MICRO-V	
V6. 3.2 L	2003	T42115	TENSOR- POLEA DE DIST.	POLEA TENSORA
		T41028	TENSOR- POLEA DE DIST.	
4 CIL. 2.2 L	2002	38154	TENSOR PARA BANDA MICRO-V	
V6. 3.2 L	2002	T41028	TENSOR- POLEA DE DIST.	POLEA TENSORA
		T42115	TENSOR- POLEA DE DIST.	
4 CIL. 2.2 L	2001	38154	TENSOR PARA BANDA MICRO-V	
V6. 3.2 L	2001	T42115	TENSOR- POLEA DE DIST.	POLEA TENSORA
		T41028	TENSOR- POLEA DE DIST.	
4 CIL. 2.2 L	2000	38154	TENSOR PARA BANDA MICRO-V	
V6. 3.2 L	2000	T42115	TENSOR- POLEA DE DIST.	POLEA TENSORA
		T41028	TENSOR- POLEA DE DIST.	
4 CIL. 2.2 L	1999	38154	TENSOR PARA BANDA MICRO-V	
V6. 3.2 L	1999	T41028	TENSOR- POLEA DE DIST.	POLEA TENSORA
		T42115	TENSOR- POLEA DE DIST.	
4 CIL. 2.2 L	1998	38154	TENSOR PARA BANDA MICRO-V	
V6. 3.2 L	1998	T41028	TENSOR- POLEA DE DIST.	POLEA TENSORA
		T42115	TENSOR- POLEA DE DIST.	
4 CIL. 2.6 L	1997	T41026	TENSOR- POLEA DE DIST.	POLEA TENSORA
		T41026	TENSOR- POLEA DE DIST.	
V6. 3.2 L	1997	TCKWP221	KIT DE DISTRIBUCION CON B.A.	
		T41028	TENSOR- POLEA DE DIST.	
		T42002	TENSOR- POLEA DE DIST.	POLEA TENSORA
		T43095	TENSOR- POLEA DE DIST.	HIDRAULICO
4 CIL. 2.6 L	1996	T41026	TENSOR- POLEA DE DIST.	
		T41026	TENSOR- POLEA DE DIST.	
V6. 3.2 L	1996	TCKWP221	KIT DE DISTRIBUCION CON B.A.	
		T43095	TENSOR- POLEA DE DIST.	HIDRAULICO
		T42002	TENSOR- POLEA DE DIST.	POLEA TENSORA
		T41028	TENSOR- POLEA DE DIST.	HIDRAULICO
4 CIL. 2.6 L	1995	T41026	TENSOR- POLEA DE DIST.	
		T41026	TENSOR- POLEA DE DIST.	
V6. 3.2 L	1995	TCKWP221	KIT DE DISTRIBUCION CON B.A.	
		T43094	TENSOR- POLEA DE DIST.	HIDRAULICO
		T43094	TENSOR- POLEA DE DIST.	TENSOR HIDRAULICO
4 CIL. 2.6 L	1994	T41026	TENSOR- POLEA DE DIST.	
		T41026	TENSOR- POLEA DE DIST.	
V6. 3.2 L	1994	TCKWP221	KIT DE DISTRIBUCION CON B.A.	
		T41028	TENSOR- POLEA DE DIST.	
		T42002	TENSOR- POLEA DE DIST.	POLEA TENSORA
		T43094	TENSOR- POLEA DE DIST.	TENSOR HIDRAULICO
		T43094	TENSOR- POLEA DE DIST.	HIDRAULICO
4 CIL. 2.6 L	1993	T41026	TENSOR- POLEA DE DIST.	
		T41026	TENSOR- POLEA DE DIST.	
V6. 3.2 L	1993	TCKWP221	KIT DE DISTRIBUCION CON B.A.	
		T41028	TENSOR- POLEA DE DIST.	
		T42002	TENSOR- POLEA DE DIST.	POLEA TENSORA
		T43094	TENSOR- POLEA DE DIST.	TENSOR HIDRAULICO
		T43094	TENSOR- POLEA DE DIST.	HIDRAULICO
4 CIL. 2.6 L	1992	T41026	TENSOR- POLEA DE DIST.	
		T41026	TENSOR- POLEA DE DIST.	
4 CIL. 2.6 L	1991	T41026	TENSOR- POLEA DE DIST.	

**TROOPER**

V6. 3.5 L	2002	T41028	TENSOR- POLEA DE DIST.	
		T42115	TENSOR- POLEA DE DIST.	POLEA TENSORA
V6. 3.5 L	2001	T41028	TENSOR- POLEA DE DIST.	
		T42115	TENSOR- POLEA DE DIST.	POLEA TENSORA
V6. 3.5 L	2000	T42115	TENSOR- POLEA DE DIST.	POLEA TENSORA
		T41028	TENSOR- POLEA DE DIST.	
V6. 3.5 L	1999	T41028	TENSOR- POLEA DE DIST.	
		T42115	TENSOR- POLEA DE DIST.	POLEA TENSORA
V6. 3.5 L	1998	T41028	TENSOR- POLEA DE DIST.	
		T42115	TENSOR- POLEA DE DIST.	POLEA TENSORA
V6. 3.2 L	1997	TCKWP221	KIT DE DISTRIBUCION CON B.A.	
		T41028	TENSOR- POLEA DE DIST.	
		T42002	TENSOR- POLEA DE DIST.	POLEA TENSORA
		T43095	TENSOR- POLEA DE DIST.	HIDRAULICO
V6. 3.2 L	1996	TCKWP221	KIT DE DISTRIBUCION CON B.A.	
		T41028	TENSOR- POLEA DE DIST.	
		T42002	TENSOR- POLEA DE DIST.	POLEA TENSORA
		T43095	TENSOR- POLEA DE DIST.	HIDRAULICO
V6. 3.2 L	1995	TCKWP221	KIT DE DISTRIBUCION CON B.A.	
		T41028	TENSOR- POLEA DE DIST.	
		T43094	TENSOR- POLEA DE DIST.	TENSOR HIDRAULICO
		T42002	TENSOR- POLEA DE DIST.	POLEA TENSORA
		T43094	TENSOR- POLEA DE DIST.	HIDRAULICO
V6. 3.2 L	1994	TCKWP221	KIT DE DISTRIBUCION CON B.A.	
		T42002	TENSOR- POLEA DE DIST.	POLEA TENSORA
		T43094	TENSOR- POLEA DE DIST.	TENSOR HIDRAULICO
		T43094	TENSOR- POLEA DE DIST.	HIDRAULICO
V6. 3.2 L	1993	TCKWP221	KIT DE DISTRIBUCION CON B.A.	
		T43094	TENSOR- POLEA DE DIST.	TENSOR HIDRAULICO
		T42002	TENSOR- POLEA DE DIST.	POLEA TENSORA
		T41028	TENSOR- POLEA DE DIST.	
		T43094	TENSOR- POLEA DE DIST.	HIDRAULICO
V6. 3.2 L	1992	TCKWP221	KIT DE DISTRIBUCION CON B.A.	
		T43094	TENSOR- POLEA DE DIST.	HIDRAULICO
		T41028	TENSOR- POLEA DE DIST.	
		T43094	TENSOR- POLEA DE DIST.	TENSOR HIDRAULICO
		T42002	TENSOR- POLEA DE DIST.	POLEA TENSORA
4 CIL. 2.6 L	1991	T41026	TENSOR- POLEA DE DIST.	
4 CIL. 2.6 L	1990	T41026	TENSOR- POLEA DE DIST.	

**TROOPER II**

4 CIL. 2.6 L	1989	T41026	TENSOR- POLEA DE DIST.	
4 CIL. 2.6 L	1988	T41026	TENSOR- POLEA DE DIST.	
4 CIL. 2.3 L	1987	T41025	TENSOR- POLEA DE DIST.	
4 CIL. 2.3 L	1986	T41025	TENSOR- POLEA DE DIST.	

**JAGUAR**

**S-TYPE**

V8. 4.0 L	2005	38001	POLEA LOCA	
		38001	TENSOR	
V8. 4.0 L	2004	38001	POLEA LOCA	
		38001	TENSOR	
V8. 4.0 L	2003	38001	POLEA LOCA	
		38001	TENSOR	
V8. 4.0 L	2002	38001	POLEA DEL TENSOR	
		38279	TENSOR	
		38001	TENSOR	
		38279	TENSOR PARA BANDA MICRO-V	

**STYLUS**

4 CIL. 1.6 L	1993	T41202	TENSOR- POLEA DE DIST.	
--------------	------	--------	------------------------	--

V8, 4.0 L	2001	38001	POLEA	
		38001	TENSOR	
		38279	TENSOR	
		38279	TENSOR PARA BANDA MICRO-V	
V8, 4.0 L	2000	38001	POLEA	
		38001	TENSOR	
		38279	TENSOR	
		38279	TENSOR PARA BANDA MICRO-V	

4 CIL. 2.5 L	1996	38042	TENSOR	
6 CIL. 4.0 L	1996	38019	TENSOR	CON CANALES
		38042	TENSOR	LISO
		38020	TENSOR	
4 CIL. 2.5 L	1995	38042	TENSOR	
6 CIL. 4.0 L	1995	38042	TENSOR	
		38020	TENSOR	

**X-TYPE**

V6, 2.5 L	2005	38279	TENSOR PARA BANDA MICRO-V
V6, 3.0 L	2005	38279	TENSOR PARA BANDA MICRO-V
V6, 2.5 L	2004	38279	TENSOR PARA BANDA MICRO-V
V6, 3.0 L	2004	38279	TENSOR PARA BANDA MICRO-V
V6, 2.5 L	2003	38279	TENSOR PARA BANDA MICRO-V
V6, 3.0 L	2003	38279	TENSOR PARA BANDA MICRO-V
V6, 2.5 L	2002	38279	TENSOR PARA BANDA MICRO-V
V6, 3.0 L	2002	38279	TENSOR PARA BANDA MICRO-V

**GRAND CHEROKEE**

V8, 5.7 L	2009	36313	POLEA
		38323	TENSOR
		38018	TENSOR
V8, 6.1 L	2009	36313	POLEA
		38323	TENSOR
V8, 5.7 L	2008	36313	POLEA
		38323	TENSOR
		38018	TENSOR
V8, 6.1 L	2008	36313	POLEA
		38323	TENSOR
V6, 3.7 L	2007	38167	TENSOR
		38009	TENSOR
		38001	TENSOR
V8, 4.7 L	2007	38001	TENSOR
		38167	TENSOR
		38009	TENSOR
V8, 5.7 L	2007	38323	TENSOR
		38018	TENSOR
V8, 6.1 L	2007	38018	TENSOR
		38323	TENSOR
V6, 3.7 L	2006	38167	TENSOR
		38009	TENSOR
		38001	TENSOR
V8, 4.7 L	2006	38167	TENSOR
		38001	TENSOR
		38009	TENSOR
V8, 5.7 L	2006	38323	TENSOR
		38018	TENSOR
V8, 6.1 L	2006	38018	TENSOR
		38323	TENSOR
V6, 3.7 L	2005	38009	TENSOR
		38167	TENSOR
		38001	TENSOR
V8, 4.7 L	2005	38009	TENSOR
		38167	TENSOR
		38001	TENSOR
V8, 5.7 L	2005	38018	TENSOR
		38323	TENSOR
6 CIL. 4.0 L	2004	38163	TENSOR PARA BANDA MICRO-V
V8, 4.7 L	2004	38009	TENSOR
		38167	TENSOR
		38001	TENSOR
V6, 4.0 L	2003	38018	TENSOR
		38043	TENSOR
V8, 4.7 L	2003	38009	TENSOR
		38167	TENSOR
		38042	TENSOR
		38001	TENSOR
6 CIL. 4.0 L	2002	38018	TENSOR
		38163	TENSOR
		38043	TENSOR
		38043	TENSOR
V8, 4.7 L	2002	38167	TENSOR
		38001	TENSOR
		38042	TENSOR
		38009	TENSOR
6 CIL. 4.0 L	2001	38043	TENSOR
		38163	TENSOR
		38018	TENSOR
		38043	TENSOR
V8, 4.7 L	2001	38167	TENSOR
		38001	TENSOR
		38009	TENSOR

**JEEP**

**COMMANDER**

V8, 5.7 L	2009	36313	POLEA
		38018	TENSOR
		38323	TENSOR
V8, 5.7 L	2008	38323	TENSOR
		38018	TENSOR
V8, 5.7 L	2007	38018	TENSOR
		38323	TENSOR
V8, 5.7 L	2006	38323	TENSOR
		38018	TENSOR

**COMPASS**

4 CIL. 2.4 L	2010	37018P	POLEA DECOPLADORA
		39053	TENSOR
4 CIL. 2.4 L	2009	37018P	POLEA DECOPLADORA
		39053	TENSOR
4 CIL. 2.4 L	2008	37018P	POLEA DECOPLADORA
		39053	TENSOR
4 CIL. 2.4 L	2007	37018P	POLEA DECOPLADORA
		39053	TENSOR

**CHEROKEE**

6 CIL. 4.0 L	2001	38042	TENSOR	AJUSTABLE
		38019	TENSOR	CON CANALES
6 CIL. 4.0 L	2000	38019	TENSOR	CON CANALES
		38020	TENSOR	
		38042	TENSOR	AJUSTABLE
6 CIL. 4.0 L	1999	38043	TENSOR	FIJO/ESTATICA
		38020	TENSOR	
		38019	TENSOR	CON CANALES
		38043	TENSOR	
		38042	TENSOR	AJUSTABLE
4 CIL. 2.5 L	1998	38043	TENSOR	FIJO/ESTATICA
6 CIL. 4.0 L	1998	38043	TENSOR	AJUSTABLE
		38019	TENSOR	CON CANALES
		38020	TENSOR	
		38042	TENSOR	AJUSTABLE
		38043	TENSOR	
4 CIL. 2.5 L	1997	38042	TENSOR	
		38043	TENSOR	
6 CIL. 4.0 L	1997	38019	TENSOR	CON CANALES
		38043	TENSOR	
		38042	TENSOR	
		38043	TENSOR	C/POLEA 76 mm
		38020	TENSOR	C/POLEA 90 mm



6 CIL. 4.0 L	2000	38018	SENSOR	
		38163	SENSOR	
		38043	SENSOR	
V8. 4.7 L	2000	38167	SENSOR	
		38009	SENSOR	
		38001	SENSOR	
6 CIL. 4.0 L	1999	38043	SENSOR	
		38043	SENSOR	
		38018	SENSOR	
		38020	SENSOR	
		38163	SENSOR	
V8. 4.7 L	1999	38001	SENSOR	
		38167	SENSOR	
		38009	SENSOR	
6 CIL. 4.0 L	1998	38042	SENSOR	AJUSTABLE
		38043	SENSOR	
		38020	SENSOR	
		38043	SENSOR	FIJO/ESTATICA
V8. 5.2 L	1998	38016	SENSOR	
		38033	SENSOR	
		38116	SENSOR	
V8. 5.9 L	1998	38116	SENSOR	
		38016	SENSOR	
		38033	SENSOR	
6 CIL. 4.0 L	1997	38042	SENSOR	AJUSTABLE
V8. 5.2 L	1997	38016	SENSOR	
		38033	SENSOR	
		38116	SENSOR	
6 CIL. 4.0 L	1996	38020	SENSOR	
		38042	SENSOR	
V8. 5.2 L	1996	38033	SENSOR	
		38016	SENSOR	
		38116	SENSOR	
6 CIL. 4.0 L	1995	38042	SENSOR	
V8. 5.2 L	1995	38033	SENSOR	
		38116	SENSOR	
		38016	SENSOR	
6 CIL. 4.0 L	1994	38042	SENSOR	
V8. 5.2 L	1994	38116	SENSOR	
V8. 5.2 L	1993	38116	SENSOR	

		38001	SENSOR	
		38042	SENSOR	
		38009	SENSOR	
V6. 3.7 L	2002	38042	SENSOR	
		38009	SENSOR	
		38001	SENSOR	
		38167	SENSOR	

**PATRIOT**

4 CIL. 2.4 L	2010	37018P	POLEA DECOPLADORA	
		39053	SENSOR	
4 CIL. 2.4 L	2009	37018P	POLEA DECOPLADORA	
		39053	SENSOR	
4 CIL. 2.4 L	2008	37018P	POLEA DECOPLADORA	
		39053	SENSOR	
4 CIL. 2.4 L	2007	37018P	POLEA DECOPLADORA	
		39053	SENSOR	

**TJ**

4 CIL. 2.4 L	2006	TCKWP265	KIT DE DISTRIBUCION CON B.A.	
		TCKWP265A	KIT DE DISTRIBUCION CON B.A.	
4 CIL. 2.4 L (Canada)	2006	T43131	SENSOR- POLEA DE DIST.	
4 CIL. 2.4 L	2005	TCKWP265	KIT DE DISTRIBUCION CON B.A.	
		TCKWP265A	KIT DE DISTRIBUCION CON B.A.	
4 CIL. 2.4 L (Canada)	2005	T43131	SENSOR- POLEA DE DIST.	
4 CIL. 2.4 L	2004	TCKWP265	KIT DE DISTRIBUCION CON B.A.	
		TCKWP265A	KIT DE DISTRIBUCION CON B.A.	
4 CIL. 2.4 L (Canada)	2004	T43131	SENSOR- POLEA DE DIST.	
4 CIL. 2.4 L	2003	TCKWP265A	KIT DE DISTRIBUCION CON B.A.	
		TCKWP265	KIT DE DISTRIBUCION CON B.A.	
4 CIL. 2.4 L (Canada)	2003	T43131	SENSOR- POLEA DE DIST.	

**WRANGLER**

V6. 3.8 L	2010	38018	SENSOR	
V6. 3.8 L	2009	38018	SENSOR	
V6. 3.8 L	2008	38018	SENSOR	
4 CIL. 2.4 L	2006	TCKWP265	KIT DE DISTRIBUCION CON B.A.	
		TCKWP265A	KIT DE DISTRIBUCION CON B.A.	
		38185	SENSOR	
		38018	SENSOR	
		38006	SENSOR	
		T43008	SENSOR- POLEA DE DIST.	
		T43131	SENSOR- POLEA DE DIST.	
		T42121	SENSOR- POLEA DE DIST.	
6 CIL. 4.0 L	2006	38163	SENSOR	
		38018	SENSOR	
		38043	SENSOR	
4 CIL. 2.4 L	2005	TCKWP265A	KIT DE DISTRIBUCION CON B.A.	
		TCKWP265	KIT DE DISTRIBUCION CON B.A.	
		38185	SENSOR	
		38006	SENSOR	
		38018	SENSOR	
		T42121	SENSOR- POLEA DE DIST.	
		T43008	SENSOR- POLEA DE DIST.	
		T43131	SENSOR- POLEA DE DIST.	
6 CIL. 4.0 L	2005	38163	SENSOR	
		38043	SENSOR	
		38018	SENSOR	
4 CIL. 2.4 L	2004	TCKWP265A	KIT DE DISTRIBUCION CON B.A.	
		TCKWP265	KIT DE DISTRIBUCION CON B.A.	
		38185	SENSOR	
		38006	SENSOR	
		38018	SENSOR	
		T43008	SENSOR- POLEA DE DIST.	
		T43131	SENSOR- POLEA DE DIST.	
		T42121	SENSOR- POLEA DE DIST.	
4 CIL. 2.4 L	2003	TCKWP265	KIT DE DISTRIBUCION CON B.A.	
		TCKWP265A	KIT DE DISTRIBUCION CON B.A.	
		38006	SENSOR	
		38018	SENSOR	

**LIBERTY**

V6. 3.7 L	2009	38009	SENSOR	RANURADA
		38015	SENSOR	LISA
V6. 3.7 L	2008	38009	SENSOR	RANURADA
		38015	SENSOR	LISA
V6. 3.7 L	2007	38009	SENSOR	
		38167	SENSOR	
		38042	SENSOR	
4 CIL. 2.4 L	2006	TCKWP265A	KIT DE DISTRIBUCION CON B.A.	
		TCKWP265	KIT DE DISTRIBUCION CON B.A.	
V6. 3.7 L	2006	38167	SENSOR	
		38001	SENSOR	
		38009	SENSOR	
		38042	SENSOR	
4 CIL. 2.4 L	2005	TCKWP265A	KIT DE DISTRIBUCION CON B.A.	
		TCKWP265	KIT DE DISTRIBUCION CON B.A.	
		T43131	SENSOR- POLEA DE DIST.	
V6. 3.7 L	2005	38042	SENSOR	LOCA
		38009	SENSOR	
		38167	SENSOR	
		38001	SENSOR	
4 CIL. 2.4 L	2004	TCKWP265	KIT DE DISTRIBUCION CON B.A.	
		TCKWP265A	KIT DE DISTRIBUCION CON B.A.	
		T43131	SENSOR- POLEA DE DIST.	
V6. 3.7 L	2004	38167	SENSOR	
		38009	SENSOR	
		38001	SENSOR	
4 CIL. 2.4 L	2003	TCKWP265	KIT DE DISTRIBUCION CON B.A.	
		TCKWP265A	KIT DE DISTRIBUCION CON B.A.	
		T43131	SENSOR- POLEA DE DIST.	
V6. 3.7 L	2003	38167	SENSOR	

4 CIL. 2.4 L	2003	38185 T43131 T43008 T42121	TENSOR TENSOR- POLEA DE DIST. TENSOR- POLEA DE DIST. TENSOR- POLEA DE DIST.	
6 CIL. 4.0 L	2003	38043 38018 38163	TENSOR TENSOR TENSOR	
4 CIL. 2.5 L	2002	38042 38043 38020 38043	TENSOR TENSOR TENSOR TENSOR	
6 CIL. 4.0 L	2002	38163 38043 38043 38043	TENSOR TENSOR TENSOR TENSOR	
4 CIL. 2.5 L	2001	38042 38043 38020 38043	TENSOR TENSOR TENSOR TENSOR	
6 CIL. 4.0 L	2001	38018 38043 38163	TENSOR TENSOR TENSOR	
4 CIL. 2.5 L	2000	38020 38043 38043 38042 38001	TENSOR TENSOR TENSOR TENSOR TENSOR	
6 CIL. 4.0 L	2000	38018 38043 38163	TENSOR TENSOR TENSOR	
4 CIL. 2.5 L	1999	38020 38042 38043 38001 38043	TENSOR TENSOR TENSOR TENSOR TENSOR	
6 CIL. 4.0 L	1999	38042 38043 38043	TENSOR TENSOR TENSOR	
4 CIL. 2.5 L	1998	38043 38043 38019 38042	TENSOR TENSOR TENSOR TENSOR	
6 CIL. 4.0 L	1998	38019 38043 38042	TENSOR TENSOR TENSOR	
4 CIL. 2.5 L	1997	38020 38042 38043 38043 38019	TENSOR TENSOR TENSOR TENSOR TENSOR	
6 CIL. 4.0 L	1997	38042 38043 38019	TENSOR TENSOR TENSOR	
4 CIL. 2.5 L	1995	38020 38042	TENSOR TENSOR	
4 CIL. 2.5 L	1994	38042	TENSOR	
4 CIL. 2.5 L	1993	38042	TENSOR	

4 CIL. 2.4 L (Canada)	2004	T41087	TENSOR- POLEA DE DIST.	
6. 2.7 L (Canada)	2004	38149 T42014 T41040	TENSOR PARA BANDA MICRO-V TENSOR- POLEA DE DIST. TENSOR- POLEA DE DIST.	POLEA LOCA (DEL TENSOR)
4 CIL. 2.4 L (Canada)	2003	T41087	TENSOR- POLEA DE DIST.	
6. 2.7 L (Canada)	2003	38149 T42014 T41040	TENSOR PARA BANDA MICRO-V TENSOR- POLEA DE DIST. TENSOR- POLEA DE DIST.	POLEA LOCA (DEL TENSOR)
4 CIL. 2.4 L (Canada)	2002	T41087	TENSOR- POLEA DE DIST.	
6. 2.7 L (Canada)	2002	38149 T41040 T42014	TENSOR PARA BANDA MICRO-V TENSOR- POLEA DE DIST. TENSOR- POLEA DE DIST.	(DEL TENSOR) POLEA LOCA
4 CIL. 2.4 L (Canada)	2001	T41087	TENSOR- POLEA DE DIST.	
6. 2.5 L (Canada)	2001	38149 T42014 T41040	TENSOR PARA BANDA MICRO-V TENSOR- POLEA DE DIST. TENSOR- POLEA DE DIST.	POLEA LOCA (DEL TENSOR)

**OPTIMA**

4 CIL. 2.4 L	2006	T41087	TENSOR- POLEA DE DIST.	
6. 2.7 L	2006	38149 T41040 T42014	TENSOR PARA BANDA MICRO-V TENSOR- POLEA DE DIST. TENSOR- POLEA DE DIST.	(DEL TENSOR) POLEA LOCA
4 CIL. 2.4 L	2005	T41087	TENSOR- POLEA DE DIST.	
6. 2.7 L	2005	38149 T42014 T41040	TENSOR PARA BANDA MICRO-V TENSOR- POLEA DE DIST. TENSOR- POLEA DE DIST.	POLEA LOCA (DEL TENSOR)
4 CIL. 2.4 L	2004	T41087	TENSOR- POLEA DE DIST.	
6. 2.7 L	2004	38149 T42014 T41040	TENSOR PARA BANDA MICRO-V TENSOR- POLEA DE DIST. TENSOR- POLEA DE DIST.	POLEA LOCA (DEL TENSOR)
4 CIL. 2.4 L	2003	T41087	TENSOR- POLEA DE DIST.	
6. 2.7 L	2003	38149 T41040 T42014	TENSOR PARA BANDA MICRO-V TENSOR- POLEA DE DIST. TENSOR- POLEA DE DIST.	(DEL TENSOR) POLEA LOCA
4 CIL. 2.4 L	2002	T41087	TENSOR- POLEA DE DIST.	
6. 2.7 L	2002	38149 T42014 T41040	TENSOR PARA BANDA MICRO-V TENSOR- POLEA DE DIST. TENSOR- POLEA DE DIST.	POLEA LOCA (DEL TENSOR)
4 CIL. 2.4 L	2001	T41087	TENSOR- POLEA DE DIST.	
6. 2.5 L	2001	38149 T41040 T42014	TENSOR PARA BANDA MICRO-V TENSOR- POLEA DE DIST. TENSOR- POLEA DE DIST.	(DEL TENSOR) POLEA LOCA

**SEPHIA**

4 CIL. 1.8 L	2001	T41032	TENSOR- POLEA DE DIST.	
4 CIL. 1.8 L	2000	T41032	TENSOR- POLEA DE DIST.	
4 CIL. 1.8 L	1999	T41032	TENSOR- POLEA DE DIST.	
4 CIL. 1.8 L	1998	T41032	TENSOR- POLEA DE DIST.	
4 CIL. 1.6 L	1995	T41030	TENSOR- POLEA DE DIST.	
4 CIL. 1.6 L	1994	T41030	TENSOR- POLEA DE DIST.	

**SPECTRA**

4 CIL. 2.0 L	2007	T42015 T41041	TENSOR- POLEA DE DIST. TENSOR- POLEA DE DIST.	POLEA LOCA
4 CIL. 2.0 L	2006	T42015 T41041	TENSOR- POLEA DE DIST. TENSOR- POLEA DE DIST.	POLEA LOCA
4 CIL. 2.0 L	2005	T42015 T41041	TENSOR- POLEA DE DIST. TENSOR- POLEA DE DIST.	POLEA LOCA
4 CIL. 1.8 L	2004	T41032	TENSOR- POLEA DE DIST.	
4 CIL. 2.0 L	2004	T42015 T41041	TENSOR- POLEA DE DIST. TENSOR- POLEA DE DIST.	POLEA LOCA
4 CIL. 1.8 L	2003	T41032	TENSOR- POLEA DE DIST.	
4 CIL. 1.8 L	2002	T41032	TENSOR- POLEA DE DIST.	
4 CIL. 1.8 L	2001	T41032	TENSOR- POLEA DE DIST.	
4 CIL. 1.8 L	2000	T41032	TENSOR- POLEA DE DIST.	

**SPORTAGE**

6. 2.7 L	2007	38149 T41040 T42014	TENSOR PARA BANDA MICRO-V TENSOR- POLEA DE DIST. TENSOR- POLEA DE DIST.	(DEL TENSOR) POLEA LOCA
----------	------	---------------------------	---	----------------------------

**KIA**

**MAGENTIS**

4 CIL. 2.4 L (Canada)	2006	T41087	TENSOR- POLEA DE DIST.	
6. 2.7 L (Canada)	2006	38149 T42014 T41040	TENSOR PARA BANDA MICRO-V TENSOR- POLEA DE DIST. TENSOR- POLEA DE DIST.	POLEA LOCA (DEL TENSOR)
4 CIL. 2.4 L (Canada)	2005	T41087	TENSOR- POLEA DE DIST.	
6. 2.7 L (Canada)	2005	38149 T41040 T42014	TENSOR PARA BANDA MICRO-V TENSOR- POLEA DE DIST. TENSOR- POLEA DE DIST.	(DEL TENSOR) POLEA LOCA

4 CIL. 2.0 L	2006	T42015	TENSOR- POLEA DE DIST.	POLEA LOCA
		T41041	TENSOR- POLEA DE DIST.	
V6, 2.7 L	2006	38149	TENSOR PARA BANDA MICRO-V	
		T42014	TENSOR- POLEA DE DIST.	POLEA LOCA
		T41040	TENSOR- POLEA DE DIST.	(DEL TENSOR)
4 CIL. 2.0 L	2005	T42015	TENSOR- POLEA DE DIST.	POLEA LOCA
		T41041	TENSOR- POLEA DE DIST.	
V6, 2.7 L	2005	38149	TENSOR PARA BANDA MICRO-V	
		T42014	TENSOR- POLEA DE DIST.	POLEA LOCA
		T41040	TENSOR- POLEA DE DIST.	(DEL TENSOR)
4 CIL. 2.0 L	2002	TCKWP281	KIT DE DISTRIBUCION CON B.A.	
		T42004	TENSOR- POLEA DE DIST.	POLEA LOCA
		T41029	TENSOR- POLEA DE DIST.	
4 CIL. 2.0 L	2001	TCKWP281	KIT DE DISTRIBUCION CON B.A.	
		T41029	TENSOR- POLEA DE DIST.	
		T42004	TENSOR- POLEA DE DIST.	POLEA LOCA
4 CIL. 2.0 L	2000	TCKWP281	KIT DE DISTRIBUCION CON B.A.	
		T41029	TENSOR- POLEA DE DIST.	
		T42004	TENSOR- POLEA DE DIST.	POLEA LOCA
4 CIL. 2.0 L	1999	TCKWP281	KIT DE DISTRIBUCION CON B.A.	
		T41029	TENSOR- POLEA DE DIST.	
		T42004	TENSOR- POLEA DE DIST.	POLEA LOCA
4 CIL. 2.0 L	1998	T42004	TENSOR- POLEA DE DIST.	POLEA LOCA
		T41029	TENSOR- POLEA DE DIST.	
4 CIL. 2.0 L	1997	TCKWP281	KIT DE DISTRIBUCION CON B.A.	
		T42004	TENSOR- POLEA DE DIST.	POLEA LOCA
		T41029	TENSOR- POLEA DE DIST.	
4 CIL. 2.0 L	1996	TCKWP281	KIT DE DISTRIBUCION CON B.A.	
		T42004	TENSOR- POLEA DE DIST.	POLEA LOCA
		T41029	TENSOR- POLEA DE DIST.	
4 CIL. 2.0 L	1995	TCKWP281	KIT DE DISTRIBUCION CON B.A.	
		T42003	TENSOR- POLEA DE DIST.	POLEA LOCA
		T41029	TENSOR- POLEA DE DIST.	
		T42004	TENSOR- POLEA DE DIST.	POLEA LOCA
		T41029	TENSOR- POLEA DE DIST.	



## LEXUS

### ES250

V6, 2.5 L	1991	TCKWP157	KIT DE DISTRIBUCION CON B.A.
V6, 2.5 L	1990	TCKWP157	KIT DE DISTRIBUCION CON B.A.

### ES300

V6, 3.0 L	1993	TCKWP200	KIT DE DISTRIBUCION CON B.A.
V6, 3.0 L	1992	TCKWP200	KIT DE DISTRIBUCION CON B.A.

### GS300

6 CIL. 3.0 L	2005	38170	TENSOR PARA BANDA MICRO-V	
		T43100	TENSOR- POLEA DE DIST.	TENSOR HIDRAULICO
6 CIL. 3.0 L	2004	38170	TENSOR PARA BANDA MICRO-V	
		T43100	TENSOR- POLEA DE DIST.	TENSOR HIDRAULICO
6 CIL. 3.0 L	2003	38170	TENSOR PARA BANDA MICRO-V	
		T43100	TENSOR- POLEA DE DIST.	TENSOR HIDRAULICO
6 CIL. 3.0 L	2002	38170	TENSOR PARA BANDA MICRO-V	
		T43100	TENSOR- POLEA DE DIST.	TENSOR HIDRAULICO
6 CIL. 3.0 L	2001	38170	TENSOR PARA BANDA MICRO-V	
		T43100	TENSOR- POLEA DE DIST.	TENSOR HIDRAULICO
6 CIL. 3.0 L	2000	38170	TENSOR PARA BANDA MICRO-V	
		T43100	TENSOR- POLEA DE DIST.	TENSOR HIDRAULICO
6 CIL. 3.0 L	1999	38170	TENSOR PARA BANDA MICRO-V	
		T43100	TENSOR- POLEA DE DIST.	TENSOR HIDRAULICO
6 CIL. 3.0 L	1998	38170	TENSOR PARA BANDA MICRO-V	
		T43100	TENSOR- POLEA DE DIST.	TENSOR HIDRAULICO
6 CIL. 3.0 L	1997	38170	TENSOR PARA BANDA MICRO-V	
		T43100	TENSOR- POLEA DE DIST.	TENSOR HIDRAULICO
6 CIL. 3.0 L	1996	38170	TENSOR PARA BANDA MICRO-V	
		T43100	TENSOR- POLEA DE DIST.	TENSOR HIDRAULICO
6 CIL. 3.0 L	1995	38170	TENSOR PARA BANDA MICRO-V	
		T43100	TENSOR- POLEA DE DIST.	TENSOR HIDRAULICO
6 CIL. 3.0 L	1994	38170	TENSOR PARA BANDA MICRO-V	
		T43100	TENSOR- POLEA DE DIST.	TENSOR HIDRAULICO
6 CIL. 3.0 L	1993	38170	TENSOR PARA BANDA MICRO-V	
		T43100	TENSOR- POLEA DE DIST.	TENSOR HIDRAULICO

### IS300

6 CIL. 3.0 L	2005	T43100	TENSOR- POLEA DE DIST.	TENSOR HIDRAULICO
6 CIL. 3.0 L	2004	T43100	TENSOR- POLEA DE DIST.	TENSOR HIDRAULICO
6 CIL. 3.0 L	2003	T43100	TENSOR- POLEA DE DIST.	TENSOR HIDRAULICO
6 CIL. 3.0 L	2002	38170	TENSOR PARA BANDA MICRO-V	
		T43100	TENSOR- POLEA DE DIST.	TENSOR HIDRAULICO
6 CIL. 3.0 L	2001	38170	TENSOR PARA BANDA MICRO-V	
		T43100	TENSOR- POLEA DE DIST.	TENSOR HIDRAULICO

### SC300

6 CIL. 3.0 L	2000	38170	TENSOR PARA BANDA MICRO-V	
		T43100	TENSOR- POLEA DE DIST.	TENSOR HIDRAULICO
6 CIL. 3.0 L	1999	38170	TENSOR PARA BANDA MICRO-V	
		T43100	TENSOR- POLEA DE DIST.	TENSOR HIDRAULICO
6 CIL. 3.0 L	1998	38170	TENSOR PARA BANDA MICRO-V	
		T43100	TENSOR- POLEA DE DIST.	TENSOR HIDRAULICO
6 CIL. 3.0 L	1997	38170	TENSOR PARA BANDA MICRO-V	
		T43100	TENSOR- POLEA DE DIST.	TENSOR HIDRAULICO
6 CIL. 3.0 L	1996	38170	TENSOR PARA BANDA MICRO-V	
		T43100	TENSOR- POLEA DE DIST.	TENSOR HIDRAULICO
6 CIL. 3.0 L	1995	38170	TENSOR PARA BANDA MICRO-V	
		T43100	TENSOR- POLEA DE DIST.	TENSOR HIDRAULICO
6 CIL. 3.0 L	1994	38170	TENSOR PARA BANDA MICRO-V	
		T43100	TENSOR- POLEA DE DIST.	TENSOR HIDRAULICO
6 CIL. 3.0 L	1993	38170	TENSOR PARA BANDA MICRO-V	
		T43100	TENSOR- POLEA DE DIST.	TENSOR HIDRAULICO
6 CIL. 3.0 L	1992	38170	TENSOR PARA BANDA MICRO-V	

## LAND ROVER

### DISCOVERY

V8, 4.0 L	2004	38102	TENSOR
V8, 4.0 L	2003	38102	TENSOR
V8, 4.0 L	2002	38102	TENSOR
		38245	TENSOR
		38245	TENSOR PARA BANDA MICRO-V
V8, 4.0 L	2001	38102	TENSOR
		38245	TENSOR
V8, 4.0 L	2000	38245	TENSOR
		38102	TENSOR
V8, 4.0 L	1999	38246	TENSOR
		38245	TENSOR

### DISCOVERY SERIES II

V8, 4.0 L	2001	38245	TENSOR
V8, 4.0 L	2000	38245	TENSOR
V8, 4.0 L	1999	38245	TENSOR

### RANGE ROVER

V8, 4.6 L	2002	38245	TENSOR
V8, 4.6 L	2001	38245	TENSOR
V8, 4.0 L	2000	38245	TENSOR
V8, 4.6 L	2000	38245	TENSOR
V8, 4.0 L	1999	38245	TENSOR
V8, 4.6 L	1999	38245	TENSOR
V8, 4.0 L	1998	38245	TENSOR
V8, 4.6 L	1998	38245	TENSOR

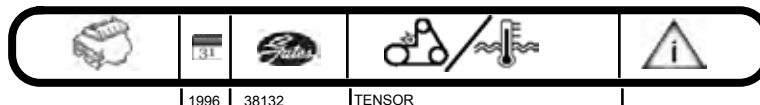
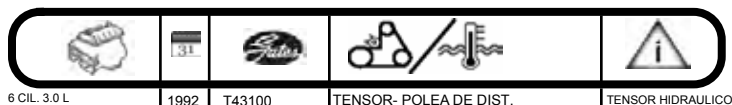

## LINCOLN

### AVIATOR

V8, 4.6 L	2005	36157 38274 38001 38006	POLEA TENSOR TENSOR TENSOR	
V8, 4.6 L	2004	36157 38001 38006 38274	POLEA TENSOR TENSOR TENSOR	
V8, 4.6 L	2003	36157 38001 38274 38006	POLEA TENSOR TENSOR TENSOR	

### MKX

V6, 3.5 L	2009	91030	HERRAMIENTA INST. STRECH FIT	
V6, 3.5 L	2008	91030	HERRAMIENTA INST. STRECH FIT	
V6, 3.5 L	2007	91030	HERRAMIENTA INST. STRECH FIT	

### MKZ

V6, 3.5 L	2009	91030	HERRAMIENTA INST. STRECH FIT	
V6, 3.5 L	2008	91030	HERRAMIENTA INST. STRECH FIT	
V6, 3.5 L	2007	91030	HERRAMIENTA INST. STRECH FIT	

### CONTINENTAL

V8, 4.6 L	2002	38251 38006 38251	TENSOR TENSOR TENSOR PARA BANDA MICRO-V	
V8, 4.6 L	2001	38251 38006	TENSOR TENSOR	
V8, 4.6 L	2000	38251 38006	TENSOR TENSOR	
V8, 4.6 L	1999	38006 38251	TENSOR TENSOR	
V8, 4.6 L	1998	38251 38006	TENSOR TENSOR	
V8, 4.6 L	1997	38006 38251	TENSOR TENSOR	
V8, 4.6 L	1996	38006	TENSOR	
V8, 4.6 L	1995	38006	TENSOR	

### NAVIGATOR

V8, 5.4 L	2009	36157 38274 38001 38006	POLEA TENSOR TENSOR TENSOR	RANURADA LISA A.A. RANURADA
V8, 5.4 L	2008	36157 38274 38001 38006	POLEA TENSOR TENSOR TENSOR	LISA A.A.
V8, 5.4 L	2007	38274	TENSOR	
V8, 5.4 L	2006	38274	TENSOR	
V8, 5.4 L	2005	38274	TENSOR	
V8, 5.4 L	2004	38001 38274	TENSOR TENSOR	
V8, 5.4 L	2003	38001 38006 38274	TENSOR TENSOR TENSOR	LISO
V8, 5.4 L	2002	38022 38133 38274 38023	TENSOR TENSOR TENSOR TENSOR	
V8, 5.4 L	2001	38022 38023 38133	TENSOR TENSOR TENSOR	
V8, 5.4 L	2000	38022 38133 38023 38133	TENSOR TENSOR TENSOR TENSOR	
V8, 5.4 L	1999	38022 38133 38023	TENSOR TENSOR TENSOR	
V8, 5.4 L	1998	38133 38022 38023	TENSOR TENSOR TENSOR	

### LS

V8, 3.9 L	2006	38279	TENSOR	
V8, 3.9 L	2005	38279	TENSOR	
V8, 3.9 L	2004	38279	TENSOR	
V8, 3.9 L	2003	38279	TENSOR	
V8, 3.9 L	2002	38001 38279	TENSOR TENSOR	
V6, 3.0 L	2001	38279 38001	TENSOR TENSOR	
V8, 3.9 L	2001	38279 38001	TENSOR TENSOR	
V6, 3.0 L	2000	38001 38279	TENSOR TENSOR	
V8, 3.9 L	2000	38001 38279	TENSOR TENSOR	

### TOWN CAR

V8, 4.6 L	2006	36100 38189 38006	POLEA TENSOR TENSOR	LISA CON CANALES
V8, 4.6 L	2004	36100 38189 38006	POLEA TENSOR TENSOR	
V8, 4.6 L	2003	38189 38006	TENSOR TENSOR	
V8, 4.6 L	2002	38189	TENSOR	
V8, 4.6 L	2001	36100 38189	POLEA TENSOR	CON CANALES
V8, 4.6 L	2000	38189 38006	TENSOR TENSOR	
V8, 4.6 L	1999	38132 38006	TENSOR TENSOR	
V8, 4.6 L	1998	38006 38132	TENSOR TENSOR	
V8, 4.6 L	1997	38006 38132	TENSOR TENSOR	

### MARK LT

V8, 5.4 L	2008	36157 38329 38006 38001 38274	POLEA TENSOR TENSOR TENSOR TENSOR	RANURADA SIN A.A. A.A. LISA CON A.A.
V8, 5.4 L	2007	36157 38274 38006 38329 38001	POLEA TENSOR TENSOR TENSOR TENSOR	RANURADA CON A.A. A.A. SIN A.A. LISA

### MARK VIII

V8, 4.6 L	1998	38132	TENSOR	
V8, 4.6 L	1997	38132	TENSOR	



V8, 4.6 L	1996	38132	SENSOR	
		38006	SENSOR	
V8, 4.6 L	1995	38132	SENSOR	
		38006	SENSOR	
V8, 4.6 L	1994	38006	SENSOR	
		38132	SENSOR	
V8, 4.6 L	1993	38006	SENSOR	
		38132	SENSOR	
V8, 4.6 L	1991	38288	SENSOR PARA BANDA MICRO-V	

4 CIL. 2.0 L	1993	T41034	TENSOR- POLEA DE DIST.	(DEL TENSOR)
		T42008	TENSOR- POLEA DE DIST.	POLEA LOCA
		T41091	TENSOR- POLEA DE DIST.	
V6, 2.5 L	1993	T41034	TENSOR- POLEA DE DIST.	(DEL TENSOR)
		T42009	TENSOR- POLEA DE DIST.	POLEA LOCA INF.
		T42010	TENSOR- POLEA DE DIST.	POLEA LOCA SUP.
4 CIL. 2.2 L	1992	T42003	TENSOR- POLEA DE DIST.	POLEA LOCA
		T41029	TENSOR- POLEA DE DIST.	
4 CIL. 2.2 L	1991	T41029	TENSOR- POLEA DE DIST.	
		T42003	TENSOR- POLEA DE DIST.	POLEA LOCA
4 CIL. 2.2 L	1990	T41029	TENSOR- POLEA DE DIST.	
		T42003	TENSOR- POLEA DE DIST.	POLEA LOCA
4 CIL. 2.2 L	1989	T42003	TENSOR- POLEA DE DIST.	POLEA LOCA
		T41029	TENSOR- POLEA DE DIST.	
4 CIL. 2.2 L	1988	T41029	TENSOR- POLEA DE DIST.	
		T42003	TENSOR- POLEA DE DIST.	POLEA LOCA
4 CIL. 2.0 L	1987	T41035	TENSOR- POLEA DE DIST.	
4 CIL. 2.0 L	1986	T41035	TENSOR- POLEA DE DIST.	

**MAZDA**

**323**

4 CIL. 1.6 L	1994	T41030	TENSOR- POLEA DE DIST.	
4 CIL. 1.6 L	1993	T41030	TENSOR- POLEA DE DIST.	
4 CIL. 1.6 L	1992	T41030	TENSOR- POLEA DE DIST.	
4 CIL. 1.6 L	1991	T41030	TENSOR- POLEA DE DIST.	
4 CIL. 1.8 L (Canada)	1991	T41030	TENSOR- POLEA DE DIST.	
4 CIL. 1.6 L	1990	T41030	TENSOR- POLEA DE DIST.	
4 CIL. 1.8 L (Canada)	1990	T41030	TENSOR- POLEA DE DIST.	
4 CIL. 1.6 L	1989	T41030	TENSOR- POLEA DE DIST.	
4 CIL. 1.6 L	1988	T41030	TENSOR- POLEA DE DIST.	
4 CIL. 1.6 L	1987	T41030	TENSOR- POLEA DE DIST.	

**626**

4 CIL. 2.0 L	2002	T41091	TENSOR- POLEA DE DIST.	
		T42008	TENSOR- POLEA DE DIST.	POLEA LOCA
V6, 2.5 L	2002	T42010	TENSOR- POLEA DE DIST.	POLEA LOCA SUP.
		T42009	TENSOR- POLEA DE DIST.	POLEA LOCA INF.
		T41034	TENSOR- POLEA DE DIST.	(DEL TENSOR)
4 CIL. 2.0 L	2001	T41091	TENSOR- POLEA DE DIST.	
		T42008	TENSOR- POLEA DE DIST.	POLEA LOCA
V6, 2.5 L	2001	T42010	TENSOR- POLEA DE DIST.	POLEA LOCA SUP.
		T42009	TENSOR- POLEA DE DIST.	POLEA LOCA INF.
		T41034	TENSOR- POLEA DE DIST.	(DEL TENSOR)
4 CIL. 2.0 L	2000	T42008	TENSOR- POLEA DE DIST.	POLEA LOCA
		T41091	TENSOR- POLEA DE DIST.	
V6, 2.5 L	2000	T41034	TENSOR- POLEA DE DIST.	(DEL TENSOR)
		T42010	TENSOR- POLEA DE DIST.	POLEA LOCA SUP.
		T42009	TENSOR- POLEA DE DIST.	POLEA LOCA INF.
4 CIL. 2.0 L	1999	T41091	TENSOR- POLEA DE DIST.	
		T42008	TENSOR- POLEA DE DIST.	POLEA LOCA
V6, 2.5 L	1999	T42009	TENSOR- POLEA DE DIST.	POLEA LOCA INF.
		T42010	TENSOR- POLEA DE DIST.	POLEA LOCA SUP.
		T41034	TENSOR- POLEA DE DIST.	(DEL TENSOR)
4 CIL. 2.0 L	1998	T42008	TENSOR- POLEA DE DIST.	POLEA LOCA
		T41091	TENSOR- POLEA DE DIST.	
V6, 2.5 L	1998	T42010	TENSOR- POLEA DE DIST.	POLEA LOCA SUP.
		T42009	TENSOR- POLEA DE DIST.	POLEA LOCA INF.
		T41034	TENSOR- POLEA DE DIST.	(DEL TENSOR)
4 CIL. 2.0 L	1997	T41091	TENSOR- POLEA DE DIST.	
		T42008	TENSOR- POLEA DE DIST.	POLEA LOCA
V6, 2.5 L	1997	T42010	TENSOR- POLEA DE DIST.	POLEA LOCA SUP.
		T42009	TENSOR- POLEA DE DIST.	POLEA LOCA INF.
		T41034	TENSOR- POLEA DE DIST.	(DEL TENSOR)
4 CIL. 2.0 L	1996	T41091	TENSOR- POLEA DE DIST.	
		T42008	TENSOR- POLEA DE DIST.	POLEA LOCA
V6, 2.5 L	1996	T42010	TENSOR- POLEA DE DIST.	POLEA LOCA SUP.
		T41034	TENSOR- POLEA DE DIST.	(DEL TENSOR)
		T42009	TENSOR- POLEA DE DIST.	POLEA LOCA INF.
4 CIL. 2.0 L	1995	T41091	TENSOR- POLEA DE DIST.	
		T42008	TENSOR- POLEA DE DIST.	POLEA LOCA
V6, 2.5 L	1995	T42010	TENSOR- POLEA DE DIST.	POLEA LOCA SUP.
		T42009	TENSOR- POLEA DE DIST.	POLEA LOCA INF.
		T41034	TENSOR- POLEA DE DIST.	(DEL TENSOR)
4 CIL. 2.0 L	1994	T42008	TENSOR- POLEA DE DIST.	POLEA LOCA
		T41091	TENSOR- POLEA DE DIST.	
V6, 2.5 L	1994	T42010	TENSOR- POLEA DE DIST.	POLEA LOCA SUP.
		T42009	TENSOR- POLEA DE DIST.	POLEA LOCA INF.

**929**

V6, 3.0 L	1995	T41036	TENSOR- POLEA DE DIST.	(DEL TENSOR)
		T42013	TENSOR- POLEA DE DIST.	POLEA LOCA SUP.
		T42012	TENSOR- POLEA DE DIST.	POLEA LOCA INF.
V6, 3.0 L	1994	T41036	TENSOR- POLEA DE DIST.	(DEL TENSOR)
		T42012	TENSOR- POLEA DE DIST.	POLEA LOCA INF.
		T42013	TENSOR- POLEA DE DIST.	POLEA LOCA SUP.
V6, 3.0 L	1993	T42012	TENSOR- POLEA DE DIST.	POLEA LOCA INF.
		T41036	TENSOR- POLEA DE DIST.	(DEL TENSOR)
V6, 3.0 L	1992	T42012	TENSOR- POLEA DE DIST.	POLEA LOCA INF.
		T41036	TENSOR- POLEA DE DIST.	(DEL TENSOR)
V6, 3.0 L	1991	T42001	TENSOR- POLEA DE DIST.	POLEA LOCA SUP.
		T41036	TENSOR- POLEA DE DIST.	POLEA LOCA INF.
		T41033	TENSOR- POLEA DE DIST.	
V6, 3.0 L	1990	T42011	TENSOR- POLEA DE DIST.	POLEA LOCA SUP.
		T42007	TENSOR- POLEA DE DIST.	POLEA LOCA SUP.
		T42006	TENSOR- POLEA DE DIST.	POLEA LOCA INF.
V6, 3.0 L	1990	T42001	TENSOR- POLEA DE DIST.	POLEA LOCA INF.
		T42007	TENSOR- POLEA DE DIST.	POLEA LOCA SUP.
		T42006	TENSOR- POLEA DE DIST.	POLEA LOCA INF.
		T42011	TENSOR- POLEA DE DIST.	POLEA LOCA SUP.
V6, 3.0 L	1989	T41033	TENSOR- POLEA DE DIST.	
		T42001	TENSOR- POLEA DE DIST.	POLEA LOCA INF.
		T42011	TENSOR- POLEA DE DIST.	POLEA LOCA SUP.
V6, 3.0 L	1988	T42001	TENSOR- POLEA DE DIST.	POLEA LOCA INF.
		T41033	TENSOR- POLEA DE DIST.	
		T42011	TENSOR- POLEA DE DIST.	POLEA LOCA SUP.

**B2000 PICKUP**

4 CIL. 2.0 L	1987	T41035	TENSOR- POLEA DE DIST.	
--------------	------	--------	------------------------	--

**B2200 PICKUP**

4 CIL. 2.2 L	1993	T41029	TENSOR- POLEA DE DIST.	
		T41029	TENSOR- POLEA DE DIST.	
		T42003	TENSOR- POLEA DE DIST.	POLEA LOCA
4 CIL. 2.2 L	1992	T42003	TENSOR- POLEA DE DIST.	POLEA TENSORA
		T42003	TENSOR- POLEA DE DIST.	POLEA LOCA
		T41029	TENSOR- POLEA DE DIST.	POLEA TENSORA
4 CIL. 2.2 L	1991	T41029	TENSOR- POLEA DE DIST.	
		T42003	TENSOR- POLEA DE DIST.	POLEA LOCA
4 CIL. 2.2 L	1990	T41029	TENSOR- POLEA DE DIST.	
		T42003	TENSOR- POLEA DE DIST.	POLEA LOCA
4 CIL. 2.2 L	1989	T41029	TENSOR- POLEA DE DIST.	
		T42003	TENSOR- POLEA DE DIST.	POLEA LOCA
4 CIL. 2.2 L	1988	T42003	TENSOR- POLEA DE DIST.	POLEA LOCA

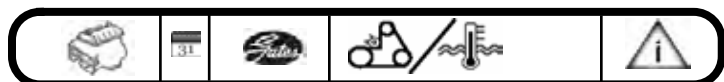

4 CIL. 2.2 L	1988	T41029	TENSOR- POLEA DE DIST.	
4 CIL. 2.2 L	1987	T42003	TENSOR- POLEA DE DIST.	POLEA LOCA
		T41029	TENSOR- POLEA DE DIST.	

**CX-7**

4 CIL. 2.3 L	2008	36263	POLEA	
		T39074	TENSOR- POLEA DE DIST.	
4 CIL. 2.3 L	2007	36263	POLEA	
		T39074	TENSOR- POLEA DE DIST.	
4 CIL. 2.3 L	2006	36263	POLEA	
		T39074	TENSOR- POLEA DE DIST.	

**CX-9**

V6. 3.7 L	2008	91030	HERRAMIENTA INST. STRECH FIT	
V6. 3.7 L	2007	91030	HERRAMIENTA INST. STRECH FIT	

**MAZDA 3**

4 CIL. 2.3 L	2010	38409	TENSOR	
		38006	TENSOR	
4 CIL. 2.3 L	2009	91030	HERRAMIENTA INST. STRECH FIT	
4 CIL. 2.0 L	2008	91030	HERRAMIENTA INST. STRECH FIT	
		38357	TENSOR	
		38357	TENSOR PARA BANDA MICRO-V	
4 CIL. 2.3 L	2008	91030	HERRAMIENTA INST. STRECH FIT	
		38357	TENSOR	CON T.A.; SIN TURBO
		38408	TENSOR	CON TURBO
4 CIL. 2.0 L	2007	91030	HERRAMIENTA INST. STRECH FIT	
		38357	TENSOR	
4 CIL. 2.3 L	2007	91030	HERRAMIENTA INST. STRECH FIT	
		38357	TENSOR	CON T.A.; SIN TURBO
		38408	TENSOR	CON TURBO
4 CIL. 2.0 L	2006	91030	HERRAMIENTA INST. STRECH FIT	
		38357	TENSOR	
4 CIL. 2.3 L	2006	91030	HERRAMIENTA INST. STRECH FIT	
		38357	TENSOR	CON T.A.; SIN TURBO
		38408	TENSOR	C/TURBO
		38408	TENSOR	CON TURBO

**MAZDA 5**

4 CIL. 2.3 L	2007	38357	TENSOR	CON TRANSMISION MANUAL
		38357	TENSOR	CON T.A.
4 CIL. 2.3 L	2006	38357	TENSOR	CON T.A.
		38357	TENSOR	CON TRANSMISION MANUAL

**MAZDA 6**

4 CIL. 2.3 L	2008	38006	TENSOR	
		38409	TENSOR	
V6. 3.0 L	2008	91030	HERRAMIENTA INST. STRECH FIT	
4 CIL. 2.3 L	2007	38408	TENSOR	CON TURBO
		38008	TENSOR	C/TURBO
		38409	TENSOR	SIN TURBO
		38409	TENSOR PARA BANDA MICRO-V	SIN TURBO
4 CIL. 2.3 L	2006	38409	TENSOR	SIN TURBO
		38008	TENSOR	C/TURBO
		38408	TENSOR	CON TURBO
V6. 3.0 L	2005	38308	TENSOR PARA BANDA MICRO-V	ACCESORIO

**MILLENNIA**

V6. 2.3 L	2002	T42010	TENSOR- POLEA DE DIST.	POLEA LOCA SUP.
		T42117	TENSOR- POLEA DE DIST.	POLEA LOCA INF.
		T41210	TENSOR- POLEA DE DIST.	(DEL TENSOR)
V6. 2.5 L	2002	T41034	TENSOR- POLEA DE DIST.	(DEL TENSOR)
		T42010	TENSOR- POLEA DE DIST.	POLEA LOCA SUP.
		T42009	TENSOR- POLEA DE DIST.	POLEA LOCA INF.
V6. 2.3 L	2001	T42010	TENSOR- POLEA DE DIST.	POLEA LOCA SUP.
		T42117	TENSOR- POLEA DE DIST.	POLEA LOCA INF.
		T41210	TENSOR- POLEA DE DIST.	(DEL TENSOR)
V6. 2.5 L	2001	T42009	TENSOR- POLEA DE DIST.	POLEA LOCA INF.

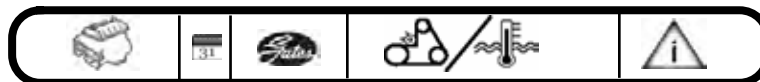

V6. 2.3 L	2000	T41034	TENSOR- POLEA DE DIST.	(DEL TENSOR)
		T42010	TENSOR- POLEA DE DIST.	POLEA LOCA SUP.
		T41210	TENSOR- POLEA DE DIST.	(DEL TENSOR)
		T42117	TENSOR- POLEA DE DIST.	POLEA LOCA INF.
		T42010	TENSOR- POLEA DE DIST.	POLEA LOCA SUP.
V6. 2.5 L	2000	T42010	TENSOR- POLEA DE DIST.	POLEA LOCA SUP.
		T41034	TENSOR- POLEA DE DIST.	(DEL TENSOR)
		T42009	TENSOR- POLEA DE DIST.	POLEA LOCA INF.
V6. 2.3 L	1999	T42010	TENSOR- POLEA DE DIST.	POLEA LOCA SUP.
		T41210	TENSOR- POLEA DE DIST.	(DEL TENSOR)
		T42117	TENSOR- POLEA DE DIST.	POLEA LOCA INF.
V6. 2.5 L	1999	T41034	TENSOR- POLEA DE DIST.	(DEL TENSOR)
		T42010	TENSOR- POLEA DE DIST.	POLEA LOCA SUP.
		T42009	TENSOR- POLEA DE DIST.	POLEA LOCA INF.
V6. 2.3 L	1998	T42010	TENSOR- POLEA DE DIST.	POLEA LOCA SUP.
		T41210	TENSOR- POLEA DE DIST.	(DEL TENSOR)
		T42117	TENSOR- POLEA DE DIST.	POLEA LOCA INF.
V6. 2.5 L	1998	T42009	TENSOR- POLEA DE DIST.	POLEA LOCA INF.
		T41034	TENSOR- POLEA DE DIST.	(DEL TENSOR)
		T42010	TENSOR- POLEA DE DIST.	POLEA LOCA SUP.
V6. 2.3 L	1997	T41210	TENSOR- POLEA DE DIST.	(DEL TENSOR)
		T42117	TENSOR- POLEA DE DIST.	POLEA LOCA INF.
		T42010	TENSOR- POLEA DE DIST.	POLEA LOCA SUP.
V6. 2.5 L	1997	T42009	TENSOR- POLEA DE DIST.	POLEA LOCA INF.
		T41034	TENSOR- POLEA DE DIST.	(DEL TENSOR)
		T42010	TENSOR- POLEA DE DIST.	POLEA LOCA SUP.
V6. 2.3 L	1996	T41210	TENSOR- POLEA DE DIST.	(DEL TENSOR)
		T42010	TENSOR- POLEA DE DIST.	POLEA LOCA SUP.
		T42117	TENSOR- POLEA DE DIST.	POLEA LOCA INF.
V6. 2.5 L	1996	T41034	TENSOR- POLEA DE DIST.	(DEL TENSOR)
		T42009	TENSOR- POLEA DE DIST.	POLEA LOCA INF.
		T42010	TENSOR- POLEA DE DIST.	POLEA LOCA SUP.
V6. 2.3 L	1995	T41210	TENSOR- POLEA DE DIST.	(DEL TENSOR)
		T42117	TENSOR- POLEA DE DIST.	POLEA LOCA INF.
		T42010	TENSOR- POLEA DE DIST.	POLEA LOCA SUP.
V6. 2.5 L	1995	T41034	TENSOR- POLEA DE DIST.	(DEL TENSOR)
		T42009	TENSOR- POLEA DE DIST.	POLEA LOCA INF.
		T42010	TENSOR- POLEA DE DIST.	POLEA LOCA SUP.

**MPV**

V6. 3.0 L	1998	T42011	TENSOR- POLEA DE DIST.	POLEA TENSORA
		T41033	TENSOR- POLEA DE DIST.	
		T41033	TENSOR- POLEA DE DIST.	
		T42001	TENSOR- POLEA DE DIST.	POLEA LOCA INF.
		T42011	TENSOR- POLEA DE DIST.	POLEA LOCA SUP.
V6. 3.0 L	1997	T41033	TENSOR- POLEA DE DIST.	
		T42011	TENSOR- POLEA DE DIST.	POLEA TENSORA
		T41033	TENSOR- POLEA DE DIST.	
		T42011	TENSOR- POLEA DE DIST.	POLEA LOCA SUP.
		T42001	TENSOR- POLEA DE DIST.	POLEA LOCA INF.
V6. 3.0 L	1996	T42011	TENSOR- POLEA DE DIST.	POLEA TENSORA
		T42011	TENSOR- POLEA DE DIST.	POLEA LOCA SUP.
		T41033	TENSOR- POLEA DE DIST.	
		T42001	TENSOR- POLEA DE DIST.	POLEA LOCA INF.
V6. 3.0 L	1995	T41033	TENSOR- POLEA DE DIST.	
		T41033	TENSOR- POLEA DE DIST.	
		T42001	TENSOR- POLEA DE DIST.	POLEA LOCA INF.
		T42011	TENSOR- POLEA DE DIST.	POLEA LOCA SUP.
		T42011	TENSOR- POLEA DE DIST.	POLEA TENSORA
		T41033	TENSOR- POLEA DE DIST.	POLEA LOCA SUP.
V6. 3.0 L	1994	T42011	TENSOR- POLEA DE DIST.	POLEA LOCA SUP.
		T41033	TENSOR- POLEA DE DIST.	
		T42001	TENSOR- POLEA DE DIST.	POLEA LOCA INF.
		T41033	TENSOR- POLEA DE DIST.	
		T42011	TENSOR- POLEA DE DIST.	POLEA TENSORA
		T41033	TENSOR- POLEA DE DIST.	POLEA LOCA SUP.
V6. 3.0 L	1993	T42001	TENSOR- POLEA DE DIST.	POLEA LOCA INF.
		T41033	TENSOR- POLEA DE DIST.	
		T42011	TENSOR- POLEA DE DIST.	POLEA LOCA SUP.
		T41033	TENSOR- POLEA DE DIST.	
		T42011	TENSOR- POLEA DE DIST.	POLEA TENSORA
V6. 3.0 L	1992	T41033	TENSOR- POLEA DE DIST.	
		T41033	TENSOR- POLEA DE DIST.	

V6, 3.0 L	1992	T42011	SENSOR- POLEA DE DIST.	POLEA TENSORA
		T42011	SENSOR- POLEA DE DIST.	POLEA LOCA SUP.
		T42001	SENSOR- POLEA DE DIST.	POLEA LOCA INF.
V6, 3.0 L	1991	T42011	SENSOR- POLEA DE DIST.	POLEA LOCA SUP.
		T41033	SENSOR- POLEA DE DIST.	
		T42001	SENSOR- POLEA DE DIST.	POLEA LOCA INF.
V6, 3.0 L	1990	T42001	SENSOR- POLEA DE DIST.	POLEA LOCA INF.
		T42011	SENSOR- POLEA DE DIST.	POLEA LOCA SUP.
		T41033	SENSOR- POLEA DE DIST.	
V6, 3.0 L	1989	T42001	SENSOR- POLEA DE DIST.	POLEA LOCA INF.
		T41033	SENSOR- POLEA DE DIST.	
		T42011	SENSOR- POLEA DE DIST.	POLEA LOCA SUP.

<b>PROTEGE</b>				
4 CIL. 2.0 L	2003	T42008	SENSOR- POLEA DE DIST.	POLEA LOCA
		T41091	SENSOR- POLEA DE DIST.	
4 CIL. 2.0 L	2002	T42008	SENSOR- POLEA DE DIST.	POLEA LOCA
		T41091	SENSOR- POLEA DE DIST.	
4 CIL. 2.0 L	2001	T41091	SENSOR- POLEA DE DIST.	
		T42008	SENSOR- POLEA DE DIST.	POLEA LOCA
4 CIL. 1.5 L	1998	T42116	SENSOR- POLEA DE DIST.	POLEA LOCA SUP.
4 CIL. 1.5 L	1997	T42116	SENSOR- POLEA DE DIST.	POLEA LOCA SUP.
4 CIL. 1.5 L	1996	T42116	SENSOR- POLEA DE DIST.	POLEA LOCA SUP.
4 CIL. 1.5 L	1995	T42116	SENSOR- POLEA DE DIST.	POLEA LOCA SUP.
4 CIL. 1.8 L	1995	T41030	SENSOR- POLEA DE DIST.	
4 CIL. 1.8 L	1994	T41030	SENSOR- POLEA DE DIST.	
4 CIL. 1.8 L	1993	T41030	SENSOR- POLEA DE DIST.	
4 CIL. 1.8 L	1992	T41030	SENSOR- POLEA DE DIST.	
4 CIL. 1.8 L	1991	T41030	SENSOR- POLEA DE DIST.	
4 CIL. 1.8 L	1990	T41030	SENSOR- POLEA DE DIST.	

**MX-3**

V6, 1.8 L (Canada)	1995	T42010	SENSOR- POLEA DE DIST.	POLEA LOCA SUP.
		T42009	SENSOR- POLEA DE DIST.	POLEA LOCA INF.
		T41034	SENSOR- POLEA DE DIST.	(DEL TENSOR)
V6, 1.8 L	1994	T41034	SENSOR- POLEA DE DIST.	(DEL TENSOR)
		T42010	SENSOR- POLEA DE DIST.	POLEA LOCA SUP.
		T42009	SENSOR- POLEA DE DIST.	POLEA LOCA INF.
4 CIL. 1.6 L	1993	T41030	SENSOR- POLEA DE DIST.	
V6, 1.8 L	1993	T42009	SENSOR- POLEA DE DIST.	POLEA LOCA INF.
		T41034	SENSOR- POLEA DE DIST.	(DEL TENSOR)
		T42010	SENSOR- POLEA DE DIST.	POLEA LOCA SUP.
4 CIL. 1.6 L	1992	T41030	SENSOR- POLEA DE DIST.	
V6, 1.8 L	1992	T42010	SENSOR- POLEA DE DIST.	POLEA LOCA SUP.
		T41034	SENSOR- POLEA DE DIST.	(DEL TENSOR)
		T42009	SENSOR- POLEA DE DIST.	POLEA LOCA INF.

**MX-5 MIATA**

4 CIL. 2.0 L	2007	38008	TENSOR
4 CIL. 2.0 L	2006	38008	TENSOR

**MX-6**

4 CIL. 2.0 L	1997	T42008	SENSOR- POLEA DE DIST.	POLEA LOCA
		T41091	SENSOR- POLEA DE DIST.	
V6, 2.5 L	1997	T42010	SENSOR- POLEA DE DIST.	POLEA LOCA SUP.
		T41034	SENSOR- POLEA DE DIST.	(DEL TENSOR)
		T42009	SENSOR- POLEA DE DIST.	POLEA LOCA INF.
4 CIL. 2.0 L	1996	T41091	SENSOR- POLEA DE DIST.	
		T42008	SENSOR- POLEA DE DIST.	POLEA LOCA
V6, 2.5 L	1996	T42010	SENSOR- POLEA DE DIST.	POLEA LOCA SUP.
		T42009	SENSOR- POLEA DE DIST.	POLEA LOCA INF.
		T41034	SENSOR- POLEA DE DIST.	(DEL TENSOR)
4 CIL. 2.0 L	1995	T42008	SENSOR- POLEA DE DIST.	POLEA LOCA
		T41091	SENSOR- POLEA DE DIST.	
V6, 2.5 L	1995	T41034	SENSOR- POLEA DE DIST.	(DEL TENSOR)
		T42009	SENSOR- POLEA DE DIST.	POLEA LOCA INF.
		T42010	SENSOR- POLEA DE DIST.	POLEA LOCA SUP.
4 CIL. 2.0 L	1994	T41091	SENSOR- POLEA DE DIST.	
		T42008	SENSOR- POLEA DE DIST.	POLEA LOCA
V6, 2.5 L	1994	T42010	SENSOR- POLEA DE DIST.	POLEA LOCA SUP.
		T41034	SENSOR- POLEA DE DIST.	(DEL TENSOR)
		T42009	SENSOR- POLEA DE DIST.	POLEA LOCA INF.
4 CIL. 2.0 L	1993	T42008	SENSOR- POLEA DE DIST.	POLEA LOCA
		T41091	SENSOR- POLEA DE DIST.	
V6, 2.5 L	1993	T42010	SENSOR- POLEA DE DIST.	POLEA LOCA SUP.
		T42009	SENSOR- POLEA DE DIST.	POLEA LOCA INF.
		T41034	SENSOR- POLEA DE DIST.	(DEL TENSOR)
4 CIL. 2.2 L	1992	T42003	SENSOR- POLEA DE DIST.	POLEA LOCA
		T41029	SENSOR- POLEA DE DIST.	
4 CIL. 2.2 L	1991	T41029	SENSOR- POLEA DE DIST.	
		T42003	SENSOR- POLEA DE DIST.	POLEA LOCA
4 CIL. 2.2 L	1990	T42003	SENSOR- POLEA DE DIST.	POLEA LOCA
		T41029	SENSOR- POLEA DE DIST.	
4 CIL. 2.2 L	1989	T41029	SENSOR- POLEA DE DIST.	
		T42003	SENSOR- POLEA DE DIST.	POLEA LOCA
4 CIL. 2.2 L	1988	T42003	SENSOR- POLEA DE DIST.	POLEA LOCA
		T41029	SENSOR- POLEA DE DIST.	

**MERCEDES-BENZ**

**190D**

5 CIL. 2.5 L Diesel	1989	38048	POLEA	POLEA LOCA
5 CIL. 2.5 L Diesel	1988	38048	POLEA	POLEA LOCA
5 CIL. 2.5 L Diesel	1987	38048	POLEA	POLEA LOCA
5 CIL. 2.5 L Diesel	1986	38048	POLEA	POLEA LOCA
4 CIL. 2.2 L Diesel	1985	38048	POLEA	POLEA LOCA
4 CIL. 2.2 L Diesel	1984	38048	POLEA	POLEA LOCA

**190E**

4 CIL. 2.3 L	1993	38264	TENSOR PARA BANDA MICRO-V	
6 CIL. 2.6 L	1993	38263	TENSOR PARA BANDA MICRO-V	
4 CIL. 2.3 L	1992	38264	TENSOR PARA BANDA MICRO-V	
6 CIL. 2.6 L	1992	38047	POLEA	DEL TENSOR
		38263	TENSOR PARA BANDA MICRO-V	
4 CIL. 2.3 L	1991	38264	TENSOR PARA BANDA MICRO-V	
6 CIL. 2.6 L	1991	38047	POLEA	DEL TENSOR
		38263	TENSOR PARA BANDA MICRO-V	
6 CIL. 2.6 L	1990	38047	TENSOR PARA BANDA MICRO-V	DEL TENSOR
		38263	TENSOR PARA BANDA MICRO-V	
6 CIL. 2.6 L	1989	38047	POLEA	DEL TENSOR
		38263	TENSOR PARA BANDA MICRO-V	
4 CIL. 2.3 L	1988	38048	POLEA	POLEA LOCA
		38264	TENSOR PARA BANDA MICRO-V	
6 CIL. 2.6 L	1988	38047	POLEA	DEL TENSOR
		38263	TENSOR PARA BANDA MICRO-V	
4 CIL. 2.3 L	1987	38048	POLEA	POLEA LOCA
		38264	TENSOR PARA BANDA MICRO-V	
6 CIL. 2.6 L	1987	38092	POLEA	POLEA LOCA
		38047	POLEA	DEL TENSOR
		38263	TENSOR PARA BANDA MICRO-V	
4 CIL. 2.3 L	1986	38048	POLEA	POLEA LOCA
		38264	TENSOR PARA BANDA MICRO-V	
4 CIL. 2.3 L	1985	38264	TENSOR PARA BANDA MICRO-V	

**260E**

6 CIL. 2.6 L	1989	38047	POLEA	DEL TENSOR
		38092	POLEA	POLEA LOCA
		38263	TENSOR PARA BANDA MICRO-V	
6 CIL. 2.6 L	1988	38047	POLEA	DEL TENSOR
		38092	POLEA	POLEA LOCA
		38263	TENSOR PARA BANDA MICRO-V	
6 CIL. 2.6 L	1987	38047	POLEA	DEL TENSOR
		38092	POLEA	POLEA LOCA
		38263	TENSOR PARA BANDA MICRO-V	

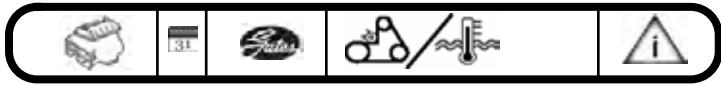

**300CE**

6 CIL. 3.2 L	1993	38263	TENSOR PARA BANDA MICRO-V	
6 CIL. 3.0 L	1992	38092	POLEA	POLEA LOCA
		38047	POLEA	DEL TENSOR
		38263	TENSOR PARA BANDA MICRO-V	
6 CIL. 3.0 L	1991	38092	POLEA	POLEA LOCA
		38047	POLEA	DEL TENSOR
		38263	TENSOR PARA BANDA MICRO-V	
6 CIL. 3.0 L	1990	38047	POLEA	DEL TENSOR
		38092	POLEA	POLEA LOCA
		38263	TENSOR PARA BANDA MICRO-V	
6 CIL. 3.0 L	1989	38092	POLEA	POLEA LOCA
		38047	POLEA	DEL TENSOR
		38263	TENSOR PARA BANDA MICRO-V	
6 CIL. 3.0 L	1988	38092	POLEA	POLEA LOCA
		38047	POLEA	DEL TENSOR
		38263	TENSOR PARA BANDA MICRO-V	

**300SEL**

6 CIL. 3.0 L	1991	38047	POLEA	DEL TENSOR
		38263	TENSOR PARA BANDA MICRO-V	
6 CIL. 3.0 L	1990	38047	POLEA	DEL TENSOR
		38263	TENSOR PARA BANDA MICRO-V	
6 CIL. 3.0 L	1989	38092	POLEA	POLEA LOCA
		38263	TENSOR PARA BANDA MICRO-V	
6 CIL. 3.0 L	1988	38092	POLEA	POLEA LOCA
		38263	TENSOR PARA BANDA MICRO-V	

**300SL**

6 CIL. 3.0 L	1993	38047	POLEA	DEL TENSOR
		38263	TENSOR PARA BANDA MICRO-V	
6 CIL. 3.0 L	1992	38047	POLEA	DEL TENSOR
		38263	TENSOR PARA BANDA MICRO-V	
6 CIL. 3.0 L	1991	38047	POLEA	DEL TENSOR
		38263	TENSOR PARA BANDA MICRO-V	
6 CIL. 3.0 L	1990	38047	POLEA	DEL TENSOR
		38263	TENSOR PARA BANDA MICRO-V	

**300E**

6 CIL. 2.8 L	1993	38211	TENSOR PARA BANDA MICRO-V	
		38263	TENSOR PARA BANDA MICRO-V	
6 CIL. 3.0 L	1993	38263	TENSOR PARA BANDA MICRO-V	
6 CIL. 3.2 L	1993	38211	TENSOR PARA BANDA MICRO-V	
		38263	TENSOR PARA BANDA MICRO-V	
6 CIL. 2.6 L	1992	38092	POLEA	POLEA LOCA
		38047	POLEA	DEL TENSOR
		38263	TENSOR PARA BANDA MICRO-V	
6 CIL. 3.0 L	1992	38092	POLEA	POLEA LOCA
		38047	POLEA	DEL TENSOR
		38263	TENSOR PARA BANDA MICRO-V	
6 CIL. 2.6 L	1991	38047	POLEA	DEL TENSOR
		38092	POLEA	POLEA LOCA
		38263	TENSOR PARA BANDA MICRO-V	
6 CIL. 3.0 L	1991	38047	POLEA	DEL TENSOR
		38092	POLEA	POLEA LOCA
		38263	TENSOR PARA BANDA MICRO-V	
6 CIL. 2.6 L	1990	38092	POLEA	POLEA LOCA
		38047	POLEA	DEL TENSOR
		38263	TENSOR PARA BANDA MICRO-V	
6 CIL. 3.0 L	1990	38092	POLEA	POLEA LOCA
		38047	POLEA	DEL TENSOR
		38263	TENSOR PARA BANDA MICRO-V	
6 CIL. 3.0 L	1989	38092	POLEA	POLEA LOCA
		38047	POLEA	DEL TENSOR
		38263	TENSOR PARA BANDA MICRO-V	
6 CIL. 3.0 L	1988	38047	POLEA	DEL TENSOR
		38092	POLEA	POLEA LOCA
		38263	TENSOR PARA BANDA MICRO-V	
6 CIL. 3.0 L	1987	38092	POLEA	POLEA LOCA
		38047	POLEA	DEL TENSOR
		38263	TENSOR PARA BANDA MICRO-V	
6 CIL. 3.0 L	1986	38047	POLEA	DEL TENSOR
		38092	POLEA	POLEA LOCA
		38263	TENSOR PARA BANDA MICRO-V	

**300TE**

6 CIL. 3.0 L	1993	38263	TENSOR PARA BANDA MICRO-V	
6 CIL. 3.2 L	1993	38263	TENSOR PARA BANDA MICRO-V	
		38211	TENSOR PARA BANDA MICRO-V	
6 CIL. 3.0 L	1992	38047	POLEA	DEL TENSOR
		38263	TENSOR PARA BANDA MICRO-V	
6 CIL. 3.0 L	1991	38047	POLEA	DEL TENSOR
		38263	TENSOR PARA BANDA MICRO-V	
6 CIL. 3.0 L	1990	38047	POLEA	DEL TENSOR
		38263	TENSOR PARA BANDA MICRO-V	
6 CIL. 3.0 L	1989	38047	POLEA	DEL TENSOR
		38263	TENSOR PARA BANDA MICRO-V	
6 CIL. 3.0 L	1988	38047	POLEA	DEL TENSOR
		38263	TENSOR PARA BANDA MICRO-V	

**500SL**

V8. 5.0 L	1993	38048	POLEA	POLEA LOCA
V8. 5.0 L	1992	38048	POLEA	POLEA LOCA
		38084	POLEA	DEL TENSOR
V8. 5.0 L	1991	38084	POLEA	DEL TENSOR
V8. 5.0 L	1990	38084	POLEA	DEL TENSOR

**C240**

V6. 2.6 L	2005	38174	TENSOR	
		38082	TENSOR	
V6. 2.6 L	2004	38174	TENSOR	
		38082	TENSOR	
V6. 2.6 L	2003	38174	TENSOR	
		38082	TENSOR	
V6. 2.6 L	2002	38082	TENSOR	
		38174	TENSOR	
V6. 2.6 L	2001	38174	TENSOR	
		38082	TENSOR	

**300SE**

6 CIL. 3.2 L	1992	38263	TENSOR PARA BANDA MICRO-V	
6 CIL. 3.0 L	1991	38047	POLEA	DEL TENSOR
		38092	POLEA	POLEA LOCA
		38263	TENSOR PARA BANDA MICRO-V	
6 CIL. 3.0 L	1990	38047	POLEA	DEL TENSOR
		38092	POLEA	POLEA LOCA
		38263	TENSOR PARA BANDA MICRO-V	
6 CIL. 3.0 L	1989	38047	POLEA	DEL TENSOR
		38092	POLEA	POLEA LOCA
		38263	TENSOR PARA BANDA MICRO-V	
6 CIL. 3.0 L	1988	38047	POLEA	DEL TENSOR
		38092	POLEA	POLEA LOCA
		38263	TENSOR PARA BANDA MICRO-V	

**C280**

V6. 2.8 L	2000	38082	TENSOR	
		38174	TENSOR	
V6. 2.8 L	1999	38082	TENSOR	
		38174	TENSOR	
V6. 2.8 L	1998	38082	TENSOR	
		38174	TENSOR	
6 CIL. 2.8 L	1997	38047	POLEA	DEL TENSOR
		38263	TENSOR PARA BANDA MICRO-V	
6 CIL. 2.8 L	1996	38047	POLEA	DEL TENSOR
		38263	TENSOR PARA BANDA MICRO-V	
6 CIL. 2.8 L	1995	38047	POLEA	DEL TENSOR
		38263	TENSOR PARA BANDA MICRO-V	



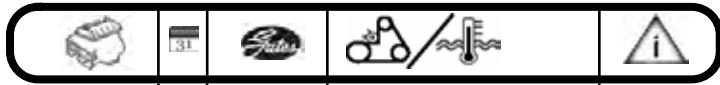

6 CIL. 2.8 L | 1994 | 38263 | TENSOR PARA BANDA MICRO-V



V8, 5.0 L | 2003 | 38082 | TENSOR  
38174 | TENSOR  
38082 | TENSOR

**C320**

V6, 3.2 L	2005	38174	TENSOR
		38082	TENSOR
V6, 3.2 L	2004	38174	TENSOR
		38082	TENSOR
V6, 3.2 L	2003	38082	TENSOR
		38174	TENSOR
V6, 3.2 L	2002	38082	TENSOR
		38174	TENSOR
V6, 3.2 L	2001	38174	TENSOR
		38082	TENSOR

**CLK55**

V8, 5.5 L	2006	38174	TENSOR
V8, 5.5 L	2005	38174	TENSOR
		38082	TENSOR
V8, 5.5 L	2004	38174	TENSOR
		38082	TENSOR
V8, 5.5 L	2003	38174	TENSOR
		38082	TENSOR
V8, 5.5 L	2002	38174	TENSOR
		38082	TENSOR
V8, 5.5 L	2001	38174	TENSOR

**CL500**

V8, 5.0 L	2005	38082	TENSOR
		38174	TENSOR
V8, 5.0 L	2004	38082	TENSOR
		38174	TENSOR
V8, 5.0 L	2003	38174	TENSOR
		38082	TENSOR
V8, 5.0 L	2002	38082	TENSOR
		38174	TENSOR
V8, 5.0 L	2001	38082	TENSOR
		38174	TENSOR
V8, 5.0 L	2000	38082	TENSOR
		38174	TENSOR

**E320**

V6, 3.2 L	2006	38174	TENSOR
		38082	TENSOR
V6, 3.2 L	2005	38174	TENSOR
		38082	TENSOR
V6, 3.2 L	2004	38082	TENSOR
		38174	TENSOR
V6, 3.2 L	2003	38174	TENSOR
		38082	TENSOR
V6, 3.2 L	2002	38082	TENSOR
		38174	TENSOR
V6, 3.2 L	2001	38082	TENSOR
		38174	TENSOR
6 CIL. 3.2 L	1996	38047	POLEA
6 CIL. 3.2 L	1995	38047	POLEA
		38211	TENSOR PARA BANDA MICRO-V
		38263	TENSOR PARA BANDA MICRO-V
6 CIL. 3.2 L	1994	38047	POLEA
		38263	TENSOR PARA BANDA MICRO-V
		38211	TENSOR PARA BANDA MICRO-V

**CL55**

V8, 5.5 L	2006	38082	TENSOR
		38174	TENSOR
V8, 5.5 L	2005	38174	TENSOR
		38082	TENSOR
V8, 5.5 L	2004	38174	TENSOR
		38082	TENSOR
V8, 5.5 L	2003	38082	TENSOR
		38174	TENSOR
V8, 5.5 L	2002	38174	TENSOR
		38082	TENSOR
V8, 5.5 L	2001	38082	TENSOR
		38174	TENSOR

**E430**

V8, 4.3 L	2001	38082	TENSOR
		38174	TENSOR

**E55**

V8, 5.5 L	2002	38174	TENSOR
		38082	TENSOR
V8, 5.5 L	2001	38174	TENSOR
		38082	TENSOR

**CLK320**

V6, 3.2 L	2005	38174	TENSOR
		38082	TENSOR
V6, 3.2 L	2004	38082	TENSOR
		38174	TENSOR
V6, 3.2 L	2003	38174	TENSOR
		38082	TENSOR
V6, 3.2 L	2002	38082	TENSOR
		38174	TENSOR
V6, 3.2 L	2001	38082	TENSOR
		38174	TENSOR

**ML320**

V6, 3.2 L	2003	38174	TENSOR
		38082	TENSOR
V6, 3.2 L	2002	38174	TENSOR
		38082	TENSOR
V6, 3.2 L	2001	38174	TENSOR
		38082	TENSOR

**CLK430**

V8, 4.3 L	2003	38174	TENSOR
		38082	TENSOR
V8, 4.3 L	2002	38082	TENSOR
		38174	TENSOR
V8, 4.3 L	2001	38082	TENSOR
		38174	TENSOR
V8, 4.3 L	2000	38082	TENSOR
		38174	TENSOR

**CLK500**

V8, 5.0 L	2005	38174	TENSOR
		38082	TENSOR
V8, 5.0 L	2004	38174	TENSOR

**S320**

6 CIL. 3.2 L	1999	38047	POLEA
		38211	TENSOR PARA BANDA MICRO-V
		38263	TENSOR PARA BANDA MICRO-V
6 CIL. 3.2 L	1998	38047	POLEA
		38263	TENSOR PARA BANDA MICRO-V
		38211	TENSOR PARA BANDA MICRO-V
6 CIL. 3.2 L	1997	38047	POLEA
		38263	TENSOR PARA BANDA MICRO-V
		38211	TENSOR PARA BANDA MICRO-V
6 CIL. 3.2 L	1996	38047	POLEA
		38263	TENSOR PARA BANDA MICRO-V
		38211	TENSOR PARA BANDA MICRO-V

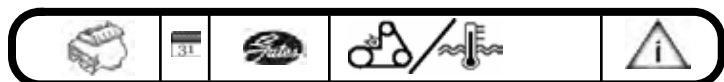

6 CIL. 3.2 L	1995	38047	POLEA	DEL TENSOR
		38263	TENSOR PARA BANDA MICRO-V	
		38211	TENSOR PARA BANDA MICRO-V	
6 CIL. 3.2 L	1994	38047	POLEA	DEL TENSOR
		38211	TENSOR PARA BANDA MICRO-V	
		38263	TENSOR PARA BANDA MICRO-V	



V8, 5.0 L	2001	38082	TENSOR	
		38082	TENSOR	
		38174	TENSOR	
V8, 5.0 L	1997	38048	POLEA	POLEA LOCA
V8, 5.0 L	1996	38048	POLEA	POLEA LOCA
V8, 5.0 L	1995	38048	POLEA	POLEA LOCA
V8, 5.0 L	1994	38048	POLEA	POLEA LOCA

**S430**

V8, 4.3 L	2005	38174	TENSOR	
		38082	TENSOR	
V8, 4.3 L	2004	38174	TENSOR	
		38082	TENSOR	
V8, 4.3 L	2003	38082	TENSOR	
		38174	TENSOR	
V8, 4.3 L	2002	38174	TENSOR	
		38082	TENSOR	
V8, 4.3 L	2001	38174	TENSOR	
		38082	TENSOR	

**SL55**

V8, 5.5 L	2006	38174	TENSOR	ALT. B. AGUA Y D.H.
V8, 5.5 L	2005	38174	TENSOR	ALT. B. AGUA Y D.H.
V8, 5.5 L	2004	38174	TENSOR	ALT. B. AGUA Y D.H.
V8, 5.5 L	2003	38174	TENSOR	ALT. B. AGUA Y D.H.

**SL600**

V12, 6.0 L	2001	38090	POLEA	
		38090	TENSOR	
V12, 6.0 L	1999	38091	POLEA	POLEA LOCA
V12, 6.0 L	1998	38091	POLEA	POLEA LOCA
V12, 6.0 L	1997	38091	POLEA	POLEA LOCA
V12, 6.0 L	1996	38091	POLEA	POLEA LOCA
V12, 6.0 L	1995	38091	POLEA	POLEA LOCA
V12, 6.0 L	1994	38091	POLEA	POLEA LOCA

**S500**

V8, 5.0 L	2005	38082	TENSOR	
		38174	TENSOR	
V8, 5.0 L	2004	38174	TENSOR	
		38082	TENSOR	
V8, 5.0 L	2003	38082	TENSOR	
		38174	TENSOR	
V8, 5.0 L	2002	38082	TENSOR	
		38174	TENSOR	
V8, 5.0 L	2001	38082	TENSOR	
		38174	TENSOR	

**SLK230**

4 CIL. 2.3 L	2004	38225	TENSOR	A.A. Y D.H.
		38225	TENSOR PARA BANDA MICRO-V	A.A. Y D.H.
4 CIL. 2.3 L	2003	38225	TENSOR	A.A. Y D.H.
4 CIL. 2.3 L	2002	38225	TENSOR	A.A. Y D.H.
4 CIL. 2.3 L	2001	38225	TENSOR	A.A. Y D.H.

**S55**

V8, 5.5 L	2005	38174	TENSOR	ALT. B. AGUA Y D.H.
V8, 5.5 L	2004	38174	TENSOR	ALT. B. AGUA Y D.H.
V8, 5.5 L	2003	38174	TENSOR	ALT. B. AGUA Y D.H.
V8, 5.5 L	2002	38174	TENSOR	
		38082	TENSOR	
V8, 5.5 L	2001	38082	TENSOR	
		38174	TENSOR	

**SLK320**

V6, 3.2 L	2004	38174	TENSOR	
		38082	TENSOR	
V6, 3.2 L	2003	38082	TENSOR	
		38174	TENSOR	
V6, 3.2 L	2002	38174	TENSOR	
		38082	TENSOR	
V6, 3.2 L	2001	38174	TENSOR	
		38082	TENSOR	

**S600**

V12, 6.0 L	1999	38091	POLEA	POLEA LOCA
V12, 6.0 L	1998	38091	POLEA	POLEA LOCA
V12, 6.0 L	1997	38091	POLEA	POLEA LOCA
V12, 6.0 L	1996	38091	POLEA	POLEA LOCA
V12, 6.0 L	1995	38091	POLEA	POLEA LOCA
V12, 6.0 L	1994	38091	POLEA	POLEA LOCA

**SLK350**

V6, 3.5 L	2005	38082	TENSOR	SUP.
-----------	------	-------	--------	------

**SPRINTER**

4 CIL. 2.2 L CDI	2010	38415	TENSOR	
		38099	TENSOR	2 PZAS.
4 CIL. 2.2 L CDI	2009	38099	TENSOR	2 PZAS.
		38415	TENSOR	
4 CIL. 2.2 L CDI	2008	38099	TENSOR	2 PZAS.
		38415	TENSOR	
4 CIL. 2.2 L	2007	T38415	TENSOR- POLEA DE DIST.	C/AA
4 CIL. 2.2 L CDI	2007	38099	POLEA	
		38099	TENSOR	
		38415	TENSOR PARA BANDA MICRO-V	
		T38415	TENSOR- POLEA DE DIST.	
4 CIL. 2.2 L CDI	2006	38099	TENSOR	
		T38415	TENSOR- POLEA DE DIST.	
5 CIL. 2.7 L CDI	2005	38099	TENSOR	
		T38415	TENSOR- POLEA DE DIST.	
5 CIL. 2.7 L CDI	2004	38099	TENSOR	
		T38415	TENSOR- POLEA DE DIST.	
5 CIL. 2.7 L CDI	2003	38099	TENSOR	
		T38415	TENSOR- POLEA DE DIST.	

**SL320**

6 CIL. 3.2 L	1997	38263	TENSOR PARA BANDA MICRO-V	
6 CIL. 3.2 L	1996	38047	POLEA	DEL TENSOR
		38263	TENSOR PARA BANDA MICRO-V	
		38211	TENSOR PARA BANDA MICRO-V	
6 CIL. 3.2 L	1995	38047	POLEA	DEL TENSOR
		38263	TENSOR PARA BANDA MICRO-V	
		38211	TENSOR PARA BANDA MICRO-V	
6 CIL. 3.2 L	1994	38047	POLEA	DEL TENSOR
		38211	TENSOR PARA BANDA MICRO-V	
		38263	TENSOR PARA BANDA MICRO-V	

**SL500**

V8, 5.0 L	2005	38174	TENSOR	
		38082	TENSOR	
V8, 5.0 L	2004	38082	TENSOR	
		38174	TENSOR	
V8, 5.0 L	2003	38174	TENSOR	
		38082	TENSOR	
V8, 5.0 L	2002	38174	TENSOR	

**VITO**

4 CIL. 2.2 L	2010	38415	TENSOR	
		38099	TENSOR	2 PZAS.

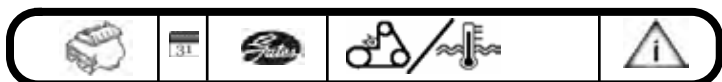

4 CIL. 2.2 L	2009	38415	TENSOR	
		38099	TENSOR	2 PZAS.
4 CIL. 2.2 L	2008	38099	TENSOR	2 PZAS.
		38415	TENSOR	



4 CIL. 2.3 L	2006	38279	TENSOR	
		38408	TENSOR	
4 CIL. 2.3 L	2005	38408	TENSOR	

## MERCURY

### CAPRI

4 CIL. 2.3 L	1986	38035	POLEA	POLEA LOCA
V6. 3.8 L	1986	38050	POLEA	POLEA LOCA
4 CIL. 2.3 L	1985	38035	POLEA	POLEA LOCA
V6. 3.8 L	1985	38050	POLEA	POLEA LOCA
4 CIL. 2.3 L	1984	38035	POLEA	POLEA LOCA
4 CIL. 2.3 L	1983	38035	POLEA	POLEA LOCA
4 CIL. 2.3 L	1982	38035	POLEA	POLEA LOCA
4 CIL. 2.3 L	1981	38035	POLEA	POLEA LOCA

### COUGAR

V8. 5.0 L	1992	38249	TENSOR PARA BANDA MICRO-V	
V6. 3.8 L	1988	38050	POLEA	POLEA LOCA
V6. 3.8 L	1987	38050	POLEA	POLEA LOCA
V6. 3.8 L	1986	38050	POLEA	POLEA LOCA
V6. 3.8 L	1985	38050	POLEA	POLEA LOCA

### COUGAR XR7

V6. 3.8 L	1994	38009	TENSOR	
		38127	TENSOR	
		38007	TENSOR	
V6. 3.8 L	1993	38007	TENSOR	
		38127	TENSOR	
		38009	TENSOR	

### GRAND MARQUIS

V8. 4.6 L	2005	38006	TENSOR	
		38189	TENSOR	
V8. 4.6 L	2004	36100	POLEA	
		38189	TENSOR	
V8. 4.6 L	2003	36100	POLEA	CON CANALES
		38189	TENSOR	
V8. 4.6 L	2002	38189	TENSOR	
V8. 4.6 L	2001	38189	TENSOR	
V8. 4.6 L	2000	38189	TENSOR	
V8. 4.6 L	1999	38132	TENSOR	
		38006	TENSOR	
V8. 4.6 L	1998	38006	TENSOR	
		38132	TENSOR	
V8. 4.6 L	1997	38132	TENSOR	
		38006	TENSOR	
V8. 4.6 L	1996	38132	TENSOR	
		38006	TENSOR	
V8. 4.6 L	1995	38132	TENSOR	
		38006	TENSOR	
V8. 4.6 L	1994	38006	TENSOR	
		38132	TENSOR	
V8. 4.6 L	1993	38006	TENSOR	
		38132	TENSOR	

### MARINER

V6. 3.0 L	2009	91030	HERRAMIENTA INST. STRECH FIT	
		38006	TENSOR	
		38279	TENSOR	
V6. 3.0 L	2008	91030	HERRAMIENTA INST. STRECH FIT	
		38006	TENSOR	
		38279	TENSOR	
4 CIL. 2.3 L	2007	38408	TENSOR	
V6. 3.0 L	2007	91030	HERRAMIENTA INST. STRECH FIT	

## MILAN

4 CIL. 2.5 L	2010	38452	TENSOR	
V6. 3.0 L	2009	91030	HERRAMIENTA INST. STRECH FIT	RANURADA
		38008	TENSOR	
		38279	TENSOR	
		38006	TENSOR	LISA
V6. 3.0 L	2008	91030	HERRAMIENTA INST. STRECH FIT	
V6. 3.0 L	2007	91030	HERRAMIENTA INST. STRECH FIT	
		38006	TENSOR	
		38008	TENSOR	
V6. 3.0 L	2006	38279	TENSOR	
		38006	TENSOR	
		38008	TENSOR	
		38279	TENSOR	

## MOUNTAINEER

V6. 4.0 L	2005	38001	POLEA	
		38137	TENSOR PARA BANDA MICRO-V	
V8. 4.6 L	2005	38001	POLEA	LISO
		38006	POLEA	
		38274	TENSOR PARA BANDA MICRO-V	
V6. 4.0 L	2004	38001	POLEA	
		38137	TENSOR PARA BANDA MICRO-V	
V8. 4.6 L	2004	38001	POLEA	LISO
		38006	POLEA	
		38274	TENSOR PARA BANDA MICRO-V	
V6. 4.0 L	2003	38008	POLEA	
		38001	POLEA	
V8. 4.6 L	2003	38137	TENSOR PARA BANDA MICRO-V	
		38006	POLEA	
		38001	POLEA	
V6. 4.0 L	2002	38274	TENSOR PARA BANDA MICRO-V	
		38001	POLEA	
		38008	POLEA	
V8. 4.6 L	2002	38137	TENSOR PARA BANDA MICRO-V	
		38274	TENSOR PARA BANDA MICRO-V	
V6. 4.0 L	2001	38008	POLEA	
		38001	POLEA	
V8. 5.0 L	2001	38137	TENSOR PARA BANDA MICRO-V	A.A. SOPORTE
		38001	POLEA	
		38002	POLEA	
		38006	POLEA	ALT. SOPORTE
V6. 4.0 L	2000	38001	POLEA	
		38008	POLEA	
		38137	TENSOR PARA BANDA MICRO-V	
V8. 5.0 L	2000	38006	POLEA	ALT. SOPORTE
		38002	POLEA	
		38001	POLEA	A.A. SOPORTE
		38161	TENSOR PARA BANDA MICRO-V	
V6. 4.0 L	1999	38008	POLEA	
		38001	POLEA	
		38102	TENSOR PARA BANDA MICRO-V	
V8. 5.0 L	1999	38001	POLEA	A.A. SOPORTE
		38006	POLEA	ALT. SOPORTE
		38002	POLEA	
		38161	TENSOR PARA BANDA MICRO-V	
V6. 4.0 L	1998	38008	POLEA	
		38001	POLEA	
		38102	TENSOR PARA BANDA MICRO-V	
V8. 5.0 L	1998	38002	POLEA	ALT. SOPORTE
		38006	POLEA	A.A. SOPORTE
		38001	POLEA	
		38161	TENSOR PARA BANDA MICRO-V	
V8. 5.0 L	1997	38001	POLEA	
		38002	POLEA	
		38161	TENSOR PARA BANDA MICRO-V	

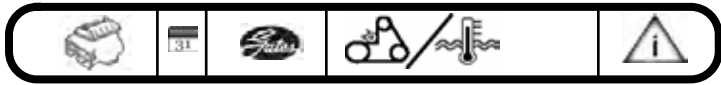

**MYSTIQUE**

4 CIL. 2.0 L	2000	TCK294A	KIT DE DISTRIBUCION	
		TCK294	KIT DE DISTRIBUCION	
		38188	SENSOR	
		38018	SENSOR	
		38008	SENSOR	
		T42034	SENSOR- POLEA DE DIST.	INF.
		T43003	SENSOR- POLEA DE DIST.	
		T42036	SENSOR- POLEA DE DIST.	SUP.
V6, 2.5 L	2000	38006	SENSOR	
		38250	SENSOR	
		38001	SENSOR	
4 CIL. 2.0 L	1999	TCK294A	KIT DE DISTRIBUCION	
		TCK294	KIT DE DISTRIBUCION	
		38188	SENSOR	
		38018	SENSOR	
		T42035	SENSOR- POLEA DE DIST.	SUP.
		T43003	SENSOR- POLEA DE DIST.	
		T42036	SENSOR- POLEA DE DIST.	SUP.
		T42034	SENSOR- POLEA DE DIST.	INF.
V6, 2.5 L	1999	38250	SENSOR	
		38001	SENSOR	
		38006	SENSOR	
4 CIL. 2.0 L	1998	TCK294	KIT DE DISTRIBUCION	
		38008	SENSOR	
		38006	SENSOR	
		38188	SENSOR	
		38018	SENSOR	
		T42035	SENSOR- POLEA DE DIST.	SUP.
		T43003	SENSOR- POLEA DE DIST.	
		T42034	SENSOR- POLEA DE DIST.	INF.
V6, 2.5 L	1998	38250	SENSOR	SERPENTIN
		38001	SENSOR	
		38006	SENSOR	
4 CIL. 2.0 L	1997	TCK258	KIT DE DISTRIBUCION	
		38001	SENSOR	
		38160	SENSOR	
		T42033	SENSOR- POLEA DE DIST.	MANO DERECHA
		T42032	SENSOR- POLEA DE DIST.	MANO IZO.
		T41008	SENSOR- POLEA DE DIST.	
V6, 2.5 L	1997	38250	SENSOR	SERPENTIN
		38001	SENSOR	
		38006	SENSOR	
4 CIL. 2.0 L	1996	TCK258	KIT DE DISTRIBUCION	
		38001	SENSOR	
		38160	SENSOR	
		T42032	SENSOR- POLEA DE DIST.	MANO IZO.
		T41008	SENSOR- POLEA DE DIST.	
		T42033	SENSOR- POLEA DE DIST.	MANO DERECHA
V6, 2.5 L	1996	38001	SENSOR	SERPENTIN
		38250	SENSOR	
		38006	SENSOR	
4 CIL. 2.0 L	1995	TCK258	KIT DE DISTRIBUCION	
		38001	SENSOR	
		38160	SENSOR	
		T41008	SENSOR- POLEA DE DIST.	MANO IZO.
		T42032	SENSOR- POLEA DE DIST.	MANO DERECHA
		T42033	SENSOR- POLEA DE DIST.	
V6, 2.5 L	1995	38001	SENSOR	SERPENTIN
		38250	SENSOR	
		38006	SENSOR	

**SABLE / TAURUS**

V6, 3.0 L	2005	38186	SENSOR	C/MOTOR DE 24 VALVULAS
		38114	SENSOR	C/MOTOR DE 12 VALVULAS
		38006	SENSOR	
V6, 3.0 L	2004	38186	SENSOR	C/MOTOR DE 24 VALVULAS
		38006	SENSOR	ACCESORIOS
		38114	SENSOR	C/MOTOR DE 12 VALVULAS
		38001	SENSOR	C/MOTOR DE 12 VALVULAS
V6, 3.0 L	2003	38001	SENSOR	C/MOTOR DE 12 VALVULAS
		38006	SENSOR	ACCESORIOS
		38114	SENSOR	C/MOTOR DE 12 VALVULAS
		38186	SENSOR	C/MOTOR DE 24 VALVULAS
V6, 3.0 L	2002	38006	SENSOR	S/motor HV
		38114	SENSOR	S/motor HV
		38001	SENSOR	S/motor HV
V6, 3.0 L	2001	38114	SENSOR	
		38001	SENSOR	
		38006	SENSOR	
V6, 3.0 L	2000	38114	SENSOR	
		38001	SENSOR	
		38181	SENSOR	VIN U
		38006	SENSOR	
V6, 3.0 L	1999	38006	SENSOR	
		38114	SENSOR	OHV
		38001	SENSOR	
V6, 3.0 L	1998	38006	SENSOR	DOHC
		38181	SENSOR	
		38001	SENSOR	
V6, 3.0 L	1997	38114	SENSOR	
		38006	SENSOR	
		38001	SENSOR	
V6, 3.0 L	1996	38006	SENSOR	
		38114	SENSOR	
V6, 3.8 L	1995	38009	SENSOR	
		38023	SENSOR	
		38139	SENSOR	
V6, 3.8 L	1994	38139	SENSOR	
		38009	SENSOR	
		38006	SENSOR	
V6, 3.8 L	1993	38009	SENSOR	
		38139	SENSOR	
		38006	SENSOR	

**TRACER**

4 CIL. 2.0 L	1999	TCKWP283A	KIT DE DISTRIBUCION CON B.A.
4 CIL. 2.0 L	1998	TCKWP283A	KIT DE DISTRIBUCION CON B.A.
4 CIL. 2.0 L	1997	TCKWP283A	KIT DE DISTRIBUCION CON B.A.
4 CIL. 1.9 L	1996	TCKWP194	KIT DE DISTRIBUCION CON B.A.
4 CIL. 1.9 L	1995	TCKWP194	KIT DE DISTRIBUCION CON B.A.
4 CIL. 1.9 L	1994	TCKWP194	KIT DE DISTRIBUCION CON B.A.
4 CIL. 1.9 L	1993	TCKWP194	KIT DE DISTRIBUCION CON B.A.
4 CIL. 1.9 L	1992	TCKWP194	KIT DE DISTRIBUCION CON B.A.
4 CIL. 1.9 L	1991	T41006	SENSOR- POLEA DE DIST.
4 CIL. 1.9 L	1991	TCKWP194	KIT DE DISTRIBUCION CON B.A.
4 CIL. 1.6 L (Canada)	1990	T41030	SENSOR- POLEA DE DIST.
4 CIL. 1.6 L	1989	T41030	SENSOR- POLEA DE DIST.
4 CIL. 1.6 L	1988	T41030	SENSOR- POLEA DE DIST.
4 CIL. 1.6 L (Canada)	1987	T41030	SENSOR- POLEA DE DIST.

**SABLE**

V6, 3.0 L	1992	38125	TENSOR PARA BANDA MICRO-V
V6, 3.0 L	1991	38125	TENSOR PARA BANDA MICRO-V
V6, 3.0 L	1990	38125	TENSOR PARA BANDA MICRO-V
V6, 3.0 L	1989	38125	TENSOR PARA BANDA MICRO-V
V6, 3.0 L	1988	38125	TENSOR PARA BANDA MICRO-V

**MINI**

**COOPER**

4 CIL. 1.6 L	2008	36168	POLEA	CON SUPERCARGADO
		38404	TENSOR	
4 CIL. 1.6 L	2007	36168	POLEA	CON SUPERCARGADO
		38404	TENSOR	

4 CIL. 1.6 L	2007	38405	TENSOR	SIN SUPERCARGADO
4 CIL. 1.6 L	2006	36168	POLEA	
		38405	TENSOR	SIN SUPERCARGADO
		38404	TENSOR	CON SUPERCARGADO
4 CIL. 1.6 L	2005	36168	POLEA	
		38405	TENSOR	SIN SUPERCARGADO
		38404	TENSOR	CON SUPERCARGADO

4 CIL. 2.0 L	1994	T41056	TENSOR- POLEA DE DIST.	
		T41056	TENSOR- POLEA DE DIST.	POLEA
		T41046	TENSOR- POLEA DE DIST.	BALANCIN
		T41047	TENSOR- POLEA DE DIST.	BALANCIN
		T41047	TENSOR- POLEA DE DIST.	(DEL TENSOR)
4 CIL. 1.8 L	1993	T41046	TENSOR- POLEA DE DIST.	
		T41056	TENSOR- POLEA DE DIST.	BALANCIN
		T41056	TENSOR- POLEA DE DIST.	BALANCIN
		T41057	TENSOR- POLEA DE DIST.	POLEA
4 CIL. 2.0 L	1993	T41046	TENSOR- POLEA DE DIST.	BALANCIN
		T41047	TENSOR- POLEA DE DIST.	BALANCIN
		T41047	TENSOR- POLEA DE DIST.	BALANCIN
		T41046	TENSOR- POLEA DE DIST.	(DEL TENSOR)
4 CIL. 1.8 L	1992	T41057	TENSOR- POLEA DE DIST.	BALANCIN
		T41057	TENSOR- POLEA DE DIST.	BALANCIN
		T41056	TENSOR- POLEA DE DIST.	BALANCIN
4 CIL. 2.0 L	1992	T41056	TENSOR- POLEA DE DIST.	(DEL TENSOR)
		T41046	TENSOR- POLEA DE DIST.	BALANCIN
		T41047	TENSOR- POLEA DE DIST.	BALANCIN
4 CIL. 1.8 L	1991	T41056	TENSOR- POLEA DE DIST.	BALANCIN
		T41057	TENSOR- POLEA DE DIST.	BALANCIN
4 CIL. 2.0 L	1991	T41046	TENSOR- POLEA DE DIST.	(DEL TENSOR)
		T41047	TENSOR- POLEA DE DIST.	BALANCIN
4 CIL. 1.8 L	1990	T41057	TENSOR- POLEA DE DIST.	BALANCIN
		T41056	TENSOR- POLEA DE DIST.	BALANCIN
4 CIL. 2.0 L	1990	T41046	TENSOR- POLEA DE DIST.	(DEL TENSOR)
		T41047	TENSOR- POLEA DE DIST.	BALANCIN

## MITSUBISHI

### 3000GT

V6. 3.0 L	1999	TCKWP195	KIT DE DISTRIBUCION CON B.A.
		T41048	TENSOR- POLEA DE DIST.
V6. 3.0 L	1998	TCKWP195	KIT DE DISTRIBUCION CON B.A.
		T41048	TENSOR- POLEA DE DIST.
V6. 3.0 L	1997	TCKWP195	KIT DE DISTRIBUCION CON B.A.
		T41048	TENSOR- POLEA DE DIST.
V6. 3.0 L	1996	TCKWP195	KIT DE DISTRIBUCION CON B.A.
V6. 3.0 L	1995	TCKWP195	KIT DE DISTRIBUCION CON B.A.
V6. 3.0 L	1994	TCKWP195	KIT DE DISTRIBUCION CON B.A.
V6. 3.0 L	1993	TCKWP195	KIT DE DISTRIBUCION CON B.A.
V6. 3.0 L	1992	TCKWP195	KIT DE DISTRIBUCION CON B.A.
V6. 3.0 L	1991	TCKWP195	KIT DE DISTRIBUCION CON B.A.

### DIAMANTE

V6. 3.5 L	2004	TCKWP287	KIT DE DISTRIBUCION CON B.A.
V6. 3.5 L	2003	TCKWP287	KIT DE DISTRIBUCION CON B.A.
V6. 3.5 L	2002	TCKWP287	KIT DE DISTRIBUCION CON B.A.
V6. 3.5 L	2001	TCKWP287	KIT DE DISTRIBUCION CON B.A.
V6. 3.5 L	2000	TCKWP287	KIT DE DISTRIBUCION CON B.A.
V6. 3.0 L	1995	TCKWP195	KIT DE DISTRIBUCION CON B.A.
V6. 3.0 L	1994	TCKWP195	KIT DE DISTRIBUCION CON B.A.
V6. 3.0 L	1993	TCKWP195	KIT DE DISTRIBUCION CON B.A.
V6. 3.0 L	1992	TCKWP195	KIT DE DISTRIBUCION CON B.A.

### ECLIPSE

4 CIL. 2.4 L	2008	T43130	TENSOR- POLEA DE DIST.	HIDRAULICO
V6. 3.8 L	2008	TCK287	KIT DE DISTRIBUCION	
		36271	POLEA	
		T41039	TENSOR- POLEA DE DIST.	
		T42018	TENSOR- POLEA DE DIST.	
		T43190	TENSOR- POLEA DE DIST.	
4 CIL. 2.4 L	2007	T43130	TENSOR- POLEA DE DIST.	HIDRAULICO
V6. 3.8 L	2007	TCK287	KIT DE DISTRIBUCION	
		36271	POLEA	
		T41039	TENSOR- POLEA DE DIST.	
		T42018	TENSOR- POLEA DE DIST.	
		T43190	TENSOR- POLEA DE DIST.	
4 CIL. 2.4 L	2006	T43130	TENSOR- POLEA DE DIST.	HIDRAULICO
4 CIL. 2.4 L	2005	T43130	TENSOR- POLEA DE DIST.	HIDRAULICO
V6. 3.0 L	2005	TCK259	KIT DE DISTRIBUCION	
		TCKWP259	KIT DE DISTRIBUCION CON B.A.	
		T41039	TENSOR- POLEA DE DIST.	
		T42018	TENSOR- POLEA DE DIST.	
V6. 3.0 L	2004	TCK259	KIT DE DISTRIBUCION	
		TCKWP259	KIT DE DISTRIBUCION CON B.A.	
		T42018	TENSOR- POLEA DE DIST.	
		T41039	TENSOR- POLEA DE DIST.	
V6. 3.0 L	2003	TCKWP259	KIT DE DISTRIBUCION CON B.A.	
V6. 3.0 L	2002	TCKWP259	KIT DE DISTRIBUCION CON B.A.	
V6. 3.0 L	2001	TCKWP259	KIT DE DISTRIBUCION CON B.A.	
4 CIL. 2.0 L	1999	TCKWP246	KIT DE DISTRIBUCION CON B.A.	
4 CIL. 2.0 L	1998	TCKWP246	KIT DE DISTRIBUCION CON B.A.	
4 CIL. 2.0 L	1997	TCKWP246	KIT DE DISTRIBUCION CON B.A.	
4 CIL. 2.0 L	1996	TCKWP246	KIT DE DISTRIBUCION CON B.A.	
4 CIL. 2.0 L	1995	TCKWP246	KIT DE DISTRIBUCION CON B.A.	
4 CIL. 1.8 L	1994	T41057	TENSOR- POLEA DE DIST.	BALANCIN
		T41057	TENSOR- POLEA DE DIST.	BALANCIN

### ENDEAVOR

V6. 3.8 L	2007	TCK287	KIT DE DISTRIBUCION
		T42018	TENSOR- POLEA DE DIST.
		T41039	TENSOR- POLEA DE DIST.
V6. 3.8 L	2006	TCK287	KIT DE DISTRIBUCION
		T42018	TENSOR- POLEA DE DIST.
		T41039	TENSOR- POLEA DE DIST.
V6. 3.5 L	2005	TCKWP287	KIT DE DISTRIBUCION CON B.A.
V6. 3.8 L	2005	TCK287	KIT DE DISTRIBUCION
		T41039	TENSOR- POLEA DE DIST.
		T42018	TENSOR- POLEA DE DIST.
V6. 3.5 L	2004	TCKWP287	KIT DE DISTRIBUCION CON B.A.
V6. 3.8 L	2004	TCK287	KIT DE DISTRIBUCION
		T41039	TENSOR- POLEA DE DIST.
		T42018	TENSOR- POLEA DE DIST.

### GALANT

4 CIL. 2.4 L	2008	T43130	TENSOR- POLEA DE DIST.	HIDRAULICO
4 CIL. 2.4 L	2007	T41038	TENSOR- POLEA DE DIST.	BANDA DISTRIBUIDOR
		T43130	TENSOR- POLEA DE DIST.	HIDRAULICO
V6. 3.8 L	2007	TCK287	KIT DE DISTRIBUCION	
4 CIL. 2.4 L	2006	T41038	TENSOR- POLEA DE DIST.	BANDA BALANCIN
		T43130	TENSOR- POLEA DE DIST.	HIDRAULICO
V6. 3.8 L	2006	TCK287	KIT DE DISTRIBUCION	
4 CIL. 2.4 L	2005	T43130	TENSOR- POLEA DE DIST.	HIDRAULICO
		T41038	TENSOR- POLEA DE DIST.	
V6. 3.0 L	2005	TCKWP259	KIT DE DISTRIBUCION CON B.A.	
V6. 3.8 L	2005	TCK287	KIT DE DISTRIBUCION	
		T42018	TENSOR- POLEA DE DIST.	
		T41039	TENSOR- POLEA DE DIST.	
4 CIL. 2.4 L	2004	T43130	TENSOR- POLEA DE DIST.	HIDRAULICO
		T41038	TENSOR- POLEA DE DIST.	
V6. 3.0 L	2004	TCKWP259	KIT DE DISTRIBUCION CON B.A.	
V6. 3.8 L	2004	TCK287	KIT DE DISTRIBUCION	
		T41039	TENSOR- POLEA DE DIST.	
		T42018	TENSOR- POLEA DE DIST.	
V6. 3.0 L	2003	TCKWP259	KIT DE DISTRIBUCION CON B.A.	
V6. 3.0 L	2002	TCKWP259	KIT DE DISTRIBUCION CON B.A.	
V6. 3.0 L	2001	TCKWP259	KIT DE DISTRIBUCION CON B.A.	
4 CIL. 2.4 L	1995	T41047	TENSOR- POLEA DE DIST.	BALANCIN

4 CIL. 2.4 L	1995	T41047	SENSOR- POLEA DE DIST.	BALANCIN
4 CIL. 2.4 L	1994	T41047	SENSOR- POLEA DE DIST.	BALANCIN
		T41047	SENSOR- POLEA DE DIST.	BALANCIN
4 CIL. 2.0 L	1993	T41047	SENSOR- POLEA DE DIST.	BALANCIN
		T41047	SENSOR- POLEA DE DIST.	BALANCIN
4 CIL. 2.0 L	1992	T41053	SENSOR- POLEA DE DIST.	BALANCIN
		T41047	SENSOR- POLEA DE DIST.	BALANCIN
		T41043	SENSOR- POLEA DE DIST.	
		T41043	SENSOR- POLEA DE DIST.	
		T41046	SENSOR- POLEA DE DIST.	POLEA
		T41047	SENSOR- POLEA DE DIST.	BALANCIN
		T41046	SENSOR- POLEA DE DIST.	(DEL TENSOR)
		T41053	SENSOR- POLEA DE DIST.	BALANCIN
4 CIL. 2.0 L	1991	T41047	SENSOR- POLEA DE DIST.	BALANCIN
		T41053	SENSOR- POLEA DE DIST.	BALANCIN
		T41043	SENSOR- POLEA DE DIST.	
		T41046	SENSOR- POLEA DE DIST.	(DEL TENSOR)
4 CIL. 2.0 L	1990	T41047	SENSOR- POLEA DE DIST.	BALANCIN
		T41053	SENSOR- POLEA DE DIST.	BALANCIN
		T41046	SENSOR- POLEA DE DIST.	(DEL TENSOR)
		T41043	SENSOR- POLEA DE DIST.	
4 CIL. 2.0 L	1989	T41047	SENSOR- POLEA DE DIST.	BALANCIN
		T41053	SENSOR- POLEA DE DIST.	BALANCIN
		T41043	SENSOR- POLEA DE DIST.	
		T41046	SENSOR- POLEA DE DIST.	
4 CIL. 2.4 L	1987	T41053	SENSOR- POLEA DE DIST.	BALANCIN
		T41043	SENSOR- POLEA DE DIST.	
4 CIL. 2.4 L	1986	T41053	SENSOR- POLEA DE DIST.	BALANCIN
		T41043	SENSOR- POLEA DE DIST.	
4 CIL. 2.4 L	1985	T41053	SENSOR- POLEA DE DIST.	BALANCIN
		T41043	SENSOR- POLEA DE DIST.	

4 CIL. 1.8 L		T41052	SENSOR- POLEA DE DIST.	
4 CIL. 1.5 L	1992	T41051	SENSOR- POLEA DE DIST.	
4 CIL. 1.6 L	1992	T41046	SENSOR- POLEA DE DIST.	(DEL TENSOR)
4 CIL. 1.5 L	1991	T41051	SENSOR- POLEA DE DIST.	
4 CIL. 1.6 L	1991	T41046	SENSOR- POLEA DE DIST.	(DEL TENSOR)
4 CIL. 1.5 L	1990	T41042	SENSOR- POLEA DE DIST.	
4 CIL. 1.5 L	1989	T41042	SENSOR- POLEA DE DIST.	
4 CIL. 1.6 L	1989	T41046	SENSOR- POLEA DE DIST.	(DEL TENSOR)
4 CIL. 1.5 L	1988	T41042	SENSOR- POLEA DE DIST.	
4 CIL. 1.6 L	1988	T41056	SENSOR- POLEA DE DIST.	
4 CIL. 1.5 L	1987	T41042	SENSOR- POLEA DE DIST.	
4 CIL. 1.6 L	1987	T41055	SENSOR- POLEA DE DIST.	
		T41056	SENSOR- POLEA DE DIST.	
4 CIL. 1.6 L	1986	T41055	SENSOR- POLEA DE DIST.	
4 CIL. 1.6 L	1985	T41055	SENSOR- POLEA DE DIST.	

**GRANDIS**

4 CIL. 2.4 L	2008	38413	TENSOR
4 CIL. 2.4 L	2007	38413	TENSOR

**LANCER**

4 CIL. 2.0 L	2008	TCK201	KIT DE DISTRIBUCION	
		T41212	SENSOR- POLEA DE DIST.	
4 CIL. 2.0 L	2007	TCK201	KIT DE DISTRIBUCION	
		T41212	SENSOR- POLEA DE DIST.	
4 CIL. 2.0 L	2006	T41038	SENSOR- POLEA DE DIST.	BALANCIN
		T43130	SENSOR- POLEA DE DIST.	HIDRAULICO
4 CIL. 2.4 L	2006	T43130	SENSOR- POLEA DE DIST.	HIDRAULICO
4 CIL. 2.0 L	2005	T41212	SENSOR- POLEA DE DIST.	
		T41038	SENSOR- POLEA DE DIST.	
		T42017	SENSOR- POLEA DE DIST.	
		T41212	SENSOR- POLEA DE DIST.	
		T43130	SENSOR- POLEA DE DIST.	HIDRAULICO
4 CIL. 2.4 L	2005	T43130	SENSOR- POLEA DE DIST.	HIDRAULICO
		T41038	SENSOR- POLEA DE DIST.	
4 CIL. 2.0 L	2004	T41212	SENSOR- POLEA DE DIST.	
		T41038	SENSOR- POLEA DE DIST.	
		T42017	SENSOR- POLEA DE DIST.	
		T43130	SENSOR- POLEA DE DIST.	HIDRAULICO
4 CIL. 2.4 L	2004	T41038	SENSOR- POLEA DE DIST.	
		T43130	SENSOR- POLEA DE DIST.	HIDRAULICO
4 CIL. 2.0 L	2003	T43130	SENSOR- POLEA DE DIST.	HIDRAULICO

**MIRAGE**

4 CIL. 1.5 L	1999	T41211	SENSOR- POLEA DE DIST.	
4 CIL. 1.5 L	1998	T41211	SENSOR- POLEA DE DIST.	
4 CIL. 1.5 L	1997	T41211	SENSOR- POLEA DE DIST.	
4 CIL. 1.5 L	1996	T41051	SENSOR- POLEA DE DIST.	
4 CIL. 1.8 L	1996	T41052	SENSOR- POLEA DE DIST.	
4 CIL. 1.5 L	1995	T41051	SENSOR- POLEA DE DIST.	
4 CIL. 1.8 L	1995	T41052	SENSOR- POLEA DE DIST.	
4 CIL. 1.5 L	1994	T41051	SENSOR- POLEA DE DIST.	
4 CIL. 1.8 L	1994	T41052	SENSOR- POLEA DE DIST.	
4 CIL. 1.5 L	1993	T41051	SENSOR- POLEA DE DIST.	

**MONTERO**

V6. 3.8 L	2007	T42018	TENSOR- POLEA DE DIST.	
		T41039	TENSOR- POLEA DE DIST.	
V6. 3.8 L	2006	T42018	TENSOR- POLEA DE DIST.	
		T41039	TENSOR- POLEA DE DIST.	
V6. 3.8 L	2005	T42018	TENSOR- POLEA DE DIST.	
		T41039	TENSOR- POLEA DE DIST.	
V6. 3.8 L	2004	T41039	TENSOR- POLEA DE DIST.	
		T42018	TENSOR- POLEA DE DIST.	
V6. 3.0 L	1994	T41048	TENSOR- POLEA DE DIST.	
V6. 3.0 L	1993	T41048	TENSOR- POLEA DE DIST.	
V6. 3.0 L	1992	T41048	TENSOR- POLEA DE DIST.	

**MONTERO SPORT**

V6. 3.5 L	2004	TCK287	KIT DE DISTRIBUCION	
		T41039	TENSOR- POLEA DE DIST.	
		T42018	TENSOR- POLEA DE DIST.	
V6. 2.5 L	2000	TCKWP259A	KIT DE DISTRIBUCION CON B.A.	
V6. 2.5 L	1999	TCKWP259A	KIT DE DISTRIBUCION CON B.A.	
V6. 2.5 L	1998	TCKWP259A	KIT DE DISTRIBUCION CON B.A.	
V6. 2.5 L	1997	TCKWP259A	KIT DE DISTRIBUCION CON B.A.	
V6. 2.5 L	1996	TCKWP259A	KIT DE DISTRIBUCION CON B.A.	
V6. 2.5 L	1995	TCKWP259A	KIT DE DISTRIBUCION CON B.A.	

**OUTLANDER**

V6. 3.0 L	2008	T43189	TENSOR- POLEA DE DIST.	
V6. 3.0 L	2007	T43189	TENSOR- POLEA DE DIST.	
4 CIL. 2.4 L	2006	T41038	TENSOR- POLEA DE DIST.	BALANCIN
		T43130	TENSOR- POLEA DE DIST.	HIDRAULICO
4 CIL. 2.4 L	2005	T41038	TENSOR- POLEA DE DIST.	BALANCIN
		T43130	TENSOR- POLEA DE DIST.	HIDRAULICO
4 CIL. 2.4 L	2004	T43130	TENSOR- POLEA DE DIST.	HIDRAULICO
		T41038	TENSOR- POLEA DE DIST.	

**PICKUP**

4 CIL. 2.4 L	1996	T41047	TENSOR- POLEA DE DIST.	BALANCIN
		T41043	TENSOR- POLEA DE DIST.	
		T41043	TENSOR- POLEA DE DIST.	
		T41047	TENSOR- POLEA DE DIST.	BALANCIN
4 CIL. 2.4 L	1995	T41043	TENSOR- POLEA DE DIST.	BALANCIN
		T41043	TENSOR- POLEA DE DIST.	
		T41047	TENSOR- POLEA DE DIST.	BALANCIN
		T41047	TENSOR- POLEA DE DIST.	BALANCIN
4 CIL. 2.4 L	1994	T41047	TENSOR- POLEA DE DIST.	BALANCIN
		T41043	TENSOR- POLEA DE DIST.	
		T41043	TENSOR- POLEA DE DIST.	
V6. 3.0 L	1994	T41048	TENSOR- POLEA DE DIST.	BALANCIN
4 CIL. 2.4 L	1993	T41043	TENSOR- POLEA DE DIST.	
		T41047	TENSOR- POLEA DE DIST.	BALANCIN
		T41043	TENSOR- POLEA DE DIST.	
		T41047	TENSOR- POLEA DE DIST.	BALANCIN
V6. 3.0 L	1993	T41048	TENSOR- POLEA DE DIST.	BALANCIN
4 CIL. 2.4 L	1992	T41043	TENSOR- POLEA DE DIST.	

4 CIL. 2.4 L	1992	T41045	TENSOR- POLEA DE DIST.	BALANCIN
		T41043	TENSOR- POLEA DE DIST.	
		T41045	TENSOR- POLEA DE DIST.	BALANCIN
V6, 3.0 L	1992	T41048	TENSOR- POLEA DE DIST.	
4 CIL. 2.4 L	1991	T41043	TENSOR- POLEA DE DIST.	
		T41045	TENSOR- POLEA DE DIST.	BALANCIN
4 CIL. 2.4 L	1990	T41043	TENSOR- POLEA DE DIST.	
		T41045	TENSOR- POLEA DE DIST.	BALANCIN
4 CIL. 2.0 L	1989	T41045	TENSOR- POLEA DE DIST.	BALANCIN
4 CIL. 2.0 L	1988	T41045	TENSOR- POLEA DE DIST.	BALANCIN
		T41043	TENSOR- POLEA DE DIST.	
4 CIL. 2.0 L	1987	T41043	TENSOR- POLEA DE DIST.	
		T41053	TENSOR- POLEA DE DIST.	BALANCIN
		T41045	TENSOR- POLEA DE DIST.	BALANCIN
4 CIL. 2.3 L Diesel	1985	T41050	TENSOR- POLEA DE DIST.	
		T41049	TENSOR- POLEA DE DIST.	BALANCIN
4 CIL. 2.3 L Diesel	1984	T41049	TENSOR- POLEA DE DIST.	BALANCIN
		T41050	TENSOR- POLEA DE DIST.	
4 CIL. 2.3 L Diesel	1983	T41049	TENSOR- POLEA DE DIST.	BALANCIN
		T41050	TENSOR- POLEA DE DIST.	

		T42021	TENSOR- POLEA DE DIST.	INF.
		T42020	TENSOR- POLEA DE DIST.	SUP.

**PRECIS**

4 CIL. 1.5 L	1994	T41042	TENSOR- POLEA DE DIST.	
4 CIL. 1.5 L	1993	T41042	TENSOR- POLEA DE DIST.	
4 CIL. 1.5 L	1992	T41042	TENSOR- POLEA DE DIST.	
4 CIL. 1.5 L	1991	T41042	TENSOR- POLEA DE DIST.	
4 CIL. 1.5 L	1990	T41042	TENSOR- POLEA DE DIST.	

**VAN**

4 CIL. 2.4 L	1990	T41045	TENSOR- POLEA DE DIST.	BALANCIN
		T41043	TENSOR- POLEA DE DIST.	
4 CIL. 2.4 L	1989	T41043	TENSOR- POLEA DE DIST.	
		T41045	TENSOR- POLEA DE DIST.	BALANCIN
4 CIL. 2.4 L	1988	T41045	TENSOR- POLEA DE DIST.	BALANCIN
		T41043	TENSOR- POLEA DE DIST.	
4 CIL. 2.4 L	1987	T41053	TENSOR- POLEA DE DIST.	BALANCIN
		T41045	TENSOR- POLEA DE DIST.	BALANCIN
		T41043	TENSOR- POLEA DE DIST.	

**NISSAN**

**200SX**

4 CIL. 2.0 L	1988	T41088	TENSOR- POLEA DE DIST.	
4 CIL. 1.8 L (Canada)	1987	T41088	TENSOR- POLEA DE DIST.	
4 CIL. 2.0 L	1987	T41089	TENSOR- POLEA DE DIST.	
4 CIL. 1.8 L	1986	T41088	TENSOR- POLEA DE DIST.	
4 CIL. 2.0 L	1986	T41089	TENSOR- POLEA DE DIST.	
4 CIL. 1.8 L	1985	T41088	TENSOR- POLEA DE DIST.	
4 CIL. 2.0 L	1985	T41089	TENSOR- POLEA DE DIST.	
4 CIL. 1.8 L	1984	T41088	TENSOR- POLEA DE DIST.	
4 CIL. 2.0 L	1984	T41089	TENSOR- POLEA DE DIST.	

**300ZX**

V6, 3.0 L	1996	T42021	TENSOR- POLEA DE DIST.	INF.
		T41085	TENSOR- POLEA DE DIST.	
		T41085	TENSOR- POLEA DE DIST.	
		T42020	TENSOR- POLEA DE DIST.	SUP.
		T42020	TENSOR- POLEA DE DIST.	SUP.
		T42021	TENSOR- POLEA DE DIST.	INF.
V6, 3.0 L	1995	T41085	TENSOR- POLEA DE DIST.	
		T42020	TENSOR- POLEA DE DIST.	SUP.
		T42021	TENSOR- POLEA DE DIST.	INF.
V6, 3.0 L	1994	T41085	TENSOR- POLEA DE DIST.	
		T42020	TENSOR- POLEA DE DIST.	SUP.
		T42021	TENSOR- POLEA DE DIST.	INF.
V6, 3.0 L	1993	T41085	TENSOR- POLEA DE DIST.	

**350Z**

V6, 3.5 L	2009	36306	POLEA	LISA
		36305	POLEA	RANURADA
V6, 3.5 L	2008	36306	POLEA	LISA
		36305	POLEA	RANURADA
V6, 3.5 L	2007	36305	POLEA	RANURADA
		36306	POLEA	LISA

**370Z**

V6, 3.7 L	2009	36305	POLEA	
-----------	------	-------	-------	--

**ALTIMA**

4 CIL. 2.5 L	2006	38284	TENSOR	
V6, 3.5 L	2006	36087	POLEA	
		36087	POLEA	
4 CIL. 2.5 L	2005	38284	TENSOR	
V6, 3.5 L	2005	36087	POLEA	
4 CIL. 2.4 L	2004	38284	TENSOR	
		38284	TENSOR PARA BANDA MICRO-V	
4 CIL. 2.5 L	2004	38284	TENSOR	
V6, 3.5 L	2004	36087	POLEA	
4 CIL. 2.5 L	2003	38284	TENSOR	
V6, 3.5 L	2003	36087	POLEA	ALT. Y A.A.
V6, 3.5 L	2002	36087	POLEA	ALT. Y A.A.
4 CIL. 2.4 L	2001	38044	POLEA	A.A.
		38044	TENSOR	A.A.
4 CIL. 2.4 L	2000	38044	TENSOR	A.A.
4 CIL. 2.4 L	1999	38044	TENSOR	A.A.
4 CIL. 2.4 L	1998	38044	TENSOR	A.A.

**APRIO**

4 CIL. 1.6 L	2010	TCK1095M	KIT DE DISTRIBUCION	
		T38484	TENSOR- POLEA DE DIST.	SIN A.A.
		T38456	TENSOR- POLEA DE DIST.	CON A.A.
		T41237	TENSOR- POLEA DE DIST.	
		T43064	TENSOR- POLEA DE DIST.	
4 CIL. 1.6 L	2010	TCK1095M	KIT DE DISTRIBUCION	
		TCKWP1095M	KIT DE DISTRIBUCION CON B.A.	
4 CIL. 1.6 L	2009	TCK1095M	KIT DE DISTRIBUCION	
		T43064	TENSOR- POLEA DE DIST.	
		T38484	TENSOR- POLEA DE DIST.	SIN A.A.
		T38456	TENSOR- POLEA DE DIST.	CON A.A.
		T41237	TENSOR- POLEA DE DIST.	
4 CIL. 1.6 L	2009	TCK1095M	KIT DE DISTRIBUCION	
		TCKWP1095M	KIT DE DISTRIBUCION CON B.A.	
4 CIL. 1.6 L	2008	TCK1095M	KIT DE DISTRIBUCION	
		T38484	TENSOR- POLEA DE DIST.	SIN A.A.
		T41237	TENSOR- POLEA DE DIST.	
		T43064	TENSOR- POLEA DE DIST.	
		T43064	TENSOR- POLEA DE DIST.	
		T38456	TENSOR- POLEA DE DIST.	CON A.A.
4 CIL. 1.6 L	2008	TCK1095M	KIT DE DISTRIBUCION	
		TCKWP1095M	KIT DE DISTRIBUCION CON B.A.	

**ARMADA**

V8, 5.6 L	2010	38340	TENSOR	
V8, 5.6 L	2009	36222	POLEA	
		38340	TENSOR	
V8, 5.6 L	2008	36222	POLEA	
		38340	TENSOR	
V8, 5.6 L	2007	36222	POLEA	
		38340	TENSOR	
V8, 5.6 L	2006	36222	POLEA	
		38340	TENSOR	
		38340	TENSOR PARA BANDA MICRO-V	

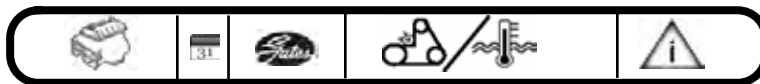
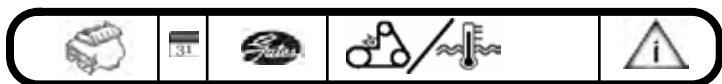

**FRONTIER**

V6, 4.0 L	2008	38378	TENSOR	
		38378	TENSOR PARA BANDA MICRO-V	
V6, 4.0 L	2007	38378	TENSOR	
V6, 4.0 L	2006	38378	TENSOR	
4 CIL. 2.4 L	2004	38037	TENSOR	D.H.
V6, 3.3 L	2004	TCK249	KIT DE DISTRIBUCION	
		T41059	TENSOR- POLEA DE DIST.	
		T41059	TENSOR- POLEA DE DIST.	
4 CIL. 2.4 L	2003	38037	TENSOR	D.H.
V6, 3.3 L	2003	TCK249	KIT DE DISTRIBUCION	
		T41059	TENSOR- POLEA DE DIST.	
4 CIL. 2.4 L	2002	38037	TENSOR	D.H.
V6, 3.3 L	2002	TCK249	KIT DE DISTRIBUCION	
		T41059	TENSOR- POLEA DE DIST.	
4 CIL. 2.4 L	2001	36116	POLEA	A.A.
		36116	POLEA	A.A.
		38037	TENSOR	D.H.
V6, 3.3 L	2001	TCK249	KIT DE DISTRIBUCION	
		38005	TENSOR	VENTILADOR Y D.H.
		T41059	TENSOR- POLEA DE DIST.	
4 CIL. 2.4 L	2000	36116	POLEA	A.A.
		38037	TENSOR	D.H.
V6, 3.3 L	2000	TCK249	KIT DE DISTRIBUCION	
		38005	TENSOR	VENTILADOR Y D.H.
		T41059	TENSOR- POLEA DE DIST.	
4 CIL. 2.4 L	1999	36116	POLEA	A.A.
		38037	TENSOR	D.H.
V6, 3.3 L	1999	TCK249	KIT DE DISTRIBUCION	
		38005	TENSOR	VENTILADOR Y D.H.
		T41059	TENSOR- POLEA DE DIST.	

**MAXIMA**

V6, 3.5 L	2005	36087	POLEA	ALT. Y A.A.
V6, 3.0 L	2004	36115	POLEA	B.A. & D.H. SOHC
		36115	POLEA	B.A. & D.H. SOHC
V6, 3.5 L	2004	36087	POLEA	ALT. & A.A.
V6, 3.5 L	2003	36087	POLEA	ALT. Y A.A.
V6, 3.5 L	2002	36087	POLEA	ALT. Y A.A.
V6, 3.0 L	1994	TCK249	KIT DE DISTRIBUCION	
		TCK104	KIT DE DISTRIBUCION	
		36115	POLEA	B. AGUA Y D.H.
		T41059	TENSOR- POLEA DE DIST.	
V6, 3.0 L	1993	TCK104	KIT DE DISTRIBUCION	
		TCK249	KIT DE DISTRIBUCION	
		36115	POLEA	B. AGUA Y D.H.
		T41059	TENSOR- POLEA DE DIST.	

**MURANO**

6 CIL. 3.5 L	2006	36087	POLEA	
V6, 3.5 L	2004	36087	POLEA	ALT. Y A.A.
V6, 3.5 L	2003	36087	POLEA	ALT. Y A.A.

**PATHFINDER**

V6, 4.0 L	2010	36222	POLEA	
		38378	TENSOR	
V6, 4.0 L	2009	36222	POLEA	
		38378	TENSOR	
V6, 4.0 L	2008	36222	POLEA	
		38378	TENSOR	
V6, 4.0 L	2007	38378	TENSOR	
V6, 4.0 L	2006	38378	TENSOR	
V6, 4.0 L	2005	38378	TENSOR	
V6, 3.3 L	2000	TCK249	KIT DE DISTRIBUCION	
		T41059	TENSOR- POLEA DE DIST.	
V6, 3.3 L	1999	TCK249	KIT DE DISTRIBUCION	
		T41059	TENSOR- POLEA DE DIST.	
V6, 3.3 L	1998	TCK249	KIT DE DISTRIBUCION	
		T41059	TENSOR- POLEA DE DIST.	

V6, 3.0 L	1997	TCK249	KIT DE DISTRIBUCION	
		T41059	TENSOR- POLEA DE DIST.	
	1995	TCK249	KIT DE DISTRIBUCION	
		36118	POLEA	A.A.
		36118	POLEA	A.A.
		T41059	TENSOR- POLEA DE DIST.	

**PICK-UP**

4 CIL. 2.4 L	1997	38036	POLEA	D.H.
		38036	TENSOR	D.H.
4 CIL. 2.4 L	1996	38036	TENSOR	D.H.
4 CIL. 2.4 L	1995	38036	TENSOR	D.H.
4 CIL. 2.4 L	1994	38036	TENSOR	D.H.
4 CIL. 2.4 L	1993	38036	TENSOR	D.H.

**PLATINA**

4 CIL. 1.6 L	2010	TCK1095M	KIT DE DISTRIBUCION	
		T38456	TENSOR- POLEA DE DIST.	CON A.A.
		T43064	TENSOR- POLEA DE DIST.	
		T41237	TENSOR- POLEA DE DIST.	
		T38484	TENSOR- POLEA DE DIST.	SIN A.A.
4 CIL. 1.6 L	2010	TCK1095M	KIT DE DISTRIBUCION	
		TCKWP1095M	KIT DE DISTRIBUCION CON B.A.	
4 CIL. 1.6 L	2009	TCK1095M	KIT DE DISTRIBUCION	
		T43064	TENSOR- POLEA DE DIST.	
		T38484	TENSOR- POLEA DE DIST.	SIN A.A.
		T41237	TENSOR- POLEA DE DIST.	
		T38456	TENSOR- POLEA DE DIST.	CON A.A.
4 CIL. 1.6 L	2009	TCK1095M	KIT DE DISTRIBUCION	
		TCKWP1095M	KIT DE DISTRIBUCION CON B.A.	
4 CIL. 1.6 L	2008	TCK1095M	KIT DE DISTRIBUCION	
		T41237	TENSOR- POLEA DE DIST.	
		T43064	TENSOR- POLEA DE DIST.	
		T38456	TENSOR- POLEA DE DIST.	CON A.A.
		T38484	TENSOR- POLEA DE DIST.	SIN A.A.
4 CIL. 1.6 L	2008	TCK1095M	KIT DE DISTRIBUCION	
		TCKWP1095M	KIT DE DISTRIBUCION CON B.A.	
4 CIL. 1.6 L	2007	TCK1095M	KIT DE DISTRIBUCION	
		T41237	TENSOR- POLEA DE DIST.	
		T38484	TENSOR- POLEA DE DIST.	SIN A.A.
		T38456	TENSOR- POLEA DE DIST.	CON A.A.
		T43064	TENSOR- POLEA DE DIST.	
4 CIL. 1.6 L	2007	TCK1095M	KIT DE DISTRIBUCION	
		TCKWP1095M	KIT DE DISTRIBUCION CON B.A.	
4 CIL. 1.6 L	2006	TCK1095M	KIT DE DISTRIBUCION	
		T41237	TENSOR- POLEA DE DIST.	
		T38484	TENSOR- POLEA DE DIST.	SIN A.A.
		T38456	TENSOR- POLEA DE DIST.	CON A.A.
		T43064	TENSOR- POLEA DE DIST.	
4 CIL. 1.6 L	2006	TCK1095M	KIT DE DISTRIBUCION	
		TCKWP1095M	KIT DE DISTRIBUCION CON B.A.	
4 CIL. 1.6 L	2005	TCK1095M	KIT DE DISTRIBUCION	
		T41237	TENSOR- POLEA DE DIST.	
		T38456	TENSOR- POLEA DE DIST.	CON A.A.
		T38484	TENSOR- POLEA DE DIST.	SIN A.A.
		T43064	TENSOR- POLEA DE DIST.	
4 CIL. 1.6 L	2005	TCK1095M	KIT DE DISTRIBUCION	
		TCKWP1095M	KIT DE DISTRIBUCION CON B.A.	
4 CIL. 1.6 L	2004	TCK1095M	KIT DE DISTRIBUCION	
		T41237	TENSOR- POLEA DE DIST.	
		T38456	TENSOR- POLEA DE DIST.	CON A.A.
		T43064	TENSOR- POLEA DE DIST.	
		T38484	TENSOR- POLEA DE DIST.	SIN A.A.
4 CIL. 1.6 L	2004	TCK1095M	KIT DE DISTRIBUCION	
		TCKWP1095M	KIT DE DISTRIBUCION CON B.A.	
4 CIL. 1.6 L	2003	TCK1095M	KIT DE DISTRIBUCION	
		T43064	TENSOR- POLEA DE DIST.	
		T41237	TENSOR- POLEA DE DIST.	
		T38456	TENSOR- POLEA DE DIST.	CON A.A.
		T38484	TENSOR- POLEA DE DIST.	SIN A.A.
4 CIL. 1.6 L	2003	TCK1095M	KIT DE DISTRIBUCION	



4 CIL. 1.6 L	2003	TCKWP1095M	KIT DE DISTRIBUCION CON B.A.	
4 CIL. 1.6 L	2002	TCK1095M	KIT DE DISTRIBUCION	
		T41237	SENSOR- POLEA DE DIST.	
		T38456	SENSOR- POLEA DE DIST.	CON A.A.
		T38484	SENSOR- POLEA DE DIST.	SIN A.A.
		T43064	SENSOR- POLEA DE DIST.	
4 CIL. 1.6 L	2002	TCK1095M	KIT DE DISTRIBUCION	
		TCKWP1095M	KIT DE DISTRIBUCION CON B.A.	

**PULSAR NX**

4 CIL. 1.8 L	1989	T41187	SENSOR- POLEA DE DIST.	
4 CIL. 1.8 L	1988	T41187	SENSOR- POLEA DE DIST.	
4 CIL. 1.6 L	1987	T41187	SENSOR- POLEA DE DIST.	

**QUEST**

V6. 3.5 L	2009	36087	POLEA	
V6. 3.5 L	2008	36087	POLEA	
V6. 3.5 L	2007	36087	POLEA	
6 CIL. 3.5 L	2006	36087	POLEA	ALT. & A.A.
6 CIL. 3.3 L	2002	TCK249	KIT DE DISTRIBUCION	
V6. 3.3 L	2001	TCK249	KIT DE DISTRIBUCION	
		T41059	SENSOR- POLEA DE DIST.	
V6. 3.3 L	2000	TCK249	KIT DE DISTRIBUCION	
		38044	SENSOR	A.A.
		T41059	SENSOR- POLEA DE DIST.	
V6. 3.3 L	1999	TCK249	KIT DE DISTRIBUCION	
		38044	SENSOR	A.A.
		T41059	SENSOR- POLEA DE DIST.	
V6. 3.0 L	1998	TCK249	KIT DE DISTRIBUCION	
		38044	SENSOR	A.A.
		T41059	SENSOR- POLEA DE DIST.	
V6. 3.0 L	1997	TCK249	KIT DE DISTRIBUCION	
		38044	SENSOR	A.A.
		T41059	SENSOR- POLEA DE DIST.	

**SENTRA**

4 CIL. 1.8 L	2006	36142	POLEA	ALT. C/AA
		36142	POLEA	ALT. C/AA
4 CIL. 2.5 L	2006	38284	SENSOR	
4 CIL. 2.5 L	2005	38284	SENSOR	
4 CIL. 2.5 L	2004	38284	SENSOR	
4 CIL. 2.5 L	2003	38284	SENSOR	

**STANZA**

4 CIL. 2.0 L	1989	T41088	SENSOR- POLEA DE DIST.	
4 CIL. 2.0 L	1988	T41088	SENSOR- POLEA DE DIST.	
4 CIL. 2.0 L	1987	T41088	SENSOR- POLEA DE DIST.	
4 CIL. 2.0 L	1986	T41088	SENSOR- POLEA DE DIST.	
4 CIL. 2.0 L	1985	T41088	SENSOR- POLEA DE DIST.	
4 CIL. 2.0 L	1984	T41088	SENSOR- POLEA DE DIST.	
4 CIL. 2.0 L	1983	T41088	SENSOR- POLEA DE DIST.	
4 CIL. 2.0 L	1982	T41088	SENSOR- POLEA DE DIST.	

**TITAN**

V8. 5.6 L	2009	36222	POLEA	
		38340	SENSOR	
V8. 5.6 L	2008	38340	SENSOR	
V8. 5.6 L	2007	38340	SENSOR	
V8. 5.6 L	2006	38340	SENSOR	
V8. 5.6 L	2005	38340	SENSOR	
V8. 5.6 L	2004	38340	SENSOR	

**TSURU**

4 CIL. 1.6 L	1997	TCKWP077	KIT DE DISTRIBUCION CON B.A.	
4 CIL. 1.6 L	1996	TCKWP077	KIT DE DISTRIBUCION CON B.A.	
4 CIL. 1.6 L	1995	TCKWP077	KIT DE DISTRIBUCION CON B.A.	
4 CIL. 1.6 L	1994	T41058	SENSOR- POLEA DE DIST.	
4 CIL. 1.6 L	1994	TCKWP077	KIT DE DISTRIBUCION CON B.A.	

4 CIL. 1.6 L	1993	T41058	SENSOR- POLEA DE DIST.	
4 CIL. 1.6 L	1993	TCKWP077	KIT DE DISTRIBUCION CON B.A.	
4 CIL. 1.6 L	1992	T41058	SENSOR- POLEA DE DIST.	
4 CIL. 1.6 L	1992	TCKWP077	KIT DE DISTRIBUCION CON B.A.	
4 CIL. 1.6 L	1991	T41058	SENSOR- POLEA DE DIST.	
4 CIL. 1.6 L	1991	TCKWP077	KIT DE DISTRIBUCION CON B.A.	
4 CIL. 1.6 L	1990	T41058	SENSOR- POLEA DE DIST.	
4 CIL. 1.6 L	1990	TCKWP077	KIT DE DISTRIBUCION CON B.A.	
4 CIL. 1.6 L	1989	T41058	SENSOR- POLEA DE DIST.	
4 CIL. 1.6 L	1989	TCKWP077	KIT DE DISTRIBUCION CON B.A.	
4 CIL. 1.6 L	1988	T41058	SENSOR- POLEA DE DIST.	
4 CIL. 1.6 L	1988	TCKWP077	KIT DE DISTRIBUCION CON B.A.	
4 CIL. 1.6 L	1987	T41058	SENSOR- POLEA DE DIST.	
4 CIL. 1.6 L	1987	TCKWP077	KIT DE DISTRIBUCION CON B.A.	
4 CIL. 1.6 L	1986	T41058	SENSOR- POLEA DE DIST.	
4 CIL. 1.6 L	1986	TCKWP077	KIT DE DISTRIBUCION CON B.A.	
4 CIL. 1.6 L	1985	T41058	SENSOR- POLEA DE DIST.	
4 CIL. 1.6 L	1985	TCKWP077	KIT DE DISTRIBUCION CON B.A.	
4 CIL. 1.6 L	1984	T41058	SENSOR- POLEA DE DIST.	
4 CIL. 1.6 L	1984	TCKWP077	KIT DE DISTRIBUCION CON B.A.	

**XTERRA**

V6. 4.0 L	2007	38378	SENSOR	
V6. 4.0 L	2006	38378	SENSOR	
4 CIL. 2.4 L	2004	38037	SENSOR	D.H.
4 CIL. 2.4 L	2003	38037	SENSOR	
4 CIL. 2.4 L	2002	38037	SENSOR	
V6. 3.3 L	2002	TCK249	KIT DE DISTRIBUCION	
		T41059	SENSOR- POLEA DE DIST.	
4 CIL. 2.4 L	2001	36116	POLEA	A.A.
		38037	SENSOR	
V6. 3.3 L	2001	TCK249	KIT DE DISTRIBUCION	
		38005	SENSOR	VENTILADOR Y D.H.
		T41059	SENSOR- POLEA DE DIST.	
4 CIL. 2.4 L	2000	36116	POLEA	A.A.
		38037	SENSOR	D.H.
V6. 3.3 L	2000	TCK249	KIT DE DISTRIBUCION	
		38005	SENSOR	VENTILADOR Y D.H.
		T41059	SENSOR- POLEA DE DIST.	

**OLDSMOBILE**

**ACHIEVA**

V6. 3.3 L	1993	38128	SENSOR PARA BANDA MICRO-V	
V6. 3.3 L	1992	38128	SENSOR PARA BANDA MICRO-V	

**AURORA**

V6. 3.5 L	2002	38166	SENSOR PARA BANDA MICRO-V	
V6. 3.5 L	2001	38166	SENSOR PARA BANDA MICRO-V	

**CUTLASS CIERA**

V6. 3.3 L	1993	38128	SENSOR PARA BANDA MICRO-V	
V6. 3.3 L	1992	38128	SENSOR PARA BANDA MICRO-V	

**CUTLASS CRUISER**

V6. 3.3 L	1993	38128	SENSOR PARA BANDA MICRO-V	
V6. 3.3 L	1992	38128	SENSOR PARA BANDA MICRO-V	

**CUTLASS SUPREME**

V6. 3.4 L	1996	T42113	SENSOR- POLEA DE DIST.	POLEA TENSORA
		T41209	SENSOR- POLEA DE DIST.	
V6. 3.4 L	1995	T41209	SENSOR- POLEA DE DIST.	POLEA TENSORA
		T42113	SENSOR- POLEA DE DIST.	
V6. 3.4 L	1994	T41209	SENSOR- POLEA DE DIST.	POLEA TENSORA
		T42113	SENSOR- POLEA DE DIST.	
V6. 3.4 L	1993	T41209	SENSOR- POLEA DE DIST.	POLEA TENSORA

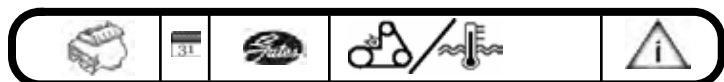

V6, 3.4 L	1993	T42113	TENSOR- POLEA DE DIST.	POLEA TENSORA
V6, 3.4 L	1992	T42113	TENSOR- POLEA DE DIST.	POLEA TENSORA
		T41209	TENSOR- POLEA DE DIST.	

**EIGHTY EIGHT**

V6, 3.8 L	1999	38006	TENSOR	
		38289	TENSOR	
		38009	TENSOR	C/Supercargador
		38007	TENSOR	C/Supercargador
V6, 3.8 L	1998	38152	TENSOR	
		38015	TENSOR	
V6, 3.8 L	1995	38269	TENSOR PARA BANDA MICRO-V	ALT. Y D.H.
		38268	TENSOR PARA BANDA MICRO-V	SUPER CARGADO
V6, 3.8 L	1991	38120	TENSOR PARA BANDA MICRO-V	
V6, 3.8 L	1990	38120	TENSOR PARA BANDA MICRO-V	
V6, 3.8 L	1989	38120	TENSOR PARA BANDA MICRO-V	

**FIRENZA**

4 CIL. 2.0 L	1988	38199	TENSOR PARA BANDA MICRO-V	SERP.
4 CIL. 2.0 L	1987	38199	TENSOR PARA BANDA MICRO-V	SERP.

**INTRIGUE**

V6, 3.5 L	2002	38166	TENSOR PARA BANDA MICRO-V	
V6, 3.5 L	2001	38166	TENSOR PARA BANDA MICRO-V	
V6, 3.5 L	2000	38166	TENSOR PARA BANDA MICRO-V	
V6, 3.5 L	1999	38166	TENSOR PARA BANDA MICRO-V	

**NINETY EIGHT**

V6, 3.8 L	1991	38120	TENSOR PARA BANDA MICRO-V	
V6, 3.8 L	1990	38120	TENSOR PARA BANDA MICRO-V	
V6, 3.8 L	1989	38120	TENSOR PARA BANDA MICRO-V	
V6, 3.8 L	1988	38120	TENSOR PARA BANDA MICRO-V	

**SILHOUETTE**

V6, 3.4 L	1996	38105	TENSOR	
		38007	TENSOR	
V6, 3.8 L	1995	38126	TENSOR	
		38005	TENSOR	
		38027	TENSOR	
V6, 3.1 L	1994	38126	TENSOR	
V6, 3.8 L	1994	38027	TENSOR	
		38126	TENSOR	

**TORONADO**

V6, 3.8 L	1991	38120	TENSOR PARA BANDA MICRO-V	
V6, 3.8 L	1990	38120	TENSOR PARA BANDA MICRO-V	
V6, 3.8 L	1989	38120	TENSOR PARA BANDA MICRO-V	
V6, 3.8 L	1988	38120	TENSOR PARA BANDA MICRO-V	

**PEUGEOT**

**206**

4 CIL. 1.4 L	2008	TCK901AM	KIT DE DISTRIBUCION	
		T43023	TENSOR- POLEA DE DIST.	
		T43023	TENSOR- POLEA DE DIST.	
4 CIL.1.4 L	2008	TCK901AM	KIT DE DISTRIBUCION	
4 CIL. 1.4 L	2007	TCK901AM	KIT DE DISTRIBUCION	
		T43023	TENSOR- POLEA DE DIST.	
4 CIL.1.4 L	2007	TCK901AM	KIT DE DISTRIBUCION	
4 CIL. 1.4 L	2006	TCK901AM	KIT DE DISTRIBUCION	
		T43023	TENSOR- POLEA DE DIST.	
4 CIL.1.4 L	2006	TCK901AM	KIT DE DISTRIBUCION	
4 CIL. 1.4 L	2005	TCK901AM	KIT DE DISTRIBUCION	
		T43023	TENSOR- POLEA DE DIST.	
4 CIL.1.4 L	2005	TCK901AM	KIT DE DISTRIBUCION	



4 CIL. 1.4 L	2004	TCK901AM	KIT DE DISTRIBUCION	
		T43023	TENSOR- POLEA DE DIST.	
4 CIL.1.4 L	2004	TCK901AM	KIT DE DISTRIBUCION	
4 CIL. 1.4 L	2003	TCK901AM	KIT DE DISTRIBUCION	
		T43023	TENSOR- POLEA DE DIST.	
4 CIL.1.4 L	2003	TCK901AM	KIT DE DISTRIBUCION	
4 CIL. 1.4 L	2002	TCK901AM	KIT DE DISTRIBUCION	
		T43023	TENSOR- POLEA DE DIST.	
4 CIL. 1.4 L	2002	TCK901AM	KIT DE DISTRIBUCION	
4 CIL. 1.4 L	2001	TCK901M	KIT DE DISTRIBUCION	
		T43023	TENSOR- POLEA DE DIST.	
4 CIL.1.4 L	2001	TCK901M	KIT DE DISTRIBUCION	
4 CIL. 1.4 L	2000	TCK901M	KIT DE DISTRIBUCION	
		T43023	TENSOR- POLEA DE DIST.	
4 CIL.1.4 L	2000	TCK901M	KIT DE DISTRIBUCION	
4 CIL. 1.4 L	1999	TCK901M	KIT DE DISTRIBUCION	
		T43023	TENSOR- POLEA DE DIST.	
4 CIL.1.4 L	1999	TCK901M	KIT DE DISTRIBUCION	
4 CIL. 1.4 L	1998	TCK901M	KIT DE DISTRIBUCION	
		T43023	TENSOR- POLEA DE DIST.	
4 CIL.1.4 L	1998	TCK901M	KIT DE DISTRIBUCION	

**207**

4 CIL. 1.6 L	2009	T43159	TENSOR- POLEA DE DIST.	
		T42191	TENSOR- POLEA DE DIST.	
		T38313	TENSOR- POLEA DE DIST.	
4 CIL. 1.6 L	2008	T42191	TENSOR- POLEA DE DIST.	
		T43159	TENSOR- POLEA DE DIST.	
		T38313	TENSOR- POLEA DE DIST.	

**307**

4 CIL. 2.0 L	2008	T41235	TENSOR- POLEA DE DIST.	
		T36109	TENSOR- POLEA DE DIST.	
		T38320	TENSOR- POLEA DE DIST.	
		T43022	TENSOR- POLEA DE DIST.	
4 CIL. 2.0 L	2007	T36109	TENSOR- POLEA DE DIST.	
		T41235	TENSOR- POLEA DE DIST.	
		T43022	TENSOR- POLEA DE DIST.	
4 CIL. 2.0 L	2006	T36109	TENSOR- POLEA DE DIST.	
		T38320	TENSOR- POLEA DE DIST.	
		T41235	TENSOR- POLEA DE DIST.	
		T43022	TENSOR- POLEA DE DIST.	
4 CIL. 2.0 L	2005	T36109	TENSOR- POLEA DE DIST.	
		T38320	TENSOR- POLEA DE DIST.	
		T41235	TENSOR- POLEA DE DIST.	
		T43022	TENSOR- POLEA DE DIST.	

**GRAND RAID**

4 CIL. 1.6 L	2008	T42066	TENSOR- POLEA DE DIST.	
		T43157	TENSOR- POLEA DE DIST.	
4 CIL. 1.6 L	2007	T42066	TENSOR- POLEA DE DIST.	
		T43157	TENSOR- POLEA DE DIST.	
4 CIL. 1.6 L	2006	T43157	TENSOR- POLEA DE DIST.	
		T42066	TENSOR- POLEA DE DIST.	
4 CIL. 1.6 L	2005	T43157	TENSOR- POLEA DE DIST.	
		T42066	TENSOR- POLEA DE DIST.	
4 CIL. 1.6 L	2004	T43157	TENSOR- POLEA DE DIST.	
		T42066	TENSOR- POLEA DE DIST.	

**PARTNER**

4 CIL. 1.6 L	2008	T42066	TENSOR- POLEA DE DIST.	
		T43157	TENSOR- POLEA DE DIST.	
4 CIL. 1.6 L	2007	T42066	TENSOR- POLEA DE DIST.	
		T43157	TENSOR- POLEA DE DIST.	
4 CIL. 1.6 L	2006	T42066	TENSOR- POLEA DE DIST.	
		T43157	TENSOR- POLEA DE DIST.	

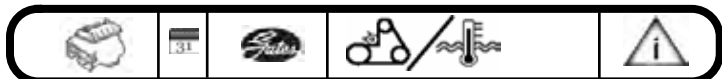

## PLYMOUTH

### BREEZE

4 CIL. 2.0 L	1998	TCKWP245	KIT DE DISTRIBUCION CON B.A.	
4 CIL. 2.0 L	1997	TCKWP245	KIT DE DISTRIBUCION CON B.A.	
4 CIL. 2.0 L	1996	TCKWP245	KIT DE DISTRIBUCION CON B.A.	
4 CIL. 2.0 L	1995	TCKWP245	KIT DE DISTRIBUCION CON B.A.	

### CARAVELLE

4 CIL. 2.2 L	1988	T41000	TENSOR- POLEA DE DIST.	
4 CIL. 2.2 L	1987	T41000	TENSOR- POLEA DE DIST.	
4 CIL. 2.2 L	1986	T41000	TENSOR- POLEA DE DIST.	
4 CIL. 2.2 L	1985	T41000	TENSOR- POLEA DE DIST.	
4 CIL. 2.2 L (Canada)	1984	T41000	TENSOR- POLEA DE DIST.	
4 CIL. 2.2 L (Canada)	1983	T41000	TENSOR- POLEA DE DIST.	

### COLT

4 CIL. 1.5 L (Canada)	1995	T41051	TENSOR- POLEA DE DIST.	
4 CIL. 1.5 L	1994	T41051	TENSOR- POLEA DE DIST.	
4 CIL. 1.8 L	1994	T41052	TENSOR- POLEA DE DIST.	BALANCIN
4 CIL. 2.4 L	1994	T41047	TENSOR- POLEA DE DIST.	
4 CIL. 1.5 L	1993	T41051	TENSOR- POLEA DE DIST.	
4 CIL. 1.8 L	1993	T41052	TENSOR- POLEA DE DIST.	BALANCIN
4 CIL. 2.4 L	1993	T41047	TENSOR- POLEA DE DIST.	
4 CIL. 1.5 L	1992	T41051	TENSOR- POLEA DE DIST.	
4 CIL. 1.8 L	1992	T41052	TENSOR- POLEA DE DIST.	BALANCIN
4 CIL. 2.4 L	1992	T41053	TENSOR- POLEA DE DIST.	
4 CIL. 1.5 L	1991	T41042	TENSOR- POLEA DE DIST.	
		T41051	TENSOR- POLEA DE DIST.	
4 CIL. 1.5 L	1990	T41042	TENSOR- POLEA DE DIST.	
4 CIL. 1.6 L	1990	T41046	TENSOR- POLEA DE DIST.	(DEL TENSOR)
		T41056	TENSOR- POLEA DE DIST.	
4 CIL. 1.8 L	1990	T41056	TENSOR- POLEA DE DIST.	
4 CIL. 1.5 L	1989	T41042	TENSOR- POLEA DE DIST.	
4 CIL. 1.6 L	1989	T41046	TENSOR- POLEA DE DIST.	(DEL TENSOR)
		T41056	TENSOR- POLEA DE DIST.	
4 CIL. 1.8 L	1989	T41056	TENSOR- POLEA DE DIST.	
4 CIL. 2.0 L	1989	T41045	TENSOR- POLEA DE DIST.	BALANCIN
4 CIL. 1.5 L	1988	T41042	TENSOR- POLEA DE DIST.	
4 CIL. 1.6 L	1988	T41056	TENSOR- POLEA DE DIST.	
4 CIL. 2.0 L	1988	T41045	TENSOR- POLEA DE DIST.	BALANCIN
4 CIL. 1.5 L	1987	T41042	TENSOR- POLEA DE DIST.	
4 CIL. 1.6 L	1987	T41056	TENSOR- POLEA DE DIST.	
		T41055	TENSOR- POLEA DE DIST.	
4 CIL. 2.0 L	1987	T41045	TENSOR- POLEA DE DIST.	BALANCIN
4 CIL. 1.5 L	1986	T41042	TENSOR- POLEA DE DIST.	
4 CIL. 1.6 L	1986	T41055	TENSOR- POLEA DE DIST.	
4 CIL. 2.0 L	1986	T41053	TENSOR- POLEA DE DIST.	BALANCIN
		T41043	TENSOR- POLEA DE DIST.	
4 CIL. 1.5 L	1985	T41042	TENSOR- POLEA DE DIST.	
4 CIL. 1.6 L	1985	T41055	TENSOR- POLEA DE DIST.	
4 CIL. 1.4 L	1984	T41042	TENSOR- POLEA DE DIST.	
4 CIL. 1.6 L	1984	T41055	TENSOR- POLEA DE DIST.	
4 CIL. 1.4 L	1983	T41042	TENSOR- POLEA DE DIST.	
4 CIL. 1.6 L	1983	T41055	TENSOR- POLEA DE DIST.	

### GRAN FURY

V8, 5.2 L	1989	36103	POLEA	POLEA LOCA
V8, 5.2 L	1988	36103	POLEA	POLEA LOCA
V8, 5.2 L	1987	36103	POLEA	POLEA LOCA
V8, 5.2 L	1986	36103	POLEA	POLEA LOCA
V8, 5.2 L	1985	36103	POLEA	POLEA LOCA

### HORIZON

4 CIL. 2.2 L	1988	T41000	TENSOR- POLEA DE DIST.	
--------------	------	--------	------------------------	--

	1987	T41000	TENSOR- POLEA DE DIST.	
4 CIL. 2.2 L	1986	T41000	TENSOR- POLEA DE DIST.	
4 CIL. 2.2 L	1985	T41000	TENSOR- POLEA DE DIST.	
4 CIL. 2.2 L	1984	T41000	TENSOR- POLEA DE DIST.	
4 CIL. 2.2 L	1983	T41000	TENSOR- POLEA DE DIST.	
4 CIL. 2.2 L	1982	T41000	TENSOR- POLEA DE DIST.	
4 CIL. 2.2 L	1981	T41000	TENSOR- POLEA DE DIST.	

### LASER

4 CIL. 1.8 L	1994	T41057	TENSOR- POLEA DE DIST.	BALANCIN
		T41056	TENSOR- POLEA DE DIST.	
4 CIL. 2.0 L	1994	T41046	TENSOR- POLEA DE DIST.	(DEL TENSOR)
		T41047	TENSOR- POLEA DE DIST.	BALANCIN
4 CIL. 1.8 L	1993	T41057	TENSOR- POLEA DE DIST.	BALANCIN
		T41056	TENSOR- POLEA DE DIST.	
4 CIL. 2.0 L	1993	T41047	TENSOR- POLEA DE DIST.	BALANCIN
		T41046	TENSOR- POLEA DE DIST.	(DEL TENSOR)
4 CIL. 1.8 L	1992	T41056	TENSOR- POLEA DE DIST.	
		T41057	TENSOR- POLEA DE DIST.	BALANCIN
4 CIL. 2.0 L	1992	T41046	TENSOR- POLEA DE DIST.	(DEL TENSOR)
		T41047	TENSOR- POLEA DE DIST.	BALANCIN
4 CIL. 1.8 L	1991	T41057	TENSOR- POLEA DE DIST.	BALANCIN
		T41056	TENSOR- POLEA DE DIST.	
4 CIL. 2.0 L	1991	T41047	TENSOR- POLEA DE DIST.	BALANCIN
		T41046	TENSOR- POLEA DE DIST.	(DEL TENSOR)
4 CIL. 1.8 L	1990	T41056	TENSOR- POLEA DE DIST.	
		T41057	TENSOR- POLEA DE DIST.	BALANCIN
4 CIL. 2.0 L	1990	T41046	TENSOR- POLEA DE DIST.	(DEL TENSOR)
		T41047	TENSOR- POLEA DE DIST.	BALANCIN

### NEON

4 CIL. 2.0 L	2001	T43132	TENSOR- POLEA DE DIST.	
4 CIL. 2.0 L	2000	T43132	TENSOR- POLEA DE DIST.	
4 CIL. 2.0 L	1999	T43132	TENSOR- POLEA DE DIST.	
4 CIL. 2.0 L	1998	TCKWP245	KIT DE DISTRIBUCION CON B.A.	
		T43132	TENSOR- POLEA DE DIST.	
4 CIL. 2.0 L	1997	TCKWP245	KIT DE DISTRIBUCION CON B.A.	
		T43132	TENSOR- POLEA DE DIST.	
4 CIL. 2.0 L	1996	TCKWP245	KIT DE DISTRIBUCION CON B.A.	
		T43132	TENSOR- POLEA DE DIST.	
4 CIL. 2.0 L	1995	TCKWP245	KIT DE DISTRIBUCION CON B.A.	
		T43132	TENSOR- POLEA DE DIST.	

### RELIANT

4 CIL. 2.2 L	1988	T41000	TENSOR- POLEA DE DIST.	
4 CIL. 2.2 L	1987	T41000	TENSOR- POLEA DE DIST.	
4 CIL. 2.2 L	1986	T41000	TENSOR- POLEA DE DIST.	
4 CIL. 2.2 L	1985	T41000	TENSOR- POLEA DE DIST.	
4 CIL. 2.2 L	1984	T41000	TENSOR- POLEA DE DIST.	
4 CIL. 2.2 L	1983	T41000	TENSOR- POLEA DE DIST.	
4 CIL. 2.2 L	1982	T41000	TENSOR- POLEA DE DIST.	
4 CIL. 2.2 L	1981	T41000	TENSOR- POLEA DE DIST.	

### SUNDANCE

4 CIL. 2.2 L	1988	T41000	TENSOR- POLEA DE DIST.	
4 CIL. 2.2 L	1987	T41000	TENSOR- POLEA DE DIST.	

### VOYAGER

V6, 3.0 L	2000	TCKWP139	KIT DE DISTRIBUCION CON B.A.	
V6, 3.0 L	1999	TCKWP139	KIT DE DISTRIBUCION CON B.A.	
V6, 3.0 L	1998	TCKWP139	KIT DE DISTRIBUCION CON B.A.	
V6, 3.0 L	1997	TCKWP139	KIT DE DISTRIBUCION CON B.A.	
V6, 3.0 L	1996	TCKWP139	KIT DE DISTRIBUCION CON B.A.	
V6, 3.0 L	1995	TCKWP139	KIT DE DISTRIBUCION CON B.A.	
V6, 3.0 L	1994	TCKWP139	KIT DE DISTRIBUCION CON B.A.	
V6, 3.0 L	1993	TCKWP139	KIT DE DISTRIBUCION CON B.A.	
V6, 3.0 L	1992	TCKWP139	KIT DE DISTRIBUCION CON B.A.	
V6, 3.0 L	1991	TCKWP139	KIT DE DISTRIBUCION CON B.A.	
V6, 3.0 L	1990	TCKWP139	KIT DE DISTRIBUCION CON B.A.	

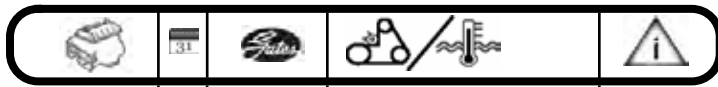

V6, 3.0 L	1989	TCKWP139	KIT DE DISTRIBUCION CON B.A.	
V6, 3.0 L	1988	TCKWP139	KIT DE DISTRIBUCION CON B.A.	
4 CIL. 2.2 L	1987	T41000	SENSOR- POLEA DE DIST.	
V6, 3.0 L	1987	TCKWP139	KIT DE DISTRIBUCION CON B.A.	
4 CIL. 2.2 L	1986	T41000	SENSOR- POLEA DE DIST.	
4 CIL. 2.2 L	1985	T41000	SENSOR- POLEA DE DIST.	
4 CIL. 2.2 L	1984	T41000	SENSOR- POLEA DE DIST.	



V6, 3.8 L	1994	38268	SENSOR	SC
		38126	SENSOR	
		38015	SENSOR	
		38006	SENSOR	
V6, 3.8 L	1991	38120	SENSOR PARA BANDA MICRO-V	
V6, 3.8 L	1990	38120	SENSOR PARA BANDA MICRO-V	
V6, 3.8 L	1989	38120	SENSOR PARA BANDA MICRO-V	

## PONTIAC

### AZTEK

V6, 3.4 L	2005	38104	SENSOR	LOCA
		38043	SENSOR	
		38009	SENSOR	
V6, 3.4 L	2004	38006	SENSOR	
		38104	SENSOR	
		38043	SENSOR	
		38006	SENSOR	
		38009	SENSOR	
V6, 3.4 L	2003	38104	SENSOR	
		38043	SENSOR	
		38006	SENSOR	
		38009	SENSOR	
V6, 3.4 L	2002	38104	SENSOR	
		38006	SENSOR	
		38009	SENSOR	
V6, 3.4 L	2001	38104	SENSOR	
		38009	SENSOR	
		38006	SENSOR	

### FIREBIRD TRANS AM

V8, 5.7 L	2002	38006	SENSOR	
		38008	SENSOR	
V8, 5.7 L	2001	38008	SENSOR	
		38006	SENSOR	
V8, 5.7 L	2000	38006	SENSOR	
		38008	SENSOR	
V8, 5.7 L	1999	38008	SENSOR	
		38006	SENSOR	
V8, 5.7 L	1998	38008	SENSOR	
		38006	SENSOR	
V8, 5.7 L	1997	38145	SENSOR	
		38001	SENSOR	

### FIREFLY

3 CIL. 1.0 L (Canada)	2000	T41010	SENSOR- POLEA DE DIST.	
3 CIL. 1.0 L (Canada)	1999	T41010	SENSOR- POLEA DE DIST.	
3 CIL. 1.0 L (Canada)	1998	T41010	SENSOR- POLEA DE DIST.	
3 CIL. 1.0 L (Canada)	1997	T41010	SENSOR- POLEA DE DIST.	
3 CIL. 1.0 L (Canada)	1996	T41010	SENSOR- POLEA DE DIST.	
3 CIL. 1.0 L (Canada)	1991	T41009	SENSOR- POLEA DE DIST.	
3 CIL. 1.0 L (Canada)	1990	T41009	SENSOR- POLEA DE DIST.	
3 CIL. 1.0 L (Canada)	1989	T41009	SENSOR- POLEA DE DIST.	

### BONNEVILLE

V6, 3.8 L	2005	38271	SENSOR	LISA, SC
		38006	SENSOR	
		38271	SENSOR	
V6, 3.8 L	2004	38006	SENSOR	
V6, 3.8 L	2003	38271	SENSOR	
		38007	SENSOR	
		38006	SENSOR	
V6, 3.8 L	2002	38007	SENSOR	RANURADA, SC C/Supercargador
		38009	SENSOR	C/Supercargador
V6, 3.8 L	2001	38007	SENSOR	C/Supercargador
		38009	SENSOR	C/Supercargador
V6, 3.8 L	2000	38009	SENSOR	C/Supercargador
		38007	SENSOR	
V6, 3.8 L	1999	38006	SENSOR	C/Supercargador
		38009	SENSOR	
		38007	SENSOR	
V6, 3.8 L	1998	38152	SENSOR	SUPER CARGADO
		38015	SENSOR	
		38006	SENSOR	
		38007	SENSOR	
		38009	SENSOR	
V6, 3.8 L	1997	38152	SENSOR	SUPER CARGADO C/CANALE:
		38006	SENSOR	SUPER CARGADO
		38009	SENSOR	SUPER CARGADO C/CANALE:
		38015	SENSOR	
		38007	SENSOR	
V6, 3.8 L	1996	38152	SENSOR	SUPER CARGADO
		38006	SENSOR	
		38007	SENSOR	
		38009	SENSOR	
		38015	SENSOR	
V6, 3.8 L	1995	38268	SENSOR	SC
		38152	SENSOR	ACCESORIO
		38269	SENSOR	ALT. & D.H. C/SC
		38006	SENSOR	
		38015	SENSOR	SUPER CARGADO (LISO)
		38009	SENSOR	SUPER CARGADO C/CANALE:

### G3

4 CIL. 1.6 L	2008	38376	SENSOR	SIN A.A.
		38024	SENSOR	
		38015	SENSOR	
		T43039	SENSOR- POLEA DE DIST.	
4 CIL. 1.6 L	2007	38376	SENSOR	SIN A.A.
		38024	SENSOR	
		38015	SENSOR	
		T43039	SENSOR- POLEA DE DIST.	
4 CIL. 1.6 L	2006	38024	SENSOR	SIN A.A.
		38376	SENSOR	
		38015	SENSOR	
		T43039	SENSOR- POLEA DE DIST.	

### G4

4 CIL. 2.2 L	2006	38177	SENSOR	
		38011	SENSOR	
4 CIL. 2.4 L	2006	38177	SENSOR	
		38011	SENSOR	

### G5

4 CIL. 2.2 L	2008	38177	SENSOR	
		38011	SENSOR	
4 CIL. 2.4 L	2008	38177	SENSOR	
		38011	SENSOR	
4 CIL. 2.2 L	2007	38177	SENSOR	
		38011	SENSOR	
4 CIL. 2.4 L	2007	38177	SENSOR	
		38011	SENSOR	

### G6

V6, 3.5 L	2008	38420	SENSOR	REQUIERE 2
		38006	SENSOR	
		38009	SENSOR	
V6, 3.6 L	2008	38397	SENSOR	
V6, 3.5 L	2007	38420	SENSOR	

V6, 3.5 L	2007	38009	SENSOR	
		38006	SENSOR	REQUIERE 2
V6, 3.6 L	2007	38397	SENSOR	
V6, 3.5 L	2006	38104	SENSOR	
		38043	SENSOR	REQUIERE 2
		38009	SENSOR	
V6, 3.9 L	2006	38104	SENSOR	
		38006	SENSOR	REQUIERE 2
		38009	SENSOR	

V6, 3.1 L	2001	38009	SENSOR	C/Supercargador
		38105	SENSOR	
		38001	SENSOR	
V6, 3.8 L	2001	38009	SENSOR	C/Supercargador
		38006	SENSOR	
		38007	SENSOR	C/Supercargador
V6, 3.1 L	2000	38105	SENSOR	
		38001	SENSOR	
V6, 3.8 L	2000	38007	SENSOR	C/Supercargador
		38009	SENSOR	C/Supercargador
		38006	SENSOR	
V6, 3.1 L	1999	38105	SENSOR	
		38001	SENSOR	
V6, 3.8 L	1999	38006	SENSOR	
		38009	SENSOR	C/Supercargador
		38007	SENSOR	C/Supercargador
V6, 3.1 L	1998	38105	SENSOR	
		38001	SENSOR	
V6, 3.8 L	1998	38152	SENSOR	
		38009	SENSOR	
		38015	SENSOR	
		38007	SENSOR	
V6, 3.1 L	1997	38105	SENSOR	
		38007	SENSOR	
V6, 3.8 L	1997	38152	SENSOR	
		38015	SENSOR	
		38007	SENSOR	
		38009	SENSOR	
		38006	SENSOR	
V6, 3.4 L	1996	T41209	SENSOR- POLEA DE DIST.	
		T42113	SENSOR- POLEA DE DIST.	POLEA TENSORA
V6, 3.4 L	1995	T41209	SENSOR- POLEA DE DIST.	
		T42113	SENSOR- POLEA DE DIST.	POLEA TENSORA
V6, 3.4 L	1994	T41209	SENSOR- POLEA DE DIST.	
		T42113	SENSOR- POLEA DE DIST.	POLEA TENSORA
V6, 3.4 L	1993	T41209	SENSOR- POLEA DE DIST.	
		T42113	SENSOR- POLEA DE DIST.	POLEA TENSORA
V6, 3.4 L	1992	T41209	SENSOR- POLEA DE DIST.	
		T42113	SENSOR- POLEA DE DIST.	POLEA TENSORA

**G8**

V6, 3.6 L	2009	38397	SENSOR	
V8, 6.0 L	2009	38462	SENSOR	A.A.
		38328	SENSOR	SERPENTIN
		38462	SENSOR PARA BANDA MICRO-V	AIRE ACONDICIONADO

**GRAND AM**

V6, 3.4 L	2005	38104	SENSOR	
		38009	SENSOR	
		38006	SENSOR	LOCA
V6, 3.4 L	2004	38104	SENSOR	
		38009	SENSOR	
		38006	SENSOR	
4 CIL. 2.2 L	2003	38177	SENSOR	
		38011	SENSOR	
V6, 3.4 L	2003	38104	SENSOR	
		38006	SENSOR	
		38009	SENSOR	
4 CIL. 2.2 L	2002	38177	SENSOR	
		38011	SENSOR	
V6, 3.4 L	2002	38104	SENSOR	
		38009	SENSOR	
		38006	SENSOR	
4 CIL. 2.4 L	2001	38247	SENSOR	
V6, 3.4 L	2001	38104	SENSOR	
		38009	SENSOR	
		38006	SENSOR	
V6, 3.4 L	2000	38104	SENSOR	
		38009	SENSOR	
		38006	SENSOR	
4 CIL. 2.4 L	1999	38146	SENSOR	1er diseño
		38011	SENSOR	1er diseño
V6, 3.4 L	1999	38104	SENSOR	
		38009	SENSOR	
		38006	SENSOR	
V6, 3.1 L	1997	38105	SENSOR	
		38007	SENSOR	
V6, 3.3 L	1993	38128	SENSOR PARA BANDA MICRO-V	
V6, 3.3 L	1992	38128	SENSOR PARA BANDA MICRO-V	
4 CIL. 2.0 L	1989	38199	SENSOR PARA BANDA MICRO-V	Ait. & D.H.
		T43002	SENSOR- POLEA DE DIST.	
4 CIL. 2.0 L	1988	38199	SENSOR PARA BANDA MICRO-V	Ait. & D.H.
4 CIL. 2.0 L	1987	38199	SENSOR PARA BANDA MICRO-V	Ait. & D.H.

**LEMANS**

4 CIL. 2.0 L	1990	38199	SENSOR PARA BANDA MICRO-V	Ait. & D.H.
		T43002	SENSOR- POLEA DE DIST.	
4 CIL. 2.0 L	1989	38199	SENSOR PARA BANDA MICRO-V	Ait. & D.H.
		T43002	SENSOR- POLEA DE DIST.	

**MATIZ G2**

4 CIL. 1.0 L	2009	T41267	SENSOR- POLEA DE DIST.	
4 CIL. 1.0 L	2009	TCK1570M	KIT DE DISTRIBUCION	
4 CIL. 1.0 L	2008	T41267	SENSOR- POLEA DE DIST.	
4 CIL. 1.0 L	2008	TCK1570M	KIT DE DISTRIBUCION	
4 CIL. 1.0 L	2007	T41267	SENSOR- POLEA DE DIST.	
4 CIL. 1.0 L	2007	TCK1570M	KIT DE DISTRIBUCION	
4 CIL. 1.0 L	2006	T41267	SENSOR- POLEA DE DIST.	
4 CIL. 1.0 L	2006	TCK1570M	KIT DE DISTRIBUCION	
4 CIL. 1.0 L	2005	T41267	SENSOR- POLEA DE DIST.	
4 CIL. 1.0 L	2005	TCK1570M	KIT DE DISTRIBUCION	
4 CIL. 1.0 L	2004	T41267	SENSOR- POLEA DE DIST.	
4 CIL. 1.0 L	2004	TCK1570M	KIT DE DISTRIBUCION	
4 CIL. 1.0 L	2003	T41267	SENSOR- POLEA DE DIST.	
4 CIL. 1.0 L	2003	TCK1570M	KIT DE DISTRIBUCION	

**GRAND PRIX**

V6, 3.8 L	2005	38271	SENSOR	ACCESORIOS
		38001	SENSOR	LISA, SC
		38006	SENSOR	ACCESORIOS
		38009	SENSOR	RANURADA, SC
V6, 3.8 L	2004	38271	SENSOR	ACCESORIOS
		38009	SENSOR	RANURADA, SC
		38006	SENSOR	ACCESORIOS
		38001	SENSOR	LISA, SC
V6, 3.8 L	2003	38271	SENSOR	ACCESORIOS
		38006	SENSOR	ACCESORIOS
		38001	SENSOR	LISA, SC
		38009	SENSOR	RANURADA, SC
V6, 3.1 L	2002	38105	SENSOR	
		38001	SENSOR	
V6, 3.8 L	2002	38007	SENSOR	C/Supercargador

**MONTANA**

V6, 3.9 L	2008	38420	SENSOR	
		38006	SENSOR	REQUIERE 2
		38009	SENSOR	
V6, 3.9 L	2007	38420	SENSOR	
		38009	SENSOR	
		38006	SENSOR	REQUIERE 2

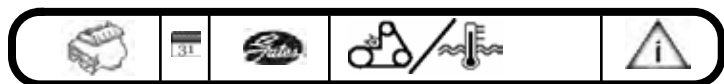

V6, 3.5 L	2006	38043	TENSOR	
		38104	TENSOR	
		38009	TENSOR	
V6, 3.9 L	2006	38420	TENSOR	
		38006	TENSOR	REQUIERE 2
		38009	TENSOR	



4 CIL. 2.2 L	1998	38164	TENSOR	
		38015	TENSOR	
		38011	TENSOR	
4 CIL. 2.4 L	1998	38146	TENSOR	
		38011	TENSOR	
4 CIL. 2.2 L	1997	38026	TENSOR	
		38110	TENSOR	
4 CIL. 2.4 L	1997	38146	TENSOR	
		38011	TENSOR	
4 CIL. 2.2 L	1996	38026	TENSOR	
		38110	TENSOR	
4 CIL. 2.4 L	1996	38146	TENSOR	
		38011	TENSOR	
4 CIL. 2.2 L	1995	38110	TENSOR	
		38026	TENSOR	
4 CIL. 2.3 L	1995	38146	TENSOR	
		38011	TENSOR	

**SOLSTICE**

4 CIL. 2.4 L	2008	38177	TENSOR	ALT. Y A/A
		38011	TENSOR	ALT. Y A/A
4 CIL. 2.4 L	2007	38177	TENSOR	ALT. Y A/A
		38011	TENSOR	ALT. Y A/A
4 CIL. 2.4 L	2006	38177	TENSOR	ALT. Y A/A
		38011	TENSOR	ALT. Y A/A

**SUNBIRD**

4 CIL. 2.0 L	1994	TCKWP163	KIT DE DISTRIBUCION CON B.A.	
		38199	TENSOR PARA BANDA MICRO-V	Alt. & D.H.
		T43002	TENSOR- POLEA DE DIST.	
4 CIL. 2.0 L	1993	TCKWP163	KIT DE DISTRIBUCION CON B.A.	
		38199	TENSOR PARA BANDA MICRO-V	Alt. & D.H.
		T43002	TENSOR- POLEA DE DIST.	
4 CIL. 2.0 L	1992	TCKWP163	KIT DE DISTRIBUCION CON B.A.	
		38199	TENSOR PARA BANDA MICRO-V	Alt. & D.H.
		T43002	TENSOR- POLEA DE DIST.	
4 CIL. 2.0 L	1991	TCKWP163	KIT DE DISTRIBUCION CON B.A.	
		38199	TENSOR PARA BANDA MICRO-V	Alt. & D.H.
		T43002	TENSOR- POLEA DE DIST.	
4 CIL. 2.0 L	1990	TCKWP163	KIT DE DISTRIBUCION CON B.A.	
		38199	TENSOR PARA BANDA MICRO-V	Alt. & D.H.
		T43002	TENSOR- POLEA DE DIST.	
4 CIL. 2.0 L	1989	38199	TENSOR PARA BANDA MICRO-V	Alt. & D.H.
		T43002	TENSOR- POLEA DE DIST.	
4 CIL. 2.0 L	1988	38199	TENSOR PARA BANDA MICRO-V	Alt. & D.H.
4 CIL. 2.0 L	1987	38199	TENSOR PARA BANDA MICRO-V	Alt. & D.H.

**SUNBURST**

4 CIL. 1.5 L (Canada)	1988	T41201	TENSOR- POLEA DE DIST.	
4 CIL. 1.5 L (Canada)	1987	T41201	TENSOR- POLEA DE DIST.	
4 CIL. 1.5 L (Canada)	1986	T41201	TENSOR- POLEA DE DIST.	
4 CIL. 1.5 L (Canada)	1985	T41201	TENSOR- POLEA DE DIST.	

**SUNFIRE**

4 CIL. 2.2 L	2005	38177	TENSOR	
		38011	TENSOR	
4 CIL. 2.2 L	2004	38177	TENSOR	
		38011	TENSOR	
4 CIL. 2.2 L	2003	38177	TENSOR	
		38011	TENSOR	
4 CIL. 2.2 L	2002	38177	TENSOR	
		38164	TENSOR	
		38015	TENSOR	
		38011	TENSOR	
4 CIL. 2.4 L	2002	38247	TENSOR	
		38032	TENSOR	
4 CIL. 2.2 L	2001	38164	TENSOR	
		38015	TENSOR	
		38011	TENSOR	
4 CIL. 2.4 L	2001	38032	TENSOR	
		38247	TENSOR	
4 CIL. 2.2 L	2000	38164	TENSOR	
		38015	TENSOR	
		38011	TENSOR	
4 CIL. 2.4 L	2000	38032	TENSOR	
		38247	TENSOR	
4 CIL. 2.2 L	1999	38164	TENSOR	
		38011	TENSOR	
		38015	TENSOR	
4 CIL. 2.4 L	1999	38032	TENSOR	
		38247	TENSOR	

**TORRENT**

V6, 3.4 L	2008	38043	TENSOR	REQUIERE 2
		38104	TENSOR	
		38009	TENSOR	
V6, 3.4 L	2007	38043	TENSOR	REQUIERE 2
		38104	TENSOR	
		38009	TENSOR	
V6, 3.4 L	2006	38043	TENSOR	REQUIERE 2
		38104	TENSOR	
		38009	TENSOR	

**TRANSPORT**

V6, 3.4 L	1999	38006	POLEA	CANADA
		38009	POLEA	CANADA
		38104	TENSOR PARA BANDA MICRO-V	CANADA
V6, 3.4 L	1998	38001	POLEA	
V6, 3.4 L	1997	38007	POLEA	
		38105	TENSOR PARA BANDA MICRO-V	
V6, 3.4 L	1996	38007	POLEA	
		38105	TENSOR PARA BANDA MICRO-V	
V6, 3.1 L	1995	38007	POLEA	
		38009	POLEA	
		38105	TENSOR PARA BANDA MICRO-V	
V6, 3.8 L	1995	38027	POLEA	
		38005	POLEA	
		38126	TENSOR PARA BANDA MICRO-V	

**PORSCHE**

**911**

6 CIL. 3.4 L	2000	37014P	POLEA DECOPLADORA	
		37014P	POLEA DECOPLADORA	

**BOXSTER**

6 CIL. 2.7 L	2006	37014P	POLEA DECOPLADORA	
6 CIL. 3.2 L	2006	37014P	POLEA DECOPLADORA	
6 CIL. 2.7 L	2005	37014P	POLEA DECOPLADORA	
6 CIL. 3.2 L	2005	37014P	POLEA DECOPLADORA	
6 CIL. 2.7 L	2004	37014P	POLEA DECOPLADORA	
6 CIL. 3.2 L	2004	37014P	POLEA DECOPLADORA	
6 CIL. 2.7 L	2003	37014P	POLEA DECOPLADORA	
6 CIL. 3.2 L	2003	37014P	POLEA DECOPLADORA	
6 CIL. 2.7 L	2002	37014P	POLEA DECOPLADORA	
6 CIL. 3.2 L	2002	37014P	POLEA DECOPLADORA	
6 CIL. 2.7 L	2001	37014P	POLEA DECOPLADORA	
6 CIL. 3.2 L	2001	37014P	POLEA DECOPLADORA	
6 CIL. 2.7 L	2000	37014P	POLEA DECOPLADORA	
6 CIL. 3.2 L	2000	37014P	POLEA DECOPLADORA	

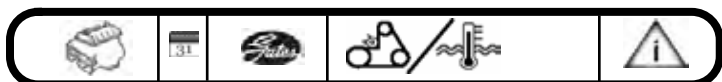

**RENAULT**

**CLIO**

4 CIL. 1.6 L	2009	TCK1095M T43064 T38456 T38484 T41237	KIT DE DISTRIBUCION TENSOR- POLEA DE DIST. TENSOR- POLEA DE DIST. TENSOR- POLEA DE DIST. TENSOR- POLEA DE DIST.	CON A.A. SIN A.A.
4 CIL. 1.6 L	2009	TCK1095M TCKWP1095M	KIT DE DISTRIBUCION KIT DE DISTRIBUCION CON B.A.	
4 CIL. 1.6 L	2008	TCK1095M T38456 T43064 T38484 T41237	KIT DE DISTRIBUCION TENSOR- POLEA DE DIST. TENSOR- POLEA DE DIST. TENSOR- POLEA DE DIST. TENSOR- POLEA DE DIST.	CON A.A. SIN A.A.
4 CIL. 1.6 L	2008	TCK1095M TCKWP1095M	KIT DE DISTRIBUCION KIT DE DISTRIBUCION CON B.A.	
4 CIL. 1.6 L	2007	TCK1095M T38484 T38456 T43064 T41237	KIT DE DISTRIBUCION TENSOR- POLEA DE DIST. TENSOR- POLEA DE DIST. TENSOR- POLEA DE DIST. TENSOR- POLEA DE DIST.	SIN A.A. CON A.A.
4 CIL. 1.6 L	2007	TCK1095M TCKWP1095M	KIT DE DISTRIBUCION KIT DE DISTRIBUCION CON B.A.	
4 CIL. 1.6 L	2006	TCK1095M T38484 T38456 T43064 T41237	KIT DE DISTRIBUCION TENSOR- POLEA DE DIST. TENSOR- POLEA DE DIST. TENSOR- POLEA DE DIST. TENSOR- POLEA DE DIST.	SIN A.A. CON A.A.
4 CIL. 2.0 L SPORT	2006	TPG-20001 TPG-20001 T42166 T42166	TENSOR ARBOL DE LEVAS TENSOR ARBOL DE LEVAS TENSOR- POLEA DE DIST. TENSOR- POLEA DE DIST.	
4 CIL. 1.6 L	2006	TCK1095M TCKWP1095M	KIT DE DISTRIBUCION KIT DE DISTRIBUCION CON B.A.	
4 CIL. 1.6 L	2005	TCK1095M T43064 T38456 T41237 T38484	KIT DE DISTRIBUCION TENSOR- POLEA DE DIST. TENSOR- POLEA DE DIST. TENSOR- POLEA DE DIST. TENSOR- POLEA DE DIST.	CON A.A. SIN A.A.
4 CIL. 2.0 L SPORT	2005	TPG-20001 T42166	TENSOR ARBOL DE LEVAS TENSOR- POLEA DE DIST.	
4 CIL. 1.6 L	2005	TCK1095M TCKWP1095M	KIT DE DISTRIBUCION KIT DE DISTRIBUCION CON B.A.	
4 CIL. 1.6 L	2004	TCK1095M T43064 T38484 T38456 T41237	KIT DE DISTRIBUCION TENSOR- POLEA DE DIST. TENSOR- POLEA DE DIST. TENSOR- POLEA DE DIST. TENSOR- POLEA DE DIST.	SIN A.A. CON A.A.
4 CIL. 2.0 L SPORT	2004	TPG-20001 T42166	TENSOR ARBOL DE LEVAS TENSOR- POLEA DE DIST.	
4 CIL. 1.6 L	2004	TCK1095M TCKWP1095M	KIT DE DISTRIBUCION KIT DE DISTRIBUCION CON B.A.	
4 CIL. 1.6 L	2003	TCK1095M T38456 T38484 T41237 T43064	KIT DE DISTRIBUCION TENSOR- POLEA DE DIST. TENSOR- POLEA DE DIST. TENSOR- POLEA DE DIST. TENSOR- POLEA DE DIST.	CON A.A. SIN A.A.
4 CIL. 2.0 L SPORT	2003	TPG-20001 T42166	TENSOR ARBOL DE LEVAS TENSOR- POLEA DE DIST.	
4 CIL. 1.6 L	2003	TCK1095M TCKWP1095M	KIT DE DISTRIBUCION KIT DE DISTRIBUCION CON B.A.	

**EUROCLIO**

4 CIL. 1.6 L	2008	TCK1095M T41237 T43064	KIT DE DISTRIBUCION TENSOR- POLEA DE DIST. TENSOR- POLEA DE DIST.	
4 CIL. 1.6 L	2007	TCK1095M	KIT DE DISTRIBUCION	

**KANGOO**

4 CIL. 1.6 L	2010	TCK1095M T41237 T38456 T38484 T43064	KIT DE DISTRIBUCION TENSOR- POLEA DE DIST. TENSOR- POLEA DE DIST. TENSOR- POLEA DE DIST. TENSOR- POLEA DE DIST.	CON A.A. SIN A.A.
4 CIL. 1.6 L	2010	TCK1095M TCKWP1095M	KIT DE DISTRIBUCION KIT DE DISTRIBUCION CON B.A.	
4 CIL. 1.6 L	2009	TCK1095M T38484 T41237 T43064 T38456	KIT DE DISTRIBUCION TENSOR- POLEA DE DIST. TENSOR- POLEA DE DIST. TENSOR- POLEA DE DIST. TENSOR- POLEA DE DIST.	SIN A.A. CON A.A.
4 CIL. 1.6 L	2009	TCK1095M TCKWP1095M	KIT DE DISTRIBUCION KIT DE DISTRIBUCION CON B.A.	
4 CIL. 1.6 L	2008	TCK1095M T41237 T38456 T38484 T43064	KIT DE DISTRIBUCION TENSOR- POLEA DE DIST. TENSOR- POLEA DE DIST. TENSOR- POLEA DE DIST. TENSOR- POLEA DE DIST.	CON A.A. SIN A.A.
4 CIL. 1.6 L	2008	TCK1095M TCKWP1095M	KIT DE DISTRIBUCION KIT DE DISTRIBUCION CON B.A.	
4 CIL. 1.6 L	2007	TCK1095M T38456 T41237 T38484 T43064	KIT DE DISTRIBUCION TENSOR- POLEA DE DIST. TENSOR- POLEA DE DIST. TENSOR- POLEA DE DIST. TENSOR- POLEA DE DIST.	CON A.A. SIN A.A.
4 CIL. 1.6 L	2007	TCK1095M TCKWP1095M	KIT DE DISTRIBUCION KIT DE DISTRIBUCION CON B.A.	
4 CIL. 1.6 L	2006	TCK1095M T41237 T43064 T38484 T38456	KIT DE DISTRIBUCION TENSOR- POLEA DE DIST. TENSOR- POLEA DE DIST. TENSOR- POLEA DE DIST. TENSOR- POLEA DE DIST.	SIN A.A. CON A.A.
4 CIL. 1.6 L	2006	TCK1095M TCKWP1095M	KIT DE DISTRIBUCION KIT DE DISTRIBUCION CON B.A.	
4 CIL. 1.6 L	2005	TCK1095M T43064 T38484 T38456 T41237	KIT DE DISTRIBUCION TENSOR- POLEA DE DIST. TENSOR- POLEA DE DIST. TENSOR- POLEA DE DIST. TENSOR- POLEA DE DIST.	SIN A.A. CON A.A.
4 CIL. 1.6 L	2005	TCK1095M TCKWP1095M	KIT DE DISTRIBUCION KIT DE DISTRIBUCION CON B.A.	
4 CIL. 1.6 L	2004	TCK1095M T38456 T41237 T38484	KIT DE DISTRIBUCION TENSOR- POLEA DE DIST. TENSOR- POLEA DE DIST. TENSOR- POLEA DE DIST.	CON A.A. SIN A.A.
4 CIL. 1.6 L	2004	TCK1095M TCKWP1095M	KIT DE DISTRIBUCION KIT DE DISTRIBUCION CON B.A.	
4 CIL. 1.6 L	2003	T41237 T38456 T38484	TENSOR- POLEA DE DIST. TENSOR- POLEA DE DIST. TENSOR- POLEA DE DIST.	CON A.A. SIN A.A.
4 CIL. 1.6 L	2003	TCK1095M TCKWP1095M	KIT DE DISTRIBUCION KIT DE DISTRIBUCION CON B.A.	

**KANGOO EXPRESS**

4 CIL. 1.6 L	2009	TCK1095M T43064 T38456 T38484 T41237	KIT DE DISTRIBUCION TENSOR- POLEA DE DIST. TENSOR- POLEA DE DIST. TENSOR- POLEA DE DIST. TENSOR- POLEA DE DIST.	CON A.A. SIN A.A.
4 CIL. 1.6 L	2008	TCK1095M T43064 T38456 T41237 T38484	KIT DE DISTRIBUCION TENSOR- POLEA DE DIST. TENSOR- POLEA DE DIST. TENSOR- POLEA DE DIST. TENSOR- POLEA DE DIST.	CON A.A. SIN A.A.
4 CIL. 1.6 L	2007	TCK1095M T43064	KIT DE DISTRIBUCION TENSOR- POLEA DE DIST.	

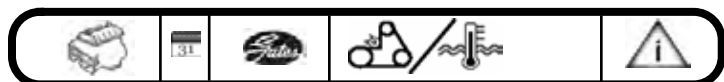

4 CIL. 1.6 L	2007	T38484	TENSOR- POLEA DE DIST.	SIN A.A.
		T41237	TENSOR- POLEA DE DIST.	
		T38456	TENSOR- POLEA DE DIST.	CON A.A.
4 CIL. 1.6 L	2006	TCK1095M	KIT DE DISTRIBUCION	
		T41237	TENSOR- POLEA DE DIST.	
		T38484	TENSOR- POLEA DE DIST.	SIN A.A.
		T38456	TENSOR- POLEA DE DIST.	CON A.A.
		T43064	TENSOR- POLEA DE DIST.	
4 CIL. 1.6 L	2005	TCK1095M	KIT DE DISTRIBUCION	
		T41237	TENSOR- POLEA DE DIST.	
		T43064	TENSOR- POLEA DE DIST.	
		T38456	TENSOR- POLEA DE DIST.	CON A.A.
		T38484	TENSOR- POLEA DE DIST.	SIN A.A.

**LAGUNA**

V6, 2.4 L	2006	T43166	TENSOR- POLEA DE DIST.	
		T43166	TENSOR- POLEA DE DIST.	
V6, 2.4 L	2005	T43166	TENSOR- POLEA DE DIST.	
4 CIL. 2.0 L	2004	TPG-20001	TENSOR ARBOL DE LEVAS	
V6, 2.4 L	2004	T43166	TENSOR- POLEA DE DIST.	
4 CIL. 2.0 L	2003	TPG-20001	TENSOR ARBOL DE LEVAS	
4 CIL. 2.0 L	2002	TPG-20001	TENSOR ARBOL DE LEVAS	
4 CIL. 2.0 L	2001	TPG-20001	TENSOR ARBOL DE LEVAS	

**MEGANE**

4 CIL. 2.0 L	2009	TCK1565M	KIT DE DISTRIBUCION	
		TPG-20001	TENSOR ARBOL DE LEVAS	
		T42166	TENSOR- POLEA DE DIST.	
		T42167	TENSOR- POLEA DE DIST.	
		T38428	TENSOR- POLEA DE DIST.	
4 CIL. 2.0 L	2008	TPG-20001	TENSOR ARBOL DE LEVAS	
		T42166	TENSOR- POLEA DE DIST.	
4 CIL. 2.0 L	2008	TCK1565M	KIT DE DISTRIBUCION	
		T42167	TENSOR- POLEA DE DIST.	
		T38428	TENSOR- POLEA DE DIST.	
4 CIL. 2.0 L	2007	TPG-20001	TENSOR ARBOL DE LEVAS	
		T42166	TENSOR- POLEA DE DIST.	
4 CIL. 2.0 L	2007	TCK1565M	KIT DE DISTRIBUCION	
		T38428	TENSOR- POLEA DE DIST.	
		T42167	TENSOR- POLEA DE DIST.	
4 CIL. 2.0 L	2006	TPG-20001	TENSOR ARBOL DE LEVAS	
		T42166	TENSOR- POLEA DE DIST.	
4 CIL. 2.0 L	2006	TCK1565M	KIT DE DISTRIBUCION	
		T38428	TENSOR- POLEA DE DIST.	
		T42167	TENSOR- POLEA DE DIST.	
4 CIL. 2.0 L	2005	TPG-20001	TENSOR ARBOL DE LEVAS	
		T42166	TENSOR- POLEA DE DIST.	
4 CIL. 2.0 L	2005	TCK1565M	KIT DE DISTRIBUCION	
		T42167	TENSOR- POLEA DE DIST.	
		T38428	TENSOR- POLEA DE DIST.	
4 CIL. 2.0 L	2004	TPG-20001	TENSOR ARBOL DE LEVAS	
		T42166	TENSOR- POLEA DE DIST.	
4 CIL. 2.0 L	2004	TCK1565M	KIT DE DISTRIBUCION	
		T42167	TENSOR- POLEA DE DIST.	
		T38428	TENSOR- POLEA DE DIST.	
4 CIL. 2.0 L	2003	TPG-20001	TENSOR ARBOL DE LEVAS	
		T42166	TENSOR- POLEA DE DIST.	
4 CIL. 2.0 L	2003	TCK1284M	KIT DE DISTRIBUCION	
4 CIL. 2.0 L	2002	TPG-20001	TENSOR ARBOL DE LEVAS	
		T42166	TENSOR- POLEA DE DIST.	
4 CIL. 2.0 L	2002	TCK1284M	KIT DE DISTRIBUCION	
4 CIL. 2.0 L	2001	TPG-20001	TENSOR ARBOL DE LEVAS	
		T42166	TENSOR- POLEA DE DIST.	
4 CIL. 2.0 L	2001	TCK1284M	KIT DE DISTRIBUCION	

**SANDERO**

4 CIL. 1.6 L	2010	TCK1095M	KIT DE DISTRIBUCION	
		T41237	TENSOR- POLEA DE DIST.	
		T43064	TENSOR- POLEA DE DIST.	



**SCENIC**

4 CIL. 2.0 L	2009	TPG-20001	TENSOR ARBOL DE LEVAS	
		T38428	TENSOR- POLEA DE DIST.	
		T42167	TENSOR- POLEA DE DIST.	
		T42166	TENSOR- POLEA DE DIST.	
4 CIL. 2.0 L	2008	T38428	TENSOR- POLEA DE DIST.	
		T42167	TENSOR- POLEA DE DIST.	
4 CIL. 2.0 L	2007	TPG-20001	TENSOR ARBOL DE LEVAS	
		T42166	TENSOR- POLEA DE DIST.	
4 CIL. 2.0 L	2007	T42167	TENSOR- POLEA DE DIST.	
		T38428	TENSOR- POLEA DE DIST.	
4 CIL. 2.0 L	2006	TPG-20001	TENSOR ARBOL DE LEVAS	
		T42166	TENSOR- POLEA DE DIST.	
4 CIL. 2.0 L	2006	T42167	TENSOR- POLEA DE DIST.	
		T38428	TENSOR- POLEA DE DIST.	
4 CIL. 2.0 L	2005	TPG-20001	TENSOR ARBOL DE LEVAS	
		T42166	TENSOR- POLEA DE DIST.	
4 CIL. 2.0 L	2005	T42167	TENSOR- POLEA DE DIST.	
		T38428	TENSOR- POLEA DE DIST.	
4 CIL. 2.0 L	2004	TPG-20001	TENSOR ARBOL DE LEVAS	
		T42166	TENSOR- POLEA DE DIST.	
4 CIL. 2.0 L	2004	T42167	TENSOR- POLEA DE DIST.	
		T38428	TENSOR- POLEA DE DIST.	
4 CIL. 2.0 L	2003	TPG-20001	TENSOR ARBOL DE LEVAS	
		T42166	TENSOR- POLEA DE DIST.	
4 CIL. 2.0 L	2003	TCK1284M	KIT DE DISTRIBUCION	
4 CIL. 2.0 L	2002	TPG-20001	TENSOR ARBOL DE LEVAS	
		T42166	TENSOR- POLEA DE DIST.	
4 CIL. 2.0 L	2002	TCK1284M	KIT DE DISTRIBUCION	
4 CIL. 2.0 L	2001	TPG-20001	TENSOR ARBOL DE LEVAS	
		T42166	TENSOR- POLEA DE DIST.	
4 CIL. 2.0 L	2001	TCK1284M	KIT DE DISTRIBUCION	

**STEPWAY**

4 CIL. 1.6 L	2010	TCK1095M	KIT DE DISTRIBUCION	
		T41237	TENSOR- POLEA DE DIST.	
		T43064	TENSOR- POLEA DE DIST.	

**TRAFIC**

4 CIL. 1.9 L DIESEL	2010	T41240	TENSOR- POLEA DE DIST.	
4 CIL. 1.9 L DIESEL	2009	T41240	TENSOR- POLEA DE DIST.	
4 CIL. 1.9 L DIESEL	2008	T41240	TENSOR- POLEA DE DIST.	

**SAAB**

**9 - 3**

4 CIL. 2.0 L	2007	38177	TENSOR	
V6, 2.8 L	2007	38397	TENSOR	
4 CIL. 2.0 L	2006	38011	POLEA	
		38011	TENSOR	
		38177	TENSOR	
		38177	TENSOR	
		38177	TENSOR PARA BANDA MICRO-V	
		38177	TENSOR PARA BANDA MICRO-V	
V6, 2.8 L	2006	38397	TENSOR	
4 CIL. 2.0 L	2005	38011	POLEA	
		38011	TENSOR	
		38177	TENSOR	
		38177	TENSOR	
		38177	TENSOR PARA BANDA MICRO-V	
		38177	TENSOR PARA BANDA MICRO-V	
4 CIL. 2.0 L	2004	38011	POLEA	
		38177	TENSOR	
		38177	TENSOR	
		38011	TENSOR	
		38177	TENSOR PARA BANDA MICRO-V	



4 CIL. 2.0 L	2004	38177	TENSOR PARA BANDA MICRO-V	
4 CIL. 2.0 L	2003	38011	POLEA	MOTOR. VIN S, Y
		38177	TENSOR	MOTOR. VIN S, Y
		38177	TENSOR	
		38011	TENSOR	MOTOR. VIN S, Y
		38226	TENSOR	MOTOR. VIN K
		38177	TENSOR PARA BANDA MICRO-V	
		38226	TENSOR PARA BANDA MICRO-V	MOTOR. VIN K
		38177	TENSOR PARA BANDA MICRO-V	MOTOR. VIN S, Y
4 CIL. 2.0 L	2002	36079	POLEA	
		36079	POLEA	
		38226	TENSOR	
		38226	TENSOR	
		38226	TENSOR PARA BANDA MICRO-V	
		38226	TENSOR PARA BANDA MICRO-V	
4 CIL. 2.3 L	2002	38226	TENSOR	
		38226	TENSOR	
		38226	TENSOR PARA BANDA MICRO-V	
		38226	TENSOR PARA BANDA MICRO-V	
4 CIL. 2.0 L	2001	38226	TENSOR	
		38226	TENSOR PARA BANDA MICRO-V	
4 CIL. 2.3 L	2001	38226	TENSOR	
		38226	TENSOR	
		38226	TENSOR PARA BANDA MICRO-V	
		38226	TENSOR PARA BANDA MICRO-V	
4 CIL. 2.0 L	2000	38226	TENSOR	
		38226	TENSOR PARA BANDA MICRO-V	
4 CIL. 2.3 L	2000	38226	TENSOR	
		38226	TENSOR PARA BANDA MICRO-V	

		38009	TENSOR	
		38179	TENSOR	
		38009	TENSOR	
		38179	TENSOR PARA BANDA MICRO-V	
		T41243	TENSOR- POLEA DE DIST.	
		T42086	TENSOR- POLEA DE DIST.	POLEA TENSORA
4 CIL. 2.3 L	2001	38226	TENSOR	
		38226	TENSOR PARA BANDA MICRO-V	
		TCK285	KIT DE DISTRIBUCION	
		38009	POLEA	
		38009	TENSOR	
		38179	TENSOR	
		38179	TENSOR PARA BANDA MICRO-V	
		T41243	TENSOR- POLEA DE DIST.	
		T42086	TENSOR- POLEA DE DIST.	POLEA TENSORA
		38083	POLEA	Chassis No. X3022043 & ANTE
		38226	TENSOR	
		38083	TENSOR	Chassis No. X3022043 & ANTE
		38226	TENSOR PARA BANDA MICRO-V	
		TCK285	KIT DE DISTRIBUCION	
		38009	POLEA	
		38009	TENSOR	
		38179	TENSOR	
		38179	TENSOR PARA BANDA MICRO-V	
		T42086	TENSOR- POLEA DE DIST.	POLEA TENSORA
		T41243	TENSOR- POLEA DE DIST.	
		T42086	TENSOR- POLEA DE DIST.	POLEA TENSORA
		T41243	TENSOR- POLEA DE DIST.	

**9 - 5**

4 CIL. 2.3 L	2007	36079	POLEA	
		38226	TENSOR	
		38226	TENSOR PARA BANDA MICRO-V	
4 CIL. 2.3 L	2006	36079	POLEA	
		38226	TENSOR	
		38226	TENSOR PARA BANDA MICRO-V	
		38226	TENSOR PARA BANDA MICRO-V	
4 CIL. 2.3 L	2005	36079	POLEA	
		38226	TENSOR	
		38226	TENSOR PARA BANDA MICRO-V	
		38226	TENSOR PARA BANDA MICRO-V	
4 CIL. 2.3 L	2004	36079	POLEA	
		38226	TENSOR	
		38226	TENSOR PARA BANDA MICRO-V	
		38226	TENSOR PARA BANDA MICRO-V	
4 CIL. 2.3 L	2003	38226	TENSOR	
		38226	TENSOR PARA BANDA MICRO-V	
V6, 3.0 L	2003	TCK285	KIT DE DISTRIBUCION	
		TCK285	KIT DE DISTRIBUCION	
		TCK285	KIT DE DISTRIBUCION	
		38009	POLEA	
		36079	POLEA	
		38009	TENSOR	
		38009	TENSOR	
		38179	TENSOR	
		38226	TENSOR	
		38179	TENSOR PARA BANDA MICRO-V	
		T41243	TENSOR- POLEA DE DIST.	
		T42086	TENSOR- POLEA DE DIST.	POLEA TENSORA
4 CIL. 2.3 L	2002	36079	POLEA	
		38226	TENSOR	
		38226	TENSOR	
		38226	TENSOR PARA BANDA MICRO-V	
		38226	TENSOR PARA BANDA MICRO-V	
V6, 3.0 L	2002	TCK285	KIT DE DISTRIBUCION	
		TCK285	KIT DE DISTRIBUCION	
		38009	POLEA	
		38179	TENSOR	

**9000**

4 CIL. 2.3 L	1998	38077	POLEA	POLEA LOCA
		38074	POLEA	DEL TENSOR
4 CIL. 2.3 L	1997	38074	POLEA	DEL TENSOR
		38077	POLEA	POLEA LOCA
V6, 3.0 L	1997	38081	POLEA	POLEA LOCA
4 CIL. 2.3 L	1996	38074	POLEA	DEL TENSOR
		38077	POLEA	POLEA LOCA
V6, 3.0 L	1996	38081	POLEA	POLEA LOCA
4 CIL. 2.3 L	1995	38074	POLEA	DEL TENSOR
		38077	POLEA	POLEA LOCA
V6, 3.0 L	1995	38081	POLEA	POLEA LOCA
4 CIL. 2.3 L	1994	38077	POLEA	POLEA LOCA
		38074	POLEA	DEL TENSOR
4 CIL. 2.3 L	1993	38077	POLEA	POLEA LOCA
		38074	POLEA	DEL TENSOR
4 CIL. 2.3 L	1992	38074	POLEA	DEL TENSOR
		38077	POLEA	POLEA LOCA
4 CIL. 2.3 L	1991	38074	POLEA	DEL TENSOR
		38077	POLEA	POLEA LOCA
4 CIL. 2.0 L	1990	38077	POLEA	DEL TENSOR Ait.
4 CIL. 2.3 L	1990	38074	POLEA	DEL TENSOR
		38077	POLEA	POLEA LOCA
4 CIL. 2.0 L	1989	38077	POLEA	DEL TENSOR Ait.
4 CIL. 2.0 L	1988	38077	POLEA	DEL TENSOR Ait.
4 CIL. 2.0 L	1987	38077	POLEA	DEL TENSOR Ait.
4 CIL. 2.0 L	1986	38077	POLEA	DEL TENSOR Ait.

**SATURN**

**AURA**

V6, 3.5 L	2007	38006	POLEA	INFERIOR
		38009	POLEA	CON CANALES

**ION**

4 CIL. 2.2 L	2007	38011	POLEA	
		38177	TENSOR PARA BANDA MICRO-V	
4 CIL. 2.4 L	2007	38011	POLEA	
		38177	TENSOR PARA BANDA MICRO-V	

4 CIL. 2.2 L	2006	38011	POLEA	
		38177	TENSOR PARA BANDA MICRO-V	
4 CIL. 2.4 L	2006	38011	POLEA	
		38177	TENSOR PARA BANDA MICRO-V	
4 CIL. 2.2 L	2005	38011	POLEA	
		38177	TENSOR PARA BANDA MICRO-V	
4 CIL. 2.2 L	2004	38011	POLEA	
		38177	TENSOR PARA BANDA MICRO-V	
4 CIL. 2.2 L	2003	38011	POLEA	
		38177	TENSOR PARA BANDA MICRO-V	

		T43016	TENSOR- POLEA DE DIST.	
		T43017	TENSOR- POLEA DE DIST.	CON TORNILLO
		T43017	TENSOR- POLEA DE DIST.	CON TORNILLO
4 CIL. 1.8 L	2006	38148	TENSOR	
		T43017	TENSOR- POLEA DE DIST.	CON TORNILLO
		T43016	TENSOR- POLEA DE DIST.	
4 CIL. 1.8 L	2005	38148	TENSOR	
		T43016	TENSOR- POLEA DE DIST.	
		T43017	TENSOR- POLEA DE DIST.	CON TORNILLO
4 CIL. 1.8 L	2004	38148	TENSOR	
		T43017	TENSOR- POLEA DE DIST.	CON TORNILLO
		T43016	TENSOR- POLEA DE DIST.	
4 CIL. 1.8 L	2003	38148	TENSOR	
		T43017	TENSOR- POLEA DE DIST.	CON TORNILLO
		T43016	TENSOR- POLEA DE DIST.	

**L-SERIES**

V6. 3.0 L	2005	T41243	TENSOR- POLEA DE DIST.	
		T42086	TENSOR- POLEA DE DIST.	POLEA TENSORA
V6. 3.0 L	2004	T41243	TENSOR- POLEA DE DIST.	
		T42086	TENSOR- POLEA DE DIST.	POLEA TENSORA
V6. 3.0 L	2003	T42086	TENSOR- POLEA DE DIST.	POLEA TENSORA
		T41243	TENSOR- POLEA DE DIST.	
V6. 3.0 L	2002	T42086	TENSOR- POLEA DE DIST.	POLEA TENSORA
		T41243	TENSOR- POLEA DE DIST.	
V6. 3.0 L	2001	T42086	TENSOR- POLEA DE DIST.	POLEA TENSORA
V6. 3.0 L	2000	T42086	TENSOR- POLEA DE DIST.	POLEA TENSORA

**ALTEA**

4 CIL. 2.0 L	2008	T42019	TENSOR- POLEA DE DIST.	
		T43142	TENSOR- POLEA DE DIST.	
		T43142	TENSOR- POLEA DE DIST.	
		T42019	TENSOR- POLEA DE DIST.	
4 CIL. 2.0 L	2007	T43142	TENSOR- POLEA DE DIST.	
		T42019	TENSOR- POLEA DE DIST.	
4 CIL. 2.0 L	2006	T43142	TENSOR- POLEA DE DIST.	
		T42019	TENSOR- POLEA DE DIST.	

**RELAY**

V6. 3.9 L	2007	38009	POLEA	CON CANALES
		38006	POLEA	LISO
V6. 3.5 L	2006	38009	POLEA	
		38043	POLEA	
		38104	TENSOR PARA BANDA MICRO-V	
V6. 3.9 L	2006	38009	POLEA	
		38006	POLEA	LISO
V6. 3.5 L	2005	38043	POLEA	
		38009	POLEA	
		38104	TENSOR PARA BANDA MICRO-V	

**CORDOBA**

4 CIL. 1.6 L	2008	TCK1548	KIT DE DISTRIBUCION	
		TPG-23001	TENSOR ARBOL DE LEVAS	
		TMV-23001	TENSOR MICRO-V	
4 CIL. 1.6 L	2007	TCK1548	KIT DE DISTRIBUCION	
		TPG-23001	TENSOR ARBOL DE LEVAS	
		TMV-23001	TENSOR MICRO-V	
		TMV-23001	TENSOR MICRO-V	
4 CIL. 2.0 L	2007	TCK296	KIT DE DISTRIBUCION	
		38148	TENSOR	
		T43010	TENSOR- POLEA DE DIST.	
4 CIL. 1.6 L	2006	TCK1548	KIT DE DISTRIBUCION	
		TPG-23001	TENSOR ARBOL DE LEVAS	
		TMV-23001	TENSOR MICRO-V	
4 CIL. 2.0 L	2006	TCK296	KIT DE DISTRIBUCION	
		38148	TENSOR	
		T43010	TENSOR- POLEA DE DIST.	
4 CIL. 1.6 L	2005	TCK1548	KIT DE DISTRIBUCION	
		TPG-23001	TENSOR ARBOL DE LEVAS	
		TMV-23001	TENSOR MICRO-V	
4 CIL. 2.0 L	2005	TCK296	KIT DE DISTRIBUCION	
		38148	TENSOR	
		T43010	TENSOR- POLEA DE DIST.	
4 CIL. 1.6 L	2004	TCK1548	KIT DE DISTRIBUCION	
		TPG-23001	TENSOR ARBOL DE LEVAS	
		TMV-23001	TENSOR MICRO-V	
4 CIL. 2.0 L	2004	TCK296	KIT DE DISTRIBUCION	
		38148	TENSOR	
		T43010	TENSOR- POLEA DE DIST.	
4 CIL. 1.6 L	2003	TCK1548	KIT DE DISTRIBUCION	
		TPG-23001	TENSOR ARBOL DE LEVAS	
		TMV-23001	TENSOR MICRO-V	
4 CIL. 2.0 L	2003	TCK296	KIT DE DISTRIBUCION	
		38148	TENSOR	
		T43010	TENSOR- POLEA DE DIST.	

**SKY**

4 CIL. 2.4 L	2007	38011	POLEA	ALT. Y.A.A.
		38177	TENSOR PARA BANDA MICRO-V	ALT. Y.A.A.

**S-SERIES**

4 CIL. 1.9 L	2002	38112	TENSOR PARA BANDA MICRO-V	
--------------	------	-------	---------------------------	--

**VUE**

V6. 3.5 L	2007	TCKWP329	KIT DE DISTRIBUCION CON B.A.	
		38341	TENSOR PARA BANDA MICRO-V	
		T43129	TENSOR- POLEA DE DIST.	HIDRAULICO
		T41231	TENSOR- POLEA DE DIST.	POLEA
V6. 3.5 L	2006	TCKWP329	KIT DE DISTRIBUCION CON B.A.	
		T41231	TENSOR- POLEA DE DIST.	POLEA
		T43129	TENSOR- POLEA DE DIST.	HIDRAULICO
V6. 3.5 L	2005	TCKWP329	KIT DE DISTRIBUCION CON B.A.	
		T41231	TENSOR- POLEA DE DIST.	POLEA
		T43129	TENSOR- POLEA DE DIST.	HIDRAULICO
V6. 3.5 L	2004	TCKWP329	KIT DE DISTRIBUCION CON B.A.	
		T43129	TENSOR- POLEA DE DIST.	HIDRAULICO
		T41231	TENSOR- POLEA DE DIST.	POLEA
V6. 3.0 L	2003	T42086	TENSOR- POLEA DE DIST.	POLEA TENSORA
		T41243	TENSOR- POLEA DE DIST.	
V6. 3.0 L	2002	T41243	TENSOR- POLEA DE DIST.	
		T42086	TENSOR- POLEA DE DIST.	POLEA TENSORA

**SEAT**

**ALHAMBRA**

4 CIL. 1.8 L	2007	38148	TENSOR	
		T43016	TENSOR- POLEA DE DIST.	

**IBIZA**

4 CIL. 1.6 L	2009	TCK1548	KIT DE DISTRIBUCION	
		TPG-23001	TENSOR ARBOL DE LEVAS	
		TMV-23001	TENSOR MICRO-V	
4 CIL. 2.0 L	2009	TCK296	KIT DE DISTRIBUCION	
		38148	TENSOR	
		T43010	TENSOR- POLEA DE DIST.	

4 CIL. 1.6 L		2008	TCK1548 TPG-23001 TMV-23001	KIT DE DISTRIBUCION TENSOR ARBOL DE LEVAS TENSOR MICRO-V	
4 CIL. 2.0 L		2008	TCK296 38148 T43010	KIT DE DISTRIBUCION TENSOR TENSOR- POLEA DE DIST.	
4 CIL. 1.6 L		2007	TCK1548 TPG-23001 TMV-23001	KIT DE DISTRIBUCION TENSOR ARBOL DE LEVAS TENSOR MICRO-V	
4 CIL. 2.0 L		2007	TCK296 38148 T43010	KIT DE DISTRIBUCION TENSOR TENSOR- POLEA DE DIST.	
4 CIL. 1.6 L		2006	TCK1548 TPG-23001 TMV-23001	KIT DE DISTRIBUCION TENSOR ARBOL DE LEVAS TENSOR MICRO-V	
4 CIL. 2.0 L		2006	TCK296 38148 T43010	KIT DE DISTRIBUCION TENSOR TENSOR- POLEA DE DIST.	
4 CIL. 1.6 L		2005	TCK1548 TPG-23001 TMV-23001	KIT DE DISTRIBUCION TENSOR ARBOL DE LEVAS TENSOR MICRO-V	
4 CIL. 2.0 L		2005	TCK296 38148 T43010	KIT DE DISTRIBUCION TENSOR TENSOR- POLEA DE DIST.	
4 CIL. 1.6 L		2004	TCK1548 TPG-23001 TMV-23001	KIT DE DISTRIBUCION TENSOR ARBOL DE LEVAS TENSOR MICRO-V	
4 CIL. 2.0 L		2004	TCK296 38148 T43010	KIT DE DISTRIBUCION TENSOR TENSOR- POLEA DE DIST.	
4 CIL. 1.6 L		2003	TCK1548 TPG-23001 TMV-23001	KIT DE DISTRIBUCION TENSOR ARBOL DE LEVAS TENSOR MICRO-V	
4 CIL. 2.0 L		2003	TCK296 38148 T43010	KIT DE DISTRIBUCION TENSOR TENSOR- POLEA DE DIST.	

**LEON**

4 CIL. 2.0 L		2007	T42019 T43142	TENSOR- POLEA DE DIST. TENSOR- POLEA DE DIST.	
4 CIL. 2.0 L		2006	T43142 T42019	TENSOR- POLEA DE DIST. TENSOR- POLEA DE DIST.	
4 CIL. 1.8 L		2005	38148 T43017	TENSOR TENSOR- POLEA DE DIST.	
4 CIL. 1.8 L		2004	38148 T43017	TENSOR TENSOR- POLEA DE DIST.	
4 CIL. 1.8 L		2003	38148 T43017	TENSOR TENSOR- POLEA DE DIST.	

**TOLEDO**

4 CIL. 2.0 L		2007	T42019 T43142	TENSOR- POLEA DE DIST. TENSOR- POLEA DE DIST.	
4 CIL. 2.0 L		2006	T43142 T42019	TENSOR- POLEA DE DIST. TENSOR- POLEA DE DIST.	
4 CIL. 1.8 L		2005	38148 T43017	TENSOR TENSOR- POLEA DE DIST.	
4 CIL. 1.8 L		2004	38148 T43017	TENSOR TENSOR- POLEA DE DIST.	
4 CIL. 1.8 L		2003	38148 T43017	TENSOR TENSOR- POLEA DE DIST.	

**SUBARU****BAJA**

4 CIL. 2.5 L		2006	T41226 T43138 T42146 T41239	TENSOR- POLEA DE DIST. TENSOR- POLEA DE DIST. TENSOR- POLEA DE DIST. TENSOR- POLEA DE DIST.	POLEA TENSORAIZQ HIDRAULICO POLEA POLEA TENSORA DER.
--------------	--	------	--------------------------------------	--	---

		2005	T42146 T41239 T41226 T43138	TENSOR- POLEA DE DIST. TENSOR- POLEA DE DIST. TENSOR- POLEA DE DIST. TENSOR- POLEA DE DIST.	POLEA POLEA TENSORA DER. POLEA TENSORAIZQ HIDRAULICO
4 CIL. 2.5 L		2004	T41239 T41226 T42146 T43138	TENSOR- POLEA DE DIST. TENSOR- POLEA DE DIST. TENSOR- POLEA DE DIST. TENSOR- POLEA DE DIST.	POLEA TENSORA DER. POLEA TENSORAIZQ POLEA HIDRAULICO
4 CIL. 2.5 L		2003	T41226 T42146 T43138	TENSOR- POLEA DE DIST. TENSOR- POLEA DE DIST. TENSOR- POLEA DE DIST.	POLEA TENSORAIZQ POLEA HIDRAULICO

**DL**

4 CIL. 1.8 L		1989	T41062 T42022 T41061	TENSOR- POLEA DE DIST. TENSOR- POLEA DE DIST. TENSOR- POLEA DE DIST.	IZQ. RODILLO DENTADA DERECHA
4 CIL. 1.8 L		1988	T41062 T42022 T41061	TENSOR- POLEA DE DIST. TENSOR- POLEA DE DIST. TENSOR- POLEA DE DIST.	IZQ. RODILLO DENTADA DERECHA
4 CIL. 1.8 L		1987	T42022 T41062 T41061	TENSOR- POLEA DE DIST. TENSOR- POLEA DE DIST. TENSOR- POLEA DE DIST.	RODILLO DENTADA DERECHA IZQ. DERECHA
4 CIL. 1.8 L		1986	T41062 T42022 T41061	TENSOR- POLEA DE DIST. TENSOR- POLEA DE DIST. TENSOR- POLEA DE DIST.	IZQ. RODILLO DENTADA DERECHA
4 CIL. 1.8 L		1985	T41062 T42022 T41061	TENSOR- POLEA DE DIST. TENSOR- POLEA DE DIST. TENSOR- POLEA DE DIST.	IZQ. RODILLO DENTADA DERECHA

**FORESTER**

4 CIL. 2.5 L		2007	38030 T41239 T41226 T43138	TENSOR TENSOR- POLEA DE DIST. TENSOR- POLEA DE DIST. TENSOR- POLEA DE DIST.	A.A. POLEA TENSORA DER. POLEA TENSORA IZQ SUP HIDRAULICO
4 CIL. 2.5 L		2006	T42146 38030 T41226 T42146 T43138 T41239 T42024 T42024 T42023 T42023	TENSOR- POLEA DE DIST. TENSOR TENSOR- POLEA DE DIST. TENSOR- POLEA DE DIST. TENSOR- POLEA DE DIST. TENSOR- POLEA DE DIST. TENSOR- POLEA DE DIST. TENSOR- POLEA DE DIST. TENSOR- POLEA DE DIST. TENSOR- POLEA DE DIST.	POLEA A.A. POLEA TENSORA IZQ SUP POLEA HIDRAULICO POLEA TENSORA DER.
4 CIL. 2.5 L		2005	T42146 T43138 T41226 T41239	TENSOR- POLEA DE DIST. TENSOR- POLEA DE DIST. TENSOR- POLEA DE DIST. TENSOR- POLEA DE DIST.	INF. MANO IZQ. INF. MANO IZQ. POLEA HIDRAULICO POLEA TENSORA IZQ SUP POLEA TENSORA DER.
4 CIL. 2.5 L		2004	T41239 T41226 T42146 T43138	TENSOR- POLEA DE DIST. TENSOR- POLEA DE DIST. TENSOR- POLEA DE DIST. TENSOR- POLEA DE DIST.	POLEA TENSORA DER. POLEA TENSORA IZQ SUP POLEA HIDRAULICO
4 CIL. 2.5 L		2003	T42146 T41226 T43138	TENSOR- POLEA DE DIST. TENSOR- POLEA DE DIST. TENSOR- POLEA DE DIST.	POLEA HIDRAULICO POLEA TENSORA IZQ SUP HIDRAULICO
4 CIL. 2.5 L		2002	T43138 T41226 T42146	TENSOR- POLEA DE DIST. TENSOR- POLEA DE DIST. TENSOR- POLEA DE DIST.	HIDRAULICO POLEA TENSORAIZQ POLEA
4 CIL. 2.5 L		2001	T41226 T43138 T42146 T41226	TENSOR- POLEA DE DIST. TENSOR- POLEA DE DIST. TENSOR- POLEA DE DIST. TENSOR- POLEA DE DIST.	POLEA TENSORAIZQ HIDRAULICO POLEA TENSORAIZQ HIDRAULICO
4 CIL. 2.5 L		2000	T42146 T41226 T43138	TENSOR- POLEA DE DIST. TENSOR- POLEA DE DIST. TENSOR- POLEA DE DIST.	POLEA POLEA TENSORAIZQ HIDRAULICO
4 CIL. 2.5 L		1999	T41226 T43138 T42146	TENSOR- POLEA DE DIST. TENSOR- POLEA DE DIST. TENSOR- POLEA DE DIST.	POLEA TENSORAIZQ HIDRAULICO POLEA
4 CIL. 2.5 L		1998	T42146 T43138	TENSOR- POLEA DE DIST. TENSOR- POLEA DE DIST.	POLEA HIDRAULICO

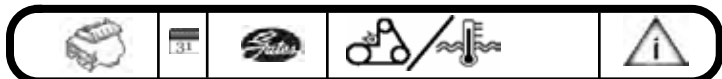

<b>GL</b>			
4 CIL. 1.8 L	1989	T42022	TENSOR- POLEA DE DIST.
		T41062	TENSOR- POLEA DE DIST.
		T41061	TENSOR- POLEA DE DIST.
4 CIL. 1.8 L	1988	T41062	TENSOR- POLEA DE DIST.
		T41061	TENSOR- POLEA DE DIST.
		T42022	TENSOR- POLEA DE DIST.
4 CIL. 1.8 L	1987	T42022	TENSOR- POLEA DE DIST.
		T41062	TENSOR- POLEA DE DIST.
		T41061	TENSOR- POLEA DE DIST.
4 CIL. 1.8 L	1986	T41062	TENSOR- POLEA DE DIST.
		T42022	TENSOR- POLEA DE DIST.
		T41061	TENSOR- POLEA DE DIST.
4 CIL. 1.8 L	1985	T41061	TENSOR- POLEA DE DIST.
		T41062	TENSOR- POLEA DE DIST.
		T42022	TENSOR- POLEA DE DIST.

<b>GL-10</b>			
4 CIL. 1.8 L	1989	T42022	TENSOR- POLEA DE DIST.
		T41061	TENSOR- POLEA DE DIST.
		T41062	TENSOR- POLEA DE DIST.
4 CIL. 1.8 L	1988	T42022	TENSOR- POLEA DE DIST.
		T41062	TENSOR- POLEA DE DIST.
		T41061	TENSOR- POLEA DE DIST.
4 CIL. 1.8 L	1987	T41061	TENSOR- POLEA DE DIST.
		T41062	TENSOR- POLEA DE DIST.
		T42022	TENSOR- POLEA DE DIST.
4 CIL. 1.8 L	1986	T41061	TENSOR- POLEA DE DIST.
		T42022	TENSOR- POLEA DE DIST.
		T41062	TENSOR- POLEA DE DIST.
4 CIL. 1.8 L	1985	T41061	TENSOR- POLEA DE DIST.
		T41062	TENSOR- POLEA DE DIST.
		T42022	TENSOR- POLEA DE DIST.

<b>IMPREZA</b>			
4 CIL. 2.5 L	2007	38030	TENSOR
		T42146	TENSOR- POLEA DE DIST.
		T41239	TENSOR- POLEA DE DIST.
		T43138	TENSOR- POLEA DE DIST.
		T41226	TENSOR- POLEA DE DIST.
4 CIL. 2.5 L	2006	38030	TENSOR
		T42023	TENSOR- POLEA DE DIST.
		T42024	TENSOR- POLEA DE DIST.
		T43138	TENSOR- POLEA DE DIST.
		T41226	TENSOR- POLEA DE DIST.
		T41239	TENSOR- POLEA DE DIST.
		T42146	TENSOR- POLEA DE DIST.
4 CIL. 2.0 L	2005	T42146	TENSOR- POLEA DE DIST.
		T43138	TENSOR- POLEA DE DIST.
		T41239	TENSOR- POLEA DE DIST.
4 CIL. 2.5 L	2005	T41239	TENSOR- POLEA DE DIST.
		T42146	TENSOR- POLEA DE DIST.
		T41226	TENSOR- POLEA DE DIST.
		T43138	TENSOR- POLEA DE DIST.
4 CIL. 2.0 L	2004	T41239	TENSOR- POLEA DE DIST.
		T43138	TENSOR- POLEA DE DIST.
		T42146	TENSOR- POLEA DE DIST.
4 CIL. 2.5 L	2004	T43138	TENSOR- POLEA DE DIST.
		T42146	TENSOR- POLEA DE DIST.
		T41239	TENSOR- POLEA DE DIST.
		T41226	TENSOR- POLEA DE DIST.
4 CIL. 2.0 L	2003	T42146	TENSOR- POLEA DE DIST.
		T41225	TENSOR- POLEA DE DIST.
		T43138	TENSOR- POLEA DE DIST.
4 CIL. 2.5 L	2003	T42146	TENSOR- POLEA DE DIST.
		T41226	TENSOR- POLEA DE DIST.
		T43138	TENSOR- POLEA DE DIST.
4 CIL. 2.0 L	2002	T43138	TENSOR- POLEA DE DIST.
		T41225	TENSOR- POLEA DE DIST.

4 CIL. 2.5 L	2002	T42146	TENSOR- POLEA DE DIST.
		T41226	TENSOR- POLEA DE DIST.
		T43138	TENSOR- POLEA DE DIST.
4 CIL. 2.2 L	2001	T42146	TENSOR- POLEA DE DIST.
		T41226	TENSOR- POLEA DE DIST.
		T43138	TENSOR- POLEA DE DIST.
4 CIL. 2.5 L	2001	T43138	TENSOR- POLEA DE DIST.
		T41226	TENSOR- POLEA DE DIST.
		T42146	TENSOR- POLEA DE DIST.
4 CIL. 2.2 L	2000	T43138	TENSOR- POLEA DE DIST.
		T41226	TENSOR- POLEA DE DIST.
		T42146	TENSOR- POLEA DE DIST.
4 CIL. 2.5 L	2000	T43138	TENSOR- POLEA DE DIST.
		T42146	TENSOR- POLEA DE DIST.
		T41226	TENSOR- POLEA DE DIST.
4 CIL. 2.2 L	1999	T42146	TENSOR- POLEA DE DIST.
		T41226	TENSOR- POLEA DE DIST.
		T43138	TENSOR- POLEA DE DIST.
4 CIL. 2.5 L	1999	T42146	TENSOR- POLEA DE DIST.
		T43138	TENSOR- POLEA DE DIST.
		T41226	TENSOR- POLEA DE DIST.
4 CIL. 2.2 L	1998	T43138	TENSOR- POLEA DE DIST.
		T42146	TENSOR- POLEA DE DIST.
4 CIL. 2.5 L	1998	T43138	TENSOR- POLEA DE DIST.
		T42146	TENSOR- POLEA DE DIST.
4 CIL. 1.8 L	1997	T41063	TENSOR- POLEA DE DIST.
		T41063	TENSOR- POLEA DE DIST.
4 CIL. 2.2 L	1997	T43138	TENSOR- POLEA DE DIST.
		T42146	TENSOR- POLEA DE DIST.
4 CIL. 1.8 L	1996	T41063	TENSOR- POLEA DE DIST.
		T41063	TENSOR- POLEA DE DIST.
4 CIL. 2.2 L	1996	T41063	TENSOR- POLEA DE DIST.
		T41063	TENSOR- POLEA DE DIST.
4 CIL. 1.8 L	1995	T41063	TENSOR- POLEA DE DIST.
		T41063	TENSOR- POLEA DE DIST.
4 CIL. 2.2 L	1995	T41063	TENSOR- POLEA DE DIST.
		T41063	TENSOR- POLEA DE DIST.
4 CIL. 1.8 L	1994	T41063	TENSOR- POLEA DE DIST.
		T41063	TENSOR- POLEA DE DIST.
4 CIL. 1.8 L	1993	T41063	TENSOR- POLEA DE DIST.
		T41063	TENSOR- POLEA DE DIST.

<b>JUSTY</b>			
3 CIL. 1.2 L (Canada)	1995	T41060	TENSOR- POLEA DE DIST.
3 CIL. 1.2 L	1994	T41060	TENSOR- POLEA DE DIST.
3 CIL. 1.2 L	1993	T41060	TENSOR- POLEA DE DIST.
3 CIL. 1.2 L	1992	T41060	TENSOR- POLEA DE DIST.
3 CIL. 1.2 L	1991	T41060	TENSOR- POLEA DE DIST.
3 CIL. 1.2 L	1990	T41060	TENSOR- POLEA DE DIST.
3 CIL. 1.2 L	1989	T41060	TENSOR- POLEA DE DIST.
3 CIL. 1.2 L	1988	T41060	TENSOR- POLEA DE DIST.
3 CIL. 1.2 L	1987	T41060	TENSOR- POLEA DE DIST.

<b>LEGACY</b>			
4 CIL. 2.5 L	2007	38030	TENSOR
		T43138	TENSOR- POLEA DE DIST.
		T41239	TENSOR- POLEA DE DIST.
		T41226	TENSOR- POLEA DE DIST.
		T42146	TENSOR- POLEA DE DIST.
4 CIL. 2.5 L	2006	38030	TENSOR
		T42024	TENSOR- POLEA DE DIST.
		T42146	TENSOR- POLEA DE DIST.
		T41239	TENSOR- POLEA DE DIST.
		T41226	TENSOR- POLEA DE DIST.
		T42023	TENSOR- POLEA DE DIST.
		T43138	TENSOR- POLEA DE DIST.
4 CIL. 2.5 L	2005	T42146	TENSOR- POLEA DE DIST.
		T43138	TENSOR- POLEA DE DIST.
		T41226	TENSOR- POLEA DE DIST.
		T41239	TENSOR- POLEA DE DIST.

4 CIL. 2.5 L	2004	T42146	SENSOR- POLEA DE DIST.	POLEA
		T41226	SENSOR- POLEA DE DIST.	POLEA TENSORAIZQ
		T43138	SENSOR- POLEA DE DIST.	HIDRAULICO
4 CIL. 2.5 L	2003	T41226	SENSOR- POLEA DE DIST.	POLEA TENSORAIZQ
		T42146	SENSOR- POLEA DE DIST.	POLEA
		T43138	SENSOR- POLEA DE DIST.	HIDRAULICO
4 CIL. 2.5 L	2002	T42146	SENSOR- POLEA DE DIST.	POLEA
		T43138	SENSOR- POLEA DE DIST.	HIDRAULICO
		T41226	SENSOR- POLEA DE DIST.	POLEA TENSORAIZQ
4 CIL. 2.5 L	2001	T43138	SENSOR- POLEA DE DIST.	HIDRAULICO
		T41226	SENSOR- POLEA DE DIST.	POLEA TENSORAIZQ
		T42146	SENSOR- POLEA DE DIST.	POLEA
4 CIL. 2.5 L	2000	T41226	SENSOR- POLEA DE DIST.	POLEA TENSORAIZQ
		T43138	SENSOR- POLEA DE DIST.	HIDRAULICO
		T42146	SENSOR- POLEA DE DIST.	POLEA
4 CIL. 2.2 L	1999	T41226	SENSOR- POLEA DE DIST.	POLEA TENSORAIZQ
		T42146	SENSOR- POLEA DE DIST.	POLEA
		T43138	SENSOR- POLEA DE DIST.	HIDRAULICO
4 CIL. 2.5 L	1999	T42146	SENSOR- POLEA DE DIST.	POLEA
		T43138	SENSOR- POLEA DE DIST.	HIDRAULICO
4 CIL. 2.2 L	1998	T43138	SENSOR- POLEA DE DIST.	HIDRAULICO
		T42146	SENSOR- POLEA DE DIST.	POLEA
4 CIL. 2.5 L	1998	T42146	SENSOR- POLEA DE DIST.	POLEA
		T43138	SENSOR- POLEA DE DIST.	HIDRAULICO
4 CIL. 2.5 L	1997	T42146	SENSOR- POLEA DE DIST.	POLEA
		T43138	SENSOR- POLEA DE DIST.	HIDRAULICO
4 CIL. 2.2 L	1996	T41063	SENSOR- POLEA DE DIST.	(DEL TENSOR)
		T41063	SENSOR- POLEA DE DIST.	POLEA
4 CIL. 2.5 L	1996	T41092	SENSOR- POLEA DE DIST.	(DEL TENSOR)
		T41092	SENSOR- POLEA DE DIST.	POLEA
4 CIL. 2.2 L	1995	T41063	SENSOR- POLEA DE DIST.	(DEL TENSOR)
		T41063	SENSOR- POLEA DE DIST.	POLEA
4 CIL. 2.2 L	1994	T41063	SENSOR- POLEA DE DIST.	(DEL TENSOR)
		T41063	SENSOR- POLEA DE DIST.	POLEA
4 CIL. 2.2 L	1993	TCKWP172	KIT DE DISTRIBUCION CON B.A.	(DEL TENSOR)
		T41063	SENSOR- POLEA DE DIST.	POLEA
		T41063	SENSOR- POLEA DE DIST.	POLEA
4 CIL. 2.2 L	1992	TCKWP172	KIT DE DISTRIBUCION CON B.A.	(DEL TENSOR)
		T41063	SENSOR- POLEA DE DIST.	POLEA
		T41063	SENSOR- POLEA DE DIST.	POLEA
4 CIL. 2.2 L	1991	TCKWP172	KIT DE DISTRIBUCION CON B.A.	(DEL TENSOR)
		T41063	SENSOR- POLEA DE DIST.	POLEA
4 CIL. 2.2 L	1990	TCKWP172	KIT DE DISTRIBUCION CON B.A.	(DEL TENSOR)
		T41063	SENSOR- POLEA DE DIST.	POLEA

		T42146	SENSOR- POLEA DE DIST.	POLEA
		T41226	SENSOR- POLEA DE DIST.	POLEA TENSORA IZQ SUP
		T41239	SENSOR- POLEA DE DIST.	POLEA TENSORA DER.
4 CIL. 2.5 L	2005	T43138	SENSOR- POLEA DE DIST.	HIDRAULICO
		T41226	SENSOR- POLEA DE DIST.	POLEA TENSORAIZQ
		T41226	SENSOR- POLEA DE DIST.	POLEA TENSORA IZQ SUP
		T41239	SENSOR- POLEA DE DIST.	POLEA TENSORA DER.
		T42146	SENSOR- POLEA DE DIST.	POLEA
4 CIL. 2.5 L	2004	T41226	SENSOR- POLEA DE DIST.	POLEA TENSORAIZQ
		T42146	SENSOR- POLEA DE DIST.	POLEA
		T41226	SENSOR- POLEA DE DIST.	POLEA TENSORA IZQ SUP
		T43138	SENSOR- POLEA DE DIST.	HIDRAULICO
4 CIL. 2.5 L	2003	T41226	SENSOR- POLEA DE DIST.	POLEA TENSORA IZQ SUP
		T43138	SENSOR- POLEA DE DIST.	HIDRAULICO
		T42146	SENSOR- POLEA DE DIST.	POLEA
		T41226	SENSOR- POLEA DE DIST.	POLEA TENSORAIZQ
4 CIL. 2.5 L	2002	T43138	SENSOR- POLEA DE DIST.	HIDRAULICO
		T41226	SENSOR- POLEA DE DIST.	POLEA TENSORAIZQ
		T41226	SENSOR- POLEA DE DIST.	POLEA TENSORA IZQ SUP
		T42146	SENSOR- POLEA DE DIST.	POLEA
4 CIL. 2.5 L	2001	T41226	SENSOR- POLEA DE DIST.	POLEA TENSORAIZQ
		T42146	SENSOR- POLEA DE DIST.	POLEA
4 CIL. 2.5 L	2000	T43138	SENSOR- POLEA DE DIST.	HIDRAULICO
		T41226	SENSOR- POLEA DE DIST.	POLEA TENSORAIZQ
		T43138	SENSOR- POLEA DE DIST.	HIDRAULICO
		T42146	SENSOR- POLEA DE DIST.	POLEA

**RX**

4 CIL. 1.8 L	1989	T41061	SENSOR- POLEA DE DIST.	DERECHA
		T42022	SENSOR- POLEA DE DIST.	RODILLO DENTADA
		T41062	SENSOR- POLEA DE DIST.	IZQ.
4 CIL. 1.8 L	1988	T41062	SENSOR- POLEA DE DIST.	DERECHA
		T41061	SENSOR- POLEA DE DIST.	RODILLO DENTADA
		T42022	SENSOR- POLEA DE DIST.	IZQ.
4 CIL. 1.8 L	1987	T41062	SENSOR- POLEA DE DIST.	DERECHA
		T41061	SENSOR- POLEA DE DIST.	RODILLO DENTADA
		T42022	SENSOR- POLEA DE DIST.	IZQ.
4 CIL. 1.8 L	1986	T41062	SENSOR- POLEA DE DIST.	DERECHA
		T42022	SENSOR- POLEA DE DIST.	RODILLO DENTADA
		T41061	SENSOR- POLEA DE DIST.	DERECHA
4 CIL. 1.8 L	1985	T42022	SENSOR- POLEA DE DIST.	RODILLO DENTADA
		T41062	SENSOR- POLEA DE DIST.	IZQ.
		T41061	SENSOR- POLEA DE DIST.	DERECHA

**LOYALE**

4 CIL. 1.8 L	1994	T41062	SENSOR- POLEA DE DIST.	IZQ.
		T41061	SENSOR- POLEA DE DIST.	DERECHA
		T42022	SENSOR- POLEA DE DIST.	RODILLO DENTADA
4 CIL. 1.8 L	1993	T41061	SENSOR- POLEA DE DIST.	DERECHA
		T41062	SENSOR- POLEA DE DIST.	IZQ.
		T42022	SENSOR- POLEA DE DIST.	RODILLO DENTADA
4 CIL. 1.8 L	1992	T41062	SENSOR- POLEA DE DIST.	IZQ.
		T42022	SENSOR- POLEA DE DIST.	RODILLO DENTADA
		T41061	SENSOR- POLEA DE DIST.	DERECHA
4 CIL. 1.8 L	1991	T42022	SENSOR- POLEA DE DIST.	RODILLO DENTADA
		T41062	SENSOR- POLEA DE DIST.	IZQ.
		T41061	SENSOR- POLEA DE DIST.	DERECHA
4 CIL. 1.8 L	1990	T41062	SENSOR- POLEA DE DIST.	IZQ.
		T41061	SENSOR- POLEA DE DIST.	DERECHA
		T42022	SENSOR- POLEA DE DIST.	RODILLO DENTADA

**SVX**

6 CIL. 3.3 L	1997	T42118	SENSOR- POLEA DE DIST.	POLEA LOCA
		T42119	SENSOR- POLEA DE DIST.	RODILLO DENTADA
		T41213	SENSOR- POLEA DE DIST.	(DEL TENSOR)
6 CIL. 3.3 L	1996	T42118	SENSOR- POLEA DE DIST.	POLEA LOCA
6 CIL. 3.3 L	1995	T42118	SENSOR- POLEA DE DIST.	POLEA LOCA
		T41213	SENSOR- POLEA DE DIST.	(DEL TENSOR)
		T42119	SENSOR- POLEA DE DIST.	RODILLO DENTADA
6 CIL. 3.3 L	1994	T42118	SENSOR- POLEA DE DIST.	POLEA LOCA
		T42119	SENSOR- POLEA DE DIST.	RODILLO DENTADA
		T41213	SENSOR- POLEA DE DIST.	(DEL TENSOR)
6 CIL. 3.3 L	1993	T41213	SENSOR- POLEA DE DIST.	(DEL TENSOR)
		T42118	SENSOR- POLEA DE DIST.	POLEA LOCA
		T42119	SENSOR- POLEA DE DIST.	RODILLO DENTADA
6 CIL. 3.3 L	1992	T42118	SENSOR- POLEA DE DIST.	POLEA LOCA
		T42119	SENSOR- POLEA DE DIST.	RODILLO DENTADA
		T41213	SENSOR- POLEA DE DIST.	(DEL TENSOR)

**OUTBACK**

4 CIL. 2.5 L	2007	T41226	SENSOR- POLEA DE DIST.	POLEA TENSORAIZQ
		T43138	SENSOR- POLEA DE DIST.	HIDRAULICO
		T42146	SENSOR- POLEA DE DIST.	POLEA
4 CIL. 2.5 L	2006	38030	SENSOR	A.A.
		T43138	SENSOR- POLEA DE DIST.	HIDRAULICO
		T42023	SENSOR- POLEA DE DIST.	SUP. MANO IZQ.
		T42024	SENSOR- POLEA DE DIST.	POLEA TENSORAIZQ
		T41226	SENSOR- POLEA DE DIST.	POLEA TENSORAIZQ

**XT**

4 CIL. 1.8 L	1991	T42022	SENSOR- POLEA DE DIST.	RODILLO DENTADA
		T41061	SENSOR- POLEA DE DIST.	DERECHA
		T41062	SENSOR- POLEA DE DIST.	IZQ.
4 CIL. 1.8 L	1990	T41061	SENSOR- POLEA DE DIST.	DERECHA
		T41062	SENSOR- POLEA DE DIST.	IZQ.
		T42022	SENSOR- POLEA DE DIST.	RODILLO DENTADA
4 CIL. 1.8 L	1989	T41062	SENSOR- POLEA DE DIST.	IZQ.

4 CIL. 1.8 L	1989	T42022	TENSOR- POLEA DE DIST.	RODILLO DENTADA
		T41061	TENSOR- POLEA DE DIST.	DERECHA
4 CIL. 1.8 L	1988	T41062	TENSOR- POLEA DE DIST.	IZQ.
		T42022	TENSOR- POLEA DE DIST.	RODILLO DENTADA
		T41061	TENSOR- POLEA DE DIST.	DERECHA
4 CIL. 1.8 L	1987	T42022	TENSOR- POLEA DE DIST.	RODILLO DENTADA
		T41061	TENSOR- POLEA DE DIST.	DERECHA
		T41062	TENSOR- POLEA DE DIST.	IZQ.
4 CIL. 1.8 L	1986	T41061	TENSOR- POLEA DE DIST.	DERECHA
		T41062	TENSOR- POLEA DE DIST.	IZQ.
		T42022	TENSOR- POLEA DE DIST.	RODILLO DENTADA
4 CIL. 1.8 L	1985	T41061	TENSOR- POLEA DE DIST.	DERECHA
		T41062	TENSOR- POLEA DE DIST.	IZQ.
		T42022	TENSOR- POLEA DE DIST.	RODILLO DENTADA

<b>SX4</b>				
4 CIL. 2.0 L	2010	38156	TENSOR	
4 CIL. 2.0 L	2009	38156	TENSOR	
4 CIL. 2.0 L	2008	38156	TENSOR	
4 CIL. 2.0 L	2007	38156	TENSOR	

<b>VITARA</b>				
4 CIL. 1.6 L (Canada)	2002	T41065	TENSOR- POLEA DE DIST.	
4 CIL. 1.6 L	2001	T41065	TENSOR- POLEA DE DIST.	
4 CIL. 1.6 L	2000	T41065	TENSOR- POLEA DE DIST.	
4 CIL. 1.6 L	1999	T41065	TENSOR- POLEA DE DIST.	

<b>X-90</b>				
4 CIL. 1.6 L	1998	T41065	TENSOR- POLEA DE DIST.	
4 CIL. 1.6 L	1997	T41065	TENSOR- POLEA DE DIST.	
4 CIL. 1.6 L	1996	T41065	TENSOR- POLEA DE DIST.	

<b>XL-7</b>				
V6, 3.6 L	2009	38397	TENSOR	
V6, 3.6 L	2008	38397	TENSOR	
V6, 3.6 L	2007	38397	TENSOR	

**SUZUKI**

<b>AERIO</b>				
4 CIL. 2.3 L	2006	38156	TENSOR	
		38010	TENSOR	
4 CIL. 2.3 L	2005	38156	TENSOR	
		38010	TENSOR	

<b>FORENZA</b>				
4 CIL. 2.0 L	2007	38154	TENSOR PARA BANDA MICRO-V	
4 CIL. 2.0 L	2006	38154	TENSOR PARA BANDA MICRO-V	
4 CIL. 2.0 L	2005	38154	TENSOR PARA BANDA MICRO-V	
4 CIL. 2.0 L	2004	38154	TENSOR PARA BANDA MICRO-V	

<b>GRAND VITARA</b>				
V6, 3.2 L	2010	38397	TENSOR	
V6, 3.2 L	2009	38397	TENSOR	

<b>RENO</b>				
4 CIL. 2.0 L	2007	38154	TENSOR PARA BANDA MICRO-V	
4 CIL. 2.0 L	2006	38154	TENSOR PARA BANDA MICRO-V	
4 CIL. 2.0 L	2005	38154	TENSOR PARA BANDA MICRO-V	

<b>SIDEKICK</b>				
4 CIL. 1.6 L	1998	T41065	TENSOR- POLEA DE DIST.	
4 CIL. 1.6 L	1997	T41065	TENSOR- POLEA DE DIST.	
4 CIL. 1.6 L	1996	T41065	TENSOR- POLEA DE DIST.	
4 CIL. 1.6 L	1995	T41064	TENSOR- POLEA DE DIST.	
		T41065	TENSOR- POLEA DE DIST.	
4 CIL. 1.6 L	1994	T41064	TENSOR- POLEA DE DIST.	
		T41065	TENSOR- POLEA DE DIST.	
4 CIL. 1.6 L	1993	T41064	TENSOR- POLEA DE DIST.	
		T41065	TENSOR- POLEA DE DIST.	
4 CIL. 1.6 L	1992	T41064	TENSOR- POLEA DE DIST.	
		T41065	TENSOR- POLEA DE DIST.	

<b>SWIFT</b>				
4 CIL. 1.6 L	2008	TCK335	KIT DE DISTRIBUCION	
		38376	TENSOR	
		38024	TENSOR	
		38015	TENSOR	
		T42170	TENSOR- POLEA DE DIST.	
		T43039	TENSOR- POLEA DE DIST.	
4 CIL. 1.6 L	2007	38024	TENSOR	C/AA
		38015	TENSOR	
		38376	TENSOR	
4 CIL. 1.6 L	2006	38376	TENSOR	
		38024	TENSOR	C/AA
		38015	TENSOR	
3 CIL. 1.0 L (Canada)	1993	T41009	TENSOR- POLEA DE DIST.	
3 CIL. 1.0 L (Canada)	1992	T41009	TENSOR- POLEA DE DIST.	

**TOYOTA**

<b>4 RUNNER</b>				
V8, 4.7 L	2007	36026	POLEA	
		36119	POLEA	
		36119	POLEA	
		36026	POLEA	
		38173	TENSOR	
		38173	TENSOR PARA BANDA MICRO-V	
		T41078	TENSOR- POLEA DE DIST.	
		T41078	TENSOR- POLEA DE DIST.	
		T42031	TENSOR- POLEA DE DIST.	
		T42031	TENSOR- POLEA DE DIST.	
		T43097	TENSOR- POLEA DE DIST.	
		T43097	TENSOR- POLEA DE DIST.	
V8, 4.7 L	2006	36119	POLEA	
		36026	POLEA	
		38173	TENSOR	
		T41078	TENSOR- POLEA DE DIST.	
V8, 4.7 L	2005	36026	POLEA	
		36119	POLEA	
		38173	TENSOR	
		T42031	TENSOR- POLEA DE DIST.	
		T41078	TENSOR- POLEA DE DIST.	
		T43097	TENSOR- POLEA DE DIST.	
V8, 4.7 L	2004	36026	POLEA	
		36119	POLEA	
		38001	TENSOR	
		38173	TENSOR	
		T43097	TENSOR- POLEA DE DIST.	
		T41078	TENSOR- POLEA DE DIST.	
		T42031	TENSOR- POLEA DE DIST.	
V8, 4.7 L	2003	36026	POLEA	
		36119	POLEA	
		38173	TENSOR	
		38001	TENSOR	
		T43097	TENSOR- POLEA DE DIST.	
		T42031	TENSOR- POLEA DE DIST.	
		T41078	TENSOR- POLEA DE DIST.	
V6, 3.4 L	2002	TCK271	KIT DE DISTRIBUCION	
		38031	TENSOR	A.A.
		T41204	TENSOR- POLEA DE DIST.	
		T41204	TENSOR- POLEA DE DIST.	

4 CIL. 2.7 L V6, 3.0 L	2000 1995	38031 TCKWP240 T41073 T41203 T42037 T42037 T41203	POLEA KIT DE DISTRIBUCION CON B.A. TENSOR- POLEA DE DIST. TENSOR- POLEA DE DIST. TENSOR- POLEA DE DIST. TENSOR- POLEA DE DIST. TENSOR- POLEA DE DIST.	A.A.       	4 CIL. 2.4 L V6, 3.0 L	2005 2005	38216 T43098 T42030 T42030	TENSOR TENSOR- POLEA DE DIST. TENSOR- POLEA DE DIST. TENSOR- POLEA DE DIST.	     
V6, 3.0 L	1994	T42037 T41203 TCKWP240 T41073 T41203 T41203 T42037 T42037	TENSOR- POLEA DE DIST. TENSOR- POLEA DE DIST. KIT DE DISTRIBUCION CON B.A. TENSOR- POLEA DE DIST. TENSOR- POLEA DE DIST. TENSOR- POLEA DE DIST. TENSOR- POLEA DE DIST. TENSOR- POLEA DE DIST.	POLEA POLEA TENSORA POLEA LOCA (DEL TENSOR)     	V6, 3.3 L 4 CIL. 2.4 L V6, 3.0 L	2005 2004 2004	T42030 38216 T42030	TENSOR- POLEA DE DIST. TENSOR TENSOR- POLEA DE DIST. TENSOR- POLEA DE DIST. TENSOR- POLEA DE DIST. TENSOR- POLEA DE DIST. TENSOR	POLEA TENSORA POLEA TENSORA     
V6, 3.0 L	1993	T42037 TCKWP240 T41203 T42037 T41073 T41203 T42037	TENSOR- POLEA DE DIST. KIT DE DISTRIBUCION CON B.A. TENSOR- POLEA DE DIST. TENSOR- POLEA DE DIST. TENSOR- POLEA DE DIST. TENSOR- POLEA DE DIST. TENSOR- POLEA DE DIST.	POLEA (DEL TENSOR) POLEA TENSORA POLEA LOCA     	V6, 3.0 L	2004 2003	T42030 T42030	TENSOR- POLEA DE DIST. TENSOR- POLEA DE DIST. TENSOR- POLEA DE DIST. TENSOR	POLEA TENSORA     
V6, 3.0 L	1992	T42037 TCKWP240C T41073 T42037 T42037 T41203 T41073	TENSOR- POLEA DE DIST. KIT DE DISTRIBUCION CON B.A. TENSOR- POLEA DE DIST. TENSOR- POLEA DE DIST. TENSOR- POLEA DE DIST. TENSOR- POLEA DE DIST. TENSOR- POLEA DE DIST.	POLEA LOCA       	V6, 3.0 L	2002	TCK257 T42030	KIT DE DISTRIBUCION TENSOR- POLEA DE DIST.	     
V6, 3.0 L	1991	T42037 TCKWP240C T41073 T42037	TENSOR- POLEA DE DIST. KIT DE DISTRIBUCION CON B.A. TENSOR- POLEA DE DIST. TENSOR- POLEA DE DIST.	POLEA LOCA    	V6, 3.0 L	2001	T43098 T42030	TENSOR- POLEA DE DIST. TENSOR- POLEA DE DIST.	    
V6, 3.0 L	1990	T42037 TCKWP240C T41073 T42037	TENSOR- POLEA DE DIST. KIT DE DISTRIBUCION CON B.A. TENSOR- POLEA DE DIST. TENSOR- POLEA DE DIST.	POLEA LOCA    	V6, 3.0 L	2001	T43096 T43096 T41075 T42030 T41075	TENSOR- POLEA DE DIST. TENSOR- POLEA DE DIST. TENSOR- POLEA DE DIST. TENSOR- POLEA DE DIST. TENSOR- POLEA DE DIST.	     
V6, 3.0 L	1989	T42037 TCKWP240C T41073 T42037	TENSOR- POLEA DE DIST. KIT DE DISTRIBUCION CON B.A. TENSOR- POLEA DE DIST. TENSOR- POLEA DE DIST.	POLEA LOCA    	V6, 3.0 L	2001	T43096 T43096 T41075 T42030	TENSOR- POLEA DE DIST. TENSOR- POLEA DE DIST. TENSOR- POLEA DE DIST. TENSOR- POLEA DE DIST.	    
V6, 3.0 L	1988	T42037 TCKWP240C T41073 T42037	TENSOR- POLEA DE DIST. KIT DE DISTRIBUCION CON B.A. TENSOR- POLEA DE DIST. TENSOR- POLEA DE DIST.	POLEA LOCA    	4 CIL. 2.0 L 4 CIL. 2.2 L V6, 3.0 L	2000 2000 2000	TCKWP199 TCKWP199 T41075	KIT DE DISTRIBUCION CON B.A. KIT DE DISTRIBUCION CON B.A. TENSOR- POLEA DE DIST.	    
<b>AVALON</b>					V6, 3.0 L	2004	T42030 T43096 T41075	TENSOR- POLEA DE DIST. TENSOR- POLEA DE DIST. TENSOR- POLEA DE DIST.	
<b>CAMRY</b>					V6, 3.0 L	1999	TCKWP199	KIT DE DISTRIBUCION CON B.A.	
4 CIL. 2.5 L	2011	36156 38025 38018	POLEA TENSOR TENSOR		4 CIL. 2.0 L 4 CIL. 2.2 L V6, 3.0 L	1999	T41075 T42030 T43096	TENSOR- POLEA DE DIST. TENSOR- POLEA DE DIST. TENSOR- POLEA DE DIST.	POLEA POLEA TENSORA HIDRAULICO
V6, 3.5 L	2011	36173 37026P 38410	POLEA POLEA DECOPLADORA TENSOR		4 CIL. 2.0 L 4 CIL. 2.2 L V6, 3.0 L	1997	TCKWP199 TCKWP199 T41075	KIT DE DISTRIBUCION CON B.A. KIT DE DISTRIBUCION CON B.A. TENSOR- POLEA DE DIST.	POLEA POLEA TENSORA HIDRAULICO
4 CIL. 2.5 L	2010	36156 38018 38025	POLEA TENSOR TENSOR		4 CIL. 2.0 L 4 CIL. 2.2 L V6, 3.0 L	1996	T42030 TCKWP199 TCKWP199	TENSOR- POLEA DE DIST. KIT DE DISTRIBUCION CON B.A. KIT DE DISTRIBUCION CON B.A.	POLEA HIDRAULICO POLEA TENSORA
V6, 3.5 L	2010	36173 37026P 38410	POLEA POLEA DECOPLADORA TENSOR		4 CIL. 2.0 L 4 CIL. 2.2 L V6, 3.0 L	1996	T41075 T43096 T42030	TENSOR- POLEA DE DIST. TENSOR- POLEA DE DIST. TENSOR- POLEA DE DIST.	POLEA HIDRAULICO POLEA TENSORA
4 CIL. 2.4 L	2009	37017P 38453	POLEA DECOPLADORA TENSOR		4 CIL. 2.0 L 4 CIL. 2.2 L V6, 3.0 L	1995	TCKWP199 TCKWP199	KIT DE DISTRIBUCION CON B.A. KIT DE DISTRIBUCION CON B.A.	  
V6, 3.5 L	2009	36173 37026P 38410	POLEA POLEA DECOPLADORA TENSOR		4 CIL. 2.0 L 4 CIL. 2.2 L V6, 3.0 L	1995	T43096 T42030 T41075	TENSOR- POLEA DE DIST. TENSOR- POLEA DE DIST. TENSOR- POLEA DE DIST.	HIDRAULICO POLEA TENSORA POLEA
4 CIL. 2.4 L	2008	37017P 38453	POLEA DECOPLADORA TENSOR		4 CIL. 2.0 L 4 CIL. 2.2 L V6, 3.0 L	1994	TCKWP199 TCKWP199	KIT DE DISTRIBUCION CON B.A. KIT DE DISTRIBUCION CON B.A.	  
4 CIL. 2.4 L	2007	37017P 38453	POLEA DECOPLADORA TENSOR		4 CIL. 2.0 L 4 CIL. 2.2 L V6, 3.0 L	1994	T42030 T41075	TENSOR- POLEA DE DIST. TENSOR- POLEA DE DIST.	POLEA TENSORA POLEA
4 CIL. 2.4 L	2006	38216 38216	TENSOR TENSOR PARA BANDA MICRO-V		4 CIL. 2.0 L 4 CIL. 2.2 L V6, 3.0 L	1993	TCKWP199 TCKWP199	KIT DE DISTRIBUCION CON B.A. KIT DE DISTRIBUCION CON B.A.	  
V6, 3.0 L	2006	T43098 T42030 T42030 T43098	TENSOR- POLEA DE DIST. TENSOR- POLEA DE DIST. TENSOR- POLEA DE DIST. TENSOR- POLEA DE DIST.	POLEA TENSORA    	4 CIL. 2.0 L 4 CIL. 2.2 L V6, 3.0 L	1993 1993 1993	TCKWP199 TCKWP200 T42030	KIT DE DISTRIBUCION CON B.A. KIT DE DISTRIBUCION CON B.A. TENSOR- POLEA DE DIST.	    
V6, 3.3 L	2006	T42030	TENSOR- POLEA DE DIST.	POLEA TENSORA	4 CIL. 2.0 L	1992	TCKWP199	TENSOR- POLEA DE DIST. KIT DE DISTRIBUCION CON B.A.	POLEA POLEA TENSORA

4 CIL. 2.2 L	1992	TCKWP199	KIT DE DISTRIBUCION CON B.A.	
V6, 3.0 L	1992	TCKWP200	KIT DE DISTRIBUCION CON B.A.	
		T42030	SENSOR- POLEA DE DIST.	POLEA TENSORA
		T41075	SENSOR- POLEA DE DIST.	POLEA
4 CIL. 2.0 L	1991	TCKWP199	KIT DE DISTRIBUCION CON B.A.	
4 CIL. 2.2 L	1991	TCKWP199	KIT DE DISTRIBUCION CON B.A.	
V6, 2.5 L	1991	TCKWP157	KIT DE DISTRIBUCION CON B.A.	
4 CIL. 2.0 L	1990	TCKWP199	KIT DE DISTRIBUCION CON B.A.	
4 CIL. 2.2 L	1990	TCKWP199	KIT DE DISTRIBUCION CON B.A.	
V6, 2.5 L	1990	TCKWP157	KIT DE DISTRIBUCION CON B.A.	
V6, 2.5 L	1989	TCKWP157	KIT DE DISTRIBUCION CON B.A.	
V6, 2.5 L	1988	TCKWP157	KIT DE DISTRIBUCION CON B.A.	
4 CIL. 2.0 L	1986	T41070	SENSOR- POLEA DE DIST.	
4 CIL. 2.0 L Diesel	1986	T42027	SENSOR- POLEA DE DIST.	POLEA LOCA
		T41077	SENSOR- POLEA DE DIST.	
4 CIL. 1.8 L Diesel	1985	T42027	SENSOR- POLEA DE DIST.	POLEA LOCA
		T41077	SENSOR- POLEA DE DIST.	
4 CIL. 2.0 L	1985	T41070	SENSOR- POLEA DE DIST.	
4 CIL. 1.8 L Diesel	1984	T42027	SENSOR- POLEA DE DIST.	POLEA LOCA
		T41077	SENSOR- POLEA DE DIST.	
4 CIL. 2.0 L	1984	T41070	SENSOR- POLEA DE DIST.	
4 CIL. 2.0 L	1983	T41070	SENSOR- POLEA DE DIST.	

4 CIL. 2.0 L		TCKWP199	KIT DE DISTRIBUCION CON B.A.	
4 CIL. 2.2 L	1990	TCKWP199	KIT DE DISTRIBUCION CON B.A.	
4 CIL. 2.0 L	1986	T41070	SENSOR- POLEA DE DIST.	
6 CIL. 2.8 L	1985	T41069	SENSOR- POLEA DE DIST.	
6 CIL. 2.8 L	1984	T41069	SENSOR- POLEA DE DIST.	
6 CIL. 2.8 L	1983	T41069	SENSOR- POLEA DE DIST.	
6 CIL. 2.8 L	1982	T41069	SENSOR- POLEA DE DIST.	

**COROLLA**

4 CIL. 1.8 L	2010	37015P	POLEA DECOPLADORA	
4 CIL. 2.4 L	2010	37017P	POLEA DECOPLADORA	
		38453	TENSOR	
4 CIL. 1.8 L	2009	37015P	POLEA DECOPLADORA	
4 CIL. 2.4 L	2009	37017P	POLEA DECOPLADORA	
		38453	TENSOR	
4 CIL. 1.8 L	2008	38286	TENSOR	
		38018	TENSOR	
4 CIL. 1.8 L	2007	38286	TENSOR	
		38018	TENSOR	
4 CIL. 1.8 L	2006	38018	TENSOR	
		38286	TENSOR	
4 CIL. 1.8 L	2005	38018	TENSOR	
		38286	TENSOR	
4 CIL. 1.8 L	2004	38018	TENSOR	
		38286	TENSOR	
4 CIL. 1.8 L	2003	38286	TENSOR	
		38018	TENSOR	
4 CIL. 1.8 L	2002	38286	TENSOR	
		38018	TENSOR	
4 CIL. 1.6 L	1997	T41072	TENSOR- POLEA DE DIST.	
		T41072	TENSOR- POLEA DE DIST.	
4 CIL. 1.8 L	1997	T41072	TENSOR- POLEA DE DIST.	
		T41072	TENSOR- POLEA DE DIST.	
4 CIL. 1.6 L	1996	T41072	TENSOR- POLEA DE DIST.	
		T41072	TENSOR- POLEA DE DIST.	
4 CIL. 1.8 L	1996	T41072	TENSOR- POLEA DE DIST.	
		T41072	TENSOR- POLEA DE DIST.	
4 CIL. 1.6 L	1995	T41072	TENSOR- POLEA DE DIST.	
		T41072	TENSOR- POLEA DE DIST.	
4 CIL. 1.8 L	1995	T41072	TENSOR- POLEA DE DIST.	
		T41072	TENSOR- POLEA DE DIST.	
4 CIL. 1.6 L	1994	T41072	TENSOR- POLEA DE DIST.	
		T41072	TENSOR- POLEA DE DIST.	
4 CIL. 1.8 L	1994	T41072	TENSOR- POLEA DE DIST.	
		T41072	TENSOR- POLEA DE DIST.	
4 CIL. 1.6 L	1993	T41072	TENSOR- POLEA DE DIST.	
		T41072	TENSOR- POLEA DE DIST.	
4 CIL. 1.8 L	1993	T41072	TENSOR- POLEA DE DIST.	
		T41072	TENSOR- POLEA DE DIST.	
4 CIL. 1.6 L	1992	T41066	TENSOR- POLEA DE DIST.	
		T41066	TENSOR- POLEA DE DIST.	
4 CIL. 1.6 L	1991	T41066	TENSOR- POLEA DE DIST.	
4 CIL. 1.6 L	1990	T41066	TENSOR- POLEA DE DIST.	
4 CIL. 1.6 L	1989	T41074	TENSOR- POLEA DE DIST.	
		T41066	TENSOR- POLEA DE DIST.	
4 CIL. 1.6 L	1988	T41066	TENSOR- POLEA DE DIST.	
		T41066	TENSOR- POLEA DE DIST.	
		T41074	TENSOR- POLEA DE DIST.	
4 CIL. 1.6 L	1987	T41066	TENSOR- POLEA DE DIST.	
		T41074	TENSOR- POLEA DE DIST.	
		T41066	TENSOR- POLEA DE DIST.	
4 CIL. 1.6 L	1986	T41074	TENSOR- POLEA DE DIST.	
		T41066	TENSOR- POLEA DE DIST.	
4 CIL. 1.6 L	1985	T41066	TENSOR- POLEA DE DIST.	
		T41074	TENSOR- POLEA DE DIST.	
4 CIL. 1.8 L Diesel	1985	T42027	TENSOR- POLEA DE DIST.	POLEA LOCA
		T41077	TENSOR- POLEA DE DIST.	
4 CIL. 1.6 L	1984	T41066	TENSOR- POLEA DE DIST.	
4 CIL. 1.8 L Diesel	1984	T42027	TENSOR- POLEA DE DIST.	POLEA LOCA
		T41077	TENSOR- POLEA DE DIST.	
4 CIL. 1.6 L	1983	T41066	TENSOR- POLEA DE DIST.	

**CAMRY SOLARA**

V6, 3.0 L	2000	T41075	TENSOR- POLEA DE DIST.	POLEA
		T43096	TENSOR- POLEA DE DIST.	HIDRAULICO
		T42030	TENSOR- POLEA DE DIST.	POLEA TENSORA
V6, 3.0 L	1999	T43096	TENSOR- POLEA DE DIST.	HIDRAULICO
		T41075	TENSOR- POLEA DE DIST.	POLEA
		T42030	TENSOR- POLEA DE DIST.	POLEA TENSORA

**CELICA**

4 CIL. 1.8 L	2005	38286	TENSOR PARA BANDA MICRO-V	
4 CIL. 2.0 L	2001	TCKWP199	KIT DE DISTRIBUCION CON B.A.	
4 CIL. 2.2 L	2001	TCKWP199	KIT DE DISTRIBUCION CON B.A.	
4 CIL. 2.0 L	2000	TCKWP199	KIT DE DISTRIBUCION CON B.A.	
4 CIL. 2.2 L	2000	TCKWP199	KIT DE DISTRIBUCION CON B.A.	
4 CIL. 2.0 L	1999	TCKWP199	KIT DE DISTRIBUCION CON B.A.	
4 CIL. 2.2 L	1999	TCKWP199	KIT DE DISTRIBUCION CON B.A.	
4 CIL. 2.0 L	1998	TCKWP199	KIT DE DISTRIBUCION CON B.A.	
4 CIL. 2.2 L	1998	TCKWP199	KIT DE DISTRIBUCION CON B.A.	
4 CIL. 1.8 L	1997	T41072	TENSOR- POLEA DE DIST.	
		T41072	TENSOR- POLEA DE DIST.	
4 CIL. 2.0 L	1997	TCKWP199	KIT DE DISTRIBUCION CON B.A.	
4 CIL. 2.2 L	1997	TCKWP199	KIT DE DISTRIBUCION CON B.A.	
4 CIL. 1.8 L	1996	T41072	TENSOR- POLEA DE DIST.	
		T41072	TENSOR- POLEA DE DIST.	
4 CIL. 2.0 L	1996	TCKWP199	KIT DE DISTRIBUCION CON B.A.	
4 CIL. 2.2 L	1996	TCKWP199	KIT DE DISTRIBUCION CON B.A.	
4 CIL. 1.8 L	1995	T41072	TENSOR- POLEA DE DIST.	
		T41072	TENSOR- POLEA DE DIST.	
4 CIL. 2.0 L	1995	TCKWP199	KIT DE DISTRIBUCION CON B.A.	
4 CIL. 2.2 L	1995	TCKWP199	KIT DE DISTRIBUCION CON B.A.	
4 CIL. 1.8 L	1994	T41072	TENSOR- POLEA DE DIST.	
		T41072	TENSOR- POLEA DE DIST.	
4 CIL. 2.0 L	1994	TCKWP199	KIT DE DISTRIBUCION CON B.A.	
4 CIL. 2.2 L	1994	TCKWP199	KIT DE DISTRIBUCION CON B.A.	
4 CIL. 1.6 L	1993	T41066	TENSOR- POLEA DE DIST.	
		T41066	TENSOR- POLEA DE DIST.	
4 CIL. 2.0 L	1993	TCKWP199	KIT DE DISTRIBUCION CON B.A.	
		T41182	TENSOR- POLEA DE DIST.	POLEA
4 CIL. 2.2 L	1993	TCKWP199	KIT DE DISTRIBUCION CON B.A.	
4 CIL. 1.6 L	1992	T41066	TENSOR- POLEA DE DIST.	
		T41066	TENSOR- POLEA DE DIST.	
4 CIL. 2.0 L	1992	TCKWP199	KIT DE DISTRIBUCION CON B.A.	
		T41182	TENSOR- POLEA DE DIST.	POLEA
4 CIL. 2.2 L	1992	TCKWP199	KIT DE DISTRIBUCION CON B.A.	
4 CIL. 1.6 L	1991	T41066	TENSOR- POLEA DE DIST.	
4 CIL. 2.0 L	1991	TCKWP199	KIT DE DISTRIBUCION CON B.A.	
4 CIL. 2.2 L	1991	TCKWP199	KIT DE DISTRIBUCION CON B.A.	
4 CIL. 1.6 L	1990	T41066	TENSOR- POLEA DE DIST.	



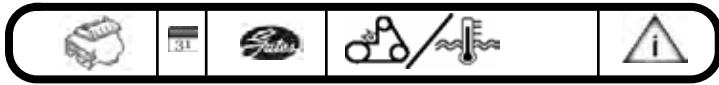

**CRESSIDA**

6 CIL. 2.8 L	1988	T41069	TENSOR- POLEA DE DIST.	
6 CIL. 2.8 L	1987	T41069	TENSOR- POLEA DE DIST.	
6 CIL. 2.8 L	1986	T41069	TENSOR- POLEA DE DIST.	
6 CIL. 2.8 L	1985	T41069	TENSOR- POLEA DE DIST.	
6 CIL. 2.8 L	1984	T41069	TENSOR- POLEA DE DIST.	
6 CIL. 2.8 L	1983	T41069	TENSOR- POLEA DE DIST.	

**FJ CRUISER**

V6, 4.0 L	2008	38411	TENSOR	
		38411	TENSOR PARA BANDA MICRO-V	
V6, 4.0 L	2007	38411	TENSOR	

**HIGHLANDER**

V6, 3.5 L	2010	36173	POLEA	
		37026P	POLEA DECOPLADORA	
		38410	TENSOR	
V6, 3.5 L	2009	36173	POLEA	
		37026P	POLEA DECOPLADORA	
		38410	TENSOR	
V6, 3.3 L (Canada)	2008	T42030	TENSOR- POLEA DE DIST.	POLEA TENSORA
V6, 3.3 L Electric Assist	2008	T42030	TENSOR- POLEA DE DIST.	POLEA TENSORA
V6, 3.5 L	2008	36173	POLEA	
		37026P	POLEA DECOPLADORA	
		38410	TENSOR	
V6, 3.3 L	2007	T42030	TENSOR- POLEA DE DIST.	POLEA TENSORA
V6, 3.3 L Electric Assist	2007	T42030	TENSOR- POLEA DE DIST.	POLEA TENSORA
V6, 3.3 L	2006	T42030	TENSOR- POLEA DE DIST.	POLEA TENSORA
V6, 3.3 L Electric Assist	2006	T42030	TENSOR- POLEA DE DIST.	POLEA TENSORA
V6, 3.3 L	2005	T42030	TENSOR- POLEA DE DIST.	POLEA TENSORA
V6, 3.3 L	2004	T42030	TENSOR- POLEA DE DIST.	POLEA TENSORA
V6, 3.0 L	2003	T42030	TENSOR- POLEA DE DIST.	POLEA TENSORA
V6, 3.0 L	2002	T42030	TENSOR- POLEA DE DIST.	POLEA TENSORA
V6, 3.0 L	2001	T42030	TENSOR- POLEA DE DIST.	POLEA TENSORA

**LAND CRUISER**

V8, 4.7 L	2007	TCK298	KIT DE DISTRIBUCION	
		38173	TENSOR	
V8, 4.7 L	2006	36026	POLEA	
		36119	POLEA	
		38173	TENSOR	
		T41078	TENSOR- POLEA DE DIST.	
		T42031	TENSOR- POLEA DE DIST.	
		T43097	TENSOR- POLEA DE DIST.	
V8, 4.7 L	2005	36026	POLEA	
		36119	POLEA	
		38173	TENSOR	
		T41078	TENSOR- POLEA DE DIST.	
		T42031	TENSOR- POLEA DE DIST.	
		T43097	TENSOR- POLEA DE DIST.	
V8, 4.7 L	2004	36026	POLEA	
		36119	POLEA	
		38173	TENSOR	
		T43097	TENSOR- POLEA DE DIST.	
		T42031	TENSOR- POLEA DE DIST.	
		T41078	TENSOR- POLEA DE DIST.	
V8, 4.7 L	2003	36119	POLEA	
		36026	POLEA	
		38173	TENSOR	
		T41078	TENSOR- POLEA DE DIST.	
		T43097	TENSOR- POLEA DE DIST.	
		T42031	TENSOR- POLEA DE DIST.	

**MATRIX**

4 CIL. 1.8 L	2010	37015P	POLEA DECOPLADORA	
4 CIL. 2.4 L	2010	37017P	POLEA DECOPLADORA	
		38453	TENSOR	
4 CIL. 1.8 L	2009	37015P	POLEA DECOPLADORA	

4 CIL. 2.4 L		37017P	POLEA DECOPLADORA	
		38453	TENSOR	
4 CIL. 1.8 L	2008	38286	TENSOR	
		38018	TENSOR	
4 CIL. 1.8 L	2007	38286	TENSOR	
		38018	TENSOR	
4 CIL. 1.8 L	2006	38286	TENSOR	
		38018	TENSOR	
4 CIL. 1.8 L	2005	38286	TENSOR	
		38018	TENSOR	
4 CIL. 1.8 L	2004	38286	TENSOR	
		38018	TENSOR	
4 CIL. 1.8 L	2003	38018	TENSOR	
		38286	TENSOR	

**MR2**

4 CIL. 2.0 L	2001	TCKWP199	KIT DE DISTRIBUCION CON B.A.	
4 CIL. 2.2 L	2001	TCKWP199	KIT DE DISTRIBUCION CON B.A.	
4 CIL. 2.0 L	2000	TCKWP199	KIT DE DISTRIBUCION CON B.A.	
4 CIL. 2.2 L	2000	TCKWP199	KIT DE DISTRIBUCION CON B.A.	
4 CIL. 2.0 L	1999	TCKWP199	KIT DE DISTRIBUCION CON B.A.	
4 CIL. 2.2 L	1999	TCKWP199	KIT DE DISTRIBUCION CON B.A.	
4 CIL. 2.0 L	1998	TCKWP199	KIT DE DISTRIBUCION CON B.A.	
4 CIL. 2.2 L	1998	TCKWP199	KIT DE DISTRIBUCION CON B.A.	
4 CIL. 2.0 L	1997	TCKWP199	KIT DE DISTRIBUCION CON B.A.	
4 CIL. 2.2 L	1997	TCKWP199	KIT DE DISTRIBUCION CON B.A.	
4 CIL. 2.0 L	1996	TCKWP199	KIT DE DISTRIBUCION CON B.A.	
4 CIL. 2.2 L	1996	TCKWP199	KIT DE DISTRIBUCION CON B.A.	
4 CIL. 2.0 L	1995	TCKWP199	KIT DE DISTRIBUCION CON B.A.	
4 CIL. 2.2 L	1995	TCKWP199	KIT DE DISTRIBUCION CON B.A.	
4 CIL. 2.0 L	1994	TCKWP199	KIT DE DISTRIBUCION CON B.A.	
4 CIL. 2.2 L	1994	TCKWP199	KIT DE DISTRIBUCION CON B.A.	
4 CIL. 2.0 L	1993	TCKWP199	KIT DE DISTRIBUCION CON B.A.	
4 CIL. 2.2 L	1993	TCKWP199	KIT DE DISTRIBUCION CON B.A.	
4 CIL. 2.0 L	1992	TCKWP199	KIT DE DISTRIBUCION CON B.A.	
4 CIL. 2.2 L	1992	TCKWP199	KIT DE DISTRIBUCION CON B.A.	
4 CIL. 2.0 L	1991	TCKWP199	KIT DE DISTRIBUCION CON B.A.	
4 CIL. 2.2 L	1991	TCKWP199	KIT DE DISTRIBUCION CON B.A.	
4 CIL. 2.0 L	1990	TCKWP199	KIT DE DISTRIBUCION CON B.A.	
4 CIL. 2.2 L	1990	TCKWP199	KIT DE DISTRIBUCION CON B.A.	
4 CIL. 1.6 L	1989	T41074	TENSOR- POLEA DE DIST.	
4 CIL. 1.6 L	1988	T41074	TENSOR- POLEA DE DIST.	
4 CIL. 1.6 L	1987	T41074	TENSOR- POLEA DE DIST.	
4 CIL. 1.6 L	1986	T41074	TENSOR- POLEA DE DIST.	
4 CIL. 1.6 L	1985	T41074	TENSOR- POLEA DE DIST.	

**PASEO**

4 CIL. 1.5 L (Canada)	1999	T41071	TENSOR- POLEA DE DIST.	
		T42029	TENSOR- POLEA DE DIST.	POLEA LOCA
4 CIL. 1.5 L (Canada)	1998	T41071	TENSOR- POLEA DE DIST.	
		T42029	TENSOR- POLEA DE DIST.	POLEA LOCA
4 CIL. 1.5 L	1997	T42029	TENSOR- POLEA DE DIST.	POLEA LOCA
		T41071	TENSOR- POLEA DE DIST.	
4 CIL. 1.5 L	1996	T42029	TENSOR- POLEA DE DIST.	POLEA LOCA
		T41071	TENSOR- POLEA DE DIST.	
4 CIL. 1.5 L	1995	T42029	TENSOR- POLEA DE DIST.	POLEA LOCA
		T41071	TENSOR- POLEA DE DIST.	
4 CIL. 1.5 L	1994	T41071	TENSOR- POLEA DE DIST.	
		T42029	TENSOR- POLEA DE DIST.	POLEA LOCA
4 CIL. 1.5 L	1993	T42029	TENSOR- POLEA DE DIST.	POLEA LOCA
		T41071	TENSOR- POLEA DE DIST.	
4 CIL. 1.5 L	1992	T41071	TENSOR- POLEA DE DIST.	
		T42029	TENSOR- POLEA DE DIST.	POLEA LOCA

**PICKUP**

V6, 3.0 L	1995	TCKWP240B	KIT DE DISTRIBUCION CON B.A.	
		TCKWP240	KIT DE DISTRIBUCION CON B.A.	
		T41073	TENSOR- POLEA DE DIST.	
		T42037	TENSOR- POLEA DE DIST.	POLEA TENSORA
		T41203	TENSOR- POLEA DE DIST.	POLEA

V6, 3.0 L	1995	T41203	TENSOR- POLEA DE DIST.	(DEL TENSOR)
		T42037	TENSOR- POLEA DE DIST.	POLEA LOCA
V6, 3.0 L	1994	TCKWP240B	KIT DE DISTRIBUCION CON B.A.	
		TCKWP240	KIT DE DISTRIBUCION CON B.A.	
		T42037	TENSOR- POLEA DE DIST.	POLEA TENSORA
		T41203	TENSOR- POLEA DE DIST.	(DEL TENSOR)
		T42037	TENSOR- POLEA DE DIST.	POLEA LOCA
		T41073	TENSOR- POLEA DE DIST.	
		T41203	TENSOR- POLEA DE DIST.	POLEA
V6, 3.0 L	1993	TCKWP240	KIT DE DISTRIBUCION CON B.A.	
		T42037	TENSOR- POLEA DE DIST.	POLEA TENSORA
		T41073	TENSOR- POLEA DE DIST.	
		T41203	TENSOR- POLEA DE DIST.	POLEA
		T41203	TENSOR- POLEA DE DIST.	(DEL TENSOR)
		T42037	TENSOR- POLEA DE DIST.	POLEA LOCA
V6, 3.0 L	1992	T42037	TENSOR- POLEA DE DIST.	POLEA TENSORA
		T42037	TENSOR- POLEA DE DIST.	POLEA LOCA
		T41203	TENSOR- POLEA DE DIST.	POLEA
		T41073	TENSOR- POLEA DE DIST.	
V6, 3.0 L	1991	T41073	TENSOR- POLEA DE DIST.	
		T42037	TENSOR- POLEA DE DIST.	POLEA LOCA
V6, 3.0 L	1990	T41073	TENSOR- POLEA DE DIST.	
		T42037	TENSOR- POLEA DE DIST.	POLEA LOCA
V6, 3.0 L	1989	T41073	TENSOR- POLEA DE DIST.	
		T42037	TENSOR- POLEA DE DIST.	POLEA LOCA
V6, 3.0 L	1988	T41073	TENSOR- POLEA DE DIST.	
		T42037	TENSOR- POLEA DE DIST.	POLEA LOCA
4 CIL. 2.4 L Diesel (Canada)	1987	T42026	TENSOR- POLEA DE DIST.	POLEA LOCA
		T41068	TENSOR- POLEA DE DIST.	POLEA LOCA
4 CIL. 2.4 L Diesel	1986	T41068	TENSOR- POLEA DE DIST.	
		T42026	TENSOR- POLEA DE DIST.	POLEA LOCA
4 CIL. 2.4 L Diesel	1985	T41068	TENSOR- POLEA DE DIST.	
		T42026	TENSOR- POLEA DE DIST.	POLEA LOCA
4 CIL. 2.4 L Diesel	1984	T42026	TENSOR- POLEA DE DIST.	POLEA LOCA
		T41068	TENSOR- POLEA DE DIST.	
4 CIL. 2.2 L Diesel	1983	T41068	TENSOR- POLEA DE DIST.	
		T42026	TENSOR- POLEA DE DIST.	POLEA LOCA
4 CIL. 2.2 L Diesel	1982	T41068	TENSOR- POLEA DE DIST.	
		T42026	TENSOR- POLEA DE DIST.	POLEA LOCA
4 CIL. 2.2 L Diesel	1981	T41068	TENSOR- POLEA DE DIST.	
		T42026	TENSOR- POLEA DE DIST.	POLEA LOCA

4 CIL. 2.0 L	1995	TCKWP199	KIT DE DISTRIBUCION CON B.A.	
4 CIL. 2.2 L	1995	TCKWP199	KIT DE DISTRIBUCION CON B.A.	
4 CIL. 2.0 L	1994	TCKWP199	KIT DE DISTRIBUCION CON B.A.	
4 CIL. 2.2 L	1994	TCKWP199	KIT DE DISTRIBUCION CON B.A.	
4 CIL. 2.0 L	1993	TCKWP199	KIT DE DISTRIBUCION CON B.A.	
4 CIL. 2.2 L	1993	TCKWP199	KIT DE DISTRIBUCION CON B.A.	
4 CIL. 2.0 L	1992	TCKWP199	KIT DE DISTRIBUCION CON B.A.	
4 CIL. 2.2 L	1992	TCKWP199	KIT DE DISTRIBUCION CON B.A.	
4 CIL. 2.0 L	1991	TCKWP199	KIT DE DISTRIBUCION CON B.A.	
4 CIL. 2.2 L	1991	TCKWP199	KIT DE DISTRIBUCION CON B.A.	
4 CIL. 2.0 L	1990	TCKWP199	KIT DE DISTRIBUCION CON B.A.	
4 CIL. 2.2 L	1990	TCKWP199	KIT DE DISTRIBUCION CON B.A.	

**SEQUOIA**

V8, 4.7 L	2008	36119	POLEA	
		36026	POLEA	
		38173	TENSOR	
		T42031	TENSOR- POLEA DE DIST.	
		T41078	TENSOR- POLEA DE DIST.	
V8, 4.7 L	2007	36119	POLEA	
		36026	POLEA	
		38173	TENSOR	
		T41078	TENSOR- POLEA DE DIST.	
		T42031	TENSOR- POLEA DE DIST.	

**SIENNA**

V6, 3.5 L	2011	36173	POLEA	
		37026P	POLEA DECOPLADORA	
		38410	TENSOR	
V6, 3.5 L	2010	36173	POLEA	
		37026P	POLEA DECOPLADORA	
		38410	TENSOR	
V6, 3.5 L	2009	36173	POLEA	
		37026P	POLEA DECOPLADORA	
		38410	TENSOR	
V6, 3.5 L	2008	36173	POLEA	
		37026P	POLEA DECOPLADORA	
		38410	TENSOR	
V6, 3.5 L	2007	36173	POLEA	
		37026P	POLEA DECOPLADORA	
		38410	TENSOR	
V6, 3.5 L	2006	T42030	TENSOR- POLEA DE DIST.	
		T42030	TENSOR- POLEA DE DIST.	POLEA TENSORA
		T43098	TENSOR- POLEA DE DIST.	
V6, 3.3 L	2005	T42030	TENSOR- POLEA DE DIST.	
		T43098	TENSOR- POLEA DE DIST.	POLEA TENSORA
		T42030	TENSOR- POLEA DE DIST.	
V6, 3.3 L	2004	T42030	TENSOR- POLEA DE DIST.	
		T42030	TENSOR- POLEA DE DIST.	POLEA TENSORA
		T43098	TENSOR- POLEA DE DIST.	
V6, 3.0 L	2003	TCK257	KIT DE DISTRIBUCION	
		T42030	TENSOR- POLEA DE DIST.	
		T41075	TENSOR- POLEA DE DIST.	
		T43096	TENSOR- POLEA DE DIST.	
		T42030	TENSOR- POLEA DE DIST.	POLEA TENSORA
		T43096	TENSOR- POLEA DE DIST.	HIDRAULICO
		T41075	TENSOR- POLEA DE DIST.	POLEA
V6, 3.0 L	2002	TCK257	KIT DE DISTRIBUCION	
		T43096	TENSOR- POLEA DE DIST.	
		T42030	TENSOR- POLEA DE DIST.	POLEA TENSORA
		T42030	TENSOR- POLEA DE DIST.	
		T43096	TENSOR- POLEA DE DIST.	HIDRAULICO
		T41075	TENSOR- POLEA DE DIST.	
V6, 3.0 L	2001	TCK257	KIT DE DISTRIBUCION	
		T43096	TENSOR- POLEA DE DIST.	
		T43096	TENSOR- POLEA DE DIST.	HIDRAULICO
		T41075	TENSOR- POLEA DE DIST.	
		T41075	TENSOR- POLEA DE DIST.	POLEA
		T42030	TENSOR- POLEA DE DIST.	
		T42030	TENSOR- POLEA DE DIST.	POLEA TENSORA

**RAV 4**

V6, 3.5 L	2010	36173	POLEA	
		37026P	POLEA DECOPLADORA	
		38410	TENSOR	
V6, 3.5 L	2009	36173	POLEA	
		37026P	POLEA DECOPLADORA	
		38410	TENSOR	
4 CIL. 2.4 L	2008	37017P	POLEA DECOPLADORA	
V6, 3.5 L	2008	36173	POLEA	
		37026P	POLEA DECOPLADORA	
		38410	TENSOR	
4 CIL. 2.4 L	2007	37017P	POLEA DECOPLADORA	
		38216	TENSOR	
4 CIL. 2.4 L	2006	38216	TENSOR	
4 CIL. 2.4 L	2005	38216	TENSOR	
4 CIL. 2.4 L	2004	38216	TENSOR	
4 CIL. 2.0 L	2003	38216	TENSOR	
4 CIL. 2.0 L	2001	TCKWP199	KIT DE DISTRIBUCION CON B.A.	
4 CIL. 2.2 L	2001	TCKWP199	KIT DE DISTRIBUCION CON B.A.	
4 CIL. 2.0 L	2000	TCKWP199	KIT DE DISTRIBUCION CON B.A.	
4 CIL. 2.0 L	2000	TCKWP199	KIT DE DISTRIBUCION CON B.A.	
4 CIL. 2.0 L	1999	TCKWP199	KIT DE DISTRIBUCION CON B.A.	
4 CIL. 2.2 L	1999	TCKWP199	KIT DE DISTRIBUCION CON B.A.	
4 CIL. 2.0 L	1998	TCKWP199	KIT DE DISTRIBUCION CON B.A.	
4 CIL. 2.2 L	1998	TCKWP199	KIT DE DISTRIBUCION CON B.A.	
4 CIL. 2.0 L	1997	TCKWP199	KIT DE DISTRIBUCION CON B.A.	
4 CIL. 2.2 L	1997	TCKWP199	KIT DE DISTRIBUCION CON B.A.	
4 CIL. 2.0 L	1996	TCKWP199	KIT DE DISTRIBUCION CON B.A.	
4 CIL. 2.2 L	1996	TCKWP199	KIT DE DISTRIBUCION CON B.A.	



4 CIL. 2.0 L	2006	38148	TENSOR				T43010	TENSOR- POLEA DE DIST.	
4 CIL. 1.8 L	2005	TCKWP306	KIT DE DISTRIBUCION CON B.A.				TCKWP306	KIT DE DISTRIBUCION CON B.A.	
		38148	TENSOR				37013P	POLEA DECOPLADORA	
		38018	TENSOR				38148	TENSOR	
		T43025	TENSOR- POLEA DE DIST.	HIDRAULICO			38018	TENSOR	
4 CIL. 2.0 L	2005	TCK296	KIT DE DISTRIBUCION				T43028	TENSOR- POLEA DE DIST.	HIDRAULICO
		TCKWP296	KIT DE DISTRIBUCION CON B.A.				TCKWP321	KIT DE DISTRIBUCION CON B.A.	
		38148	TENSOR				T43007	TENSOR- POLEA DE DIST.	
		38018	TENSOR				T42050	TENSOR- POLEA DE DIST.	POLEA TENSORA
		T43010	TENSOR- POLEA DE DIST.				T42044	TENSOR- POLEA DE DIST.	POLEA TENSORA
4 CIL. 1.8 L	2004	T43010	TENSOR- POLEA DE DIST.				TCK296	KIT DE DISTRIBUCION	
		TCKWP306	KIT DE DISTRIBUCION CON B.A.				TCKWP296	KIT DE DISTRIBUCION CON B.A.	
		38148	TENSOR				37013P	POLEA DECOPLADORA	
		38018	TENSOR				38018	TENSOR	
		T43025	TENSOR- POLEA DE DIST.	HIDRAULICO			38148	TENSOR	
4 CIL. 1.9 L	2004	T43007	TENSOR- POLEA DE DIST.				T43010	TENSOR- POLEA DE DIST.	
4 CIL. 1.9 L DIESEL	2004	TCKWP321	KIT DE DISTRIBUCION CON B.A.				TCKWP306	KIT DE DISTRIBUCION CON B.A.	
		T43007	TENSOR- POLEA DE DIST.				37013P	POLEA DECOPLADORA	
		T42050	TENSOR- POLEA DE DIST.				38148	TENSOR	
		T42044	TENSOR- POLEA DE DIST.	POLEA TENSORA			38018	TENSOR	
4 CIL. 2.0 L	2004	TCK296	KIT DE DISTRIBUCION				T43025	TENSOR- POLEA DE DIST.	HIDRAULICO
		TCKWP296	KIT DE DISTRIBUCION CON B.A.				TCKWP321	KIT DE DISTRIBUCION CON B.A.	
		38148	TENSOR				T42044	TENSOR- POLEA DE DIST.	POLEA TENSORA
		38018	TENSOR				T42050	TENSOR- POLEA DE DIST.	POLEA TENSORA
		T43010	TENSOR- POLEA DE DIST.				T43007	TENSOR- POLEA DE DIST.	
4 CIL. 1.8 L	2003	TCKWP306	KIT DE DISTRIBUCION CON B.A.				TCK296	KIT DE DISTRIBUCION	
		37013P	POLEA DECOPLADORA				TCKWP296	KIT DE DISTRIBUCION CON B.A.	
		38018	TENSOR				37013P	POLEA DECOPLADORA	
		38148	TENSOR				38018	TENSOR	
		T43025	TENSOR- POLEA DE DIST.	HIDRAULICO			38148	TENSOR	
4 CIL. 1.9 L	2003	38192	TENSOR PARA BANDA MICRO-V				T43010	TENSOR- POLEA DE DIST.	
4 CIL. 1.9 L DIESEL	2003	TCKWP321	KIT DE DISTRIBUCION CON B.A.				TCKWP321	KIT DE DISTRIBUCION CON B.A.	
		T42044	TENSOR- POLEA DE DIST.	POLEA TENSORA			T42050	TENSOR- POLEA DE DIST.	POLEA TENSORA
		T43007	TENSOR- POLEA DE DIST.				T42044	TENSOR- POLEA DE DIST.	POLEA TENSORA
		T42050	TENSOR- POLEA DE DIST.	POLEA TENSORA			T43007	TENSOR- POLEA DE DIST.	
4 CIL. 2.0 L	2003	TCK296	KIT DE DISTRIBUCION				TCK296	KIT DE DISTRIBUCION	
		TCKWP296	KIT DE DISTRIBUCION CON B.A.				TCKWP296	KIT DE DISTRIBUCION CON B.A.	
		37013P	POLEA DECOPLADORA				37013P	POLEA DECOPLADORA	
		38018	TENSOR				38148	TENSOR	
		38148	TENSOR				38018	TENSOR	
		T43010	TENSOR- POLEA DE DIST.				T43010	TENSOR- POLEA DE DIST.	
4 CIL. 1.8 L	2002	TCKWP306	KIT DE DISTRIBUCION CON B.A.				TCKWP321	KIT DE DISTRIBUCION CON B.A.	
		37013P	POLEA DECOPLADORA				T42050	TENSOR- POLEA DE DIST.	
		38018	TENSOR				T42044	TENSOR- POLEA DE DIST.	
		38148	TENSOR				T43007	TENSOR- POLEA DE DIST.	
		T43025	TENSOR- POLEA DE DIST.	HIDRAULICO			T42044	TENSOR- POLEA DE DIST.	
4 CIL. 1.9 L DIESEL	2002	TCKWP321	KIT DE DISTRIBUCION CON B.A.				T42050	TENSOR- POLEA DE DIST.	
		T42050	TENSOR- POLEA DE DIST.	POLEA TENSORA			TCK296	KIT DE DISTRIBUCION	
		T43007	TENSOR- POLEA DE DIST.				TCKWP296	KIT DE DISTRIBUCION CON B.A.	
		T42044	TENSOR- POLEA DE DIST.	POLEA TENSORA			37013P	POLEA DECOPLADORA	
4 CIL. 2.0 L	2002	TCK296	KIT DE DISTRIBUCION				38018	TENSOR	
		TCKWP296	KIT DE DISTRIBUCION CON B.A.				38148	TENSOR	
		37013P	POLEA DECOPLADORA				T43010	TENSOR- POLEA DE DIST.	
		38018	TENSOR				TCKWP306	KIT DE DISTRIBUCION CON B.A.	
		38148	TENSOR				37013P	POLEA DECOPLADORA	
		T43010	TENSOR- POLEA DE DIST.				38018	TENSOR	
4 CIL. 1.8 L	2001	TCKWP306	KIT DE DISTRIBUCION CON B.A.				38148	TENSOR	
		37013P	POLEA DECOPLADORA				T43028	TENSOR- POLEA DE DIST.	
		38018	TENSOR				37012P	POLEA DECOPLADORA	
		38148	TENSOR				TCKWP321	KIT DE DISTRIBUCION CON B.A.	
		T43028	TENSOR- POLEA DE DIST.	HIDRAULICO			T43007	TENSOR- POLEA DE DIST.	
4 CIL. 1.9 L	2001	37012P	POLEA DECOPLADORA				T42050	TENSOR- POLEA DE DIST.	
4 CIL. 1.9 L DIESEL	2001	TCKWP321	KIT DE DISTRIBUCION CON B.A.				T42044	TENSOR- POLEA DE DIST.	
		T43007	TENSOR- POLEA DE DIST.				TCK296	KIT DE DISTRIBUCION	
		T42050	TENSOR- POLEA DE DIST.	POLEA TENSORA			TCKWP296	KIT DE DISTRIBUCION CON B.A.	
		T42044	TENSOR- POLEA DE DIST.	POLEA TENSORA			37013P	POLEA DECOPLADORA	
4 CIL. 2.0 L	2001	TCK296	KIT DE DISTRIBUCION				38148	TENSOR	
		TCKWP296	KIT DE DISTRIBUCION CON B.A.				38018	TENSOR	
		37013P	POLEA DECOPLADORA				38148	TENSOR	
		38148	TENSOR				T43010	TENSOR- POLEA DE DIST.	
		38018	TENSOR						

**BORA**

1.9 L DIESEL	2010	TCK333M	KIT DE DISTRIBUCION	
4 CIL. 2.0 L DIESEL	2010	T41229	TENSOR- POLEA DE DIST.	
1.9 L DIESEL	2009	TCK333M	KIT DE DISTRIBUCION	
4 CIL. 2.0 L DIESEL	2009	T41229	TENSOR- POLEA DE DIST.	
5 CIL. 2.5 L	2009	36105	POLEA	ALT. B.A. Y D.H.
		36106	POLEA	A.A.
		38315	TENSOR	ALT. B.A. Y D.H.
		38314	TENSOR	A.A.
1.9 L DIESEL	2008	TCK333M	KIT DE DISTRIBUCION	
5 CIL. 2.5 L	2008	36105	POLEA	ALT. B.A. Y D.H.
		36106	POLEA	A.A.
		38314	TENSOR	A.A.
		38315	TENSOR	ALT. B.A. Y D.H.
4 CIL. 1.9 L DIESEL	2007	38018	TENSOR	
		T43091	TENSOR- POLEA DE DIST.	
		T43091	TENSOR- POLEA DE DIST.	
		T41229	TENSOR- POLEA DE DIST.	
		T41229	TENSOR- POLEA DE DIST.	
5 CIL. 2.5 L	2007	36105	POLEA	ALT. B.A. Y D.H.
		36106	POLEA	A.A.
		38314	TENSOR	A.A.
		38315	TENSOR	ALT. B.A. Y D.H.
5 CIL. 2.5 L	2006	36106	POLEA	A.A.
		36105	POLEA	ALT. B.A. Y D.H.
		38314	TENSOR	A.A.
		38315	TENSOR	ALT. B.A. Y D.H.
5 CIL. 2.5 L	2005	36105	POLEA	ALT. B.A. Y D.H.
		36106	POLEA	A.A.
		38315	TENSOR	ALT. B.A. Y D.H.

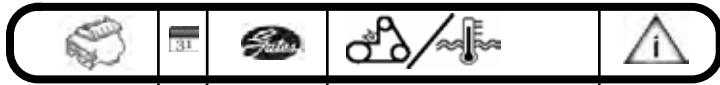

5 CIL. 2.5 L	2005	38314	TENSOR	A.A.
--------------	------	-------	--------	------

**BORA SPORTWAGEN**

5 CIL. 2.5 L	2009	36105	POLEA	ALT. B.A. Y D.H.
		36106	POLEA	A.A.
		38314	TENSOR	A.A.
5 CIL. 2.5 L	2008	38315	TENSOR	ALT. B.A. Y D.H.
		36105	POLEA	A.A.
		36106	POLEA	ALT. B.A. Y D.H.
		38314	TENSOR	A.A.

**CABRIO**

4 CIL. 2.0 L	2002	TCK260M	KIT DE DISTRIBUCION	
		TCK260M	KIT DE DISTRIBUCION	
		TCK262	KIT DE DISTRIBUCION	
		38087	POLEA	ALT. Y.A.A.
		38147	TENSOR	
		38087	TENSOR	ALT. Y.A.A.
		38147	TENSOR PARA BANDA MICRO-V	
		T41079	TENSOR- POLEA DE DIST.	
		T41079	TENSOR- POLEA DE DIST.	
		T41079	TENSOR- POLEA DE DIST.	
4 CIL. 2.0 L	2001	TCK262	KIT DE DISTRIBUCION	
		TCK260M	KIT DE DISTRIBUCION	
		38147	TENSOR	
		38087	TENSOR	ALT. Y.A.A.
		T41079	TENSOR- POLEA DE DIST.	
		TCK262	KIT DE DISTRIBUCION	
		TCK260M	KIT DE DISTRIBUCION	
		38147	TENSOR	
		38087	TENSOR	ALT. Y.A.A.
		T41079	TENSOR- POLEA DE DIST.	
4 CIL. 2.0 L	2000	TCK262	KIT DE DISTRIBUCION	
		TCK260M	KIT DE DISTRIBUCION	
		38147	TENSOR	
		38087	TENSOR	ALT. Y.A.A.
		T41079	TENSOR- POLEA DE DIST.	
		TCK262	KIT DE DISTRIBUCION	
		TCK260M	KIT DE DISTRIBUCION	
		38147	TENSOR	
		38087	TENSOR	ALT. Y.A.A.
		T41079	TENSOR- POLEA DE DIST.	
4 CIL. 2.0 L	1999	TCK260M	KIT DE DISTRIBUCION	
		TCK262	KIT DE DISTRIBUCION	
		38087	TENSOR	ALT. Y.A.A.
		38147	TENSOR	SIDOBLE MICRO V
		T41079	TENSOR- POLEA DE DIST.	
		TCK260M	KIT DE DISTRIBUCION	
		TCK262	KIT DE DISTRIBUCION	
		38147	TENSOR	
		38087	TENSOR	ALT. Y.A.A.
		T41079	TENSOR- POLEA DE DIST.	
4 CIL. 2.0 L	1998	TCK260M	KIT DE DISTRIBUCION	
		TCK262	KIT DE DISTRIBUCION	
		38147	TENSOR	
		38087	TENSOR	ALT. Y.A.A.
		T41079	TENSOR- POLEA DE DIST.	
		TCK260M	KIT DE DISTRIBUCION	
		TCK262	KIT DE DISTRIBUCION	
		38147	TENSOR	
		38087	TENSOR	ALT. Y.A.A.
		T41079	TENSOR- POLEA DE DIST.	
4 CIL. 2.0 L	1997	TCK260M	KIT DE DISTRIBUCION	
		TCK262	KIT DE DISTRIBUCION	
		38147	TENSOR	
		38087	TENSOR	ALT. Y.A.A.
		T41079	TENSOR- POLEA DE DIST.	
		TCK260M	KIT DE DISTRIBUCION	
		TCK262	KIT DE DISTRIBUCION	
		38147	TENSOR	
		38087	TENSOR	ALT. Y.A.A.
		T41079	TENSOR- POLEA DE DIST.	
4 CIL. 2.0 L	1996	TCK260M	KIT DE DISTRIBUCION	
		TCK262A	KIT DE DISTRIBUCION	
		TCK262	KIT DE DISTRIBUCION	
		38147	TENSOR	
		38087	TENSOR	ALT. Y.A.A.
		T41079	TENSOR- POLEA DE DIST.	
		TCK262	KIT DE DISTRIBUCION	
		TCK260M	KIT DE DISTRIBUCION	
		38147	TENSOR	
		38087	TENSOR	ALT. Y.A.A.
T41079	TENSOR- POLEA DE DIST.			

**CRAFTER**

5 CIL. 2.5 L TDI	2010	T43067	TENSOR- POLEA DE DIST.	
5 CIL. 2.5 L TDI	2009	T43067	TENSOR- POLEA DE DIST.	
5 CIL. 2.5 L TDI	2008	T43067	TENSOR- POLEA DE DIST.	

**CROSSFOX**

4 CIL. 1.6 L	2008	TCK1548	KIT DE DISTRIBUCION	
		TMV-23001	TENSOR MICRO-V	
4 CIL. 1.6 L	2007	TCK1548	KIT DE DISTRIBUCION	
		TMV-23001	TENSOR MICRO-V	
4 CIL. 1.6 L	2006	TCK1548	KIT DE DISTRIBUCION	



4 CIL. 1.6 L	2005	TMV-23001	TENSOR MICRO-V	
		TCK1548	KIT DE DISTRIBUCION	

**DASHER**

4 CIL. 1.6 L Diesel	1981	T41080	TENSOR- POLEA DE DIST.	
---------------------	------	--------	------------------------	--

**DERBY**

4 CIL. 1.8 L	2008	TCK260M	KIT DE DISTRIBUCION	
		T41079	TENSOR- POLEA DE DIST.	
4 CIL. 1.8 L	2007	TCK260M	KIT DE DISTRIBUCION	
		T41079	TENSOR- POLEA DE DIST.	
4 CIL. 1.8 L	2006	TCK260M	KIT DE DISTRIBUCION	
		T41079	TENSOR- POLEA DE DIST.	
4 CIL. 1.8 L	2005	TCK260M	KIT DE DISTRIBUCION	
		T41079	TENSOR- POLEA DE DIST.	

**EUROVAN**

1.9 L DIESEL	2009	TCK333M	KIT DE DISTRIBUCION	
4 CIL. 1.9 L DIESEL	2009	T41229	TENSOR- POLEA DE DIST.	
		T43091	TENSOR- POLEA DE DIST.	
1.9 L DIESEL	2008	TCK333M	KIT DE DISTRIBUCION	
4 CIL. 1.9 L DIESEL	2008	T41229	TENSOR- POLEA DE DIST.	
		T43091	TENSOR- POLEA DE DIST.	
1.9 L DIESEL	2007	TCK333M	KIT DE DISTRIBUCION	
4 CIL. 1.9 L DIESEL	2007	T41229	TENSOR- POLEA DE DIST.	
		T43091	TENSOR- POLEA DE DIST.	
1.9 L DIESEL	2006	TCK333M	KIT DE DISTRIBUCION	
4 CIL. 1.9 L DIESEL	2006	T43091	TENSOR- POLEA DE DIST.	
		T41229	TENSOR- POLEA DE DIST.	
1.9 L DIESEL	2005	TCK333M	KIT DE DISTRIBUCION	
4 CIL. 1.9 L DIESEL	2005	T43091	TENSOR- POLEA DE DIST.	
		T41229	TENSOR- POLEA DE DIST.	
5 CIL. 2.5 L	2005	TPG-22001	TENSOR ARBOL DE LEVAS	
5 CIL. 2.5 L	2004	TCK739M	KIT DE DISTRIBUCION	
		TPG-22001	TENSOR ARBOL DE LEVAS	
5 CIL. 2.5 L	2003	TCK739M	KIT DE DISTRIBUCION	
		TPG-22001	TENSOR ARBOL DE LEVAS	
5 CIL. 2.5 L	2002	TCK739M	KIT DE DISTRIBUCION	
		TPG-22001	TENSOR ARBOL DE LEVAS	
5 CIL. 2.5 L	2001	TCK739M	KIT DE DISTRIBUCION	
		TPG-22001	TENSOR ARBOL DE LEVAS	
5 CIL. 2.5 L	2000	TCK739M	KIT DE DISTRIBUCION	
		TCK739M	KIT DE DISTRIBUCION	
5 CIL. 2.5 L	1996	38079	POLEA	ALT.
		38080	POLEA	ALT.

**GLI**

4 CIL. 2.0 L TURBO	2008	T42019	TENSOR- POLEA DE DIST.	
4 CIL. 2.0 L TURBO	2007	T42019	TENSOR- POLEA DE DIST.	

**GOL**

4 CIL. 1.6 L	2010	TCK1548	KIT DE DISTRIBUCION	
		TPG-23001	TENSOR ARBOL DE LEVAS	
4 CIL. 1.6 L	2009	TCK1548	KIT DE DISTRIBUCION	
		TPG-23001	TENSOR ARBOL DE LEVAS	

**GOLF**

4 CIL. 2.0 L	2008	TCKWP296	KIT DE DISTRIBUCION CON B.A.	
4 CIL. 2.0 L	2007	TCKWP296	KIT DE DISTRIBUCION CON B.A.	
		TCKWP306	KIT DE DISTRIBUCION CON B.A.	
4 CIL. 1.8 L	2006	38148	TENSOR	
		38018	TENSOR	
4 CIL. 2.0 L	2006	T43025	TENSOR- POLEA DE DIST.	HIDRAULICO
		TCK296	KIT DE DISTRIBUCION	
4 CIL. 2.0 L	2006	TCKWP296	KIT DE DISTRIBUCION CON B.A.	
		38148	TENSOR	
		38018	TENSOR	
		T43010	TENSOR- POLEA DE DIST.	

4 CIL. 1.8 L	2005	TCKWP306 38148 38018 T43025	KIT DE DISTRIBUCION CON B.A. TENSOR TENSOR TENSOR- POLEA DE DIST.						
4 CIL. 1.9 L Diesel	2005	T42044 T42050 T43007	TENSOR- POLEA DE DIST. TENSOR- POLEA DE DIST. TENSOR- POLEA DE DIST.	HIDRAULICO POLEA TENSORA POLEA TENSORA	4 CIL. 2.0 L	2000	T42050 T43007 TCK262 TCK296 TCKWP296	TENSOR- POLEA DE DIST. TENSOR- POLEA DE DIST. TENSOR- POLEA DE DIST. TENSOR- POLEA DE DIST. TENSOR- POLEA DE DIST.	POLEA TENSORA POLEA TENSORA
4 CIL. 2.0 L	2005	TCK296 TCKWP296 38018 38148 T43010	KIT DE DISTRIBUCION KIT DE DISTRIBUCION CON B.A. TENSOR TENSOR TENSOR- POLEA DE DIST.				37013P 38148 38018 38147 38087	POLEA DECOPLADORA TENSOR TENSOR TENSOR	S/MicroV doble ALT. Y A.A.
4 CIL. 1.8 L	2004	TCKWP306 38148 38018 T43025	KIT DE DISTRIBUCION CON B.A. TENSOR TENSOR TENSOR- POLEA DE DIST.		V6, 2.8 L 4 CIL. 1.9 L	2000 1999	T41079 T43010 38175 37010P	TENSOR- POLEA DE DIST. TENSOR- POLEA DE DIST. TENSOR POLEA DECOPLADORA	
4 CIL. 1.9 L DIESEL	2004	TCKWP321 T42050 T42044 T43007	KIT DE DISTRIBUCION CON B.A. TENSOR- POLEA DE DIST. TENSOR- POLEA DE DIST. TENSOR- POLEA DE DIST.	HIDRAULICO POLEA TENSORA POLEA TENSORA	4 CIL. 1.9 L DIESEL	1999	TCKWP321 T42044 T42050 T43007	KIT DE DISTRIBUCION CON B.A. TENSOR- POLEA DE DIST. TENSOR- POLEA DE DIST. TENSOR- POLEA DE DIST.	POLEA TENSORA POLEA TENSORA
4 CIL. 2.0 L	2004	TCK296 TCKWP296 38148 38018 T43010	KIT DE DISTRIBUCION KIT DE DISTRIBUCION CON B.A. TENSOR TENSOR TENSOR- POLEA DE DIST.		4 CIL. 2.0 L	1999	TCK296 TCK260M TCK262 TCKWP296 38018 38148	KIT DE DISTRIBUCION KIT DE DISTRIBUCION KIT DE DISTRIBUCION KIT DE DISTRIBUCION CON B.A. TENSOR TENSOR	
4 CIL. 1.8 L	2003	TCKWP306 38018 38148 T43025	KIT DE DISTRIBUCION CON B.A. TENSOR TENSOR TENSOR- POLEA DE DIST.	HIDRAULICO			38147 38087 T43010 T41079	TENSOR TENSOR TENSOR- POLEA DE DIST. TENSOR- POLEA DE DIST.	S/DOBLE MICRO V ALT. Y A.A.
4 CIL. 1.9 L DIESEL	2003	TCKWP321 T42050 T43007 T42044	KIT DE DISTRIBUCION CON B.A. TENSOR- POLEA DE DIST. TENSOR- POLEA DE DIST. TENSOR- POLEA DE DIST.	POLEA TENSORA POLEA TENSORA	V6, 2.8 L 4 CIL. 1.9 L	1999 1998	38175 T43006 T43006	TENSOR TENSOR- POLEA DE DIST. TENSOR- POLEA DE DIST.	CANADA
4 CIL. 2.0 L	2003	TCK296 TCKWP296 37013P 38148 38018 T43010	KIT DE DISTRIBUCION KIT DE DISTRIBUCION CON B.A. POLEA DECOPLADORA TENSOR TENSOR TENSOR- POLEA DE DIST.		4 CIL. 1.9 L Diesel (Canada) 4 CIL. 2.0 L	1998 1998	TCK260M TCK262 38147 38087 T41079 38175	KIT DE DISTRIBUCION KIT DE DISTRIBUCION TENSOR TENSOR TENSOR- POLEA DE DIST. TENSOR	ALT. Y A.A.
4 CIL. 1.8 L	2002	TCKWP306 T43025	KIT DE DISTRIBUCION CON B.A. TENSOR- POLEA DE DIST.	HIDRAULICO	V6, 2.8 L 4 CIL. 1.9 L Diesel (Canada)	1997 1997	T43006 TCK262	TENSOR- POLEA DE DIST. KIT DE DISTRIBUCION	
4 CIL. 1.9 L DIESEL	2002	TCKWP321 T42044 T42050 T43007	KIT DE DISTRIBUCION CON B.A. TENSOR- POLEA DE DIST. TENSOR- POLEA DE DIST. TENSOR- POLEA DE DIST.	POLEA TENSORA POLEA TENSORA	4 CIL. 2.0 L	1997	TCK260M 38147 38087	KIT DE DISTRIBUCION TENSOR TENSOR	ALT. Y A.A.
4 CIL. 2.0 L	2002	TCK296 TCKWP296 37013P 38148 38018 T43010	KIT DE DISTRIBUCION KIT DE DISTRIBUCION CON B.A. POLEA DECOPLADORA TENSOR TENSOR TENSOR- POLEA DE DIST.		4 CIL. 1.9 L Diesel 4 CIL. 2.0 L	1996 1996	T41079 T43006 TCK262 TCK260M 38087 38147	TENSOR- POLEA DE DIST. TENSOR- POLEA DE DIST. KIT DE DISTRIBUCION KIT DE DISTRIBUCION TENSOR TENSOR	ALT. Y A.A.
4 CIL. 1.8 L	2001	TCKWP306 37013P 38148 38018 T43025	KIT DE DISTRIBUCION CON B.A. POLEA DECOPLADORA TENSOR TENSOR TENSOR- POLEA DE DIST.	HIDRAULICO	V6, 2.8 L 4 CIL. 1.8 L 4 CIL. 1.9 L Diesel (Canada)	1996 1995 1995	38175 TCK017 T43006 TCK262	TENSOR KIT DE DISTRIBUCION TENSOR- POLEA DE DIST. KIT DE DISTRIBUCION	CANADA
4 CIL. 1.9 L DIESEL	2001	TCKWP321 T43007 T42050 T42044	KIT DE DISTRIBUCION CON B.A. TENSOR- POLEA DE DIST. TENSOR- POLEA DE DIST. TENSOR- POLEA DE DIST.	POLEA TENSORA POLEA TENSORA	4 CIL. 2.0 L	1995	TCK260M 38147 38087 T41079	KIT DE DISTRIBUCION TENSOR TENSOR TENSOR- POLEA DE DIST.	ALT. Y A.A.
4 CIL. 2.0 L	2001	TCK296 TCKWP296 37013P 38148 38018 T43010	KIT DE DISTRIBUCION KIT DE DISTRIBUCION CON B.A. POLEA DECOPLADORA TENSOR TENSOR TENSOR- POLEA DE DIST.		V6, 2.8 L 4 CIL. 1.9 L Diesel (Canada) 4 CIL. 2.0 L 4 CIL. 1.9 L Diesel (Canada) 4 CIL. 1.6 L Diesel (Canada)	1995 1994 1994 1993 1992	38175 T43006 38147 T43006 38088 T41080 T41080	TENSOR TENSOR- POLEA DE DIST. TENSOR TENSOR- POLEA DE DIST. POLEA TENSOR- POLEA DE DIST.	POLEA LOCA Ail.
4 CIL. 1.8 L	2000	TCKWP306 37013P 38018 38148 T43025	KIT DE DISTRIBUCION CON B.A. POLEA DECOPLADORA TENSOR TENSOR TENSOR- POLEA DE DIST.	HIDRAULICO	4 CIL. 2.0 L 4 CIL. 1.6 L Diesel (Canada)	1992 1991	T41107 38088 T41080 38088 T41080	TENSOR- POLEA DE DIST. POLEA TENSOR- POLEA DE DIST. POLEA TENSOR- POLEA DE DIST.	POLEA LOCA Ail. POLEA LOCA Ail.
4 CIL. 1.9 L DIESEL	2000	TCKWP321	KIT DE DISTRIBUCION CON B.A.		4 CIL. 1.6 L Diesel (Canada)	1989	38088	TENSOR- POLEA DE DIST. POLEA	POLEA LOCA Ail.

4 CIL. 1.6 L Diesel (Canada)	1989	T41080	TENSOR- POLEA DE DIST.	
4 CIL. 1.6 L Diesel (Canada)	1988	38088	POLEA	POLEA LOCA Alt.
		T41080	TENSOR- POLEA DE DIST.	
4 CIL. 1.6 L Diesel	1987	38088	POLEA	POLEA LOCA Alt.
		T41080	TENSOR- POLEA DE DIST.	
4 CIL. 1.6 L Diesel	1986	38088	POLEA	POLEA LOCA Alt.
		T41080	TENSOR- POLEA DE DIST.	
4 CIL. 1.6 L Diesel	1985	38088	POLEA	POLEA LOCA Alt.
		T41080	TENSOR- POLEA DE DIST.	

4 CIL. 1.9 L DIESEL	2004	38148	TENSOR	
		T43025	TENSOR- POLEA DE DIST.	HIDRAULICO
		TCK321	KIT DE DISTRIBUCION	
		37013P	POLEA DECOPLADORA	DECOPLADORA ALTERNADO
		38018	TENSOR	
		38148	TENSOR	CON DOBLE LADO RANURAD
		38192	TENSOR	
4 CIL. 2.0 L	2004	TCK296	KIT DE DISTRIBUCION	
		TCKWP296	KIT DE DISTRIBUCION CON B.A.	
		37013P	POLEA DECOPLADORA	
		38018	TENSOR	
		38148	TENSOR	
		T43010	TENSOR- POLEA DE DIST.	
		38175	TENSOR	P/BANDA DE 7 COSTILLAS
V6, 2.8 L	2004	38175	TENSOR	
4 CIL. 1.8 L	2003	TCKWP306	KIT DE DISTRIBUCION CON B.A.	
		37013P	POLEA DECOPLADORA	
		38018	TENSOR	
		38148	TENSOR	SERP. C/DOBLE PERFIL
		T43025	TENSOR- POLEA DE DIST.	HIDRAULICO
4 CIL. 1.9 L DIESEL	2003	TCK321	KIT DE DISTRIBUCION	
		TCKWP321	KIT DE DISTRIBUCION CON B.A.	
		37013P	POLEA DECOPLADORA	DECOPLADORA ALTERNADO
		38192	TENSOR	
		T42044	TENSOR- POLEA DE DIST.	POLEA TENSORA
		T42050	TENSOR- POLEA DE DIST.	POLEA TENSORA
		T43007	TENSOR- POLEA DE DIST.	
4 CIL. 2.0 L	2003	TCK296	KIT DE DISTRIBUCION	
		TCKWP296	KIT DE DISTRIBUCION CON B.A.	
		37013P	POLEA DECOPLADORA	
		38018	TENSOR	
		38148	TENSOR	SERP. C/DOBLE PERFIL
		T43010	TENSOR- POLEA DE DIST.	
		38175	TENSOR	P/BANDA DE 7 COSTILLAS
V6, 2.8 L	2002	TCKWP306	KIT DE DISTRIBUCION CON B.A.	
4 CIL. 1.8 L	2002	37013P	POLEA DECOPLADORA	
		38148	TENSOR	SERP. C/DOBLE PERFIL
		38018	TENSOR	
		T43025	TENSOR- POLEA DE DIST.	HIDRAULICO
4 CIL. 1.9 L DIESEL	2002	TCK321	KIT DE DISTRIBUCION	
		TCKWP321	KIT DE DISTRIBUCION CON B.A.	
		37013P	POLEA DECOPLADORA	DECOPLADORA ALTERNADO
		37010P	POLEA DECOPLADORA	DECOPLADORA ALTERNADO
		38192	TENSOR	
		T42044	TENSOR- POLEA DE DIST.	POLEA TENSORA
		T43007	TENSOR- POLEA DE DIST.	POLEA TENSORA
		T42050	TENSOR- POLEA DE DIST.	
4 CIL. 2.0 L	2002	TCK296	KIT DE DISTRIBUCION	
		TCKWP296	KIT DE DISTRIBUCION CON B.A.	
		37013P	POLEA DECOPLADORA	
		38148	TENSOR	SERP. C/DOBLE PERFIL
		T43010	TENSOR- POLEA DE DIST.	
		38175	TENSOR	
V6, 2.8 L	2002	38175	TENSOR	
4 CIL. 1.8 L	2001	TCKWP306	KIT DE DISTRIBUCION CON B.A.	
		37013P	POLEA DECOPLADORA	
		38148	TENSOR	SERP. C/DOBLE PERFIL
		38018	TENSOR	
		T43025	TENSOR- POLEA DE DIST.	HIDRAULICO
4 CIL. 1.9 L DIESEL	2001	TCK321	KIT DE DISTRIBUCION	
		TCKWP321	KIT DE DISTRIBUCION CON B.A.	
		37013P	POLEA DECOPLADORA	DECOPLADORA ALTERNADO
		37010P	POLEA DECOPLADORA	DECOPLADORA ALTERNADO
		38192	TENSOR	
		T42050	TENSOR- POLEA DE DIST.	POLEA TENSORA
		T42044	TENSOR- POLEA DE DIST.	POLEA TENSORA
		T43007	TENSOR- POLEA DE DIST.	
4 CIL. 2.0 L	2001	TCK296	KIT DE DISTRIBUCION	
		TCKWP296	KIT DE DISTRIBUCION CON B.A.	
		37013P	POLEA DECOPLADORA	
		38148	TENSOR	SERP. C/DOBLE PERFIL
		38018	TENSOR	
		T43010	TENSOR- POLEA DE DIST.	
V6, 2.8 L	2001	38175	TENSOR	

**GTI**

4 CIL. 2.0 L TURBO	2008	T42019	TENSOR- POLEA DE DIST.	
4 CIL. 2.0 L TURBO	2007	T42019	TENSOR- POLEA DE DIST.	
V6, 2.8 L	2001	38175	TENSOR	
4 CIL. 2.0 L	2000	TCK262	KIT DE DISTRIBUCION	
		38147	TENSOR	S/MicroV doble
V6, 2.8 L	2000	38175	TENSOR	
4 CIL. 2.0 L	1999	TCK262	KIT DE DISTRIBUCION	
		38147	TENSOR	S/MicroV doble
V6, 2.8 L	1999	38175	TENSOR	

**JETTA**

4 CIL. 2.0 L	2010	TCK296	KIT DE DISTRIBUCION	
		38018	TENSOR	CON TURBO
		38148	TENSOR	
4 CIL. 2.0 L	2009	TCK296	KIT DE DISTRIBUCION	
		38148	TENSOR	4 CIL. 2.0 L
		38018	TENSOR	2003
4 CIL. 2.0 L	2008	TCK296	KIT DE DISTRIBUCION	
		TCKWP296	KIT DE DISTRIBUCION CON B.A.	CON TURBO
		38148	TENSOR	
		38018	TENSOR	
1.9 L DIESEL	2007	TCK333M	KIT DE DISTRIBUCION	
4 CIL. 1.9 L DIESEL	2007	38018	TENSOR	V6, 2.8 L
		T41229	TENSOR- POLEA DE DIST.	4 CIL. 1.8 L
		T43091	TENSOR- POLEA DE DIST.	2002
4 CIL. 2.0 L	2007	TCK296	KIT DE DISTRIBUCION	
		TCKWP296	KIT DE DISTRIBUCION CON B.A.	4 CIL. 1.9 L DIESEL
		38148	TENSOR	2002
		38018	TENSOR	
1.9 L DIESEL	2006	TCK333M	KIT DE DISTRIBUCION	
4 CIL. 1.8 L	2006	TCKWP306	KIT DE DISTRIBUCION CON B.A.	
		38018	TENSOR	
		38148	TENSOR	
4 CIL. 1.9 L DIESEL	2006	38018	TENSOR	
		T41229	TENSOR- POLEA DE DIST.	4 CIL. 2.0 L
		T43091	TENSOR- POLEA DE DIST.	2002
4 CIL. 2.0 L	2006	TCK296	KIT DE DISTRIBUCION	
		TCKWP296	KIT DE DISTRIBUCION CON B.A.	
		38148	TENSOR	
		38018	TENSOR	V6, 2.8 L
1.9 L DIESEL	2005	TCK333M	KIT DE DISTRIBUCION	4 CIL. 1.8 L
4 CIL. 1.8 L	2005	TCKWP306	KIT DE DISTRIBUCION CON B.A.	2001
		37013P	POLEA DECOPLADORA	
		38148	TENSOR	
		38018	TENSOR	
		T43025	TENSOR- POLEA DE DIST.	4 CIL. 1.9 L DIESEL
4 CIL. 1.9 L DIESEL	2005	38148	TENSOR	2001
		38018	TENSOR	
		T41229	TENSOR- POLEA DE DIST.	
		T43091	TENSOR- POLEA DE DIST.	
4 CIL. 2.0 L	2005	TCK296	KIT DE DISTRIBUCION	
		TCKWP296	KIT DE DISTRIBUCION CON B.A.	
		37013P	POLEA DECOPLADORA	
		38018	TENSOR	4 CIL. 2.0 L
		38148	TENSOR	2001
		T43010	TENSOR- POLEA DE DIST.	
1.9 L DIESEL	2004	TCK333M	KIT DE DISTRIBUCION	
4 CIL. 1.8 L	2004	TCKWP306	KIT DE DISTRIBUCION CON B.A.	
		37013P	POLEA DECOPLADORA	
		38018	TENSOR	

4 CIL. 1.8 L	2000	TCKWP306	KIT DE DISTRIBUCION CON B.A.			38087	SENSOR	
		37013P	POLEA DECOPLADORA		4 CIL. 1.9 L Diesel (Canada)	1993	T43006	TENSOR- POLEA DE DIST.
		38018	TENSOR	SERP. C/DOBLE PERFIL	4 CIL. 1.6 L Diesel	1992	38088	POLEA
		38148	TENSOR	HIDRAULICO			T41080	TENSOR- POLEA DE DIST.
		T43025	TENSOR- POLEA DE DIST.				T41080	TENSOR- POLEA DE DIST.
4 CIL. 1.9 L DIESEL	2000	TCK321	KIT DE DISTRIBUCION		4 CIL. 2.0 L	1992	T41107	TENSOR- POLEA DE DIST.
		TCKWP321	KIT DE DISTRIBUCION CON B.A.		4 CIL. 1.6 L Diesel	1991	38088	POLEA
		37010P	POLEA DECOPLADORA	DECOPLADORA ALTERNADOF			T41080	TENSOR- POLEA DE DIST.
		37013P	POLEA DECOPLADORA	DECOPLADORA ALTERNADOF	4 CIL. 1.6 L Diesel	1990	38088	POLEA
		38192	TENSOR				T41080	TENSOR- POLEA DE DIST.
		T43007	TENSOR- POLEA DE DIST.		4 CIL. 1.6 L Diesel	1989	38088	POLEA
		T42050	TENSOR- POLEA DE DIST.	POLEA TENSORA			T41080	TENSOR- POLEA DE DIST.
		T42044	TENSOR- POLEA DE DIST.	POLEA TENSORA	4 CIL. 1.6 L Diesel (Canada)	1988	38088	POLEA
4 CIL. 2.0 L	2000	TCK296	KIT DE DISTRIBUCION				T41080	TENSOR- POLEA DE DIST.
		TCK262	KIT DE DISTRIBUCION		4 CIL. 1.6 L Diesel (Canada)	1987	38088	POLEA
		TCK260M	KIT DE DISTRIBUCION				T41080	TENSOR- POLEA DE DIST.
		TCKWP296	KIT DE DISTRIBUCION CON B.A.		4 CIL. 1.6 L Diesel	1986	38088	POLEA
		37013P	POLEA DECOPLADORA				T41080	TENSOR- POLEA DE DIST.
		38018	TENSOR		4 CIL. 1.6 L Diesel	1985	38088	POLEA
		38147	TENSOR	ALT. Y.A.A.			T41080	TENSOR- POLEA DE DIST.
		38087	TENSOR	ALT. Y.A.A.	4 CIL. 1.6 L Diesel	1984	T41080	TENSOR- POLEA DE DIST.
		38148	TENSOR	SERP. C/DOBLE PERFIL	4 CIL. 1.6 L Diesel	1983	T41080	TENSOR- POLEA DE DIST.
		T41079	TENSOR- POLEA DE DIST.		4 CIL. 1.6 L Diesel	1982	T41080	TENSOR- POLEA DE DIST.
		T43010	TENSOR- POLEA DE DIST.		4 CIL. 1.6 L Diesel	1981	T41080	TENSOR- POLEA DE DIST.
V6, 2.8 L	2000	38175	TENSOR					
4 CIL. 1.9 L DIESEL	1999	TCKWP321	KIT DE DISTRIBUCION CON B.A.					
		T43007	TENSOR- POLEA DE DIST.					
		T42044	TENSOR- POLEA DE DIST.	POLEA TENSORA	4 CIL. 1.6 L	2008	TCK1548	KIT DE DISTRIBUCION
		T42050	TENSOR- POLEA DE DIST.	POLEA TENSORA			TPG-23001	TENSOR ARBOL DE LEVAS
4 CIL. 2.0 L	1999	TCK260M	KIT DE DISTRIBUCION		4 CIL. 1.6 L	2007	TMV-23001	TENSOR MICRO-V
		TCK262	KIT DE DISTRIBUCION				TCK1548	KIT DE DISTRIBUCION
		TCK296	KIT DE DISTRIBUCION				TPG-23001	TENSOR ARBOL DE LEVAS
		TCKWP296	KIT DE DISTRIBUCION CON B.A.		4 CIL. 1.6 L	2006	TMV-23001	TENSOR MICRO-V
		37013P	POLEA DECOPLADORA				TCK1548	KIT DE DISTRIBUCION
		38087	TENSOR	ALT. Y.A.A.	4 CIL. 1.6 L	2005	TPG-23001	TENSOR ARBOL DE LEVAS
		38147	TENSOR	ALT. Y.A.A.			TMV-23001	TENSOR MICRO-V
		38148	TENSOR	SERP. C/DOBLE PERFIL	4 CIL. 1.6 L	2004	TCK1548	KIT DE DISTRIBUCION
		38018	TENSOR				TPG-23001	TENSOR ARBOL DE LEVAS
		T41079	TENSOR- POLEA DE DIST.				TMV-23001	TENSOR MICRO-V
V6, 2.8 L	1999	T43010	TENSOR- POLEA DE DIST.		4 CIL. 1.6 L	2004	TMV-23001	TENSOR MICRO-V
4 CIL. 1.9 L DIESEL	1998	38175	TENSOR				TCK1548	KIT DE DISTRIBUCION
4 CIL. 2.0 L	1998	T43006	TENSOR- POLEA DE DIST.				TPG-23001	TENSOR ARBOL DE LEVAS
		TCK262	KIT DE DISTRIBUCION				TMV-23001	TENSOR MICRO-V
		TCK260M	KIT DE DISTRIBUCION					
		38147	TENSOR					
		38087	TENSOR	ALT.	4 CIL. 1.8 L	2001	TMV-22002	TENSOR MICRO-V
		T41079	TENSOR- POLEA DE DIST.				TMV-22001	TENSOR MICRO-V
V6, 2.8 L	1998	38175	TENSOR				TMV-22002	TENSOR MICRO-V
4 CIL. 1.9 L DIESEL	1997	T43006	TENSOR- POLEA DE DIST.		4 CIL. 1.8 L	2000	TMV-22001	TENSOR- POLEA DE DIST.
4 CIL. 2.0 L	1997	TCK262	KIT DE DISTRIBUCION				TMV-22002	TENSOR MICRO-V
		TCK260M	KIT DE DISTRIBUCION		4 CIL. 1.8 L	1999	TMV-22002	TENSOR MICRO-V
		38087	TENSOR	ALT.			TMV-22001	TENSOR MICRO-V
		38147	TENSOR		4 CIL. 1.8 L	1998	TMV-22001	TENSOR MICRO-V
		T41079	TENSOR- POLEA DE DIST.				TMV-22002	TENSOR MICRO-V
V6, 2.8 L	1997	38175	TENSOR					
4 CIL. 1.9 L DIESEL	1996	T43006	TENSOR- POLEA DE DIST.					
4 CIL. 2.0 L	1996	TCK262	KIT DE DISTRIBUCION					
		TCK260M	KIT DE DISTRIBUCION					
		38147	TENSOR					
		38087	TENSOR	ALT.	4 CIL. 2.0 L	2008	38018	TENSOR
		T41079	TENSOR- POLEA DE DIST.		4 CIL. 2.0 L	2007	38018	TENSOR
V6, 2.8 L	1996	38175	TENSOR		4 CIL. 2.0 L	2006	38148	TENSOR
4 CIL. 1.8 L	1995	TCK017	KIT DE DISTRIBUCION	CANADA			38018	TENSOR
4 CIL. 1.9 L Diesel (Canada)	1995	T43006	TENSOR- POLEA DE DIST.		4 CIL. 1.8 L	2005	TCKWP306A	KIT DE DISTRIBUCION CON B.A.
4 CIL. 2.0 L	1995	TCK260M	KIT DE DISTRIBUCION				38151	TENSOR
		TCK262	KIT DE DISTRIBUCION				38068	TENSOR
		38087	TENSOR	ALT.	4 CIL. 1.8 L	2005	T43028	TENSOR- POLEA DE DIST.
		38147	TENSOR				T43018	TENSOR- POLEA DE DIST.
		T41079	TENSOR- POLEA DE DIST.		V6, 2.8 L	2005	TCKWP297	KIT DE DISTRIBUCION CON B.A.
V6, 2.8 L	1995	38175	TENSOR				38193	TENSOR
4 CIL. 1.8 L	1995	TCK017	KIT DE DISTRIBUCION				T43026	TENSOR- POLEA DE DIST.
4 CIL. 1.9 L Diesel (Canada)	1994	T43006	TENSOR- POLEA DE DIST.				T41227	TENSOR- POLEA DE DIST.
4 CIL. 2.0 L	1994	38147	TENSOR		4 CIL. 1.8 L	2004	T41082	TENSOR- POLEA DE DIST.
							TCKWP306A	KIT DE DISTRIBUCION CON B.A.

### LUPO

4 CIL. 1.6 L	2008	TCK1548	KIT DE DISTRIBUCION	
		TPG-23001	TENSOR ARBOL DE LEVAS	
		TMV-23001	TENSOR MICRO-V	
4 CIL. 1.6 L	2007	TCK1548	KIT DE DISTRIBUCION	
		TPG-23001	TENSOR ARBOL DE LEVAS	
		TMV-23001	TENSOR MICRO-V	
4 CIL. 1.6 L	2006	TCK1548	KIT DE DISTRIBUCION	
		TPG-23001	TENSOR ARBOL DE LEVAS	
		TMV-23001	TENSOR MICRO-V	
4 CIL. 1.6 L	2005	TCK1548	KIT DE DISTRIBUCION	
		TPG-23001	TENSOR ARBOL DE LEVAS	
		TMV-23001	TENSOR MICRO-V	
4 CIL. 1.6 L	2004	TCK1548	KIT DE DISTRIBUCION	
		TPG-23001	TENSOR ARBOL DE LEVAS	
		TMV-23001	TENSOR MICRO-V	

### PANEL

4 CIL. 1.8 L	2001	TMV-22002	TENSOR MICRO-V	S/AA, C/DH
		TMV-22001	TENSOR MICRO-V	C/AA, C/DH
		TMV-22002	TENSOR MICRO-V	S/AA, C/DH
		TMV-22001	TENSOR- POLEA DE DIST.	C/AA, C/DH
4 CIL. 1.8 L	2000	TMV-22001	TENSOR MICRO-V	C/AA, C/DH
		TMV-22002	TENSOR MICRO-V	S/AA, C/DH
4 CIL. 1.8 L	1999	TMV-22002	TENSOR MICRO-V	S/AA, C/DH
		TMV-22001	TENSOR MICRO-V	C/AA, C/DH
4 CIL. 1.8 L	1998	TMV-22001	TENSOR MICRO-V	C/AA, C/DH
		TMV-22002	TENSOR MICRO-V	S/AA, C/DH

### PASSAT

4 CIL. 2.0 L	2008	38018	TENSOR	
4 CIL. 2.0 L	2007	38018	TENSOR	
4 CIL. 2.0 L	2006	38148	TENSOR	
		38018	TENSOR	
4 CIL. 1.8 L	2005	TCKWP306A	KIT DE DISTRIBUCION CON B.A.	
		38151	TENSOR	
		38068	TENSOR	LOCA
		T43028	TENSOR- POLEA DE DIST.	HIDRAULICO
		T43018	TENSOR- POLEA DE DIST.	
V6, 2.8 L	2005	TCKWP297	KIT DE DISTRIBUCION CON B.A.	
		38193	TENSOR	
		T43026	TENSOR- POLEA DE DIST.	HIDRAULICO
		T41227	TENSOR- POLEA DE DIST.	POLEA TENSORA
		T41082	TENSOR- POLEA DE DIST.	
4 CIL. 1.8 L	2004	TCKWP306A	KIT DE DISTRIBUCION CON B.A.	



4 CIL. 1.8 L	2004	38068 38151 T43028 T43018	TENSOR TENSOR TENSOR- POLEA DE DIST. TENSOR- POLEA DE DIST.	A.A. HIDRAULICO					
V6, 2.8 L	2004	TCKWP297 38193 T43026 T41082 T41227	KIT DE DISTRIBUCION CON B.A. TENSOR TENSOR- POLEA DE DIST. TENSOR- POLEA DE DIST. TENSOR- POLEA DE DIST.	HIDRAULICO POLEA TENSORA	V6, 2.8 L 4 CIL. 1.9 L Diesel (Canada) 4 CIL. 2.0 L	1996 1995 1995	TCK260M 38087 38147 T41079 38175 T43006 TCK260M	KIT DE DISTRIBUCION TENSOR TENSOR TENSOR- POLEA DE DIST. TENSOR- POLEA DE DIST. KIT DE DISTRIBUCION	ALT. Y.A.A. ALT. Y.A.A.
4 CIL. 1.8 L	2003	TCKWP306A 38068 38151 T43018 T43028	KIT DE DISTRIBUCION CON B.A. TENSOR TENSOR TENSOR- POLEA DE DIST. TENSOR- POLEA DE DIST.	A.A. HIDRAULICO	V6, 2.8 L 4 CIL. 1.9 L Diesel (Canada) 4 CIL. 2.0 L	1995 1994 1994	TCK262 38147 38087 T41079 38175 T43006 38147	KIT DE DISTRIBUCION TENSOR TENSOR TENSOR- POLEA DE DIST. TENSOR- POLEA DE DIST. TENSOR	ALT. Y.A.A.
V6, 2.8 L	2003	TCKWP297 38193 T41082 T43026 T41227	KIT DE DISTRIBUCION CON B.A. TENSOR TENSOR- POLEA DE DIST. TENSOR- POLEA DE DIST. TENSOR- POLEA DE DIST.	HIDRAULICO POLEA TENSORA	4 CIL. 2.0 L (Canada) 4 CIL. 1.9 L Diesel (Canada) 4 CIL. 2.0 L	1994 1993 1993	38088 T43006 38088 38147 38088	POLEA TENSOR- POLEA DE DIST. POLEA TENSOR POLEA	POLEA LOCA A.A. Brkt. POLEA LOCA A.A. Brkt. POLEA LOCA A.A. Brkt.
4 CIL. 1.8 L	2002	TCKWP306A 38151 38068 T43028 T43018	KIT DE DISTRIBUCION CON B.A. TENSOR TENSOR TENSOR- POLEA DE DIST. TENSOR- POLEA DE DIST.	A.A. HIDRAULICO	4 CIL. 2.0 L	1992	T41107	TENSOR- POLEA DE DIST.	
V6, 2.8 L	2002	TCKWP297 38193 T43026 T41227 T41082	KIT DE DISTRIBUCION CON B.A. TENSOR TENSOR- POLEA DE DIST. TENSOR- POLEA DE DIST. TENSOR- POLEA DE DIST.	HIDRAULICO POLEA TENSORA	4 CIL. 1.8 L	2008	TCK260M TCKWP260 TMV-22002 TMV-22001 T41079	KIT DE DISTRIBUCION KIT DE DISTRIBUCION CON B.A. TENSOR MICRO-V TENSOR MICRO-V TENSOR- POLEA DE DIST.	S/AA C/AA
4 CIL. 1.8 L	2001	TCKWP306A 38068 38151 T43028	KIT DE DISTRIBUCION CON B.A. TENSOR TENSOR TENSOR- POLEA DE DIST.	A.A. HIDRAULICO	4 CIL. 1.8 L	2007	TCK260M TCKWP260 TMV-22001 TMV-22002 T41079	KIT DE DISTRIBUCION KIT DE DISTRIBUCION CON B.A. TENSOR MICRO-V TENSOR MICRO-V TENSOR- POLEA DE DIST.	C/AA S/AA
V6, 2.8 L	2001	TCKWP297 38193 T41227 T41082 T43026	KIT DE DISTRIBUCION CON B.A. TENSOR TENSOR- POLEA DE DIST. TENSOR- POLEA DE DIST. TENSOR- POLEA DE DIST.	POLEA TENSORA HIDRAULICO	4 CIL. 1.8 L	2006	TCK260M TCKWP260 TMV-22001 TMV-22002 T41079	KIT DE DISTRIBUCION KIT DE DISTRIBUCION CON B.A. TENSOR MICRO-V TENSOR MICRO-V TENSOR- POLEA DE DIST.	C/AA S/AA
4 CIL. 1.8 L	2000	38068 38151 T43066 T43065 T42044 T43025	TENSOR TENSOR TENSOR- POLEA DE DIST. TENSOR- POLEA DE DIST. TENSOR- POLEA DE DIST. TENSOR- POLEA DE DIST.	A.A. HIDRAULICO	4 CIL. 2.0 L 4 CIL. 1.8 L	2006 2005	TMV-22002 TMV-22001 TCK260M TCKWP260 TMV-22002 TMV-22001 T41079	TENSOR MICRO-V TENSOR MICRO-V KIT DE DISTRIBUCION KIT DE DISTRIBUCION CON B.A. TENSOR MICRO-V TENSOR MICRO-V TENSOR- POLEA DE DIST.	S/AA, C/DH C/AA, C/DH
V6, 2.8 L	2000	TCKWP297 38193 T43026 T41227 T41082	KIT DE DISTRIBUCION CON B.A. TENSOR TENSOR- POLEA DE DIST. TENSOR- POLEA DE DIST. TENSOR- POLEA DE DIST.	POLEA TENSORA HIDRAULICO POLEA TENSORA	4 CIL. 2.0 L 4 CIL. 1.8 L	2005 2004	TMV-22001 TMV-22002 TCK260M TCKWP260 TMV-22002 TMV-22001 T41079	TENSOR MICRO-V TENSOR MICRO-V KIT DE DISTRIBUCION KIT DE DISTRIBUCION CON B.A. TENSOR MICRO-V TENSOR MICRO-V TENSOR- POLEA DE DIST.	S/AA, C/DH C/AA, C/DH
4 CIL. 1.8 L	1999	38151 38068 T43065 T43066 T42044	TENSOR TENSOR TENSOR- POLEA DE DIST. TENSOR- POLEA DE DIST. TENSOR- POLEA DE DIST.	A.A. HIDRAULICO POLEA TENSORA	4 CIL. 2.0 L 4 CIL. 1.8 L	2004 2003	TMV-22001 TMV-22002 TCK260M TCKWP260 TMV-22001 TMV-22002 T41079	TENSOR MICRO-V TENSOR MICRO-V KIT DE DISTRIBUCION KIT DE DISTRIBUCION CON B.A. TENSOR MICRO-V TENSOR MICRO-V TENSOR- POLEA DE DIST.	S/AA, C/DH C/AA, C/DH
V6, 2.8 L	1999	TCKWP297 38193 T41227 T41082 T43026	KIT DE DISTRIBUCION CON B.A. TENSOR TENSOR- POLEA DE DIST. TENSOR- POLEA DE DIST. TENSOR- POLEA DE DIST.	POLEA TENSORA HIDRAULICO POLEA TENSORA	4 CIL. 2.0 L 4 CIL. 1.8 L	2003 2002	TCK260M TCKWP260 TMV-22001 TMV-22002 T41079	KIT DE DISTRIBUCION KIT DE DISTRIBUCION CON B.A. TENSOR MICRO-V TENSOR MICRO-V TENSOR- POLEA DE DIST.	S/AA, C/DH C/AA, C/DH
4 CIL. 1.8 L	1998	T42044 T43065 T43066	TENSOR- POLEA DE DIST. TENSOR- POLEA DE DIST. TENSOR- POLEA DE DIST.	POLEA TENSORA HIDRAULICO	4 CIL. 2.0 L 4 CIL. 1.8 L	2003 2002	TMV-22001 TMV-22002 TCK260M TCKWP260 TMV-22001 TMV-22002 T41079	TENSOR MICRO-V TENSOR MICRO-V KIT DE DISTRIBUCION KIT DE DISTRIBUCION CON B.A. TENSOR MICRO-V TENSOR MICRO-V TENSOR- POLEA DE DIST.	S/AA, C/DH S/AA, C/DH
4 CIL. 1.9 L Diesel	1998	T43006	TENSOR- POLEA DE DIST.	HIDRAULICO	4 CIL. 1.8 L	2002	TCK260M TCKWP260 TMV-22002 TMV-22001 T41079	KIT DE DISTRIBUCION KIT DE DISTRIBUCION CON B.A. TENSOR MICRO-V TENSOR MICRO-V TENSOR- POLEA DE DIST.	S/AA, C/DH C/AA, C/DH
V6, 2.8 L	1998	TCKWP297 38193 T41082 T41227 T43026	KIT DE DISTRIBUCION CON B.A. TENSOR TENSOR- POLEA DE DIST. TENSOR- POLEA DE DIST. TENSOR- POLEA DE DIST.	POLEA TENSORA HIDRAULICO	4 CIL. 2.0 L 4 CIL. 1.8 L	2002 2001	TMV-22002 TMV-22001 TCK260M TCKWP260 TMV-22001 TMV-22002 T41079	TENSOR MICRO-V TENSOR MICRO-V KIT DE DISTRIBUCION KIT DE DISTRIBUCION CON B.A. TENSOR MICRO-V TENSOR MICRO-V TENSOR- POLEA DE DIST.	S/AA, C/DH C/AA, C/DH
4 CIL. 1.9 L Diesel	1997	T43006	TENSOR- POLEA DE DIST.	HIDRAULICO	4 CIL. 1.8 L	2001	TCK260M TCKWP260 TMV-22001 TMV-22002 T41079	KIT DE DISTRIBUCION KIT DE DISTRIBUCION CON B.A. TENSOR MICRO-V TENSOR MICRO-V TENSOR- POLEA DE DIST.	S/AA, C/DH C/AA, C/DH
V6, 2.8 L	1997	38175	TENSOR						
4 CIL. 1.9 L Diesel	1996	T43006	TENSOR- POLEA DE DIST.						
4 CIL. 2.0 L	1996	TCK262	KIT DE DISTRIBUCION						

### POINTER

4 CIL. 1.8 L	2008	TCK260M TCKWP260 TMV-22002 TMV-22001 T41079	KIT DE DISTRIBUCION KIT DE DISTRIBUCION CON B.A. TENSOR MICRO-V TENSOR MICRO-V TENSOR- POLEA DE DIST.	S/AA C/AA
4 CIL. 1.8 L	2007	TCK260M TCKWP260 TMV-22001 TMV-22002 T41079	KIT DE DISTRIBUCION KIT DE DISTRIBUCION CON B.A. TENSOR MICRO-V TENSOR MICRO-V TENSOR- POLEA DE DIST.	C/AA S/AA
4 CIL. 1.8 L	2006	TCK260M TCKWP260 TMV-22001 TMV-22002 T41079	KIT DE DISTRIBUCION KIT DE DISTRIBUCION CON B.A. TENSOR MICRO-V TENSOR MICRO-V TENSOR- POLEA DE DIST.	C/AA S/AA
4 CIL. 2.0 L	2006	TMV-22002 TMV-22001	TENSOR MICRO-V TENSOR MICRO-V	S/AA, C/DH C/AA, C/DH
4 CIL. 1.8 L	2005	TCK260M TCKWP260 TMV-22002 TMV-22001 T41079	KIT DE DISTRIBUCION KIT DE DISTRIBUCION CON B.A. TENSOR MICRO-V TENSOR MICRO-V TENSOR- POLEA DE DIST.	S/AA, C/DH C/AA, C/DH
4 CIL. 2.0 L	2005	TMV-22001 TMV-22002	TENSOR MICRO-V TENSOR MICRO-V	S/AA, C/DH C/AA, C/DH
4 CIL. 1.8 L	2004	TCK260M TCKWP260 TMV-22002 TMV-22001 T41079	KIT DE DISTRIBUCION KIT DE DISTRIBUCION CON B.A. TENSOR MICRO-V TENSOR MICRO-V TENSOR- POLEA DE DIST.	S/AA, C/DH C/AA, C/DH
4 CIL. 2.0 L	2004	TMV-22001 TMV-22002	TENSOR MICRO-V TENSOR MICRO-V	S/AA, C/DH C/AA, C/DH
4 CIL. 1.8 L	2003	TCK260M TCKWP260 TMV-22001 TMV-22002 T41079	KIT DE DISTRIBUCION KIT DE DISTRIBUCION CON B.A. TENSOR MICRO-V TENSOR MICRO-V TENSOR- POLEA DE DIST.	S/AA, C/DH C/AA, C/DH
4 CIL. 2.0 L	2003	TMV-22001 TMV-22002	TENSOR MICRO-V TENSOR MICRO-V	S/AA, C/DH S/AA, C/DH
4 CIL. 1.8 L	2002	TCK260M TCKWP260 TMV-22001 TMV-22002 T41079	KIT DE DISTRIBUCION KIT DE DISTRIBUCION CON B.A. TENSOR MICRO-V TENSOR MICRO-V TENSOR- POLEA DE DIST.	S/AA, C/DH C/AA, C/DH
4 CIL. 2.0 L	2002	TMV-22001 TMV-22002	TENSOR MICRO-V TENSOR MICRO-V	S/AA, C/DH C/AA, C/DH
4 CIL. 1.8 L	2001	TCK260M TCKWP260 TMV-22001 TMV-22002 T41079	KIT DE DISTRIBUCION KIT DE DISTRIBUCION CON B.A. TENSOR MICRO-V TENSOR MICRO-V TENSOR- POLEA DE DIST.	S/AA, C/DH C/AA, C/DH

4 CIL. 2.0 L	2001	TMV-22002	SENSOR MICRO-V	S/AA, C/DH
		TMV-22001	SENSOR MICRO-V	C/AA, C/DH
4 CIL. 1.8 L	2000	TCK260M	KIT DE DISTRIBUCION	
		TCKWP260	KIT DE DISTRIBUCION CON B.A.	
		TMV-22001	SENSOR MICRO-V	C/AA, C/DH
		TMV-22002	SENSOR MICRO-V	S/AA, C/DH
		T41079	SENSOR- POLEA DE DIST.	
4 CIL. 2.0 L	2000	TMV-22002	SENSOR MICRO-V	S/AA, C/DH
		TMV-22001	SENSOR MICRO-V	C/AA, C/DH
4 CIL. 1.8 L	1999	TCK260M	KIT DE DISTRIBUCION	
		TCKWP260	KIT DE DISTRIBUCION CON B.A.	
		TMV-22002	SENSOR MICRO-V	S/AA, C/DH
		TMV-22001	SENSOR MICRO-V	C/AA, C/DH
		T41079	SENSOR- POLEA DE DIST.	
4 CIL. 2.0 L	1999	TMV-22001	SENSOR MICRO-V	C/AA, C/DH
		TMV-22002	SENSOR MICRO-V	S/AA, C/DH
4 CIL. 1.8 L	1998	TCK260M	KIT DE DISTRIBUCION	
		TCKWP260	KIT DE DISTRIBUCION CON B.A.	
		TMV-22002	SENSOR MICRO-V	S/AA, C/DH
		TMV-22001	SENSOR MICRO-V	C/AA, C/DH
		T41079	SENSOR- POLEA DE DIST.	
4 CIL. 2.0 L	1998	TMV-22001	SENSOR MICRO-V	C/AA, C/DH
		TMV-22002	SENSOR MICRO-V	S/AA, C/DH

### POINTER PICK-UP

4 CIL. 1.8 L	2005	TMV-22002	SENSOR MICRO-V	S/AA, C/DH
		TMV-22001	SENSOR MICRO-V	C/AA, C/DH
4 CIL. 1.8 L	2004	TMV-22002	SENSOR MICRO-V	S/AA, C/DH
		TMV-22001	SENSOR MICRO-V	C/AA, C/DH
4 CIL. 1.8 L	2003	TMV-22002	SENSOR MICRO-V	S/AA, C/DH
		TMV-22001	SENSOR MICRO-V	C/AA, C/DH
4 CIL. 1.8 L	2002	TMV-22001	SENSOR MICRO-V	C/AA, C/DH
		TMV-22002	SENSOR MICRO-V	S/AA, C/DH
4 CIL. 1.8 L	2001	TMV-22002	SENSOR MICRO-V	S/AA, C/DH
		TMV-22001	SENSOR MICRO-V	C/AA, C/DH
4 CIL. 1.8 L	2000	TMV-22001	SENSOR MICRO-V	C/AA, C/DH
		TMV-22002	SENSOR MICRO-V	S/AA, C/DH
4 CIL. 1.8 L	1999	TMV-22001	SENSOR MICRO-V	C/AA, C/DH
		TMV-22002	SENSOR MICRO-V	S/AA, C/DH
4 CIL. 1.8 L	1998	TMV-22002	SENSOR MICRO-V	S/AA, C/DH
		TMV-22001	SENSOR MICRO-V	C/AA, C/DH

### POLO

4 CIL. 1.6 L	2007	TCK1548	KIT DE DISTRIBUCION	
		TPG-23001	SENSOR ARBOL DE LEVAS	
		TMV-23001	SENSOR MICRO-V	
4 CIL. 1.6 L	2006	TCK1548	KIT DE DISTRIBUCION	
		TPG-23001	SENSOR ARBOL DE LEVAS	
		TMV-23001	SENSOR MICRO-V	
4 CIL. 1.6 L	2005	TCK1548	KIT DE DISTRIBUCION	
		TPG-23001	SENSOR ARBOL DE LEVAS	
		TMV-23001	SENSOR MICRO-V	
4 CIL. 1.6 L	2004	TPG-23001	SENSOR ARBOL DE LEVAS	
		TMV-23001	SENSOR MICRO-V	
4 CIL. 1.6 L	2003	TPG-23001	SENSOR ARBOL DE LEVAS	
		TMV-23001	SENSOR MICRO-V	

### QUANTUM

4 CIL. 1.6 L Diesel	1985	T41080	SENSOR- POLEA DE DIST.	
4 CIL. 1.6 L Diesel	1984	T41080	SENSOR- POLEA DE DIST.	
4 CIL. 1.6 L Diesel	1983	T41080	SENSOR- POLEA DE DIST.	
4 CIL. 1.6 L Diesel	1982	T41080	SENSOR- POLEA DE DIST.	

### RABBIT

4 CIL. 1.6 L Diesel	1984	T41080	SENSOR- POLEA DE DIST.	
4 CIL. 1.6 L Diesel	1983	T41080	SENSOR- POLEA DE DIST.	
4 CIL. 1.6 L Diesel	1982	T41080	SENSOR- POLEA DE DIST.	
4 CIL. 1.6 L Diesel	1981	T41080	SENSOR- POLEA DE DIST.	

<b>RABBIT PICKUP</b>				
4 CIL. 1.6 L Diesel	1983	T41080	SENSOR- POLEA DE DIST.	
4 CIL. 1.6 L Diesel	1982	T41080	SENSOR- POLEA DE DIST.	
4 CIL. 1.6 L Diesel	1981	T41080	SENSOR- POLEA DE DIST.	

### ROUTAN

4 CIL. 1.6 L Diesel	2010	36313	POLEA	
		38323	SENSOR	
		38018	SENSOR	
4 CIL. 1.6 L Diesel	2009	36313	POLEA	
		38018	SENSOR	
		38323	SENSOR	

### SAVEIRO

4 CIL. 1.6 L	2010	TCK1548	KIT DE DISTRIBUCION	
		TPG-23001	SENSOR ARBOL DE LEVAS	

### SHARAN

4 CIL. 1.8 L	2007	38148	SENSOR	
		T43016	SENSOR- POLEA DE DIST.	
		T43017	SENSOR- POLEA DE DIST.	CON TORNILLO
4 CIL. 1.8 L	2006	38148	SENSOR	
		T43017	SENSOR- POLEA DE DIST.	CON TORNILLO
		T43016	SENSOR- POLEA DE DIST.	
4 CIL. 1.8 L	2005	38148	SENSOR	
		T43017	SENSOR- POLEA DE DIST.	CON TORNILLO
		T43016	SENSOR- POLEA DE DIST.	
4 CIL. 1.8 L	2004	38148	SENSOR	
		T43017	SENSOR- POLEA DE DIST.	CON TORNILLO
		T43016	SENSOR- POLEA DE DIST.	
4 CIL. 1.8 L	2003	38148	SENSOR	
		T43016	SENSOR- POLEA DE DIST.	
		T43017	SENSOR- POLEA DE DIST.	CON TORNILLO

### SPORTVAN

4 CIL. 1.6 L	2008	TCK1548	KIT DE DISTRIBUCION	
		TMV-23001	SENSOR MICRO-V	
4 CIL. 1.6 L	2007	TCK1548	KIT DE DISTRIBUCION	
		TMV-23001	SENSOR MICRO-V	
4 CIL. 1.6 L	2006	TCK1548	KIT DE DISTRIBUCION	
		TMV-23001	SENSOR MICRO-V	

### TOUAREG

4 CIL. 1.6 L Diesel	2010	T42044	SENSOR- POLEA DE DIST.	
4 CIL. 1.6 L Diesel	2009	T42044	SENSOR- POLEA DE DIST.	
4 CIL. 1.6 L Diesel	2008	38317	SENSOR	
4 CIL. 1.6 L Diesel	2007	38317	SENSOR	
4 CIL. 1.6 L Diesel	2006	38317	SENSOR	
4 CIL. 1.6 L Diesel	2006	TCKWP297A	KIT DE DISTRIBUCION CON B.A.	
		T41230	SENSOR- POLEA DE DIST.	SUP.
		T41228	SENSOR- POLEA DE DIST.	INF.
		T43032	SENSOR- POLEA DE DIST.	HIDRAULICO
		T41228	SENSOR- POLEA DE DIST.	INF.
		T43032	SENSOR- POLEA DE DIST.	HIDRAULICO
		T41098	SENSOR- POLEA DE DIST.	
		T41230	SENSOR- POLEA DE DIST.	SUP.
		T41098	SENSOR- POLEA DE DIST.	
4 CIL. 1.6 L Diesel	2005	TCKWP297A	KIT DE DISTRIBUCION CON B.A.	
4 CIL. 1.6 L Diesel	2004	TCKWP297A	KIT DE DISTRIBUCION CON B.A.	

### VANAGON

4 CIL. 1.6 L Diesel	1983	T41080	SENSOR- POLEA DE DIST.	
4 CIL. 1.6 L Diesel	1982	T41080	SENSOR- POLEA DE DIST.	

### VW VAN

4 CIL. 1.6 L	2006	TMV-23001	SENSOR MICRO-V	
--------------	------	-----------	----------------	--

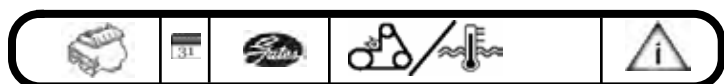

4 CIL. 1.6 L	2005	TPG-23001	TENSOR ARBOL DE LEVAS
		TMV-23001	TENSOR MICRO-V
4 CIL. 1.6 L	2004	TPG-23001	TENSOR ARBOL DE LEVAS
		TMV-23001	TENSOR MICRO-V
4 CIL. 1.6 L	2003	TPG-23001	TENSOR ARBOL DE LEVAS
		TMV-23001	TENSOR MICRO-V

## VOLVO

### 240

4 CIL. 2.3 L	1992	T41081	TENSOR- POLEA DE DIST.
4 CIL. 2.3 L	1991	T41081	TENSOR- POLEA DE DIST.
4 CIL. 2.3 L	1990	T41081	TENSOR- POLEA DE DIST.
4 CIL. 2.3 L	1989	T41081	TENSOR- POLEA DE DIST.
4 CIL. 2.3 L	1988	T41081	TENSOR- POLEA DE DIST.
4 CIL. 2.3 L	1987	T41081	TENSOR- POLEA DE DIST.
4 CIL. 2.3 L	1986	T41081	TENSOR- POLEA DE DIST.
4 CIL. 2.1 L	1985	T41081	TENSOR- POLEA DE DIST.
4 CIL. 2.3 L	1985	T41081	TENSOR- POLEA DE DIST.
4 CIL. 2.1 L	1984	T41081	TENSOR- POLEA DE DIST.
4 CIL. 2.1 L	1983	T41081	TENSOR- POLEA DE DIST.
4 CIL. 2.3 L	1983	T41081	TENSOR- POLEA DE DIST.
4 CIL. 2.1 L	1982	T41081	TENSOR- POLEA DE DIST.
4 CIL. 2.3 L (Canada)	1982	T41081	TENSOR- POLEA DE DIST.
4 CIL. 2.1 L	1981	T41081	TENSOR- POLEA DE DIST.

### 260

4 CIL. 2.1 L	1981	T41081	TENSOR- POLEA DE DIST.
--------------	------	--------	------------------------

### 740

4 CIL. 2.3 L	1992	T41081	TENSOR- POLEA DE DIST.
4 CIL. 2.3 L	1991	T41081	TENSOR- POLEA DE DIST.
4 CIL. 2.3 L	1990	T41081	TENSOR- POLEA DE DIST.
4 CIL. 2.3 L	1989	T41081	TENSOR- POLEA DE DIST.
4 CIL. 2.3 L	1988	T41081	TENSOR- POLEA DE DIST.
4 CIL. 2.3 L	1987	T41081	TENSOR- POLEA DE DIST.
4 CIL. 2.3 L	1986	T41081	TENSOR- POLEA DE DIST.
4 CIL. 2.3 L	1985	T41081	TENSOR- POLEA DE DIST.

### 760

4 CIL. 2.3 L	1990	T41081	TENSOR- POLEA DE DIST.
4 CIL. 2.3 L	1989	T41081	TENSOR- POLEA DE DIST.
4 CIL. 2.3 L	1988	T41081	TENSOR- POLEA DE DIST.
4 CIL. 2.3 L	1987	T41081	TENSOR- POLEA DE DIST.
4 CIL. 2.3 L	1986	T41081	TENSOR- POLEA DE DIST.
4 CIL. 2.3 L	1985	T41081	TENSOR- POLEA DE DIST.
4 CIL. 2.3 L	1984	T41081	TENSOR- POLEA DE DIST.

### 780

4 CIL. 2.3 L	1991	T41081	TENSOR- POLEA DE DIST.
4 CIL. 2.3 L	1990	T41081	TENSOR- POLEA DE DIST.
4 CIL. 2.3 L	1989	T41081	TENSOR- POLEA DE DIST.

### 850

5 CIL. 2.3 L	1997	38304	TENSOR PARA BANDA MICRO-V
5 CIL. 2.4 L	1997	38304	TENSOR PARA BANDA MICRO-V
5 CIL. 2.3 L	1996	38304	TENSOR PARA BANDA MICRO-V
5 CIL. 2.4 L	1996	38304	TENSOR PARA BANDA MICRO-V
5 CIL. 2.3 L	1995	38304	TENSOR PARA BANDA MICRO-V
5 CIL. 2.4 L	1995	38304	TENSOR PARA BANDA MICRO-V
5 CIL. 2.3 L	1994	38304	TENSOR PARA BANDA MICRO-V
5 CIL. 2.4 L	1994	38304	TENSOR PARA BANDA MICRO-V
5 CIL. 2.4 L	1993	38304	TENSOR PARA BANDA MICRO-V

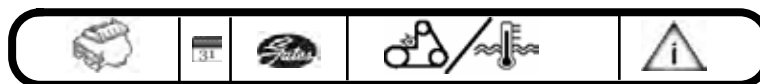

### 940

4 CIL. 2.3 L	1995	T41081	TENSOR- POLEA DE DIST.
4 CIL. 2.3 L	1994	T41081	TENSOR- POLEA DE DIST.
4 CIL. 2.3 L	1993	T41081	TENSOR- POLEA DE DIST.
4 CIL. 2.3 L	1992	T41081	TENSOR- POLEA DE DIST.
4 CIL. 2.3 L	1991	T41081	TENSOR- POLEA DE DIST.

### 960

6 CIL. 2.9 L	1994	38304	TENSOR PARA BANDA MICRO-V
6 CIL. 2.9 L	1993	38304	TENSOR PARA BANDA MICRO-V
6 CIL. 2.9 L	1992	38304	TENSOR PARA BANDA MICRO-V

### C30

5 CIL. 2.4 L	2010	TCK331	KIT DE DISTRIBUCION	
		T42097	TENSOR- POLEA DE DIST.	
		T43139	TENSOR- POLEA DE DIST.	
5 CIL. 2.5 L	2010	TCK331	KIT DE DISTRIBUCION	
		T43139	TENSOR- POLEA DE DIST.	
		T42097	TENSOR- POLEA DE DIST.	
5 CIL. 2.4 L	2009	TCK331	KIT DE DISTRIBUCION	
		T43139	TENSOR- POLEA DE DIST.	
		T42097	TENSOR- POLEA DE DIST.	
5 CIL. 2.5 L	2009	TCK331	KIT DE DISTRIBUCION	
		T42097	TENSOR- POLEA DE DIST.	
		T43139	TENSOR- POLEA DE DIST.	
5 CIL. 2.4 L	2008	TCK331	KIT DE DISTRIBUCION	
		T43139	TENSOR- POLEA DE DIST.	
		T42097	TENSOR- POLEA DE DIST.	
5 CIL. 2.4 L (Canada)	2008	T42097	TENSOR- POLEA DE DIST.	POLEA TENSORA
5 CIL. 2.5 L	2008	TCK331	KIT DE DISTRIBUCION	
		T43139	TENSOR- POLEA DE DIST.	
		T42097	TENSOR- POLEA DE DIST.	
5 CIL. 2.4 L (Canada)	2007	T42097	TENSOR- POLEA DE DIST.	POLEA TENSORA
5 CIL. 2.5 L (Canada)	2007	T42097	TENSOR- POLEA DE DIST.	POLEA TENSORA

### C70

5 CIL. 2.3 L	2004	TCKWP331	KIT DE DISTRIBUCION CON B.A.	
		38190	TENSOR	
		38018	TENSOR	
		38190	TENSOR PARA BANDA MICRO-V	
		T42097	TENSOR- POLEA DE DIST.	POLEA TENSORA
		T43139	TENSOR- POLEA DE DIST.	
5 CIL. 2.4 L	2004	TCKWP331	KIT DE DISTRIBUCION CON B.A.	
		38018	TENSOR	
		38190	TENSOR	
		T43139	TENSOR- POLEA DE DIST.	
		T42097	TENSOR- POLEA DE DIST.	POLEA TENSORA
5 CIL. 2.3 L	2003	TCKWP331	KIT DE DISTRIBUCION CON B.A.	
		38018	TENSOR	
		T43139	TENSOR- POLEA DE DIST.	
5 CIL. 2.4 L	2003	TCKWP331	KIT DE DISTRIBUCION CON B.A.	
		38018	TENSOR	
		T43139	TENSOR- POLEA DE DIST.	
		T42097	TENSOR- POLEA DE DIST.	POLEA TENSORA
5 CIL. 2.3 L	2002	TCKWP331	KIT DE DISTRIBUCION CON B.A.	
		38018	TENSOR	
		T42097	TENSOR- POLEA DE DIST.	POLEA TENSORA
5 CIL. 2.4 L	2002	TCKWP331	KIT DE DISTRIBUCION CON B.A.	
		38018	TENSOR	
		T42097	TENSOR- POLEA DE DIST.	POLEA TENSORA
5 CIL. 2.3 L	2001	TCKWP331	KIT DE DISTRIBUCION CON B.A.	
		38018	TENSOR	
		T43139	TENSOR- POLEA DE DIST.	
		T42097	TENSOR- POLEA DE DIST.	POLEA TENSORA
5 CIL. 2.4 L	2001	TCKWP331	KIT DE DISTRIBUCION CON B.A.	
		38018	TENSOR	
		T43139	TENSOR- POLEA DE DIST.	
5 CIL. 2.3 L	2000	TCKWP331	KIT DE DISTRIBUCION CON B.A.	

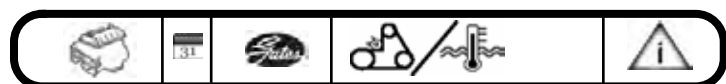

5 CIL. 2.3 L	2000	38018	TENSOR	POLEA TENSORA
		T42097	TENSOR- POLEA DE DIST.	
		T43139	TENSOR- POLEA DE DIST.	
5 CIL. 2.4 L	2000	TCKWP331	KIT DE DISTRIBUCION CON B.A.	
		38018	TENSOR	
		T43139	TENSOR- POLEA DE DIST.	
5 CIL. 2.3 L	1999	TCKWP331	KIT DE DISTRIBUCION CON B.A.	POLEA TENSORA
		T42097	TENSOR- POLEA DE DIST.	
		T43139	TENSOR- POLEA DE DIST.	
5 CIL. 2.4 L	1999	TCKWP331	KIT DE DISTRIBUCION CON B.A.	POLEA TENSORA
		T42097	TENSOR- POLEA DE DIST.	
		T43139	TENSOR- POLEA DE DIST.	
5 CIL. 2.3 L	1998	TCKWP331	KIT DE DISTRIBUCION CON B.A.	POLEA TENSORA
		38304	TENSOR PARA BANDA MICRO-V	
		T43139	TENSOR- POLEA DE DIST.	
		T42097	TENSOR- POLEA DE DIST.	
5 CIL. 2.4 L	1998	TCKWP331	KIT DE DISTRIBUCION CON B.A.	POLEA TENSORA
		38304	TENSOR PARA BANDA MICRO-V	

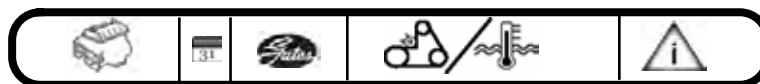





<b>S60</b>				
5 CIL. 2.4 L	2009	TCKWP331	KIT DE DISTRIBUCION CON B.A.	POLEA TENSORA
5 CIL. 2.5 L	2009	TCKWP331	KIT DE DISTRIBUCION CON B.A.	
5 CIL. 2.4 L	2008	TCKWP331	KIT DE DISTRIBUCION CON B.A.	
		T42097	TENSOR- POLEA DE DIST.	
		T43139	TENSOR- POLEA DE DIST.	
5 CIL. 2.5 L	2008	TCKWP331	KIT DE DISTRIBUCION CON B.A.	
5 CIL. 2.4 L	2007	TCKWP331	KIT DE DISTRIBUCION CON B.A.	
		T43139	TENSOR- POLEA DE DIST.	
		T42097	TENSOR- POLEA DE DIST.	
5 CIL. 2.5 L	2007	TCKWP331	KIT DE DISTRIBUCION CON B.A.	POLEA TENSORA
		T42097	TENSOR- POLEA DE DIST.	
		T43139	TENSOR- POLEA DE DIST.	
5 CIL. 2.4 L	2006	TCKWP331	KIT DE DISTRIBUCION CON B.A.	POLEA TENSORA
		38018	TENSOR	
		T43139	TENSOR- POLEA DE DIST.	
		T42097	TENSOR- POLEA DE DIST.	
5 CIL. 2.5 L	2006	TCKWP331	KIT DE DISTRIBUCION CON B.A.	POLEA TENSORA
		38190	TENSOR	
		38018	TENSOR	
		T42097	TENSOR- POLEA DE DIST.	
		T43139	TENSOR- POLEA DE DIST.	
5 CIL. 2.4 L	2005	TCKWP331	KIT DE DISTRIBUCION CON B.A.	POLEA TENSORA
		T42097	TENSOR- POLEA DE DIST.	
		T43139	TENSOR- POLEA DE DIST.	
5 CIL. 2.5 L	2005	TCKWP331	KIT DE DISTRIBUCION CON B.A.	POLEA TENSORA
		38018	TENSOR	
		38190	TENSOR	
		T42097	TENSOR- POLEA DE DIST.	
		T43139	TENSOR- POLEA DE DIST.	
5 CIL. 2.3 L	2004	T42097	TENSOR- POLEA DE DIST.	POLEA TENSORA
5 CIL. 2.4 L	2004	T43139	TENSOR- POLEA DE DIST.	
5 CIL. 2.5 L	2004	TCKWP331	KIT DE DISTRIBUCION CON B.A.	POLEA TENSORA
		T43139	TENSOR- POLEA DE DIST.	
		T42097	TENSOR- POLEA DE DIST.	
5 CIL. 2.5 L	2004	TCKWP331	KIT DE DISTRIBUCION CON B.A.	POLEA TENSORA
		38190	TENSOR	
		38018	TENSOR	
		T42097	TENSOR- POLEA DE DIST.	
5 CIL. 2.3 L	2003	T42097	TENSOR- POLEA DE DIST.	POLEA TENSORA
5 CIL. 2.4 L	2003	T43139	TENSOR- POLEA DE DIST.	
		TCKWP331	KIT DE DISTRIBUCION CON B.A.	
		38018	TENSOR	
		T42097	TENSOR- POLEA DE DIST.	
5 CIL. 2.5 L	2003	T43139	TENSOR- POLEA DE DIST.	POLEA TENSORA
		TCKWP331	KIT DE DISTRIBUCION CON B.A.	
		T43139	TENSOR- POLEA DE DIST.	
5 CIL. 2.3 L	2002	T42097	TENSOR- POLEA DE DIST.	POLEA TENSORA
5 CIL. 2.4 L	2002	T43139	TENSOR- POLEA DE DIST.	
		TCKWP331	KIT DE DISTRIBUCION CON B.A.	
		T43139	TENSOR- POLEA DE DIST.	
5 CIL. 2.3 L	2001	T42097	TENSOR- POLEA DE DIST.	POLEA TENSORA
		TCKWP331	KIT DE DISTRIBUCION CON B.A.	
		38018	TENSOR	
		T42097	TENSOR- POLEA DE DIST.	
5 CIL. 2.4 L	2001	T43139	TENSOR- POLEA DE DIST.	POLEA TENSORA
		TCKWP331	KIT DE DISTRIBUCION CON B.A.	
		38018	TENSOR	
		T43139	TENSOR- POLEA DE DIST.	
		T42097	TENSOR- POLEA DE DIST.	





**S40**

5 CIL. 2.4 L	2008	TCK331	KIT DE DISTRIBUCION	POLEA TENSORA
		T43139	TENSOR- POLEA DE DIST.	
		T42097	TENSOR- POLEA DE DIST.	
5 CIL. 2.5 L	2008	TCK331	KIT DE DISTRIBUCION	POLEA TENSORA
		T43139	TENSOR- POLEA DE DIST.	
		T42097	TENSOR- POLEA DE DIST.	
5 CIL. 2.4 L	2007	TCK331	KIT DE DISTRIBUCION	POLEA TENSORA
		T43139	TENSOR- POLEA DE DIST.	
		T42097	TENSOR- POLEA DE DIST.	
5 CIL. 2.5 L	2007	TCK331	KIT DE DISTRIBUCION	POLEA TENSORA
		T42097	TENSOR- POLEA DE DIST.	
		T43139	TENSOR- POLEA DE DIST.	
		T42097	TENSOR- POLEA DE DIST.	
5 CIL. 2.4 L	2006	TCK331	KIT DE DISTRIBUCION	POLEA TENSORA
		T42097	TENSOR- POLEA DE DIST.	
		T42097	TENSOR- POLEA DE DIST.	
		T43139	TENSOR- POLEA DE DIST.	
5 CIL. 2.5 L	2006	T42097	TENSOR- POLEA DE DIST.	POLEA TENSORA
5 CIL. 2.4 L	2005	TCK331	KIT DE DISTRIBUCION	POLEA TENSORA
		T42097	TENSOR- POLEA DE DIST.	
		T43139	TENSOR- POLEA DE DIST.	
		T42097	TENSOR- POLEA DE DIST.	
5 CIL. 2.5 L	2005	T42097	TENSOR- POLEA DE DIST.	POLEA TENSORA
4 CIL. 1.9 L	2004	38018	TENSOR	
		38190	TENSOR	
		T42097	TENSOR- POLEA DE DIST.	
		T43139	TENSOR- POLEA DE DIST.	
4 CIL. 1.9 L	2004	TCKWP331	KIT DE DISTRIBUCION CON B.A.	POLEA TENSORA
5 CIL. 2.4 L	2004	T42097	TENSOR- POLEA DE DIST.	POLEA TENSORA
5 CIL. 2.5 L	2004	T42097	TENSOR- POLEA DE DIST.	POLEA TENSORA
4 CIL. 1.9 L	2003	38018	TENSOR	
		38190	TENSOR	
		T43139	TENSOR- POLEA DE DIST.	
		T42097	TENSOR- POLEA DE DIST.	
4 CIL. 1.9 L	2003	TCKWP331	KIT DE DISTRIBUCION CON B.A.	POLEA TENSORA
4 CIL. 1.9 L	2002	38018	TENSOR	
		38190	TENSOR	
		T43139	TENSOR- POLEA DE DIST.	
		T42097	TENSOR- POLEA DE DIST.	
4 CIL. 1.9 L	2002	TCKWP331	KIT DE DISTRIBUCION CON B.A.	POLEA TENSORA
4 CIL. 1.9 L	2001	38018	TENSOR	
		T43139	TENSOR- POLEA DE DIST.	
		T42097	TENSOR- POLEA DE DIST.	
4 CIL. 1.9 L	2001	TCKWP331	KIT DE DISTRIBUCION CON B.A.	POLEA TENSORA
4 CIL. 1.9 L	2000	38018	TENSOR	
		T42097	TENSOR- POLEA DE DIST.	
		T43139	TENSOR- POLEA DE DIST.	
4 CIL. 1.9 L	2000	TCKWP331	KIT DE DISTRIBUCION CON B.A.	POLEA TENSORA

**S70**

5 CIL. 2.3 L	2000	TCKWP331	KIT DE DISTRIBUCION CON B.A.	POLEA TENSORA
		38018	TENSOR	
		T42097	TENSOR- POLEA DE DIST.	
		T43139	TENSOR- POLEA DE DIST.	
5 CIL. 2.4 L	2000	TCKWP331	KIT DE DISTRIBUCION CON B.A.	POLEA TENSORA
		38018	TENSOR	
		T43139	TENSOR- POLEA DE DIST.	

				
5 CIL. 2.4 L	2000	T42097	TENSOR- POLEA DE DIST.	POLEA TENSORA
5 CIL. 2.3 L	1999	TCKWP331	KIT DE DISTRIBUCION CON B.A.	
		T42097	TENSOR- POLEA DE DIST.	POLEA TENSORA
		T43139	TENSOR- POLEA DE DIST.	
5 CIL. 2.4 L	1999	TCKWP331	KIT DE DISTRIBUCION CON B.A.	
		T42097	TENSOR- POLEA DE DIST.	POLEA TENSORA
		T43139	TENSOR- POLEA DE DIST.	
5 CIL. 2.3 L	1998	TCKWP331	KIT DE DISTRIBUCION CON B.A.	
		38304	TENSOR PARA BANDA MICRO-V	
		T43139	TENSOR- POLEA DE DIST.	
		T42097	TENSOR- POLEA DE DIST.	POLEA TENSORA
5 CIL. 2.4 L	1998	TCKWP331	KIT DE DISTRIBUCION CON B.A.	
		38304	TENSOR PARA BANDA MICRO-V	
		T43139	TENSOR- POLEA DE DIST.	
		T42097	TENSOR- POLEA DE DIST.	POLEA TENSORA

				
5 CIL. 2.5 L	2007	T43139	TENSOR- POLEA DE DIST.	POLEA TENSORA
		T42097	TENSOR- POLEA DE DIST.	
		T43139	TENSOR- POLEA DE DIST.	
5 CIL. 2.4 L	2006	T43139	TENSOR- POLEA DE DIST.	
		T42097	TENSOR- POLEA DE DIST.	POLEA TENSORA
5 CIL. 2.5 L	2006	T42097	TENSOR- POLEA DE DIST.	POLEA TENSORA
		T43139	TENSOR- POLEA DE DIST.	
5 CIL. 2.4 L	2005	T43139	TENSOR- POLEA DE DIST.	
		T42097	TENSOR- POLEA DE DIST.	POLEA TENSORA
5 CIL. 2.5 L	2005	T43139	TENSOR- POLEA DE DIST.	
		T42097	TENSOR- POLEA DE DIST.	POLEA TENSORA
5 CIL. 2.3 L	2004	TCKWP331	KIT DE DISTRIBUCION CON B.A.	
		T43139	TENSOR- POLEA DE DIST.	
		T42097	TENSOR- POLEA DE DIST.	POLEA TENSORA
5 CIL. 2.4 L	2004	T43139	TENSOR- POLEA DE DIST.	
		T42097	TENSOR- POLEA DE DIST.	POLEA TENSORA
5 CIL. 2.5 L	2004	T42097	TENSOR- POLEA DE DIST.	POLEA TENSORA
		T43139	TENSOR- POLEA DE DIST.	
5 CIL. 2.3 L	2003	TCKWP331	KIT DE DISTRIBUCION CON B.A.	
		T43139	TENSOR- POLEA DE DIST.	
		T42097	TENSOR- POLEA DE DIST.	POLEA TENSORA
5 CIL. 2.4 L	2003	T42097	TENSOR- POLEA DE DIST.	POLEA TENSORA
		T43139	TENSOR- POLEA DE DIST.	
5 CIL. 2.5 L	2003	T43139	TENSOR- POLEA DE DIST.	
		T42097	TENSOR- POLEA DE DIST.	POLEA TENSORA
5 CIL. 2.3 L	2002	TCKWP331	KIT DE DISTRIBUCION CON B.A.	
		T42097	TENSOR- POLEA DE DIST.	POLEA TENSORA
		T43139	TENSOR- POLEA DE DIST.	
5 CIL. 2.4 L	2002	T42097	TENSOR- POLEA DE DIST.	POLEA TENSORA
		T43139	TENSOR- POLEA DE DIST.	
5 CIL. 2.3 L	2001	TCKWP331	KIT DE DISTRIBUCION CON B.A.	
		T42097	TENSOR- POLEA DE DIST.	POLEA TENSORA
		T43139	TENSOR- POLEA DE DIST.	
5 CIL. 2.4 L	2001	T42097	TENSOR- POLEA DE DIST.	POLEA TENSORA
		T43139	TENSOR- POLEA DE DIST.	
5 CIL. 2.3 L	2000	TCKWP331	KIT DE DISTRIBUCION CON B.A.	
		T42097	TENSOR- POLEA DE DIST.	POLEA TENSORA
		T43139	TENSOR- POLEA DE DIST.	
5 CIL. 2.4 L	2000	T42097	TENSOR- POLEA DE DIST.	POLEA TENSORA
		T43139	TENSOR- POLEA DE DIST.	
5 CIL. 2.3 L	1999	TCKWP331	KIT DE DISTRIBUCION CON B.A.	
		T43139	TENSOR- POLEA DE DIST.	
		T42097	TENSOR- POLEA DE DIST.	POLEA TENSORA
5 CIL. 2.4 L	1999	T43139	TENSOR- POLEA DE DIST.	POLEA TENSORA
		T42097	TENSOR- POLEA DE DIST.	
5 CIL. 2.3 L	1998	TCKWP331	KIT DE DISTRIBUCION CON B.A.	
		38304	TENSOR PARA BANDA MICRO-V	
		T43139	TENSOR- POLEA DE DIST.	
		T42097	TENSOR- POLEA DE DIST.	POLEA TENSORA
5 CIL. 2.4 L	1998	38304	TENSOR PARA BANDA MICRO-V	
		T43139	TENSOR- POLEA DE DIST.	
		T42097	TENSOR- POLEA DE DIST.	POLEA TENSORA

**S80**

5 CIL. 2.5 L	2006	38018	TENSOR	
		38190	TENSOR	
		T42097	TENSOR- POLEA DE DIST.	POLEA TENSORA
		T43139	TENSOR- POLEA DE DIST.	
5 CIL. 2.5 L	2005	38190	TENSOR	
		38018	TENSOR	
		T42097	TENSOR- POLEA DE DIST.	POLEA TENSORA
		T43139	TENSOR- POLEA DE DIST.	
6 CIL. 2.9 L	2005	38018	TENSOR	
		38190	TENSOR	
5 CIL. 2.5 L	2004	T43139	TENSOR- POLEA DE DIST.	
		T42097	TENSOR- POLEA DE DIST.	POLEA TENSORA
6 CIL. 2.9 L	2004	38018	TENSOR	
		38190	TENSOR	
6 CIL. 2.9 L	2003	38190	TENSOR	
		38018	TENSOR	
6 CIL. 2.9 L	2002	38190	TENSOR	
		38018	TENSOR	
6 CIL. 2.8 L	2001	38018	TENSOR	
6 CIL. 2.9 L	2001	38018	TENSOR	
6 CIL. 2.8 L	2000	38018	TENSOR	
6 CIL. 2.9 L	2000	38018	TENSOR	

**V40**

4 CIL. 1.9 L	2004	T42097	TENSOR- POLEA DE DIST.	POLEA TENSORA
		T43139	TENSOR- POLEA DE DIST.	
4 CIL. 1.9 L	2004	TCKWP331	KIT DE DISTRIBUCION CON B.A.	
5 CIL. 2.3 L	2004	TCKWP331	KIT DE DISTRIBUCION CON B.A.	
4 CIL. 1.9 L	2003	T43139	TENSOR- POLEA DE DIST.	
		T42097	TENSOR- POLEA DE DIST.	POLEA TENSORA
4 CIL. 1.9 L	2003	TCKWP331	KIT DE DISTRIBUCION CON B.A.	
5 CIL. 2.3 L	2003	TCKWP331	KIT DE DISTRIBUCION CON B.A.	
4 CIL. 1.9 L	2002	T43139	TENSOR- POLEA DE DIST.	
		T42097	TENSOR- POLEA DE DIST.	POLEA TENSORA
4 CIL. 1.9 L	2002	TCKWP331	KIT DE DISTRIBUCION CON B.A.	
5 CIL. 2.3 L	2002	TCKWP331	KIT DE DISTRIBUCION CON B.A.	
4 CIL. 1.9 L	2001	T42097	TENSOR- POLEA DE DIST.	POLEA TENSORA
		T43139	TENSOR- POLEA DE DIST.	
4 CIL. 1.9 L	2001	TCKWP331	KIT DE DISTRIBUCION CON B.A.	
4 CIL. 1.9 L	2000	T42097	TENSOR- POLEA DE DIST.	POLEA TENSORA
		T43139	TENSOR- POLEA DE DIST.	
4 CIL. 1.9 L	2000	TCKWP331	KIT DE DISTRIBUCION CON B.A.	

**V50**

5 CIL. 2.4 L	2007	T42097	TENSOR- POLEA DE DIST.	POLEA TENSORA
5 CIL. 2.5 L	2007	T42097	TENSOR- POLEA DE DIST.	POLEA TENSORA
5 CIL. 2.4 L	2006	T42097	TENSOR- POLEA DE DIST.	POLEA TENSORA
5 CIL. 2.5 L	2006	T42097	TENSOR- POLEA DE DIST.	POLEA TENSORA
5 CIL. 2.4 L	2005	T42097	TENSOR- POLEA DE DIST.	POLEA TENSORA
5 CIL. 2.5 L	2005	T42097	TENSOR- POLEA DE DIST.	POLEA TENSORA

**V70**

5 CIL. 2.4 L	2007	T42097	TENSOR- POLEA DE DIST.	POLEA TENSORA
--------------	------	--------	------------------------	---------------

**XC70**

5 CIL. 2.5 L	2004	T43139	TENSOR- POLEA DE DIST.	
		T42097	TENSOR- POLEA DE DIST.	POLEA TENSORA

**XC90**

5 CIL. 2.5 L	2006	TCK331	KIT DE DISTRIBUCION	
		TCKWP331	KIT DE DISTRIBUCION CON B.A.	
		38190	TENSOR	
		T42097	TENSOR- POLEA DE DIST.	
		T42097	TENSOR- POLEA DE DIST.	POLEA TENSORA
		T43139	TENSOR- POLEA DE DIST.	
		T43139	TENSOR- POLEA DE DIST.	
5 CIL. 2.5 L	2005	TCK331	KIT DE DISTRIBUCION	
		TCKWP331	KIT DE DISTRIBUCION CON B.A.	
		38190	TENSOR	
		T43139	TENSOR- POLEA DE DIST.	
		T42097	TENSOR- POLEA DE DIST.	POLEA TENSORA
		T42097	TENSOR- POLEA DE DIST.	



5 CIL. 2.5 L	2005	T43139	TENSOR- POLEA DE DIST.	
5 CIL. 2.5 L	2004	TCK331	KIT DE DISTRIBUCION	
		TCKWP331	KIT DE DISTRIBUCION CON B.A.	
		38190	TENSOR	
		T43139	TENSOR- POLEA DE DIST.	POLEA TENSORA
		T42097	TENSOR- POLEA DE DIST.	
		T42097	TENSOR- POLEA DE DIST.	
		T43139	TENSOR- POLEA DE DIST.	
5 CIL. 2.5 L	2003	TCK331	KIT DE DISTRIBUCION	
		TCKWP331	KIT DE DISTRIBUCION CON B.A.	
		38190	TENSOR	
		T43139	TENSOR- POLEA DE DIST.	POLEA TENSORA
		T42097	TENSOR- POLEA DE DIST.	
		T42097	TENSOR- POLEA DE DIST.	
		T43139	TENSOR- POLEA DE DIST.	



# BLUEBIRD

## ALL AMERICAN FE

Caterpillar C7 Diesel	2006	38509	TENSOR	- Alt.
Caterpillar C7 Diesel	2005	38509	TENSOR	- Alt.

## ALL AMERICAN RE

Caterpillar C7 Diesel	2006	36091	POLEA	Tensora
		38509	TENSOR	- Toma Fuerza & Alt.
John Deere 6-Cyl. 8.1 L Diesel	2006	38507	TENSOR	- Alt.
Caterpillar C7 Diesel	2005	36091	POLEA	Tensora
		38509	TENSOR	- Toma Fuerza & Alt.
Caterpillar 3126 Diesel	2004	36091	POLEA	Tensora
		38509	TENSOR	- Toma Fuerza & Alt.
Cummins ISC Diesel	2004	38525	TENSOR	
Caterpillar 3126 Diesel	2003	36091	POLEA	Tensora
		38509	TENSOR	- Toma Fuerza & Alt.
Cummins ISC Diesel	2003	36093	POLEA	Tensora
		38516	TENSOR	
John Deere 6-Cyl. 8.1 L CNG	2003	36091	POLEA	Tensora - Mot. a Alt.
		38507	TENSOR	- Mot. a Alt.
Cummins ISC Diesel	2002	36093	POLEA	Tensora
		38516	TENSOR	
John Deere 6-Cyl. 8.1 L CNG	2002	36091	POLEA	Tensora
		38507	TENSOR	
Cummins ISC Diesel	2001	36093	POLEA	Tensora
		38516	TENSOR	
John Deere 6-Cyl. 8.1 L CNG	2001	36091	POLEA	Tensora
		38507	TENSOR	
Cummins ISC Diesel	2000	36091	POLEA	Tensora
		38513	TENSOR	
John Deere 6-Cyl. 8.1 L CNG	2000	36091	POLEA	Tensora
		38507	TENSOR	
Cummins ISB Diesel	1999	36093	POLEA	Tensora - Alt. & B.A.
		38516	TENSOR	- Alt. & B.A.
Cummins ISC Diesel	1999	36091	POLEA	Tensora
		38513	TENSOR	
Cummins ISC Diesel	1998	36091	POLEA	Tensora - Alt. & B.A.
		38513	TENSOR	- Alt. & B.A.
John Deere 6-Cyl. 8.1 L CNG	1998	38507	TENSOR	

## CONVENTIONAL

International/Navistar DT466 Diesel	2004	36091	POLEA	Tensora
		38514	TENSOR	
International/Navistar DT466 Diesel	2003	36091	POLEA	Tensora
		38514	TENSOR	
International/Navistar DT466 Diesel	2002	36091	POLEA	Tensora
		38514	TENSOR	
Cummins ISB Diesel	2001	36093	POLEA	Tensora - Alt. & B.A.
		38516	TENSOR	- Alt. & B.A.
International/Navistar DT466 Diesel	2001	36091	POLEA	Tensora
		38514	TENSOR	
International/Navistar DT466 Diesel	2000	36091	POLEA	Tensora
		38514	TENSOR	
International/Navistar DT466 Diesel	1999	36091	POLEA	Tensora
		38514	TENSOR	

## MINI BIRD

GM V-8 5.7 L	1998	38103	TENSOR	
		38001	POLEA	guía - Lisa
		38008	POLEA	Tensora
		38008	POLEA	guía - ranurada

## TC2000

Cummins ISB Diesel	2000	36093	POLEA	Tensora - Alt. & B.A.
		38516	TENSOR	- Alt. & B.A.
Cummins ISB Diesel	1999	36093	POLEA	Tensora - Alt. & B.A.

## VISION

Caterpillar C7 Diesel	2007	38550	TENSOR	- Alt.
Caterpillar C7 Diesel	2006	38550	TENSOR	- Alt.
Cummins ISB Diesel	2006	38525	TENSOR	- Ventilador & Alt.

# CHEVROLET

## C4500

GM V-8 6.6 L Diesel	2008	38172	TENSOR	
		38008	POLEA	Tensora
GM V-8 8.1 L	2008	38006	POLEA	Tensora
		38258	TENSOR	- Ventilador, Alt., E.D.H. & A.A.
		38001	POLEA	guía
GM V-8 6.6 L Diesel	2007	38172	TENSOR	
		38008	POLEA	Tensora
GM V-8 8.1 L	2007	38006	POLEA	Tensora
		38001	POLEA	guía - Lisa
		38008	POLEA	guía - ranurada
GM V-8 6.6 L Diesel	2006	38172	TENSOR	
		38008	POLEA	Tensora
GM V-8 8.1 L	2006	38001	POLEA	guía - Lisa
		38008	POLEA	guía - ranurada
		38006	POLEA	Tensora
		38001	POLEA	guía
		38258	TENSOR	
GM V-8 6.6 L Diesel	2005	38172	TENSOR	
		38008	POLEA	Tensora
GM V-8 8.1 L	2005	38006	POLEA	Tensora
		38008	POLEA	guía - ranurada
		38258	TENSOR	
		38001	POLEA	guía
		38001	POLEA	guía - Lisa
GM V-8 6.6 L Diesel	2004	38172	TENSOR	
		38008	POLEA	Tensora
GM V-8 8.1 L	2004	38006	POLEA	Tensora
		38258	TENSOR	
		38008	POLEA	guía - ranurada
		38001	POLEA	guía - Lisa
		38001	POLEA	guía
GM V-8 6.6 L Diesel	2003	38172	TENSOR	
		38008	POLEA	Tensora
GM V-8 8.1 L	2003	38001	POLEA	guía
		38001	POLEA	guía - Lisa
		38258	TENSOR	
		38006	POLEA	Tensora
		38008	POLEA	guía - ranurada

## C5500

GM V-8 6.6 L Diesel	2008	38172	TENSOR	
		38008	POLEA	Tensora
GM V-8 8.1 L	2008	38006	POLEA	Tensora
		38001	POLEA	guía
		38258	TENSOR	- Ventilador, Alt., E.D.H. & A.A.
GM V-8 6.6 L Diesel	2007	38172	TENSOR	
		38008	POLEA	Tensora
GM V-8 8.1 L	2007	38001	POLEA	guía - Lisa
		38258	TENSOR	
		38006	POLEA	Tensora
		38008	POLEA	guía - ranurada
GM V-8 6.6 L Diesel	2006	38172	TENSOR	
		38008	POLEA	Tensora
GM V-8 8.1 L	2006	38006	POLEA	Tensora
		38258	TENSOR	

GM V-8 8.1 L	2006	38001	POLEA	guía
		38008	POLEA	guía - ranurada
		38001	POLEA	guía - Lisa
GM V-8 6.6 L Diesel	2005	38172	SENSOR	
		38008	POLEA	Tensora
GM V-8 8.1 L	2005	38258	SENSOR	
		38006	POLEA	Tensora
		38001	POLEA	guía - Lisa
		38001	POLEA	guía
		38008	POLEA	guía - ranurada
GM V-8 6.6 L Diesel	2004	38172	SENSOR	
		38008	POLEA	Tensora
GM V-8 8.1 L	2004	38001	POLEA	guía - Lisa
		38006	POLEA	Tensora
		38008	POLEA	guía - ranurada
		38258	SENSOR	
		38001	POLEA	guía
GM V-8 6.6 L Diesel	2003	38172	SENSOR	
		38008	POLEA	Tensora
GM V-8 8.1 L	2003	38001	POLEA	guía
		38008	POLEA	guía - ranurada
		38006	POLEA	Tensora
		38258	SENSOR	
		38001	POLEA	guía - Lisa
Caterpillar 3126 Diesel	2002	36096	POLEA	guía
		36091	POLEA	guía
		38509	SENSOR	Tensora
GM V-8 8.1 L	2002	38256	SENSOR	- Ventilador, Alt., E.D.H. & A.A.
		38033	POLEA	Tensora - Ventilador, Alt., E.D.H. & A.A.
		38006	POLEA	Tensora - Ventilador & Compr. de Aire
		38261	SENSOR	- Ventilador & Compr. de Aire
Caterpillar 3126 Diesel	2001	36096	POLEA	guía
		36091	POLEA	Tensora
		38509	SENSOR	
GM V-8 8.1 L	2001	38256	SENSOR	- Ventilador, Alt., E.D.H. & A.A.
		38006	POLEA	Tensora - Ventilador & Compr. de Aire
		38033	POLEA	Tensora - Ventilador, Alt., E.D.H. & A.A.
		38261	SENSOR	- Ventilador & Compr. de Aire
Caterpillar 3126 Diesel	2000	36091	POLEA	Tensora
		36096	POLEA	guía
		38509	SENSOR	
Caterpillar 3116 Diesel	1999	36091	POLEA	Tensora
		38509	SENSOR	
Caterpillar 3126 Diesel	1999	36091	POLEA	Tensora
		36096	POLEA	guía
		38509	SENSOR	
Caterpillar 3126 Diesel	1998	36096	POLEA	guía
		36091	POLEA	Tensora
		38509	SENSOR	

Caterpillar C7 Diesel	2004	38586	SENSOR	- Ventilador, Alt. & A.A.
		36096	POLEA	guía
GM V-8 8.1 L	2004	38006	POLEA	Tensora - Ventilador & Compr. de Aire
		38324	SENSOR	- Compr. Frenos Aire
		38256	SENSOR	- Ventilador, Alt., E.D.H. & A.A.
		38033	POLEA	Tensora - Ventilador, Alt., E.D.H. & A.A.
Isuzu 6HK1-TC Diesel	2004	38548	SENSOR	
Caterpillar 3126 Diesel	2003	38557	SENSOR	
		36096	POLEA	guía
		36091	POLEA	Tensora
GM V-8 8.1 L	2003	38006	POLEA	Tensora - Ventilador & Compr. de Aire
		38324	SENSOR	- Compr. Frenos Aire
		38033	POLEA	Tensora - Ventilador, Alt., E.D.H. & A.A.
		38256	SENSOR	- Ventilador, Alt., E.D.H. & A.A.
Isuzu 6HK1-TC Diesel	2003	38548	SENSOR	
Caterpillar 3126 Diesel	2002	36091	POLEA	Tensora
		36096	POLEA	guía
		38509	SENSOR	
GM V-8 8.1 L	2002	38256	SENSOR	- Ventilador, Alt., E.D.H. & A.A.
		38261	SENSOR	- Ventilador & Compr. de Aire
		38006	POLEA	Tensora - Ventilador & Compr. de Aire
		38033	POLEA	Tensora - Ventilador, Alt., E.D.H. & A.A.
Caterpillar 3126 Diesel	2001	36096	POLEA	guía
		36091	POLEA	Tensora
		38509	SENSOR	
GM V-8 8.1 L	2001	38256	SENSOR	- Ventilador, Alt., E.D.H. & A.A.
		38261	SENSOR	- Ventilador & Compr. de Aire
		38006	POLEA	Tensora - Ventilador & Compr. de Aire
		38033	POLEA	Tensora - Ventilador, Alt., E.D.H. & A.A.
Caterpillar 3116 Diesel	2000	36091	POLEA	Tensora
Caterpillar 3126 Diesel	2000	36091	POLEA	Tensora
		36096	POLEA	guía
		38509	SENSOR	
Caterpillar 3116 Diesel	1999	36091	POLEA	Tensora
		38509	SENSOR	
Caterpillar 3126 Diesel	1999	36091	POLEA	Tensora
		36096	POLEA	guía
		38509	SENSOR	
Caterpillar 3126 Diesel	1998	36096	POLEA	guía
		36091	POLEA	Tensora
		38509	SENSOR	

**C6500**

GM V-8 8.1 L	2008	38324	SENSOR	- Compr. Frenos Aire
		38256	SENSOR	- Ventilador, Alt., E.D.H. & A.A.
		38033	POLEA	Tensora - Ventilador, Alt., E.D.H. & A.A.
		38006	POLEA	Tensora - Ventilador & Compr. de Aire
Caterpillar C7 Diesel	2007	38586	SENSOR	- Ventilador, Alt. & A.A.
		36096	POLEA	guía
GM V-8 8.1 L	2007	38256	SENSOR	- Ventilador, Alt., E.D.H. & A.A.
		38324	SENSOR	- Compr. Frenos Aire
		38033	POLEA	Tensora - Ventilador, Alt., E.D.H. & A.A.
		38006	POLEA	Tensora - Ventilador & Compr. de Aire
Caterpillar C7 Diesel	2006	38586	SENSOR	- Ventilador, Alt. & A.A.
		36096	POLEA	guía
GM V-8 8.1 L	2006	38033	POLEA	Tensora - Ventilador, Alt., E.D.H. & A.A.
		38256	SENSOR	- Ventilador, Alt., E.D.H. & A.A.
		38006	POLEA	Tensora - Ventilador & Compr. de Aire
Isuzu 6HK1-TC Diesel	2006	38548	SENSOR	
Caterpillar C7 Diesel	2005	38586	SENSOR	- Ventilador, Alt. & A.A.
		36096	POLEA	guía
GM V-8 8.1 L	2005	38033	POLEA	Tensora - Ventilador, Alt., E.D.H. & A.A.
		38256	SENSOR	- Ventilador, Alt., E.D.H. & A.A.
		38006	POLEA	Tensora - Ventilador & Compr. de Aire
Isuzu 6HK1-TC Diesel	2005	38548	SENSOR	

**C7500**

GM V-8 8.1 L	2008	38033	POLEA	Tensora - Ventilador, Alt., E.D.H. & A.A.
		38006	POLEA	Tensora - Ventilador & Compr. de Aire
		38256	SENSOR	- Ventilador, Alt., E.D.H. & A.A.
Caterpillar C7 Diesel	2007	38586	SENSOR	- Ventilador, Alt. & A.A.
		36096	POLEA	guía
GM V-8 8.1 L	2007	38033	POLEA	Tensora - Ventilador, Alt., E.D.H. & A.A.
		38324	SENSOR	- Compr. Frenos Aire
		38256	SENSOR	- Ventilador, Alt., E.D.H. & A.A.
		38006	POLEA	Tensora - Ventilador & Compr. de Aire
Caterpillar C7 Diesel	2006	38586	SENSOR	- Ventilador, Alt. & A.A.
		36096	POLEA	guía
GM V-8 8.1 L	2006	38256	SENSOR	- Ventilador, Alt., E.D.H. & A.A.
		38006	POLEA	Tensora - Ventilador & Compr. de Aire
		38033	POLEA	Tensora - Ventilador, Alt., E.D.H. & A.A.
		38324	SENSOR	- Compr. Frenos Aire
Isuzu 6HK1-TC Diesel	2006	38548	SENSOR	
Caterpillar C7 Diesel	2005	38586	SENSOR	- Ventilador, Alt. & A.A.
		36096	POLEA	guía
GM V-8 8.1 L	2005	38006	POLEA	Tensora - Ventilador & Compr. de Aire
		38324	SENSOR	- Compr. Frenos Aire
		38256	SENSOR	- Ventilador, Alt., E.D.H. & A.A.
		38033	POLEA	Tensora - Ventilador, Alt., E.D.H. & A.A.
Isuzu 6HK1-TC Diesel	2005	38548	SENSOR	
Caterpillar C7 Diesel	2004	38586	SENSOR	- Ventilador, Alt. & A.A.
		36096	POLEA	guía
GM V-8 8.1 L	2004	38033	POLEA	Tensora - Ventilador, Alt., E.D.H. & A.A.



GM V-8 8.1 L	2004	38324	SENSOR	- Compr. Frenos Aire
		38256	SENSOR	- Ventilador, Alt., E.D.H. & A.A.
		38006	POLEA	Tensora - Ventilador & Compr. de Aire
Isuzu 6HK1-TC Diesel	2004	38548	SENSOR	
Caterpillar 3126 Diesel	2003	38557	SENSOR	
		36091	POLEA	Tensora
		36096	POLEA	guía
GM V-8 8.1 L	2003	38033	POLEA	Tensora - Ventilador, Alt., E.D.H. & A.A.
		38324	SENSOR	- Compr. Frenos Aire
		38256	SENSOR	- Ventilador, Alt., E.D.H. & A.A.
		38006	POLEA	Tensora - Ventilador & Compr. de Aire
Isuzu 6HK1-TC Diesel	2003	38548	SENSOR	
Caterpillar 3126 Diesel	2002	36091	POLEA	Tensora
		36096	POLEA	guía
GM V-8 8.1 L	2002	38033	POLEA	Tensora - Ventilador, Alt., E.D.H. & A.A.
		38256	SENSOR	- Ventilador, Alt., E.D.H. & A.A.
		38261	SENSOR	- Ventilador & Compr. de Aire
		38006	POLEA	Tensora - Ventilador & Compr. de Aire
Caterpillar 3126 Diesel	2001	36096	POLEA	guía
		36091	POLEA	Tensora
		38509	SENSOR	
GM V-8 8.1 L	2001	38006	POLEA	Tensora - Ventilador & Compr. de Aire
		38033	POLEA	Tensora - Ventilador, Alt., E.D.H. & A.A.
		38256	SENSOR	- Ventilador, Alt., E.D.H. & A.A.
Caterpillar 3116 Diesel	2000	38261	SENSOR	- Ventilador & Compr. de Aire
Caterpillar 3126 Diesel	2000	36091	POLEA	Tensora
		38509	SENSOR	
Caterpillar 3116 Diesel	1999	36091	POLEA	Tensora
Caterpillar 3126 Diesel	1999	36096	POLEA	guía
		36091	POLEA	Tensora
Caterpillar 3116 Diesel	1998	38509	SENSOR	
Caterpillar 3126 Diesel	1998	36096	POLEA	guía
		36091	POLEA	Tensora
Caterpillar 3116 Diesel	1998	38509	SENSOR	
Caterpillar 3126 Diesel	1998	36096	POLEA	guía
		36091	POLEA	Tensora
Caterpillar 3116 Diesel	1997	38509	SENSOR	
		36091	POLEA	Tensora
		38509	SENSOR	Tensora

Isuzu 6HK1-TC Diesel		38548	SENSOR	
Caterpillar 3126 Diesel	2003	38557	SENSOR	
		36091	POLEA	Tensora
		36096	POLEA	guía
GM V-8 8.1 L	2003	38256	SENSOR	- Ventilador, Alt., E.D.H. & A.A.
		38033	POLEA	Tensora - Ventilador, Alt., E.D.H. & A.A.
		38324	SENSOR	- Compr. Frenos Aire
		38006	POLEA	Tensora - Ventilador & Compr. de Aire
Isuzu 6HK1-TC Diesel	2003	38548	SENSOR	
Caterpillar 3126 Diesel	2002	36091	POLEA	Tensora
		36096	POLEA	guía
GM V-8 8.1 L	2002	38256	SENSOR	- Ventilador, Alt., E.D.H. & A.A.
		38006	POLEA	Tensora - Ventilador & Compr. de Aire
		38261	SENSOR	- Ventilador & Compr. de Aire
		38033	POLEA	Tensora - Ventilador, Alt., E.D.H. & A.A.
Caterpillar 3126 Diesel	2001	36091	POLEA	Tensora
		36096	POLEA	guía
		38509	SENSOR	
GM V-8 8.1 L	2001	38256	SENSOR	- Ventilador, Alt., E.D.H. & A.A.
		38006	POLEA	Tensora - Ventilador & Compr. de Aire
		38033	POLEA	Tensora - Ventilador, Alt., E.D.H. & A.A.
		38261	SENSOR	- Ventilador & Compr. de Aire
Caterpillar 3116 Diesel	2000	36091	POLEA	Tensora
Caterpillar 3126 Diesel	2000	36096	POLEA	guía
		36091	POLEA	Tensora
		38509	SENSOR	
Caterpillar 3116 Diesel	1999	36091	POLEA	Tensora
Caterpillar 3126 Diesel	1999	38509	SENSOR	
		36091	POLEA	Tensora
Caterpillar 3116 Diesel	1998	36091	POLEA	Tensora
Caterpillar 3126 Diesel	1998	38509	SENSOR	
		36091	POLEA	Tensora
Caterpillar 3116 Diesel	1997	38509	SENSOR	
		36091	POLEA	Tensora
		38509	SENSOR	Tensora

**C8500**

GM V-8 8.1 L	2008	38033	POLEA	Tensora - Ventilador, Alt., E.D.H. & A.A.
		38256	SENSOR	- Ventilador, Alt., E.D.H. & A.A.
		38006	POLEA	Tensora - Ventilador & Compr. de Aire
Caterpillar C7 Diesel	2007	38324	SENSOR	- Compr. Frenos Aire
		38586	SENSOR	- Ventilador, Alt. & A.A.
		36096	POLEA	guía
GM V-8 8.1 L	2007	38256	SENSOR	- Ventilador, Alt., E.D.H. & A.A.
		38324	SENSOR	- Compr. Frenos Aire
		38006	POLEA	Tensora - Ventilador & Compr. de Aire
Caterpillar C7 Diesel	2006	38033	POLEA	Tensora - Ventilador, Alt., E.D.H. & A.A.
		38586	SENSOR	- Ventilador, Alt. & A.A.
		36096	POLEA	guía
GM V-8 8.1 L	2006	38006	POLEA	Tensora - Ventilador & Compr. de Aire
		38256	SENSOR	- Ventilador, Alt., E.D.H. & A.A.
		38324	SENSOR	- Compr. Frenos Aire
Caterpillar C7 Diesel	2006	38033	POLEA	Tensora - Ventilador, Alt., E.D.H. & A.A.
Isuzu 6HK1-TC Diesel	2006	38548	SENSOR	
Caterpillar C7 Diesel	2005	38586	SENSOR	- Ventilador, Alt. & A.A.
		36096	POLEA	guía
GM V-8 8.1 L	2005	38324	SENSOR	- Compr. Frenos Aire
		38256	SENSOR	- Ventilador, Alt., E.D.H. & A.A.
		38006	POLEA	Tensora - Ventilador & Compr. de Aire
		38033	POLEA	Tensora - Ventilador, Alt., E.D.H. & A.A.
Isuzu 6HK1-TC Diesel	2005	38548	SENSOR	
Caterpillar C7 Diesel	2004	38586	SENSOR	- Ventilador, Alt. & A.A.
		36096	POLEA	guía
GM V-8 8.1 L	2004	38033	POLEA	Tensora - Ventilador, Alt., E.D.H. & A.A.
		38006	POLEA	Tensora - Ventilador & Compr. de Aire
		38256	SENSOR	- Ventilador, Alt., E.D.H. & A.A.
		38324	SENSOR	- Compr. Frenos Aire

**KODIAK**

CATERPILLAR 3126 DIESEL	2008	36091	POLEA DEL TEN	
		36096	POLEA LOCA	
		38509	SENSOR	
GM V-8, 8.1 L	2008	38256	SENSOR	MOTOR
		38261	SENSOR	COMPRESOR AIRE
CATERPILLAR 3126 DIESEL	2007	36096	POLEA LOCA	
		36091	POLEA DEL TEN	
		38509	SENSOR	
GM V-8, 8.1 L	2007	38256	SENSOR	MOTOR
		38261	SENSOR	COMPRESOR AIRE
CATERPILLAR 3126 DIESEL	2006	36096	POLEA LOCA	
		36091	POLEA DEL TEN	
		38509	SENSOR	
GM V-8, 8.1 L	2006	38256	SENSOR	MOTOR
		38261	SENSOR	COMPRESOR AIRE
CATERPILLAR 3126 DIESEL	2005	36096	POLEA LOCA	
		36091	POLEA DEL TEN	
		38509	SENSOR	
GM V-8, 8.1 L	2005	38256	SENSOR	MOTOR
		38261	SENSOR	COMPRESOR AIRE
CATERPILLAR 3126 DIESEL	2004	36096	POLEA LOCA	
		36091	POLEA DEL TEN	
		38509	SENSOR	
GM V-8, 8.1 L	2004	38261	SENSOR	COMPRESOR AIRE
		38256	SENSOR	MOTOR
CATERPILLAR 3126 DIESEL	2003	36096	POLEA LOCA	
		36091	POLEA DEL TEN	
		38509	SENSOR	
GM V-8, 8.1 L	2003	38261	SENSOR	COMPRESOR AIRE
		38256	SENSOR	MOTOR
CATERPILLAR 3126 DIESEL	2002	36091	POLEA DEL TEN	
		36096	POLEA LOCA	
		38509	SENSOR	



GM V-8, 8.1 L	2002	38256	SENSOR	MOTOR
CATERPILLAR 3126 DIESEL	2001	38261	SENSOR	COMPRESOR AIRE
		36096	POLEA LOCA	
		36091	POLEA DEL TEM	
GM V-8, 8.1 L	2001	38509	SENSOR	
		38261	SENSOR	COMPRESOR AIRE
		38256	SENSOR	MOTOR
CATERPILLAR 3116 DIESEL	2000	36091	POLEA DEL TEM	
		36096	POLEA LOCA	
		38509	SENSOR	
CATERPILLAR 3126 DIESEL	2000	36091	POLEA DEL TEM	
		36096	POLEA LOCA	
		38509	SENSOR	
CATERPILLAR 3116 DIESEL	1999	36096	POLEA LOCA	
		36091	POLEA DEL TEM	
		38509	SENSOR	
CATERPILLAR 3116 DIESEL	1998	36091	POLEA DEL TEM	
		36096	POLEA LOCA	
		38509	SENSOR	
CATERPILLAR 3116 DIESEL	1997	36091	POLEA DEL TEM	
		36096	POLEA LOCA	
		38509	SENSOR	



**T7500**

Isuzu 6HK1-TC Diesel	2008	38579	SENSOR	- Ventilador, Alt. & A.A.
Isuzu 6HK1-TC Diesel	2007	38579	SENSOR	- Ventilador, Alt. & A.A.
Isuzu 6HK1-TC Diesel	2006	38579	SENSOR	- Ventilador, Alt. & A.A.
Isuzu 6HK1-TC Diesel	2005	38579	SENSOR	- Ventilador, Alt. & A.A.

**T8500**

Isuzu 6HK1-TC Diesel	2008	38579	SENSOR	- Ventilador, Alt. & A.A.
Isuzu 6HK1-TC Diesel	2007	38579	SENSOR	- Ventilador, Alt. & A.A.
Isuzu 6HK1-TC Diesel	2006	38579	SENSOR	- Ventilador, Alt. & A.A.
Isuzu 6HK1-TC Diesel	2005	38579	SENSOR	- Ventilador, Alt. & A.A.

**W3500**

GM V-8 6.0 L	2007	38159	SENSOR	- A.A.
GM V-8 6.0 L	2006	38158	SENSOR	- Alt. & E.D.H.
		38009	POLEA	Tensora - Alt. & E.D.H.
		38158	SENSOR	- Alt. & E.D.H.
GM V-8 6.0 L		38159	SENSOR	- A.A.
		38001	POLEA	guía
		38009	POLEA	Tensora - Alt. & E.D.H.

**KODIAK C6500**

Caterpillar 3116 Diesel	1996	36091	POLEA	Tensora
Caterpillar 3116 Diesel	1995	38509	SENSOR	
		36091	POLEA	Tensora
		38509	SENSOR	
Caterpillar 3116 Diesel	1994	36091	POLEA	Tensora
		38509	SENSOR	
		36091	POLEA	Tensora
Caterpillar 3116 Diesel	1993	36091	POLEA	Tensora
		38509	SENSOR	
		36091	POLEA	Tensora
Caterpillar 3116 Diesel	1992	36091	POLEA	Tensora
		38509	SENSOR	
		36091	POLEA	Tensora
Caterpillar 3116 Diesel	1991	36091	POLEA	Tensora
		38509	SENSOR	

**W4500**

GM V-8 6.0 L	2007	38158	SENSOR	- Alt. & E.D.H.
GM V-8 6.0 L	2006	38159	SENSOR	- A.A.
		38009	POLEA	Tensora - Alt. & E.D.H.
		38159	SENSOR	- A.A.
GM V-8 6.0 L		38158	SENSOR	- Alt. & E.D.H.
		38009	POLEA	Tensora - Alt. & E.D.H.

**DINA**

**KODIAK C7500**

Caterpillar 3116 Diesel	1996	36091	POLEA	Tensora
Caterpillar 3116 Diesel	1995	38509	SENSOR	
		36091	POLEA	Tensora
		38509	SENSOR	
Caterpillar 3116 Diesel	1994	36091	POLEA	Tensora
		38509	SENSOR	
		36091	POLEA	Tensora
Caterpillar 3116 Diesel	1993	36091	POLEA	Tensora
		38509	SENSOR	
		36091	POLEA	Tensora
Caterpillar 3116 Diesel	1992	36091	POLEA	Tensora
		38509	SENSOR	
		36091	POLEA	Tensora
Caterpillar 3116 Diesel	1991	36091	POLEA	Tensora
		38509	SENSOR	

**102 F**

CUMMINS ISB	2008	38516	SENSOR	
-------------	------	-------	--------	--

**104-R**

CUMMINS ISB	2008	38516	SENSOR	MOTOR
-------------	------	-------	--------	-------

**104-SF**

CUMMINS ISB	2008	38516	SENSOR	MOTOR
-------------	------	-------	--------	-------

**94 F**

CUMMINS ISB	2008	38516	SENSOR	
-------------	------	-------	--------	--

**FORD**

**E450 SUPER DUTY**

Ford V-10 6.8 L	2007	36157	POLEA	guía - ranurada
Ford V-10 6.8 L		38274	SENSOR	
		38001	POLEA	guía - Lisa
		38006	POLEA	Tensora
		38329	SENSOR	
Ford V-10 6.8 L	2006	36157	POLEA	guía - ranurada
Ford V-10 6.8 L		38329	SENSOR	
		38001	POLEA	guía - Lisa
		38274	SENSOR	
		38257	SENSOR	- Ventilador, Alt., E.D.H. & A.A.
Ford V-8 6.0 L Diesel	2006	38133	SENSOR	
Ford V-10 6.8 L		38001	POLEA	guía
		38023	POLEA	Tensora
		38330	SENSOR	
		38329	SENSOR	
Ford V-8 5.4 L	2005	38329	SENSOR	

**T6500**

Isuzu 6HK1-TC Diesel	2008	38579	SENSOR	- Ventilador, Alt. & A.A.
Isuzu 6HK1-TC Diesel	2007	38579	SENSOR	- Ventilador, Alt. & A.A.
Isuzu 6HK1-TC Diesel	2006	38579	SENSOR	- Ventilador, Alt. & A.A.
Isuzu 6HK1-TC Diesel	2005	38579	SENSOR	- Ventilador, Alt. & A.A.





Ford V-8 7.3 L Diesel	2004	38053	POLEA	Tensora - ranurada	
Ford V-10 6.8 L	2003	36157	POLEA	guía - ranurada	
		38274	TENSOR		
		38001	POLEA	guía - Lisa	
		38329	TENSOR		
Ford V-8 6.0 L Diesel	2003	38257	TENSOR	- Ventilador, Alt., E.D.H. & A.A.	
Ford V-8 7.3 L Diesel	2003	38191	TENSOR		
		38028	POLEA	Tensora - Lisa	
		38053	POLEA	Tensora - ranurada	
Ford V-10 6.8 L	2002	36157	POLEA	guía - ranurada	
		38329	TENSOR		
		38001	POLEA	guía - Lisa	
		38274	TENSOR		
Ford V-8 7.3 L Diesel	2002	38191	TENSOR		
		38028	POLEA	Tensora - Lisa	
		38053	POLEA	Tensora - ranurada	
Ford V-10 6.8 L	2001	38133	TENSOR		
		38330	TENSOR		
		38022	POLEA	guía	
		38023	POLEA	Tensora	
		38023	POLEA	Tensora - Lisa	
Ford V-8 7.3 L Diesel	2001	38191	TENSOR		
		38053	POLEA	Tensora - ranurada	
		38028	POLEA	Tensora - Lisa	
Ford V-10 6.8 L	2000	38133	TENSOR		
		38022	POLEA	guía	
		38023	POLEA	Tensora	
		38023	POLEA	Tensora - Lisa	
Ford V-8 7.3 L Diesel	2000	38330	TENSOR		
		38191	TENSOR		
		38028	POLEA	Tensora - Lisa	
		38053	POLEA	Tensora - ranurada	
Ford V-10 6.8 L	1999	38133	TENSOR		
		38023	POLEA	Tensora	
		38023	POLEA	Tensora - Lisa	
		38330	TENSOR		
		38022	POLEA	guía	
Ford V-8 7.3 L Diesel	1999	38191	TENSOR		
		38053	POLEA	Tensora - ranurada	
		38028	POLEA	Tensora - Lisa	

Caterpillar 3126 Diesel	2002	36091	POLEA	Tensora - Ventilador, Alt. & A.A.	
		38506	TENSOR	- Ventilador, Alt. & A.A.	
Cummins ISB Diesel	2002	36093	POLEA	Tensora - Ventilador, B.A. & Alt.	
		38516	TENSOR	- Ventilador, B.A. & Alt.	
Ford V-8 7.3 L Diesel	2002	38191	TENSOR		
		38028	POLEA	Tensora - Lisa	
		38053	POLEA	Tensora - ranurada	
Caterpillar 3126 Diesel	2001	36091	POLEA	Tensora - Ventilador, Alt. & A.A.	
		38506	TENSOR	- Ventilador, Alt. & A.A.	
Cummins ISB Diesel	2001	36093	POLEA	Tensora - Ventilador & A.A.	
		38516	TENSOR	- Ventilador & A.A.	
Ford V-8 7.3 L Diesel	2001	38191	TENSOR		
		38028	POLEA	Tensora - Lisa	
		38053	POLEA	Tensora - ranurada	
Caterpillar 3126 Diesel	2000	36091	POLEA	Tensora - Ventilador, Alt. & A.A.	
		38506	TENSOR	- Ventilador, Alt. & A.A.	
Cummins ISB Diesel	2000	36093	POLEA	Tensora - Ventilador & A.A.	
		38516	TENSOR	- Ventilador & A.A.	
Ford V-8 7.3 L Diesel	2000	38191	TENSOR		
		38028	POLEA	Tensora - Lisa	
		38053	POLEA	Tensora - ranurada	

**F750 SUPER DUTY**

Cummins ISB Diesel	2007	38517	TENSOR	- B.A., Alt. & A.A.
Caterpillar C7 Diesel	2006	38550	TENSOR	- Ventilador, Alt. & A.A.
Cummins ISB Diesel	2006	38517	TENSOR	- B.A., Alt. & A.A.
Ford V-8 6.0 L Diesel	2006	38556	TENSOR	- Ventilador, Alt. & A.A.
Caterpillar C7 Diesel	2005	38550	TENSOR	- Ventilador, Alt. & A.A.
Cummins ISB Diesel	2005	38517	TENSOR	- B.A., Alt. & A.A.
Ford V-8 6.0 L Diesel	2005	38556	TENSOR	- Ventilador, Alt. & A.A.
Caterpillar 3126 Diesel	2004	36091	POLEA	Tensora - Ventilador, Alt. & A.A.
		38506	TENSOR	- Ventilador, Alt. & A.A.
Caterpillar C7 Diesel	2004	38550	TENSOR	- Ventilador, Alt. & A.A.
Cummins ISB Diesel	2004	36093	POLEA	Tensora - Ventilador, B.A. & Alt.
		38516	TENSOR	- Ventilador, B.A. & Alt.
Ford V-8 6.0 L Diesel	2004	38556	TENSOR	- Ventilador, Alt. & A.A.
Ford V-8 7.3 L Diesel	2004	38191	TENSOR	
		38028	POLEA	Tensora - Lisa
		38053	POLEA	Tensora - ranurada
Caterpillar 3126 Diesel	2003	36091	POLEA	Tensora - Ventilador, Alt. & A.A.
		38506	TENSOR	- Ventilador, Alt. & A.A.
Cummins ISB Diesel	2003	36093	POLEA	Tensora - Ventilador, B.A. & Alt.
Ford V-8 6.0 L Diesel	2003	38556	TENSOR	- Ventilador, Alt. & A.A.
Ford V-8 7.3 L Diesel	2003	38191	TENSOR	
		38028	POLEA	Tensora - Lisa
		38053	POLEA	Tensora - ranurada
Caterpillar 3126 Diesel	2002	36091	POLEA	Tensora - Ventilador, Alt. & A.A.
		38506	TENSOR	- Ventilador, Alt. & A.A.
Cummins ISB Diesel	2002	36093	POLEA	Tensora - Ventilador, B.A. & Alt.
		38516	TENSOR	- Ventilador, B.A. & Alt.
Ford V-8 7.3 L Diesel	2002	38191	TENSOR	
		38028	POLEA	Tensora - Lisa
		38053	POLEA	Tensora - ranurada
Caterpillar 3126 Diesel	2001	36091	POLEA	Tensora - Ventilador, Alt. & A.A.
		38506	TENSOR	- Ventilador, Alt. & A.A.
Cummins ISB Diesel	2001	36093	POLEA	Tensora - Ventilador & A.A.
		38516	TENSOR	- Ventilador & A.A.
Ford V-8 7.3 L Diesel	2001	38191	TENSOR	
		38028	POLEA	Tensora - Lisa
		38053	POLEA	Tensora - ranurada
Caterpillar 3126 Diesel	2000	36091	POLEA	Tensora - Ventilador, Alt. & A.A.
		38506	TENSOR	- Ventilador, Alt. & A.A.
Cummins ISB Diesel	2000	36093	POLEA	Tensora - Ventilador, Alt. & Toma Fuerza
		38516	TENSOR	- Ventilador, Alt. & Toma Fuerza
Ford V-8 7.3 L Diesel	2000	38191	TENSOR	
		38028	POLEA	Tensora - Lisa
		38053	POLEA	Tensora - ranurada

**F600**

Cummins B Series 5.9 L Diesel	1994	36095	POLEA	Tensora - Ventilador & Alt.
		38517	TENSOR	- Ventilador & Alt.
Cummins B Series 5.9 L Diesel	1993	38517	TENSOR	- Ventilador & Alt.
		36095	POLEA	Tensora - Ventilador & Alt.
Cummins B Series 5.9 L Diesel	1992	38517	TENSOR	- Ventilador & Alt.
		36095	POLEA	Tensora - Ventilador & Alt.

**F650 SUPER DUTY**

Cummins ISB Diesel	2007	38517	TENSOR	- B.A., Alt. & A.A.
Caterpillar C7 Diesel	2006	38550	TENSOR	- Ventilador, Alt. & A.A.
Cummins ISB Diesel	2006	38517	TENSOR	- B.A., Alt. & A.A.
Ford V-8 6.0 L Diesel	2006	38556	TENSOR	- Ventilador, Alt. & A.A.
Caterpillar C7 Diesel	2005	38550	TENSOR	- Ventilador, Alt. & A.A.
Cummins ISB Diesel	2005	38517	TENSOR	- B.A., Alt. & A.A.
Ford V-8 6.0 L Diesel	2005	38556	TENSOR	- Ventilador, Alt. & A.A.
Caterpillar 3126 Diesel	2004	36091	POLEA	Tensora - Ventilador, Alt. & A.A.
		38506	TENSOR	- Ventilador, Alt. & A.A.
Caterpillar C7 Diesel	2004	38550	TENSOR	- Ventilador, Alt. & A.A.
Cummins ISB Diesel	2004	36093	POLEA	Tensora - Ventilador, B.A. & Alt.
		38516	TENSOR	- Ventilador, B.A. & Alt.
Ford V-8 6.0 L Diesel	2004	38556	TENSOR	- Ventilador, Alt. & A.A.
Ford V-8 7.3 L Diesel	2004	38191	TENSOR	
		38028	POLEA	Tensora - Lisa
		38053	POLEA	Tensora - ranurada
Caterpillar 3126 Diesel	2003	36091	POLEA	Tensora - Ventilador, Alt. & A.A.
		38506	TENSOR	- Ventilador, Alt. & A.A.
Cummins ISB Diesel	2003	36093	POLEA	Tensora - Ventilador, B.A. & Alt.
		38516	TENSOR	- Ventilador, B.A. & Alt.
Ford V-8 6.0 L Diesel	2003	38556	TENSOR	- Ventilador, Alt. & A.A.
Ford V-8 7.3 L Diesel	2003	38191	TENSOR	
		38028	POLEA	Tensora - Lisa
		38053	POLEA	Tensora - ranurada

**F800**

CUMMINS ISB DIESEL	1998	38517	TENSOR	Toma de Fuerza, Ven, Alt., y A.A.
--------------------	------	-------	--------	-----------------------------------



**FREIGHTLINER**

**ARGOSY**

Detroit Diesel 6-Cyl. 12.7 L Diesel	2006	38076	POLEA	Tensora - Ventilador	Caterpillar C12 Diesel		36091	POLEA	Tensora - Ventilador a A.A.
		38501	TENSOR	- Alt. & A.A.			36091	POLEA	Tensora - Ventilador, Alt. & Toma Fuerza
		38075	POLEA	Tensora - Alt. & A.A.			36091	POLEA	guía - Ventilador & Alt.
		38503	TENSOR	- Ventilador			38524	TENSOR	- Ventilador a A.A.
Detroit Diesel 6-Cyl. 14.0 L Diesel	2006	38076	POLEA	Tensora - Ventilador			38506	TENSOR	- Ventilador, Alt. & Toma Fuerza
		38075	POLEA	Tensora - Alt. & A.A.			36091	POLEA	Tensora - Ventilador a A.A.
		38503	TENSOR	- Ventilador			36091	POLEA	Tensora - Ventilador & Alt.
Detroit Diesel 6-Cyl. 12.7 L Diesel	2005	38076	POLEA	Tensora - Ventilador			38508	TENSOR	- Ventilador a A.A.
		38503	TENSOR	- Ventilador			38506	TENSOR	- Ventilador a A.A.
		38501	TENSOR	- Alt. & A.A.			38506	TENSOR	- Ventilador a A.A.
Detroit Diesel 6-Cyl. 14.0 L Diesel	2005	38076	POLEA	Tensora - Ventilador			38501	TENSOR	Tensora - Ventilador a A.A.
		38075	POLEA	Tensora - Alt. & A.A.			38501	TENSOR	Tensora - Ventilador a A.A.
		38503	TENSOR	- Ventilador			38506	TENSOR	Tensora - Ventilador a A.A.
		38501	TENSOR	- Alt. & A.A.			38506	TENSOR	Tensora - Ventilador a A.A.
Caterpillar C12 Diesel	2004	36091	POLEA	Tensora - Ventilador, Alt. & Toma Fuerza			38524	TENSOR	Tensora - Ventilador a A.A.
		36091	POLEA	Tensora - Ventilador a A.A.			36091	POLEA	Tensora - Ventilador a A.A.
		38506	TENSOR	guía - Ventilador & Alt.			36091	POLEA	Tensora - Ventilador, Alt. & Toma Fuerza
		38524	TENSOR	- Ventilador a A.A.			38524	TENSOR	Tensora - Ventilador, Alt. & Toma Fuerza
Caterpillar C15 Diesel	2004	36091	POLEA	Tensora - Ventilador & Alt.			36091	POLEA	Tensora - Ventilador a A.A.
		36091	POLEA	Tensora - Ventilador a A.A.			38524	TENSOR	Tensora - Ventilador a A.A.
		38506	TENSOR	- Ventilador & Alt.			38506	TENSOR	Tensora - Ventilador, Alt. & Toma Fuerza
		38508	TENSOR	- Ventilador a A.A.			38506	TENSOR	Tensora - Ventilador, Alt. & Toma Fuerza
Detroit Diesel 6-Cyl. 12.7 L Diesel	2004	38076	POLEA	Tensora - Ventilador			36091	POLEA	Tensora - Ventilador a A.A.
		38501	TENSOR	- Alt. & A.A.			36091	POLEA	Tensora - Ventilador a A.A.
		38503	TENSOR	- Ventilador			38508	TENSOR	- Ventilador a A.A.
		38075	POLEA	Tensora - Alt. & A.A.			38506	TENSOR	- Ventilador & Alt.
Detroit Diesel 6-Cyl. 14.0 L Diesel	2004	38076	POLEA	Tensora - Ventilador			36092	POLEA	Tensora - Ventilador
		38501	TENSOR	- Alt. & A.A.			38535	TENSOR	- Ventilador
		38503	TENSOR	- Ventilador			38532	TENSOR	- Toma Fuerza, Alt. & A.A.
		38075	POLEA	Tensora - Alt. & A.A.			36095	POLEA	Tensora - Toma Fuerza, Alt. & A.A.
		38076	POLEA	Tensora - Ventilador			38076	POLEA	Tensora - Ventilador
		38501	TENSOR	- Alt. & A.A.			38501	TENSOR	- Alt. & A.A.
		38503	TENSOR	- Ventilador			38503	TENSOR	- Ventilador
		38075	POLEA	Tensora - Alt. & A.A.			38075	POLEA	Tensora - Alt. & A.A.
Caterpillar C10 Diesel	2003	36091	POLEA	Tensora - Ventilador a A.A.			38075	POLEA	Tensora - Alt. & A.A.
		36091	POLEA	Tensora - Ventilador, Alt. & Toma Fuerza			38075	POLEA	Tensora - Alt. & A.A.
		36091	POLEA	guía - Ventilador & Alt.			38075	POLEA	Tensora - Alt. & A.A.
		38506	TENSOR	- Ventilador, Alt. & Toma Fuerza			38075	POLEA	Tensora - Alt. & A.A.
		38524	TENSOR	- Ventilador a A.A.			38501	TENSOR	- Alt. & A.A.
Caterpillar C12 Diesel	2003	36091	POLEA	Tensora - Ventilador a A.A.			38503	TENSOR	- Ventilador
		36091	POLEA	Tensora - Ventilador, Alt. & Toma Fuerza			38076	POLEA	Tensora - Ventilador
		38506	TENSOR	guía - Ventilador & Alt.			36091	POLEA	Tensora - Ventilador a A.A.
		38506	TENSOR	- Ventilador, Alt. & Toma Fuerza			36091	POLEA	guía - Ventilador & Alt.
		38524	TENSOR	- Ventilador a A.A.			36091	POLEA	Tensora - Ventilador, Alt. & Toma Fuerza
Caterpillar C15 Diesel	2003	36091	POLEA	Tensora - Ventilador & Alt.			38506	TENSOR	Tensora - Ventilador, Alt. & Toma Fuerza
		36091	POLEA	Tensora - Ventilador a A.A.			38524	TENSOR	- Ventilador a A.A.
		38506	TENSOR	- Ventilador & Alt.			36091	POLEA	Tensora - Ventilador a A.A.
		38508	TENSOR	- Ventilador a A.A.			36091	POLEA	Tensora - Ventilador, Alt. & Toma Fuerza
Cummins ISX Diesel	2003	36092	POLEA	Tensora - Ventilador			36091	POLEA	Tensora - Ventilador, Alt. & Toma Fuerza
		38532	TENSOR	- Toma Fuerza, Alt. & A.A.			38506	TENSOR	Tensora - Ventilador, Alt. & Toma Fuerza
		38535	TENSOR	- Ventilador			38524	TENSOR	- Ventilador a A.A.
		36095	POLEA	Tensora - Toma Fuerza, Alt. & A.A.			36091	POLEA	Tensora - Ventilador a A.A.
Detroit Diesel 6-Cyl. 11.1 L Diesel	2003	38076	POLEA	Tensora - Ventilador			36092	POLEA	Tensora - Ventilador
		38503	TENSOR	- Ventilador			38532	TENSOR	- Toma Fuerza, Alt. & A.A.
		38501	TENSOR	- Alt. & A.A.			38535	TENSOR	- Ventilador
		38075	POLEA	Tensora - Alt. & A.A.			36095	POLEA	Tensora - Toma Fuerza, Alt. & A.A.
Detroit Diesel 6-Cyl. 12.7 L Diesel	2003	38076	POLEA	Tensora - Ventilador			38076	POLEA	Tensora - Ventilador
		38503	TENSOR	- Ventilador			38075	POLEA	Tensora - Alt. & A.A.
		38075	POLEA	Tensora - Alt. & A.A.			38503	TENSOR	- Ventilador
		38075	POLEA	Tensora - Alt. & A.A.			38501	TENSOR	- Alt. & A.A.
		38501	TENSOR	- Alt. & A.A.			38503	TENSOR	- Ventilador
Detroit Diesel 6-Cyl. 14.0 L Diesel	2003	38076	POLEA	Tensora - Ventilador			38075	POLEA	Tensora - Alt. & A.A.
		38503	TENSOR	- Ventilador			38501	TENSOR	- Alt. & A.A.
		38501	TENSOR	- Alt. & A.A.			38503	TENSOR	- Ventilador
		38075	POLEA	Tensora - Alt. & A.A.			38075	POLEA	Tensora - Alt. & A.A.
		38501	TENSOR	- Alt. & A.A.			38501	TENSOR	- Alt. & A.A.
Caterpillar C10 Diesel	2002	36091	POLEA	Tensora - Ventilador a A.A.			38076	POLEA	Tensora - Ventilador
		36091	POLEA	Tensora - Ventilador, Alt. & Toma Fuerza			36091	POLEA	Tensora - Ventilador, Alt. & Toma Fuerza
		36091	POLEA	guía - Ventilador & Alt.			36092	POLEA	Tensora - Ventilador
		38506	TENSOR	- Ventilador, Alt. & Toma Fuerza			36095	POLEA	Tensora - Ventilador
		38524	TENSOR	- Ventilador a A.A.			38535	TENSOR	Tensora - Toma Fuerza, Alt. & A.A.

Cummins ISX Diesel	1999	38532	SENSOR	- Toma Fuerza, Alt. & A.A.
Detroit Diesel 6-Cyl. 11.1 L Diesel	1999	38501	SENSOR	- Toma Fuerza, Alt. & A.A.
		38075	POLEA	Tensora - Toma Fuerza, Alt. & A.A.
Detroit Diesel 6-Cyl. 12.7 L Diesel	1999	38075	POLEA	Tensora - Toma Fuerza, Alt. & A.A.
		38501	SENSOR	- Toma Fuerza, Alt. & A.A.

Caterpillar C11 Diesel	2006	38075	POLEA	Tensora - Toma Fuerza, Alt. & A.A.
Caterpillar C13 Diesel	2006	38503	SENSOR	- Ventilador
		38590	SENSOR	- Ventilador, Alt. & A.A.
Caterpillar C15 Diesel	2006	36093	POLEA	guía - ranurada
		38590	SENSOR	- Ventilador, Alt. & A.A.

**BUSINESS CLASS M2**

Mercedes-Benz MBE 900 Diesel	2008	38567	SENSOR	- Alt. & A.A.
Caterpillar 3126 Diesel	2007	38550	SENSOR	- Ventilador, Alt. & A.A.
		36091	POLEA	guía - Lisa
		36096	POLEA	guía
		38590	SENSOR	- Toma Fuerza, Ventilador, Alt. & A.A.
Caterpillar C13 Diesel	2007	36093	POLEA	guía - ranurada
		38550	SENSOR	- Ventilador, Alt. & A.A.
		36091	POLEA	guía - Lisa
		36096	POLEA	guía
Caterpillar C7 Diesel	2007	38550	SENSOR	- Ventilador, Alt. & A.A.
		38597	SENSOR	- Ventilador
		38501	SENSOR	- Toma Fuerza, Alt. & A.A.
		38075	POLEA	Tensora - Toma Fuerza, Alt. & A.A.
Mercedes-Benz MBE 4000 Diesel	2007	38597	SENSOR	- Ventilador
		38501	SENSOR	- Toma Fuerza, Alt. & A.A.
		38075	POLEA	Tensora - Toma Fuerza, Alt. & A.A.
		38598	SENSOR	- Ventilador
Mercedes-Benz MBE 900 Diesel	2007	38598	SENSOR	- Ventilador
		38567	SENSOR	- Alt. & A.A.
		38590	SENSOR	- Toma Fuerza, Ventilador, Alt. & A.A.
		36093	POLEA	guía - ranurada
Caterpillar C13 Diesel	2006	38550	SENSOR	- Ventilador, Alt. & A.A.
		36091	POLEA	guía - Lisa
		38550	SENSOR	- Ventilador, Alt. & A.A.
		38516	SENSOR	- Toma Fuerza, Ventilador, Alt. & A.A.
Cummins ISC Diesel	2006	38597	SENSOR	- Ventilador
		38501	SENSOR	- Toma Fuerza, Alt. & A.A.
		38075	POLEA	Tensora - Toma Fuerza, Alt. & A.A.
		38598	SENSOR	- Ventilador
Mercedes-Benz MBE 900 Diesel	2006	38598	SENSOR	- Ventilador
		38567	SENSOR	- Alt. & A.A.
		38590	SENSOR	- Toma Fuerza, Ventilador, Alt. & A.A.
		36093	POLEA	guía - ranurada
Caterpillar C7 Diesel	2006	38550	SENSOR	- Ventilador, Alt. & A.A.
		36091	POLEA	guía - Lisa
		38550	SENSOR	- Ventilador, Alt. & A.A.
		38516	SENSOR	- Toma Fuerza, Ventilador, Alt. & A.A.
Mercedes-Benz MBE 4000 Diesel	2006	38597	SENSOR	- Ventilador
		38501	SENSOR	- Toma Fuerza, Alt. & A.A.
		38075	POLEA	Tensora - Toma Fuerza, Alt. & A.A.
		38597	SENSOR	- Ventilador
Mercedes-Benz MBE 900 Diesel	2006	38597	SENSOR	- Ventilador
		38501	SENSOR	- Toma Fuerza, Alt. & A.A.
		38075	POLEA	Tensora - Toma Fuerza, Alt. & A.A.
		38598	SENSOR	- Ventilador
Caterpillar C13 Diesel	2005	38590	SENSOR	- Toma Fuerza, Ventilador, Alt. & A.A.
		36093	POLEA	guía - ranurada
		38550	SENSOR	- Ventilador, Alt. & A.A.
		36091	POLEA	guía - Lisa
Caterpillar C7 Diesel	2005	38550	SENSOR	- Ventilador, Alt. & A.A.
		38597	SENSOR	- Ventilador
		38501	SENSOR	- Toma Fuerza, Alt. & A.A.
		38075	POLEA	Tensora - Toma Fuerza, Alt. & A.A.
Mercedes-Benz MBE 900 Diesel	2005	38567	SENSOR	- Ventilador, Alt. & A.A.
		38550	SENSOR	- Toma Fuerza, Ventilador, Alt. & A.A.
		38590	SENSOR	- Ventilador, Alt. & A.A.
		36093	POLEA	guía - ranurada
Caterpillar C13 Diesel	2004	38550	SENSOR	- Ventilador, Alt. & A.A.
		38590	SENSOR	- Toma Fuerza, Ventilador, Alt. & A.A.
		36093	POLEA	guía - ranurada
		38597	SENSOR	- Ventilador
Caterpillar C7 Diesel	2004	38550	SENSOR	- Ventilador, Alt. & A.A.
		36091	POLEA	guía - Lisa
		38550	SENSOR	- Ventilador, Alt. & A.A.
		36093	POLEA	Tensora - Ventilador & Alt.
Cummins ISC Diesel	2004	38516	SENSOR	- Ventilador & Alt.
		38597	SENSOR	- Ventilador
		38501	SENSOR	- Toma Fuerza, Alt. & A.A.
		38075	POLEA	Tensora - Toma Fuerza, Alt. & A.A.
Mercedes-Benz MBE 4000 Diesel	2004	38567	SENSOR	- Ventilador, Alt. & A.A.
		38550	SENSOR	- Ventilador, Alt. & A.A.
		38597	SENSOR	- Ventilador
		38501	SENSOR	- Toma Fuerza, Alt. & A.A.
Mercedes-Benz MBE 900 Diesel	2004	38567	SENSOR	- Ventilador, Alt. & A.A.
		38550	SENSOR	- Ventilador, Alt. & A.A.
		38597	SENSOR	- Ventilador
		38501	SENSOR	- Toma Fuerza, Alt. & A.A.
Caterpillar 3126 Diesel	2003	38550	SENSOR	- Ventilador, Alt. & A.A.
		38550	SENSOR	- Ventilador, Alt. & A.A.
		38597	SENSOR	- Ventilador
		38501	SENSOR	- Toma Fuerza, Alt. & A.A.
Caterpillar 3126 Diesel	2002	38550	SENSOR	- Ventilador, Alt. & A.A.
		38550	SENSOR	- Ventilador, Alt. & A.A.
		38597	SENSOR	- Ventilador
		38501	SENSOR	- Toma Fuerza, Alt. & A.A.

Caterpillar C11 Diesel	2005	36093	POLEA	guía - ranurada
		36093	POLEA	guía - ranurada
		38569	SENSOR	- Ventilador & Alt.
		36091	POLEA	Tensora - Ventilador a A.A.
Caterpillar C13 Diesel	2005	36093	POLEA	guía - ranurada
		38569	SENSOR	- Ventilador & Alt.
		36091	POLEA	Tensora - Ventilador a A.A.
		36093	POLEA	guía - ranurada
Caterpillar C15 Diesel	2005	38569	SENSOR	- Ventilador & Alt.
		36091	POLEA	Tensora - Ventilador a A.A.
		36093	POLEA	guía - ranurada
		36091	POLEA	guía - Lisa
Detroit Diesel 6-Cyl. 12.7 L Diesel	2005	38511	SENSOR	- Ventilador a A.A.
		38076	POLEA	Tensora - Ventilador
		38501	SENSOR	- Toma Fuerza, Alt. & A.A.
		38503	SENSOR	- Ventilador
Detroit Diesel 6-Cyl. 14.0 L Diesel	2005	38076	POLEA	Tensora - Ventilador
		38503	SENSOR	- Ventilador
		38075	POLEA	Tensora - Toma Fuerza, Alt. & A.A.
		38501	SENSOR	- Toma Fuerza, Alt. & A.A.
DETROIT DIESEL SERIE 60	2005	38076	POLEA	Vent.
		38075	POLEA	Toma de Fuerza, Alt.; C/AA
		38501	SENSOR	Alt., Toma de Fuerza, C/AA
		38503	SENSOR	Vent.
Mercedes-Benz MBE 4000 Diesel	2005	38597	SENSOR	- Ventilador
		38501	SENSOR	- Toma Fuerza, Alt. & A.A.
		38075	POLEA	Tensora - Ventilador
		36093	POLEA	guía - ranurada
Caterpillar C11 Diesel	2004	36091	POLEA	Tensora - Ventilador a A.A.
		36091	POLEA	guía - Ventilador & Alt.
		38524	SENSOR	- Ventilador a A.A.
		38506	SENSOR	- Ventilador & Alt.
Caterpillar C12 Diesel	2004	36091	POLEA	guía - ranurada
		36091	POLEA	guía - Ventilador a A.A.
		36091	POLEA	guía - Lisa
		36093	POLEA	guía - ranurada
Caterpillar C13 Diesel	2004	36091	POLEA	Tensora - Ventilador & Alt.
		36091	POLEA	Tensora - Ventilador a A.A.
		36091	POLEA	guía - Lisa
		36093	POLEA	guía - ranurada
Caterpillar C15 Diesel	2004	36091	POLEA	Tensora - Ventilador a A.A.
		36091	POLEA	guía - Lisa
		36093	POLEA	guía - ranurada
		36091	POLEA	Tensora - Ventilador & Alt.
Detroit Diesel 6-Cyl. 12.7 L Diesel	2004	38508	SENSOR	- Ventilador a A.A.
		38506	SENSOR	- Ventilador & Alt.
		38076	POLEA	Tensora - Ventilador
		38075	POLEA	Tensora - Toma Fuerza, Alt. & A.A.
Detroit Diesel 6-Cyl. 14.0 L Diesel	2004	38501	SENSOR	- Toma Fuerza, Alt. & A.A.
		38503	SENSOR	- Ventilador
		38076	POLEA	Tensora - Ventilador
		38503	SENSOR	- Ventilador
Mercedes-Benz MBE 4000 Diesel	2004	38540	SENSOR	- Toma Fuerza, Alt. & A.A.
		38075	POLEA	Tensora - Toma Fuerza, Alt. & A.A.
		38541	SENSOR	- A.A.
		38540	SENSOR	- Toma Fuerza & Alt.
Caterpillar C10 Diesel	2003	36091	POLEA	Tensora - Ventilador a A.A.
		36091	POLEA	guía - Ventilador & Alt.
		38506	SENSOR	- Ventilador & Alt.
		38524	SENSOR	- Ventilador a A.A.
Caterpillar C12 Diesel	2003	36091	POLEA	Tensora - Ventilador a A.A.
		36091	POLEA	guía - Ventilador & Alt.
		38524	SENSOR	- Ventilador a A.A.
		38506	SENSOR	- Ventilador & Alt.
Caterpillar C15 Diesel	2003	36091	POLEA	Tensora - Ventilador & Alt.
		36091	POLEA	Tensora - Ventilador a A.A.
		38506	SENSOR	- Ventilador & Alt.
		38508	SENSOR	- Ventilador a A.A.

**CASCADIA**

Detroit Diesel 6-Cyl. 14.0 L Diesel	2008	38076	POLEA	Tensora - Ventilador
		38503	SENSOR	- Ventilador
		38075	POLEA	Tensora - Alt. & A.A.
		38501	SENSOR	- Alt. & A.A.

Mercedes-Benz MBE 4000 Diesel	2004	38540	SENSOR	- Toma Fuerza, Alt. & A.A.
		38541	SENSOR	- A.A.
		36091	POLEA	Tensora - Ventilador a A.A.
		36091	POLEA	guía - Ventilador & Alt.

**CENTURY CLASS**

Caterpillar C13 Diesel	2007	36093	POLEA	guía - ranurada
Caterpillar C15 Diesel	2007	36091	POLEA	guía - Lisa
		36093	POLEA	guía - ranurada
		38076	POLEA	Tensora - Ventilador
Detroit Diesel 6-Cyl. 12.7 L Diesel	2007	38501	SENSOR	- Toma Fuerza, Alt. & A.A.
		38503	SENSOR	- Ventilador
		38075	POLEA	Tensora - Toma Fuerza, Alt. & A.A.
		38076	POLEA	Tensora - Ventilador
Detroit Diesel 6-Cyl. 14.0 L Diesel	2007	38076	POLEA	Tensora - Ventilador
		38501	SENSOR	- Toma Fuerza, Alt. & A.A.

Caterpillar C12 Diesel	2003	36091	POLEA	Tensora - Ventilador a A.A.
		36091	POLEA	guía - Ventilador & Alt.
		38524	SENSOR	- Ventilador a A.A.
		38506	SENSOR	- Ventilador & Alt.
Caterpillar C15 Diesel	2003	36091	POLEA	Tensora - Ventilador & Alt.
		36091	POLEA	Tensora - Ventilador a A.A.
		38506	SENSOR	- Ventilador & Alt.
		38508	SENSOR	- Ventilador a A.A.

Detroit Diesel 6-Cyl. 11.1 L Diesel	2003	38501	SENSOR	- Toma Fuerza, Alt. & A.A.
		38075	POLEA	Tensora - Toma Fuerza, Alt. & A.A.
Detroit Diesel 6-Cyl. 12.7 L Diesel	2003	38501	SENSOR	- Toma Fuerza, Alt. & A.A.
		38075	POLEA	Tensora - Toma Fuerza, Alt. & A.A.
Detroit Diesel 6-Cyl. 14.0 L Diesel	2003	38501	SENSOR	- Toma Fuerza, Alt. & A.A.
		38075	POLEA	Tensora - Toma Fuerza, Alt. & A.A.
DETROIT DIESEL SERIE 60	2003	38506	SENSOR	
		38501	SENSOR	Alt.; Toma de Fuerza, A.A.
		38075	POLEA	Alt.; Toma de Fuerza, A.A.
Caterpillar C10 Diesel	2002	36091	POLEA	guía - Ventilador & Alt.
		36091	POLEA	Tensora - Ventilador a A.A.
		36091	POLEA	Tensora - Ventilador & Alt.
		38506	SENSOR	- Ventilador & Alt.
		38524	SENSOR	- Ventilador a A.A.
Caterpillar C12 Diesel	2002	36091	POLEA	Tensora - Ventilador & Alt.
		36091	POLEA	guía - Ventilador & Alt.
		36091	POLEA	Tensora - Ventilador a A.A.
		38506	SENSOR	- Ventilador & Alt.
		38524	SENSOR	- Ventilador a A.A.
Caterpillar C15 Diesel	2002	36091	POLEA	Tensora - Ventilador a A.A.
		36091	POLEA	Tensora - Ventilador & Alt.
		38508	SENSOR	- Ventilador a A.A.
		38506	SENSOR	- Ventilador & Alt.
Detroit Diesel 6-Cyl. 11.1 L Diesel	2002	38075	POLEA	Tensora - Toma Fuerza, Alt. & A.A.
		38501	SENSOR	- Toma Fuerza, Alt. & A.A.
Detroit Diesel 6-Cyl. 12.7 L Diesel	2002	38501	SENSOR	- Toma Fuerza, Alt. & A.A.
		38075	POLEA	Tensora - Toma Fuerza, Alt. & A.A.
DETROIT DIESEL SERIE 60	2002	38075	POLEA	Alt.; Toma de Fuerza, A.A.
		38501	SENSOR	Alt.; Toma de Fuerza, A.A.
Caterpillar C10 Diesel	2001	36091	POLEA	Tensora - Ventilador & Alt.
		36091	POLEA	guía - Ventilador & Alt.
		36091	POLEA	Tensora - Ventilador a A.A.
		38506	SENSOR	- Ventilador & Alt.
		38524	SENSOR	- Ventilador a A.A.
Caterpillar C12 Diesel	2001	36091	POLEA	guía - Ventilador & Alt.
		36091	POLEA	Tensora - Ventilador & Alt.
		36091	POLEA	Tensora - Ventilador a A.A.
		38524	SENSOR	- Ventilador a A.A.
		38506	SENSOR	- Ventilador & Alt.
Caterpillar C15 Diesel	2001	36091	POLEA	Tensora - Ventilador & Alt.
		36091	POLEA	Tensora - Ventilador a A.A.
		38508	SENSOR	- Ventilador a A.A.
		38506	SENSOR	- Ventilador & Alt.
Cummins ISM Diesel	2001	36091	POLEA	Tensora - A.A.
		38521	SENSOR	- Ventilador & Alt.
		38505	SENSOR	- Toma Fuerza & A.A.
Cummins ISX Diesel	2001	36092	POLEA	Tensora - Ventilador & Toma Fuerza
		38535	SENSOR	- Ventilador & Toma Fuerza
		36095	POLEA	Tensora - Toma Fuerza, Alt. & A.A.
		38532	SENSOR	- Toma Fuerza, Alt. & A.A.
Detroit Diesel 6-Cyl. 11.1 L Diesel	2001	38075	POLEA	Tensora - Toma Fuerza, Alt. & A.A.
		38501	SENSOR	- Toma Fuerza, Alt. & A.A.
Detroit Diesel 6-Cyl. 12.7 L Diesel	2001	38075	POLEA	Tensora - Toma Fuerza, Alt. & A.A.
		38501	SENSOR	- Toma Fuerza, Alt. & A.A.
Mercedes-Benz MBE 4000 Diesel	2001	38075	POLEA	Tensora - A.A.
		38501	SENSOR	- A.A.
Caterpillar C10 Diesel	2000	36091	POLEA	Tensora - Ventilador, Alt. & Toma Fuerza
		36091	POLEA	guía - Ventilador & Alt.
		38092	POLEA	Tensora - Alt. & A.A.
		38506	SENSOR	- Ventilador, Alt. & Toma Fuerza
		38534	SENSOR	- Ventilador & A.A.
Caterpillar C12 Diesel	2000	36091	POLEA	Tensora - Ventilador, Alt. & Toma Fuerza
		36091	POLEA	guía - Ventilador & Alt.
		38092	POLEA	Tensora - Alt. & A.A.
		38534	SENSOR	- Ventilador & A.A.
		38506	SENSOR	- Ventilador, Alt. & Toma Fuerza
Cummins ISM Diesel	2000	36091	POLEA	Tensora - A.A.
		38521	SENSOR	- Ventilador & Alt.
		38505	SENSOR	- Toma Fuerza & A.A.
Cummins ISX Diesel	2000	36092	POLEA	Tensora - Ventilador
		38535	SENSOR	- Ventilador
		36095	POLEA	Tensora - Toma Fuerza, Alt. & A.A.
		38532	SENSOR	- Toma Fuerza, Alt. & A.A.
Detroit Diesel 6-Cyl. 11.1 L Diesel	2000	38075	POLEA	Tensora - Toma Fuerza, Alt. & A.A.
		38501	SENSOR	- Toma Fuerza, Alt. & A.A.

Detroit Diesel 6-Cyl. 12.7 L Diesel		38501	SENSOR	- Toma Fuerza, Alt. & A.A.
		38075	POLEA	Tensora - Toma Fuerza, Alt. & A.A.
Caterpillar 3406 Diesel	1999	36091	POLEA	Tensora - Ventilador & Alt.
		36091	POLEA	Tensora - Ventilador a A.A.
		38506	SENSOR	- Ventilador & Alt.
		38508	SENSOR	- Ventilador a A.A.
Caterpillar C10 Diesel	1999	36091	POLEA	guía - Ventilador & Alt.
		38092	POLEA	Tensora - Alt. & A.A.
		36091	POLEA	Tensora - Ventilador & Alt.
		38534	SENSOR	- Ventilador & A.A.
		38506	SENSOR	- Ventilador & Alt.
Caterpillar C12 Diesel	1999	36091	POLEA	Tensora - Ventilador & Alt.
		36091	POLEA	guía - Ventilador & Alt.
		38092	POLEA	Tensora - Alt. & A.A.
		38534	SENSOR	- Ventilador & A.A.
		38506	SENSOR	- Ventilador & Alt.
Cummins ISM Diesel	1999	36091	POLEA	Tensora - A.A.
		38505	SENSOR	- Toma Fuerza & A.A.
		38521	SENSOR	- Ventilador & Alt.
Detroit Diesel 6-Cyl. 11.1 L Diesel	1999	38501	SENSOR	- Toma Fuerza, Alt. & A.A.
		38075	POLEA	Tensora - Toma Fuerza, Alt. & A.A.
Detroit Diesel 6-Cyl. 12.7 L Diesel	1999	38501	SENSOR	- Toma Fuerza, Alt. & A.A.
		38075	POLEA	Tensora - Toma Fuerza, Alt. & A.A.
Caterpillar 3406 Diesel	1998	36091	POLEA	Tensora - Ventilador & Alt.
		36091	POLEA	Tensora - Ventilador a A.A.
		38506	SENSOR	- Ventilador & Alt.
		38508	SENSOR	- Ventilador a A.A.
Caterpillar C10 Diesel	1998	36091	POLEA	Tensora - Ventilador & Alt.
		38506	SENSOR	- Ventilador & Alt.
Caterpillar C12 Diesel	1998	36091	POLEA	Tensora - Ventilador & Alt.
		38505	SENSOR	- Ventilador & Alt.
Cummins ISM Diesel	1998	36091	POLEA	Tensora - A.A.
		38521	SENSOR	- Ventilador & Alt.
		38507	SENSOR	- A.A.

**CLASSIC**

Detroit Diesel 6-Cyl. 14.0 L Diesel	2008	38076	POLEA	Tensora - Ventilador
		38075	POLEA	Tensora - Toma Fuerza, Alt. & A.A.
		38501	SENSOR	- Toma Fuerza, Alt. & A.A.
		38503	SENSOR	- Ventilador
Caterpillar C13 Diesel	2007	36093	POLEA	guía - ranurada
Caterpillar C15 Diesel	2007	36093	POLEA	guía - ranurada
		36091	POLEA	guía - Lisa
Detroit Diesel 6-Cyl. 12.7 L Diesel	2007	38076	POLEA	Tensora - Ventilador
		38501	SENSOR	- Toma Fuerza, Alt. & A.A.
		38075	POLEA	Tensora - Toma Fuerza, Alt. & A.A.
		38503	SENSOR	- Ventilador
Detroit Diesel 6-Cyl. 14.0 L Diesel	2007	38076	POLEA	Tensora - Ventilador
		38503	SENSOR	- Ventilador
		38075	POLEA	Tensora - Toma Fuerza, Alt. & A.A.
		38501	SENSOR	- Toma Fuerza, Alt. & A.A.
Caterpillar C11 Diesel	2006	36093	POLEA	guía - ranurada
Caterpillar C13 Diesel	2006	36093	POLEA	guía - ranurada
Caterpillar C15 Diesel	2006	36091	POLEA	guía - Lisa
		36091	POLEA	Tensora - Ventilador & Alt.
		36093	POLEA	guía - ranurada
		36091	POLEA	Tensora - Ventilador a A.A.
		38506	SENSOR	- Ventilador & Alt.
		38508	SENSOR	- Ventilador a A.A.
Detroit Diesel 6-Cyl. 12.7 L Diesel	2006	38076	POLEA	Tensora - Ventilador
		38503	SENSOR	- Ventilador
		38075	POLEA	Tensora - Toma Fuerza, Alt. & A.A.
		38501	SENSOR	- Toma Fuerza, Alt. & A.A.
Detroit Diesel 6-Cyl. 14.0 L Diesel	2006	38076	POLEA	Tensora - Ventilador
		38503	SENSOR	- Ventilador
		38075	POLEA	Tensora - Toma Fuerza, Alt. & A.A.
		38501	SENSOR	- Toma Fuerza, Alt. & A.A.
Caterpillar C11 Diesel	2005	36093	POLEA	guía - ranurada
Caterpillar C13 Diesel	2005	36093	POLEA	guía - ranurada
Caterpillar C15 Diesel	2005	36091	POLEA	guía - Lisa
		36091	POLEA	Tensora - Ventilador a A.A.
		36093	POLEA	guía - ranurada
		36091	POLEA	Tensora - Ventilador & Alt.
		38506	SENSOR	- Ventilador & Alt.
		38508	SENSOR	- Ventilador a A.A.





Detroit Diesel 6-Cyl. 14.0 L Diesel	2003	38501	SENSOR	- Toma Fuerza, Alt. & A.A.
		38075	POLEA	Tensora - Toma Fuerza, Alt. & A.A.
Caterpillar C10 Diesel	2002	36091	POLEA	guía - Ventilador & Alt.
Caterpillar C12 Diesel	2002	36091	POLEA	guía - Ventilador & Alt.
Caterpillar C15 Diesel	2002	36091	POLEA	Tensora - Ventilador & Alt.
		36091	POLEA	Tensora - Ventilador a A.A.
		38508	SENSOR	- Ventilador a A.A.
		38506	SENSOR	- Ventilador & Alt.
Caterpillar C16 Diesel	2002	36091	POLEA	Tensora - Ventilador a A.A.
		36091	POLEA	Tensora - Ventilador & Alt.
		38508	SENSOR	- Ventilador a A.A.
		38506	SENSOR	- Ventilador & Alt.
Cummins ISM Diesel	2002	36091	POLEA	Tensora - A.A.
		38505	SENSOR	- Toma Fuerza & A.A.
		38521	SENSOR	- Ventilador, Alt. & Toma Fuerza
Detroit Diesel 6-Cyl. 11.1 L Diesel	2002	38501	SENSOR	- Toma Fuerza, Alt. & A.A.
		38075	POLEA	Tensora - Toma Fuerza, Alt. & A.A.
Detroit Diesel 6-Cyl. 12.7 L Diesel	2002	38501	SENSOR	- Toma Fuerza, Alt. & A.A.
		38075	POLEA	Tensora - Toma Fuerza, Alt. & A.A.
Caterpillar C10 Diesel	2001	36091	POLEA	guía - Ventilador & Alt.
Caterpillar C12 Diesel	2001	36091	POLEA	guía - Ventilador & Alt.
Caterpillar C15 Diesel	2001	36091	POLEA	Tensora - Ventilador & Alt.
		36091	POLEA	Tensora - Ventilador a A.A.
		38508	SENSOR	- Ventilador a A.A.
		38506	SENSOR	- Ventilador & Alt.
Caterpillar C16 Diesel	2001	36091	POLEA	Tensora - Ventilador a A.A.
		36091	POLEA	Tensora - Ventilador & Alt.
		38508	SENSOR	- Ventilador a A.A.
		38506	SENSOR	- Ventilador & Alt.
Cummins ISM Diesel	2001	36091	POLEA	Tensora - A.A.
		38505	SENSOR	- Toma Fuerza & A.A.
		38521	SENSOR	- Ventilador & Alt.
Detroit Diesel 6-Cyl. 11.1 L Diesel	2001	38501	SENSOR	- Toma Fuerza, Alt. & A.A.
		38075	POLEA	Tensora - Toma Fuerza, Alt. & A.A.
Detroit Diesel 6-Cyl. 12.7 L Diesel	2001	38075	POLEA	Tensora - Toma Fuerza, Alt. & A.A.
		38501	SENSOR	- Toma Fuerza, Alt. & A.A.
Detroit Diesel 6-Cyl. 14.0 L Diesel	2001	38075	POLEA	Tensora - Toma Fuerza, Alt. & A.A.
		38501	SENSOR	- Toma Fuerza, Alt. & A.A.

Detroit Diesel 6-Cyl. 12.7 L Diesel		38076	POLEA	Tensora - Ventilador
		38075	POLEA	Tensora - Toma Fuerza, Alt. & A.A.
		38501	SENSOR	- Toma Fuerza, Alt. & A.A.
		38503	SENSOR	- Ventilador
Detroit Diesel 6-Cyl. 14.0 L Diesel	2006	38076	POLEA	Tensora - Ventilador
		38501	SENSOR	- Toma Fuerza, Alt. & A.A.
		38075	POLEA	Tensora - Toma Fuerza, Alt. & A.A.
		38503	SENSOR	- Ventilador
DETROIT DIESEL SERIE 60	2006	38076	POLEA	Vent.
		38501	SENSOR	Toma de Fuerza, Alt. y A.A.
		38503	SENSOR	Vent.
		38075	POLEA	Toma de Fuerza, Alt y A.A.
Mercedes-Benz MBE 4000 Diesel	2006	38597	SENSOR	- Ventilador
		38501	SENSOR	- Toma Fuerza, Alt. & A.A.
		38075	POLEA	Tensora - Toma Fuerza, Alt. & A.A.
Caterpillar C11 Diesel	2005	36093	POLEA	guía - ranurada
Caterpillar C13 Diesel	2005	38590	SENSOR	- Ventilador, Alt. & A.A.
		36093	POLEA	guía - ranurada
Caterpillar C15 Diesel	2005	38569	SENSOR	- Ventilador & Alt.
		36091	POLEA	Tensora - Ventilador a A.A.
		36091	POLEA	guía - Lisa
		36093	POLEA	guía - ranurada
		38511	SENSOR	- Ventilador a A.A.
		38511	SENSOR	Vent. al A.A.
Detroit Diesel 6-Cyl. 12.7 L Diesel	2005	38076	POLEA	Tensora - Ventilador
		38075	POLEA	Tensora - Toma Fuerza, Alt. & A.A.
		38501	SENSOR	- Toma Fuerza, Alt. & A.A.
		38503	SENSOR	- Ventilador
Detroit Diesel 6-Cyl. 14.0 L Diesel	2005	38076	POLEA	Tensora - Ventilador
		38075	POLEA	Tensora - Toma Fuerza, Alt. & A.A.
		38503	SENSOR	- Ventilador
		38501	SENSOR	- Toma Fuerza, Alt. & A.A.
DETROIT DIESEL SERIE 60	2005	38076	POLEA	Vent.
		38075	POLEA	Toma de Fuerza, Alt. y A.A.
		38501	SENSOR	Alt., Toma de Fuerza, C/AA
		38503	SENSOR	Vent.
Mercedes-Benz MBE 4000 Diesel	2005	38597	SENSOR	- Ventilador
		38501	SENSOR	- Toma Fuerza, Alt. & A.A.
		38075	POLEA	Toma de Fuerza, Alt. y A.A.
		38075	POLEA	Tensora - Toma Fuerza, Alt. & A.A.
Caterpillar C11 Diesel	2004	38590	SENSOR	- Ventilador, Alt. & A.A.
		36093	POLEA	guía - ranurada
Caterpillar C12 Diesel	2004	36091	POLEA	guía - Ventilador & Alt.
		36091	POLEA	Tensora - Ventilador, Alt. & Toma Fuerza
		36091	POLEA	Tensora - Ventilador a A.A.
		38506	SENSOR	- Ventilador, Alt. & Toma Fuerza
		38524	SENSOR	- Ventilador a A.A.
Caterpillar C13 Diesel	2004	38590	SENSOR	- Ventilador, Alt. & A.A.
		36093	POLEA	guía - ranurada
Caterpillar C15 Diesel	2004	36091	POLEA	guía - Lisa
		36093	POLEA	guía - ranurada
Caterpillar C16 Diesel	2004	36091	POLEA	Tensora - Ventilador & Alt.
		36091	POLEA	Tensora - Ventilador a A.A.
		38508	SENSOR	- Ventilador a A.A.
		38506	SENSOR	- Ventilador & Alt.
Detroit Diesel 6-Cyl. 12.7 L Diesel	2004	38076	POLEA	Tensora - Ventilador
		38501	SENSOR	- Toma Fuerza, Alt. & A.A.
		38075	POLEA	Tensora - Toma Fuerza, Alt. & A.A.
		38503	SENSOR	- Ventilador
Detroit Diesel 6-Cyl. 14.0 L Diesel	2004	38076	POLEA	Tensora - Ventilador
		38075	POLEA	Tensora - Toma Fuerza, Alt. & A.A.
		38501	SENSOR	- Toma Fuerza, Alt. & A.A.
		38503	SENSOR	- Ventilador
DETROIT DIESEL SERIE 60	2004	38501	SENSOR	Alt., Toma de Fuerza, C/AA
		38503	SENSOR	Vent.
Mercedes-Benz MBE 4000 Diesel	2004	38540	SENSOR	- A.A.
		38541	SENSOR	- Toma Fuerza & Alt.
Caterpillar C10 Diesel	2003	36091	POLEA	guía - Ventilador & Alt.
		36091	POLEA	Tensora - Ventilador, Alt. & Toma Fuerza
		36091	POLEA	Tensora - Ventilador a A.A.
		38506	SENSOR	- Ventilador, Alt. & Toma Fuerza
		38524	SENSOR	- Ventilador a A.A.
Caterpillar C12 Diesel	2003	36091	POLEA	guía - Ventilador & Alt.
		36091	POLEA	Tensora - Ventilador, Alt. & Toma Fuerza
		36091	POLEA	Tensora - Ventilador a A.A.

**COLUMBIA**

Caterpillar C13 Diesel	2008	38590	SENSOR	- Ventilador, Alt. & A.A.
		36093	POLEA	guía - ranurada
Caterpillar C15 Diesel	2008	36091	POLEA	guía - Lisa
		36093	POLEA	guía - ranurada
Detroit Diesel 6-Cyl. 12.7 L Diesel	2008	38076	POLEA	Tensora - Ventilador
		38503	SENSOR	- Ventilador
		38075	POLEA	Tensora - Toma Fuerza, Alt. & A.A.
		38501	SENSOR	- Toma Fuerza, Alt. & A.A.
Detroit Diesel 6-Cyl. 14.0 L Diesel	2008	38076	POLEA	Tensora - Ventilador
		38075	POLEA	Tensora - Toma Fuerza, Alt. & A.A.
		38501	SENSOR	- Toma Fuerza, Alt. & A.A.
		38503	SENSOR	- Ventilador
Caterpillar C11 Diesel	2007	38590	SENSOR	- Ventilador, Alt. & A.A.
		36093	POLEA	guía - ranurada
Caterpillar C13 Diesel	2007	38590	SENSOR	- Ventilador, Alt. & A.A.
		36093	POLEA	guía - ranurada
Caterpillar C15 Diesel	2007	36093	POLEA	guía - ranurada
		36091	POLEA	guía - Lisa
Detroit Diesel 6-Cyl. 12.7 L Diesel	2007	38076	POLEA	Tensora - Ventilador
		38075	POLEA	Tensora - Toma Fuerza, Alt. & A.A.
		38501	SENSOR	- Toma Fuerza, Alt. & A.A.
		38503	SENSOR	- Ventilador
Detroit Diesel 6-Cyl. 14.0 L Diesel	2007	38076	POLEA	Tensora - Ventilador
		38501	SENSOR	- Toma Fuerza, Alt. & A.A.
		38075	POLEA	Tensora - Toma Fuerza, Alt. & A.A.
		38503	SENSOR	- Ventilador
Mercedes-Benz MBE 4000 Diesel	2007	38597	SENSOR	- Ventilador
		38501	SENSOR	- Toma Fuerza, Alt. & A.A.
		38075	POLEA	Tensora - Toma Fuerza, Alt. & A.A.
Caterpillar C11 Diesel	2006	38590	SENSOR	- Ventilador, Alt. & A.A.
		36093	POLEA	guía - ranurada
Caterpillar C13 Diesel	2006	38590	SENSOR	- Ventilador, Alt. & A.A.
		36093	POLEA	guía - ranurada
Caterpillar C15 Diesel	2006	36091	POLEA	guía - Lisa
		36093	POLEA	guía - ranurada



Caterpillar C12 Diesel	2003	38524	SENSOR	- Ventilador a A.A.
		38506	SENSOR	- Ventilador, Alt. & Toma Fuerza
Caterpillar C15 Diesel	2003	36091	POLEA	Tensora - Ventilador & Alt.
		36091	POLEA	Tensora - Ventilador a A.A.
		38508	SENSOR	- Ventilador a A.A.
		38506	SENSOR	- Ventilador & Alt.
Caterpillar C16 Diesel	2003	36091	POLEA	Tensora - Ventilador a A.A.
		36091	POLEA	Tensora - Ventilador & Alt.
		38506	SENSOR	- Ventilador & Alt.
		38508	SENSOR	- Ventilador a A.A.
Cummins ISM Diesel	2003	36091	POLEA	Tensora - A.A.
		38521	SENSOR	- Ventilador & Alt.
		38505	SENSOR	- Toma Fuerza & A.A.
Detroit Diesel 6-Cyl. 12.7 L Diesel	2003	38501	SENSOR	- Toma Fuerza, Alt. & A.A.
		38075	POLEA	Tensora - Toma Fuerza, Alt. & A.A.
Detroit Diesel 6-Cyl. 14.0 L Diesel	2003	38075	POLEA	Tensora - Toma Fuerza, Alt. & A.A.
		38501	SENSOR	- Toma Fuerza, Alt. & A.A.
DETROIT DIESEL SERIE 60	2003	38501	SENSOR	A.A.; Vent.
Mercedes-Benz MBE 4000 Diesel	2003	38540	SENSOR	- A.A.
		38541	SENSOR	- Toma Fuerza & Alt.
Caterpillar C10 Diesel	2002	36091	POLEA	guía - Ventilador & Alt.
		36091	POLEA	Tensora - Ventilador, Alt. & Toma Fuerza
		36091	POLEA	Tensora - Ventilador a A.A.
		38524	SENSOR	- Ventilador a A.A.
		38506	SENSOR	- Ventilador, Alt. & Toma Fuerza
Caterpillar C12 Diesel	2002	36091	POLEA	guía - Ventilador & Alt.
Caterpillar C15 Diesel	2002	36091	POLEA	Tensora - Ventilador & Alt.
		36091	POLEA	Tensora - Ventilador a A.A.
		38506	SENSOR	- Ventilador & Alt.
Caterpillar C16 Diesel	2002	38508	SENSOR	- Ventilador a A.A.
		36091	POLEA	Tensora - Ventilador a A.A.
		36091	POLEA	Tensora - Ventilador & Alt.
Cummins ISM Diesel	2002	38506	SENSOR	- Ventilador & Alt.
		36091	POLEA	Tensora - A.A.
		38521	SENSOR	- Ventilador & Alt.
		38505	SENSOR	- Toma Fuerza & A.A.
Detroit Diesel 6-Cyl. 12.7 L Diesel	2002	38075	POLEA	Tensora - Toma Fuerza, Alt. & A.A.
		38501	SENSOR	- Toma Fuerza, Alt. & A.A.
Detroit Diesel 6-Cyl. 14.0 L Diesel	2002	38501	SENSOR	- Toma Fuerza, Alt. & A.A.
		38075	POLEA	Tensora - Toma Fuerza, Alt. & A.A.
Caterpillar C10 Diesel	2001	36091	POLEA	guía - Ventilador & Alt.
		36091	POLEA	Tensora - Ventilador, Alt. & Toma Fuerza
		36091	POLEA	Tensora - Ventilador a A.A.
		38524	SENSOR	- Ventilador a A.A.
		38506	SENSOR	- Ventilador, Alt. & Toma Fuerza
Caterpillar C12 Diesel	2001	36091	POLEA	guía - Ventilador & Alt.
Caterpillar C15 Diesel	2001	36091	POLEA	Tensora - Ventilador a A.A.
		36091	POLEA	Tensora - Ventilador & Alt.
		38506	SENSOR	- Ventilador & Alt.
Caterpillar C16 Diesel	2001	38508	SENSOR	- Ventilador a A.A.
		36091	POLEA	Tensora - Ventilador a A.A.
		36091	POLEA	Tensora - Ventilador & Alt.
Cummins ISM Diesel	2001	38506	SENSOR	- Ventilador & Alt.
		36091	POLEA	Tensora - A.A.
		38521	SENSOR	- Ventilador & Alt.
Cummins ISX Diesel	2001	38505	SENSOR	- Toma Fuerza & A.A.
		36092	POLEA	Tensora - Ventilador & Toma Fuerza
		38535	SENSOR	- Ventilador & Toma Fuerza
		36095	POLEA	Tensora - Toma Fuerza, Alt. & A.A.
		38532	SENSOR	- Toma Fuerza, Alt. & A.A.
Detroit Diesel 6-Cyl. 11.1 L Diesel	2001	38501	SENSOR	- Toma Fuerza, Alt. & A.A.
		38075	POLEA	Tensora - Toma Fuerza, Alt. & A.A.
Detroit Diesel 6-Cyl. 12.7 L Diesel	2001	38075	POLEA	Tensora - Toma Fuerza, Alt. & A.A.
		38501	SENSOR	- Toma Fuerza, Alt. & A.A.
DETROIT DIESEL SERIE 60	2001	38075	POLEA	Loca
		38501	SENSOR	
Detroit Diesel 6-Cyl. 11.1 L Diesel	2000	38501	SENSOR	- Toma Fuerza, Alt. & A.A.
		38075	POLEA	Tensora - Toma Fuerza, Alt. & A.A.
Detroit Diesel 6-Cyl. 12.7 L Diesel	2000	38075	POLEA	Tensora - Toma Fuerza, Alt. & A.A.
		38501	SENSOR	- Toma Fuerza, Alt. & A.A.

Caterpillar C13 Diesel	2005	36093	POLEA	guía - ranurada
		38590	SENSOR	- Toma Fuerza, Ventilador, Alt. & A.A.
		36093	POLEA	guía - ranurada
Caterpillar C7 Diesel	2005	36091	POLEA	guía - Lisa
Caterpillar C10 Diesel	2004	36091	POLEA	Tensora - Ventilador, Alt. & Toma Fuerza
		36091	POLEA	Tensora - Ventilador a A.A.
		36091	POLEA	guía - Ventilador & Alt.
		38524	SENSOR	- Ventilador a A.A.
		38506	SENSOR	- Ventilador, Alt. & Toma Fuerza
Caterpillar C11 Diesel	2004	36093	POLEA	guía - ranurada
Caterpillar C12 Diesel	2004	36091	POLEA	Tensora - Ventilador a A.A.
		36091	POLEA	Tensora - Ventilador, Alt. & Toma Fuerza
		36091	POLEA	guía - Ventilador & Alt.
		38524	SENSOR	- Ventilador a A.A.
		38506	SENSOR	- Ventilador, Alt. & Toma Fuerza
Caterpillar C13 Diesel	2004	36093	POLEA	guía - ranurada
Caterpillar C10 Diesel	2003	36091	POLEA	guía - Ventilador & Alt.
		36091	POLEA	Tensora - Ventilador a A.A.
		36091	POLEA	Tensora - Ventilador, Alt. & Toma Fuerza
		38506	SENSOR	- Ventilador, Alt. & Toma Fuerza
Caterpillar C12 Diesel	2003	36091	POLEA	guía - Ventilador & Alt.
		36091	POLEA	Tensora - Ventilador a A.A.
		36091	POLEA	Tensora - Ventilador, Alt. & Toma Fuerza
		38524	SENSOR	- Ventilador a A.A.
		36091	POLEA	guía - Ventilador & Alt.
		36091	POLEA	Tensora - Ventilador a A.A.
Caterpillar C10 Diesel	2002	36091	POLEA	Tensora - Ventilador, Alt. & Toma Fuerza
		36091	POLEA	Tensora - Ventilador a A.A.
		38506	SENSOR	- Ventilador a A.A.
Caterpillar C12 Diesel	2002	36091	POLEA	guía - Ventilador & Alt.
		36091	POLEA	Tensora - Ventilador a A.A.
		36091	POLEA	Tensora - Ventilador, Alt. & Toma Fuerza
		38506	SENSOR	- Ventilador, Alt. & Toma Fuerza
Cummins ISM Diesel	2002	36091	POLEA	Tensora - A.A.
		38521	SENSOR	- Ventilador & Alt.
		38505	SENSOR	- Toma Fuerza & A.A.
Detroit Diesel 6-Cyl. 12.7 L Diesel	2002	38075	POLEA	Tensora - Toma Fuerza, Alt. & A.A.
		38501	SENSOR	- Toma Fuerza, Alt. & A.A.
Detroit Diesel 6-Cyl. 14.0 L Diesel	2002	38501	SENSOR	- Toma Fuerza, Alt. & A.A.
		38075	POLEA	Tensora - Toma Fuerza, Alt. & A.A.
Caterpillar C10 Diesel	2001	36091	POLEA	guía - Ventilador & Alt.
		36091	POLEA	Tensora - Ventilador, Alt. & Toma Fuerza
		36091	POLEA	Tensora - Ventilador a A.A.
		38524	SENSOR	- Ventilador a A.A.
		38506	SENSOR	- Ventilador, Alt. & Toma Fuerza
Caterpillar C12 Diesel	2001	36091	POLEA	guía - Ventilador & Alt.
Caterpillar C15 Diesel	2001	36091	POLEA	Tensora - Ventilador a A.A.
		36091	POLEA	Tensora - Ventilador, Alt. & Toma Fuerza
		38506	SENSOR	- Ventilador, Alt. & Toma Fuerza
		38524	SENSOR	- Ventilador a A.A.
Cummins ISM Diesel	2001	36091	POLEA	Tensora - A.A.
		38505	SENSOR	- Ventilador & Alt.
		38505	SENSOR	- Toma Fuerza & A.A.
Caterpillar C10 Diesel	2001	36091	POLEA	Tensora - Ventilador a A.A.
		36091	POLEA	Tensora - Ventilador, Alt. & Toma Fuerza
		38506	SENSOR	- Ventilador, Alt. & Toma Fuerza
		38524	SENSOR	- Ventilador a A.A.
Caterpillar C12 Diesel	2001	36091	POLEA	guía - Ventilador & Alt.
		36091	POLEA	Tensora - Ventilador a A.A.
		38506	SENSOR	- Ventilador, Alt. & Toma Fuerza
		38524	SENSOR	- Ventilador a A.A.
Cummins ISM Diesel	2001	36091	POLEA	Tensora - A.A.
		38505	SENSOR	- Toma Fuerza & A.A.
		38521	SENSOR	- Ventilador & Alt.

**CORONADO**

Detroit Diesel 6-Cyl. 12.7 L Diesel	2008	38076	POLEA	Tensora - Ventilador
		38075	POLEA	Tensora - Toma Fuerza, Alt. & A.A.
		38501	SENSOR	- Toma Fuerza, Alt. & A.A.
		38503	SENSOR	- Ventilador
Detroit Diesel 6-Cyl. 14.0 L Diesel	2008	38076	POLEA	Tensora - Ventilador
		38075	POLEA	Tensora - Toma Fuerza, Alt. & A.A.
		38503	SENSOR	- Ventilador
		38501	SENSOR	- Toma Fuerza, Alt. & A.A.
Caterpillar C15 Diesel	2007	36091	POLEA	guía - Lisa
		36093	POLEA	guía - ranurada
Detroit Diesel 6-Cyl. 12.7 L Diesel	2007	38076	POLEA	Tensora - Ventilador
		38503	SENSOR	- Ventilador
		38075	POLEA	Tensora - Toma Fuerza, Alt. & A.A.
		38501	SENSOR	- Toma Fuerza, Alt. & A.A.
Detroit Diesel 6-Cyl. 14.0 L Diesel	2007	38076	POLEA	Tensora - Ventilador
		38075	POLEA	Tensora - Toma Fuerza, Alt. & A.A.
		38501	SENSOR	- Toma Fuerza, Alt. & A.A.
		38503	SENSOR	- Ventilador
Caterpillar C15 Diesel	2006	38569	SENSOR	- Ventilador & Alt.
		36093	POLEA	guía - ranurada
		38511	SENSOR	- Ventilador a A.A.

**CONDOR**

Caterpillar C11 Diesel	2005	38590	SENSOR	- Toma Fuerza, Ventilador, Alt. & A.A.
------------------------	------	-------	--------	--



Caterpillar C15 Diesel	2006	36091	POLEA	guía - Lisa
		36091	POLEA	Tensora - Ventilador a A.A.
Detroit Diesel 6-Cyl. 12.7 L Diesel	2006	38076	POLEA	Tensora - Ventilador
		38503	SENSOR	- Ventilador
		38501	SENSOR	- Toma Fuerza, Alt. & A.A.
		38075	POLEA	Tensora - Toma Fuerza, Alt. & A.A.
Detroit Diesel 6-Cyl. 14.0 L Diesel	2006	38076	POLEA	Tensora - Ventilador
		38501	SENSOR	- Toma Fuerza, Alt. & A.A.
		38075	POLEA	Tensora - Toma Fuerza, Alt. & A.A.
		38503	SENSOR	- Ventilador
DETROIT DIESEL SERIE 60	2006	38076	POLEA	Vent.
		38501	SENSOR	Toma de Fuerza, Alt. y A.A.
		38503	SENSOR	Vent.
		38075	POLEA	Toma de Fuerza, Alt y A.A.
Caterpillar C15 Diesel	2005	38569	SENSOR	- Ventilador & Alt.
		36093	POLEA	guía - ranurada
		38511	SENSOR	- Ventilador a A.A.
		36091	POLEA	guía - Lisa
Detroit Diesel 6-Cyl. 12.7 L Diesel	2005	38076	POLEA	Tensora - Ventilador a A.A.
		38501	SENSOR	Tensora - Ventilador
		38503	SENSOR	- Toma Fuerza, Alt. & A.A.
		38075	POLEA	- Ventilador
Detroit Diesel 6-Cyl. 14.0 L Diesel	2005	38076	POLEA	Tensora - Toma Fuerza, Alt. & A.A.
		38075	POLEA	Tensora - Ventilador
		38075	POLEA	Tensora - Toma Fuerza, Alt. & A.A.
		38503	SENSOR	- Ventilador
DETROIT DIESEL SERIE 60	2005	38501	SENSOR	- Toma Fuerza, Alt. & A.A.
		38076	POLEA	Tensora, Vent.
		38503	SENSOR	Vent
		38075	POLEA	Tensora, Toma de Fuerza, Alt., A.A.
		38501	SENSOR	Toma de Fuerza, Alt., A.A.
Caterpillar C15 Diesel	2004	36093	POLEA	guía - ranurada
		36091	POLEA	guía - Lisa
		36091	POLEA	Tensora - Ventilador a A.A.
		36091	POLEA	Tensora - Ventilador & Alt.
		38508	SENSOR	- Ventilador a A.A.
		38506	SENSOR	- Ventilador & Alt.
Detroit Diesel 6-Cyl. 12.7 L Diesel	2004	38076	POLEA	Tensora - Ventilador
		38503	SENSOR	- Ventilador
		38075	POLEA	Tensora - Toma Fuerza, Alt. & A.A.
		38501	SENSOR	- Toma Fuerza, Alt. & A.A.
Detroit Diesel 6-Cyl. 14.0 L Diesel	2004	38076	POLEA	Tensora - Ventilador
		38503	SENSOR	- Ventilador
		38501	SENSOR	- Toma Fuerza, Alt. & A.A.
		38075	POLEA	Tensora - Toma Fuerza, Alt. & A.A.
DETROIT DIESEL SERIE 60	2004	38503	SENSOR	Vent.
		38075	POLEA	Toma de Fuerza, Alt. y A.A.
		38501	SENSOR	Alt., Toma de Fuerza, C/AA
Caterpillar C15 Diesel	2003	36091	POLEA	Tensora - Ventilador & Alt.
		36091	POLEA	Tensora - Ventilador a A.A.
		38506	SENSOR	- Ventilador & Alt.
		38508	SENSOR	- Ventilador a A.A.
Caterpillar C16 Diesel	2003	36091	POLEA	Tensora - Ventilador & Alt.
		36091	POLEA	Tensora - Ventilador a A.A.
		38508	SENSOR	- Ventilador a A.A.
		38506	SENSOR	- Ventilador & Alt.
Detroit Diesel 6-Cyl. 12.7 L Diesel	2003	38506	SENSOR	- Ventilador & Alt.
		38076	POLEA	Tensora - Ventilador
		38501	SENSOR	- Toma Fuerza, Alt. & A.A.
		38075	POLEA	Tensora - Toma Fuerza, Alt. & A.A.
		38503	SENSOR	- Ventilador
Detroit Diesel 6-Cyl. 14.0 L Diesel	2003	38076	POLEA	Tensora - Ventilador
		38503	SENSOR	- Ventilador
		38501	SENSOR	- Toma Fuerza, Alt. & A.A.
		38075	POLEA	Tensora - Toma Fuerza, Alt. & A.A.
Caterpillar C15 Diesel	2002	36091	POLEA	Tensora - Ventilador & Alt.
		36091	POLEA	Tensora - Ventilador a A.A.
		38508	SENSOR	- Ventilador a A.A.
		38506	SENSOR	- Ventilador & Alt.
Caterpillar C16 Diesel	2002	36091	POLEA	Tensora - Ventilador a A.A.
		36091	POLEA	Tensora - Ventilador & Alt.
		38508	SENSOR	- Ventilador a A.A.
		38506	SENSOR	- Ventilador & Alt.
Detroit Diesel 6-Cyl. 12.7 L Diesel	2002	38076	POLEA	Tensora - Ventilador
		38503	SENSOR	- Ventilador
		38075	POLEA	Tensora - Toma Fuerza, Alt. & A.A.



		38501	SENSOR	- Toma Fuerza, Alt. & A.A.
<b>FC70</b>				
Cummins ISB Diesel	2003	38517	SENSOR	
		36095	POLEA	Tensora
<b>FC80</b>				
Cummins ISB Diesel	2003	38517	SENSOR	
		36095	POLEA	Tensora
<b>FL112</b>				
Caterpillar C10 Diesel	2004	36091	POLEA	Tensora - Ventilador a A.A.
		36091	POLEA	guía - Ventilador & Alt.
		36091	POLEA	Tensora - Ventilador, Alt. & Toma Fuerza
		38506	SENSOR	- Ventilador, Alt. & Toma Fuerza
		38524	SENSOR	- Ventilador a A.A.
Caterpillar C12 Diesel	2004	36091	POLEA	Tensora - Ventilador, Alt. & Toma Fuerza
		36091	POLEA	Tensora - Ventilador a A.A.
		38506	SENSOR	guía - Ventilador & Alt.
		38524	SENSOR	- Ventilador, Alt. & Toma Fuerza
Mercedes-Benz MBE 4000 Diesel	2004	38541	SENSOR	- Ventilador a A.A.
		38540	SENSOR	- A.A.
Caterpillar C10 Diesel	2003	36091	POLEA	Tensora - Ventilador, Alt. & Toma Fuerza
		36091	POLEA	Tensora - Ventilador a A.A.
		36091	POLEA	guía - Ventilador & Alt.
		38524	SENSOR	- Ventilador a A.A.
		38506	SENSOR	- Ventilador, Alt. & Toma Fuerza
Caterpillar C12 Diesel	2003	36091	POLEA	Tensora - Ventilador a A.A.
		36091	POLEA	Tensora - Ventilador, Alt. & Toma Fuerza
		36091	POLEA	guía - Ventilador & Alt.
		38524	SENSOR	- Ventilador a A.A.
Cummins ISM Diesel	2003	36091	POLEA	Tensora - A.A.
		38521	SENSOR	- Ventilador & Alt.
		38505	SENSOR	- Toma Fuerza & A.A.
		38505	SENSOR	Toma de Fuerza, A.A.
Mercedes-Benz MBE 4000 Diesel	2003	38540	SENSOR	- A.A.
		38541	SENSOR	- Toma Fuerza & Alt.
Caterpillar C10 Diesel	2002	36091	POLEA	guía - Ventilador & Alt.
		36091	POLEA	Tensora - Ventilador, Alt. & Toma Fuerza
		36091	POLEA	Tensora - Ventilador a A.A.
		38524	SENSOR	- Ventilador a A.A.
		38506	SENSOR	- Ventilador, Alt. & Toma Fuerza
Caterpillar C12 Diesel	2002	36091	POLEA	guía - Ventilador & Alt.
		36091	POLEA	Tensora - Ventilador, Alt. & Toma Fuerza
		36091	POLEA	Tensora - Ventilador a A.A.
		38524	SENSOR	- Ventilador a A.A.
Cummins ISM Diesel	2002	36091	POLEA	Tensora - A.A.
		38521	SENSOR	- Ventilador & Alt.
		38505	SENSOR	Toma de Fuerza, A.A.
		38505	SENSOR	- Toma Fuerza & A.A.
Caterpillar C10 Diesel	2001	36091	POLEA	Tensora - Ventilador a A.A.
		36091	POLEA	Tensora - Ventilador, Alt. & Toma Fuerza
		36091	POLEA	guía - Ventilador & Alt.
		38506	SENSOR	- Ventilador, Alt. & Toma Fuerza
		38524	SENSOR	- Ventilador a A.A.
Caterpillar C12 Diesel	2001	36091	POLEA	Tensora - Ventilador a A.A.
		36091	POLEA	Tensora - Ventilador, Alt. & Toma Fuerza
		36091	POLEA	guía - Ventilador & Alt.
		38524	SENSOR	- Ventilador a A.A.
Cummins ISM Diesel	2001	36091	POLEA	Tensora - A.A.
		38521	SENSOR	- Ventilador & Alt.
		38505	SENSOR	- Toma Fuerza & A.A.
Caterpillar C10 Diesel	2000	38092	POLEA	Tensora - Alt. & A.A.
		36091	POLEA	guía - Ventilador & Alt.
		36091	POLEA	Tensora - Ventilador, Alt. & Toma Fuerza
		38506	SENSOR	- Ventilador, Alt. & Toma Fuerza
		38534	SENSOR	- Ventilador & A.A.
Caterpillar C12 Diesel	2000	36091	POLEA	Tensora - Ventilador, Alt. & Toma Fuerza
		38092	POLEA	Tensora - Alt. & A.A.



Caterpillar C12 Diesel	2000	36091 38506 38534	POLEA TENSOR TENSOR	guía - Ventilador & Alt. - Ventilador, Alt. & Toma Fuerza - Ventilador & A.A.	
Cummins ISM Diesel	2000	36091 38521 38505	POLEA TENSOR TENSOR	Tensora - A.A. - Ventilador & Alt. - Toma Fuerza & A.A.	
Caterpillar C10 Diesel	1999	36091 36091 38092 38534 38506	POLEA POLEA POLEA TENSOR TENSOR	guía - Ventilador & Alt. Tensora - Ventilador & Alt. Tensora - Alt. & A.A. - Ventilador & A.A. - Ventilador & Alt.	
Caterpillar C12 Diesel	1999	38092 36091 36091 38534 38506	POLEA POLEA POLEA TENSOR TENSOR	Tensora - Alt. & A.A. Tensora - Ventilador & Alt. guía - Ventilador & Alt. - Ventilador & A.A.	
Cummins ISM Diesel	1999	36091 38505	POLEA TENSOR	- Ventilador & Alt. - Toma Fuerza & A.A.	
DETROIT DIESEL SERIE 50	1999	38505	TENSOR	QR 6X4	

Caterpillar 3126 Diesel	1995	36096 38511 36096 38511 36091	POLEA TENSOR POLEA TENSOR POLEA	guía - Ventilador, Alt. & A.A. guía - Ventilador, Alt. & A.A. Tensora - Ventilador, Alt. & A.A.	

**FL50**

Cummins ISC Diesel	2005	36093 38516	POLEA TENSOR	Tensora - Ventilador, Alt. & Toma Fuerza - Ventilador, Alt. & Toma Fuerza
Caterpillar 3126 Diesel	2004	36091 38511 36096	POLEA TENSOR POLEA	Tensora - Ventilador, Alt. & A.A. - Ventilador, Alt. & A.A. guía - Alt. & A.A.
Caterpillar C7 Diesel	2004	36091 38508	POLEA TENSOR	guía - Lisa - Ventilador & Alt.
Cummins ISC Diesel	2004	36093 38516	POLEA TENSOR	Tensora - Ventilador, Alt. & Toma Fuerza - Ventilador, Alt. & Toma Fuerza
Caterpillar 3126 Diesel	2003	36091 36096	POLEA POLEA	Tensora - Ventilador, Alt. & A.A. guía - Alt. & A.A.
Cummins ISB Diesel	2003	38511 36093	TENSOR POLEA	- Ventilador, Alt. & A.A. Tensora - Ventilador, Alt. & Toma Fuerza
Cummins ISC Diesel	2003	38516 36093	TENSOR POLEA	- Ventilador, Alt. & Toma Fuerza Tensora - Ventilador, Alt. & Toma Fuerza
Caterpillar 3126 Diesel	2002	36091 36096 36091 38511	POLEA POLEA POLEA TENSOR	Tensora - Ventilador, Alt. & Toma Fuerza guía Tensora - Ventilador, Alt. & A.A. - Ventilador, Alt. & A.A.
Cummins ISB Diesel	2002	36093 38516	POLEA TENSOR	Tensora - Ventilador, Alt. & Toma Fuerza - Ventilador, Alt. & Toma Fuerza
Cummins ISC Diesel	2002	36093 38516	POLEA TENSOR	Tensora - Ventilador, Alt. & Toma Fuerza - Ventilador, Alt. & Toma Fuerza
Caterpillar 3126 Diesel	2001	38511 36096 36091	TENSOR POLEA POLEA	- Ventilador, Alt. & A.A. guía Tensora - Ventilador, Alt. & A.A.
Cummins ISB Diesel	2001	36093 38516	POLEA TENSOR	Tensora - Ventilador, Alt. - Ventilador & Alt.
Cummins ISC Diesel	2001	38525 36096	TENSOR POLEA	- Ventilador, Alt. & Toma Fuerza guía
Caterpillar 3126 Diesel	2000	36091 36096 36091 38511	POLEA POLEA POLEA TENSOR	Tensora - Ventilador, Alt. & A.A. Tensora - Ventilador, Alt. & A.A. - Ventilador, Alt. & A.A.
Cummins ISB Diesel	2000	36093 38516	POLEA TENSOR	Tensora - Ventilador, Alt. & Toma Fuerza - Ventilador, Alt. & A.A.
Cummins ISC Diesel	2000	38525 36096	TENSOR POLEA	- Ventilador, Alt. & Toma Fuerza guía
Caterpillar 3126 Diesel	1999	36091 36096 38511	POLEA POLEA TENSOR	Tensora - Ventilador, Alt. & A.A. guía - Ventilador, Alt. & A.A.
Cummins ISB Diesel	1999	36093 38516	POLEA TENSOR	Tensora - Ventilador, Alt. & A.A. - Ventilador, B.A. & Alt.
Cummins ISC Diesel	1999	36093 38516	POLEA TENSOR	Tensora - Ventilador, Alt. & Toma Fuerza - Ventilador, Alt. & Toma Fuerza
Caterpillar 3126 Diesel	1998	36096 38511	POLEA TENSOR	guía - Ventilador, Alt. & A.A.
Cummins ISB Diesel	1998	36093 38516	POLEA TENSOR	Tensora - Ventilador, B.A. & Alt. - Ventilador, B.A. & Alt.
Cummins ISC Diesel	1998	36091 38513	POLEA TENSOR	Tensora - Ventilador, Alt. & A.A.
Caterpillar 3126 Diesel	1997	38511 36096 36091	TENSOR POLEA POLEA	- Ventilador, Alt. & A.A. guía Tensora - Ventilador, Alt. & A.A.
Cummins B Series 5.9 L Diesel	1997	36093 38516	POLEA TENSOR	Tensora - Ventilador, B.A. & Alt. - Ventilador, B.A. & Alt.
Caterpillar 3126 Diesel	1996	36091	POLEA	Tensora - Ventilador, Alt. & A.A.

**FL60**

Caterpillar C7 Diesel	2005	36091 36091 38511	POLEA POLEA TENSOR	guía - Lisa Tensora - Ventilador, Alt. & A.A. - Ventilador, Alt. & A.A.
Caterpillar 3126 Diesel	2004	38508 38511 36096	TENSOR TENSOR POLEA	- Ventilador & Alt. - Ventilador, Alt. & A.A. guía
Caterpillar C7 Diesel	2004	36091 38511 36091	POLEA TENSOR POLEA	Tensora - Ventilador, Alt. & A.A. guía - Lisa - Ventilador, Alt. & A.A.
Cummins ISC Diesel	2004	36093 38516	POLEA TENSOR	Tensora - Ventilador, Alt. & Toma Fuerza - Ventilador, Alt. & Toma Fuerza
Caterpillar 3126 Diesel	2003	36096 36091 38511	POLEA POLEA TENSOR	guía Tensora - Ventilador, Alt. & A.A. - Ventilador, Alt. & A.A.
Cummins ISB Diesel	2003	36093 38516	POLEA TENSOR	Tensora - Ventilador, Alt. & Toma Fuerza - Ventilador, Alt. & Toma Fuerza
Cummins ISC Diesel	2003	36093 38516	POLEA TENSOR	Tensora - Ventilador, Alt. & Toma Fuerza - Ventilador, Alt. & Toma Fuerza
Caterpillar 3126 Diesel	2002	36091 36096 38511	POLEA POLEA TENSOR	Tensora - Ventilador, Alt. & A.A. guía - Ventilador, Alt. & A.A.
Cummins ISB Diesel	2002	36093 38516	POLEA TENSOR	Tensora - Ventilador, Alt. & Toma Fuerza - Ventilador, Alt. & Toma Fuerza
Cummins ISC Diesel	2002	36093 38516	POLEA TENSOR	Tensora - Ventilador, Alt. & Toma Fuerza - Ventilador, Alt. & Toma Fuerza
Caterpillar 3126 Diesel	2001	36096 36091 38511	POLEA POLEA TENSOR	guía Tensora - Ventilador, Alt. & A.A. - Ventilador, Alt. & A.A.
Cummins ISB Diesel	2001	36093 38516	POLEA TENSOR	Tensora - Ventilador, Alt. - Ventilador & Alt.
Cummins ISC Diesel	2001	38525 38511	TENSOR TENSOR	- Ventilador, Alt. & Toma Fuerza - Ventilador, Alt. & A.A.
Caterpillar 3126 Diesel	2000	36091 36096 36091 38511	POLEA POLEA POLEA TENSOR	Tensora - Ventilador, Alt. & A.A. guía Tensora - Ventilador, Alt. & A.A. - Ventilador, Alt. & A.A.
Cummins ISB Diesel	2000	36093 38516	POLEA TENSOR	Tensora - Ventilador, B.A. & Alt. - Ventilador, B.A. & Alt.
Cummins ISC Diesel	2000	38525 36096	TENSOR POLEA	- Ventilador, Alt. & Toma Fuerza guía
Caterpillar 3126 Diesel	1999	36096 36091 38511	POLEA POLEA TENSOR	guía Tensora - Ventilador, Alt. & A.A. - Ventilador, Alt. & A.A.
Cummins ISB Diesel	1999	36093 38516	POLEA TENSOR	Tensora - Ventilador, B.A. & Alt. - Ventilador, B.A. & Alt.
Cummins ISC Diesel	1999	36093 38516	POLEA TENSOR	Tensora Tensora - Ventilador, B.A. & Alt. - Ventilador, B.A. & Alt.
Caterpillar 3126 Diesel	1997	36096 36091 38511	POLEA POLEA TENSOR	Tensora guía Tensora - Ventilador, Alt. & A.A. - Ventilador, Alt. & A.A.
Cummins B Series 5.9 L Diesel	1997	36093 38516	POLEA TENSOR	Tensora - Ventilador, B.A. & Alt. - Ventilador, B.A. & Alt.
Caterpillar 3126 Diesel	1996	36096 38511 36091	POLEA TENSOR POLEA	guía - Ventilador, Alt. & A.A. Tensora - Ventilador, Alt. & A.A.
Caterpillar 3126 Diesel	1995	36096 36091 38511	POLEA POLEA TENSOR	guía Tensora - Ventilador, Alt. & A.A. - Ventilador, Alt. & A.A.

**FL70**

Caterpillar C7 Diesel	2005	36091 36091	POLEA POLEA	guía - Lisa Tensora - Ventilador, Alt. & A.A.
-----------------------	------	----------------	----------------	--



Detroit Diesel 6-Cyl. 14.0 L Diesel	2008	38501	TENSOR	- Toma Fuerza, Alt. & A.A.	Detroit Diesel 6-Cyl. 14.0 L Diesel	2004	38075	POLEA	Tensora - Toma Fuerza, Alt. & A.A.
Caterpillar C11 Diesel	2007	38590	TENSOR	- Ventilador, Alt. & A.A.			38075	POLEA	Tensora - Toma Fuerza, Alt. & A.A.
		36093	POLEA	guía - ranurada			38501	TENSOR	- Toma Fuerza, Alt. & A.A.
Caterpillar C13 Diesel	2007	38590	TENSOR	- Ventilador, Alt. & A.A.	DETROIT DIESEL SERIE 60	2004	38501	TENSOR	Alt., Toma de Fuerza, C/AA
		36093	POLEA	guía - ranurada	Caterpillar C10 Diesel	2003	36091	POLEA	Tensora - Ventilador a A.A.
Caterpillar C15 Diesel	2007	38569	TENSOR	- Ventilador & Alt.			36091	POLEA	guía - Ventilador & Alt.
		36093	POLEA	guía - ranurada			38524	TENSOR	- Ventilador a A.A.
		36091	POLEA	guía - Lisa			38506	TENSOR	- Ventilador & Alt.
		38511	TENSOR	- Ventilador a A.A.	Caterpillar C12 Diesel	2003	36091	POLEA	Tensora - Ventilador a A.A.
		36091	POLEA	Tensora - Ventilador a A.A.			36091	POLEA	guía - Ventilador & Alt.
Detroit Diesel 6-Cyl. 12.7 L Diesel	2007	38503	TENSOR	- Ventilador			38506	TENSOR	- Ventilador & Alt.
		38076	POLEA	Tensora - Ventilador			38524	TENSOR	- Ventilador a A.A.
		38501	TENSOR	- Toma Fuerza, Alt. & A.A.	Caterpillar C15 Diesel	2003	36091	POLEA	Tensora - Ventilador & Alt.
		38075	POLEA	Tensora - Toma Fuerza, Alt. & A.A.			36091	POLEA	Tensora - Ventilador a A.A.
Detroit Diesel 6-Cyl. 14.0 L Diesel	2007	38076	POLEA	Tensora - Ventilador			38506	TENSOR	- Ventilador & Alt.
		38503	TENSOR	- Ventilador	Caterpillar C16 Diesel	2003	36091	POLEA	Tensora - Ventilador a A.A.
		38075	POLEA	Tensora - Toma Fuerza, Alt. & A.A.			36091	POLEA	- Ventilador & Alt.
		38501	TENSOR	- Toma Fuerza, Alt. & A.A.			38506	TENSOR	- Ventilador a A.A.
Caterpillar C11 Diesel	2006	38590	TENSOR	- Ventilador & Alt.			38508	TENSOR	- Ventilador a A.A.
		36093	POLEA	guía - ranurada			36091	POLEA	Tensora - Ventilador & Alt.
Caterpillar C13 Diesel	2006	38590	TENSOR	- Ventilador, Alt. & A.A.			36091	POLEA	Tensora - Ventilador a A.A.
		36093	POLEA	guía - ranurada			38506	TENSOR	- Ventilador & Alt.
Caterpillar C15 Diesel	2006	38569	TENSOR	- Ventilador & Alt.			38508	TENSOR	- Ventilador a A.A.
		36093	POLEA	guía - ranurada	Cummins ISM Diesel	2003	36091	POLEA	Tensora - A.A.
		36091	POLEA	guía - Lisa			38521	TENSOR	- Ventilador, Alt. & Toma Fuerza
		38511	TENSOR	- Ventilador a A.A.			38505	TENSOR	- Toma Fuerza & A.A.
Detroit Diesel 6-Cyl. 12.7 L Diesel	2006	36091	POLEA	Tensora - Ventilador a A.A.			36092	POLEA	Tensora - Ventilador
		38503	TENSOR	- Ventilador	Cummins ISX Diesel	2003	36095	POLEA	Tensora - Toma Fuerza, Alt. & A.A.
		38076	POLEA	Tensora - Ventilador			38532	TENSOR	- Toma Fuerza, Alt. & A.A.
		38075	POLEA	Tensora - Toma Fuerza, Alt. & A.A.	Detroit Diesel 6-Cyl. 12.7 L Diesel	2003	38535	TENSOR	- Ventilador
		38501	TENSOR	- Toma Fuerza, Alt. & A.A.			38501	TENSOR	- Toma Fuerza, Alt. & A.A.
Detroit Diesel 6-Cyl. 14.0 L Diesel	2006	38076	POLEA	Tensora - Ventilador			38075	POLEA	Tensora - Toma Fuerza, Alt. & A.A.
		38503	TENSOR	- Ventilador	DETROIT DIESEL SERIE 60	2003	38501	TENSOR	- Toma Fuerza, Alt. & A.A.
		38075	POLEA	Tensora - Toma Fuerza, Alt. & A.A.			38501	TENSOR	Alt., A.A., Toma de Fuerza
		38501	TENSOR	- Toma Fuerza, Alt. & A.A.	Caterpillar C10 Diesel	2002	36091	POLEA	Tensora - Ventilador a A.A.
DETROIT DIESEL SERIE 60	2006	38501	TENSOR	Toma de Fuerza, Alt. y A.A.			36091	POLEA	Tensora - Ventilador & Alt.
		38503	TENSOR	Vent.			36091	POLEA	guía - Ventilador & Alt.
Caterpillar C11 Diesel	2005	38590	TENSOR	- Ventilador, Alt. & A.A.			38524	TENSOR	- Ventilador a A.A.
		36093	POLEA	guía - ranurada			38506	TENSOR	- Ventilador & Alt.
Caterpillar C13 Diesel	2005	38590	TENSOR	- Ventilador, Alt. & A.A.	Caterpillar C12 Diesel	2002	36091	POLEA	Tensora - Ventilador & Alt.
		36093	POLEA	guía - ranurada			36091	POLEA	Tensora - Ventilador a A.A.
Caterpillar C15 Diesel	2005	38569	TENSOR	- Ventilador & Alt.			38506	TENSOR	- Ventilador & Alt.
		38511	TENSOR	- Ventilador a A.A.	Caterpillar C15 Diesel	2002	38524	TENSOR	- Ventilador a A.A.
		36091	POLEA	Tensora - Ventilador a A.A.			36091	POLEA	Tensora - Ventilador & Alt.
		36091	POLEA	guía - Lisa			36091	POLEA	Tensora - Ventilador a A.A.
		36093	POLEA	guía - ranurada			38506	TENSOR	- Ventilador & Alt.
Detroit Diesel 6-Cyl. 12.7 L Diesel	2005	38076	POLEA	Tensora - Ventilador			38508	TENSOR	- Ventilador a A.A.
		38075	POLEA	Tensora - Toma Fuerza, Alt. & A.A.	Caterpillar C16 Diesel	2002	36091	POLEA	Tensora - Ventilador a A.A.
		38503	TENSOR	- Ventilador			36091	POLEA	Tensora - Ventilador & Alt.
		38501	TENSOR	- Toma Fuerza, Alt. & A.A.			38508	TENSOR	- Ventilador a A.A.
Detroit Diesel 6-Cyl. 14.0 L Diesel	2005	38076	POLEA	Tensora - Ventilador			38506	TENSOR	- Ventilador & Alt.
		38503	TENSOR	- Ventilador	Cummins ISM Diesel	2002	36091	POLEA	Tensora - A.A.
		38501	TENSOR	- Toma Fuerza, Alt. & A.A.			38505	TENSOR	- Toma Fuerza & A.A.
		38075	POLEA	Tensora - Toma Fuerza, Alt. & A.A.			38521	TENSOR	- Ventilador, Alt. & Toma Fuerza
Caterpillar C10 Diesel	2004	36091	POLEA	Tensora - Ventilador a A.A.	Cummins ISX Diesel	2002	36092	POLEA	Tensora - Ventilador
		36091	POLEA	guía - Ventilador & Alt.			36095	POLEA	Tensora - Toma Fuerza, Alt. & A.A.
		38524	TENSOR	- Ventilador a A.A.			38535	TENSOR	- Ventilador
		38506	TENSOR	- Ventilador & Alt.			38532	TENSOR	- Toma Fuerza, Alt. & A.A.
Caterpillar C11 Diesel	2004	36093	POLEA	guía - ranurada	Detroit Diesel 6-Cyl. 11.1 L Diesel	2002	38501	TENSOR	- Toma Fuerza, Alt. & A.A.
Caterpillar C12 Diesel	2004	36091	POLEA	Tensora - Ventilador a A.A.			38075	POLEA	Tensora - Toma Fuerza, Alt. & A.A.
		36091	POLEA	guía - Ventilador & Alt.	Detroit Diesel 6-Cyl. 12.7 L Diesel	2002	38075	POLEA	Tensora - Toma Fuerza, Alt. & A.A.
		38524	TENSOR	- Ventilador a A.A.			38501	TENSOR	- Toma Fuerza, Alt. & A.A.
		38506	TENSOR	- Ventilador & Alt.			38501	TENSOR	- Toma Fuerza, Alt. & A.A.
Caterpillar C13 Diesel	2004	36093	POLEA	guía - ranurada	Detroit Diesel 6-Cyl. 14.0 L Diesel	2002	38501	TENSOR	Tensora - Toma Fuerza, Alt. & A.A.
Caterpillar C15 Diesel	2004	36091	POLEA	Tensora - Ventilador & Alt.			38075	POLEA	Tensora - Toma Fuerza, Alt. & A.A.
		36091	POLEA	guía - ranurada			38501	TENSOR	- Toma Fuerza, Alt. & A.A.
		36093	POLEA	guía - Lisa			38501	TENSOR	- Toma Fuerza, Alt. & A.A.
		38508	TENSOR	- Ventilador a A.A.			38075	POLEA	Tensora - Toma Fuerza, Alt. & A.A.
		38506	TENSOR	- Ventilador & Alt.	DETROIT DIESEL SERIE 60	2002	38501	TENSOR	Alt., A.A., Toma de Fuerza
Caterpillar C16 Diesel	2004	36091	POLEA	Tensora - Ventilador a A.A.			36091	POLEA	guía - Ventilador & Alt.
		36091	POLEA	Tensora - Ventilador a A.A.	Caterpillar C10 Diesel	2001	36091	POLEA	Tensora - Ventilador & Alt.
		38508	TENSOR	- Ventilador a A.A.			36091	POLEA	Tensora - Ventilador a A.A.
		38506	TENSOR	- Ventilador & Alt.			38506	TENSOR	- Ventilador & Alt.
		38508	TENSOR	- Ventilador a A.A.	Caterpillar C12 Diesel	2001	38524	TENSOR	- Ventilador a A.A.
Detroit Diesel 6-Cyl. 12.7 L Diesel	2004	38501	TENSOR	- Toma Fuerza, Alt. & A.A.			36091	POLEA	Tensora - Ventilador & Alt.
							36091	POLEA	guía - Ventilador & Alt.
							38506	TENSOR	- Ventilador & Alt.
							38524	TENSOR	- Ventilador a A.A.
							36091	POLEA	Tensora - Ventilador & Alt.
							36091	POLEA	Tensora - Ventilador a A.A.
							38506	TENSOR	- Ventilador & Alt.
							38524	TENSOR	- Ventilador a A.A.
							36091	POLEA	Tensora - Ventilador a A.A.
							38506	TENSOR	- Ventilador & Alt.
							38524	TENSOR	- Ventilador a A.A.
							36091	POLEA	Tensora - Ventilador a A.A.

Caterpillar C15 Diesel	2001	36091	POLEA	Tensora - Ventilador & Alt.
		38508	TENSOR	- Ventilador a A.A.
		38506	TENSOR	- Ventilador & Alt.
Caterpillar C16 Diesel	2001	36091	POLEA	Tensora - Ventilador & Alt.
		36091	POLEA	Tensora - Ventilador a A.A.
		38506	TENSOR	- Ventilador & Alt.
		38508	TENSOR	- Ventilador a A.A.
Cummins ISM Diesel	2001	38505	TENSOR	- Toma Fuerza & A.A.
		38521	TENSOR	- Ventilador & Alt.
		36092	POLEA	Tensora - Ventilador
Cummins ISX Diesel	2001	36091	POLEA	Tensora - A.A.
		38532	TENSOR	- Toma Fuerza, Alt. & A.A.
		38535	TENSOR	- Ventilador
		36095	POLEA	Tensora - Toma Fuerza, Alt. & A.A.
Detroit Diesel 6-Cyl. 11.1 L Diesel	2001	38501	TENSOR	- Toma Fuerza, Alt. & A.A.
		38075	POLEA	Tensora - Toma Fuerza, Alt. & A.A.
		38501	TENSOR	- Toma Fuerza, Alt. & A.A.
Detroit Diesel 6-Cyl. 12.7 L Diesel	2001	38075	POLEA	Tensora - Toma Fuerza, Alt. & A.A.
		38075	POLEA	Tensora - Toma Fuerza, Alt. & A.A.
		38501	TENSOR	- Toma Fuerza, Alt. & A.A.
Detroit Diesel 6-Cyl. 14.0 L Diesel	2001	38501	TENSOR	- Toma Fuerza, Alt. & A.A.
		36091	POLEA	Tensora - Ventilador & Alt.
		36091	POLEA	Tensora - Ventilador a A.A.
Caterpillar 3406 Diesel	2000	38506	TENSOR	- Ventilador & Alt.
		38508	TENSOR	- Ventilador a A.A.
		38508	TENSOR	Vent. y Alt.
		38506	TENSOR	Vent. y A.A.
CATERPILLAR 3406 E DIESEL	2000	38092	POLEA	Tensora - Alt. & A.A.
		36091	POLEA	guía - Ventilador & Alt.
		36091	POLEA	Tensora - Ventilador, Alt. & Toma Fuerza
		38506	TENSOR	- Ventilador, Alt. & Toma Fuerza
Caterpillar C10 Diesel	2000	38534	TENSOR	- Ventilador & A.A.
		36091	POLEA	guía - Ventilador & Alt.
		36091	POLEA	Tensora - Ventilador, Alt. & Toma Fuerza
		38092	POLEA	Tensora - Alt. & A.A.
Caterpillar C12 Diesel	2000	38534	TENSOR	- Ventilador & A.A.
		38506	TENSOR	- Ventilador, Alt. & Toma Fuerza
		36091	POLEA	Tensora - Ventilador & Alt.
		36091	POLEA	Tensora - Ventilador a A.A.
Caterpillar C15 Diesel	2000	38506	TENSOR	- Ventilador & Alt.
		38508	TENSOR	- Ventilador a A.A.
		36091	POLEA	Tensora - Ventilador & Alt.
		36091	POLEA	Tensora - Ventilador a A.A.
Caterpillar C16 Diesel	2000	38506	TENSOR	- Ventilador & Alt.
		38508	TENSOR	- Ventilador a A.A.
		36091	POLEA	Tensora - Ventilador & Alt.
		36091	POLEA	Tensora - Ventilador a A.A.
Cummins ISM Diesel	2000	38508	TENSOR	- Ventilador & Alt.
		36091	POLEA	Tensora - A.A.
		38521	TENSOR	- Ventilador, B.A. & Alt.
		38505	TENSOR	- Toma Fuerza & A.A.
Cummins ISX Diesel	2000	36092	POLEA	Tensora - Ventilador
		36095	POLEA	Tensora - Toma Fuerza, Alt. & A.A.
		38532	TENSOR	- Toma Fuerza, Alt. & A.A.
		38535	TENSOR	- Ventilador
Detroit Diesel 6-Cyl. 11.1 L Diesel	2000	38075	POLEA	Tensora - Toma Fuerza, Alt. & A.A.
		38501	TENSOR	- Toma Fuerza, Alt. & A.A.
		38501	TENSOR	- Toma Fuerza, Alt. & A.A.
Detroit Diesel 6-Cyl. 12.7 L Diesel	2000	38075	POLEA	Tensora - Toma Fuerza, Alt. & A.A.
		38075	POLEA	Tensora - Toma Fuerza, Alt. & A.A.
		36091	POLEA	Tensora - Ventilador & Alt.
Caterpillar 3406 Diesel	1999	36091	POLEA	Tensora - Ventilador & Alt.
		36091	POLEA	Tensora - Ventilador a A.A.
		38508	TENSOR	- Ventilador a A.A.
		38506	TENSOR	- Ventilador & Alt.
CATERPILLAR 3406 E DIESEL	1999	38508	TENSOR	Vent. y Alt.
		38506	TENSOR	Vent. y A.A.
		36091	POLEA	guía - Ventilador & Alt.
		36091	POLEA	Tensora - Ventilador & Alt.
Caterpillar C10 Diesel	1999	36091	POLEA	Tensora - Ventilador & Alt.
		38092	POLEA	Tensora - Alt. & A.A.
		38506	TENSOR	- Ventilador & Alt.
		38534	TENSOR	- Ventilador & A.A.
Caterpillar C12 Diesel	1999	38092	POLEA	Tensora - Alt. & A.A.
		36091	POLEA	guía - Ventilador & Alt.
		36091	POLEA	Tensora - Ventilador & Alt.
		38506	TENSOR	- Ventilador & Alt.
Cummins ISM Diesel	1999	38534	TENSOR	- Ventilador & A.A.
		36091	POLEA	Tensora - A.A.
		38505	TENSOR	- Toma Fuerza & A.A.
		36092	POLEA	Tensora - Ventilador
Cummins ISX Diesel	1999	38532	TENSOR	- Toma Fuerza, Alt. & A.A.

Caterpillar 3406 Diesel	1998	38535	TENSOR	- Ventilador
		36095	POLEA	Tensora - Toma Fuerza, Alt. & A.A.
		36091	POLEA	Tensora - Ventilador a A.A.
		36091	POLEA	Tensora - Ventilador & Alt.
Caterpillar C10 Diesel	1998	38506	TENSOR	- Ventilador & Alt.
		38508	TENSOR	- Ventilador a A.A.
		38092	POLEA	Tensora - Alt. & A.A.
		36091	POLEA	Tensora - Ventilador & Alt.
Caterpillar C12 Diesel	1998	38534	TENSOR	- Ventilador & A.A.
		38506	TENSOR	- Ventilador & Alt.
		38092	POLEA	Tensora - Alt. & A.A.
		36091	POLEA	Tensora - Ventilador & Alt.
Caterpillar C10 Diesel	1997	38534	TENSOR	- Ventilador & A.A.
		38506	TENSOR	- Ventilador & Alt.
		36091	POLEA	Tensora - Ventilador & Alt.
		38514	TENSOR	- Ventilador & Alt.
Caterpillar C12 Diesel	1997	36091	POLEA	Tensora - Ventilador & Alt.
		38514	TENSOR	- Ventilador & Alt.
Caterpillar C12 Diesel	1996	36091	POLEA	Tensora - Ventilador & Alt.
		38514	TENSOR	- Ventilador & Alt.

**FLD120**

DETROIT DIESEL SERIE 60	2001	38501	TENSOR	
		38075	POLEA	Loca
DETROIT DIESEL SERIE 60	2000	38501	TENSOR	
		38075	POLEA	Loca
DETROIT DIESEL SERIE 60	1999	38075	POLEA	Loca
		38501	TENSOR	

**INTERNATIONAL/NAVISTAR**

**3300**

International/Navistar DT466 Diesel	2004	36091	POLEA	Tensora
		38514	TENSOR	

**3800**

International/Navistar T444 Diesel	2002	38510	TENSOR	
International/Navistar DT466 Diesel	2001	36091	POLEA	Tensora - Ventilador, Alt. & Toma Fuerza
		38514	TENSOR	- Ventilador, Alt. & Toma Fuerza
International/Navistar T444 Diesel	2001	38510	TENSOR	
International/Navistar DT466 Diesel	2000	36091	POLEA	Tensora - Ventilador, Alt. & Toma Fuerza
		38514	TENSOR	- Ventilador, Alt. & Toma Fuerza
International/Navistar T444 Diesel	2000	38510	TENSOR	
International/Navistar DT466 Diesel	1999	36091	POLEA	Tensora
		38514	TENSOR	
International/Navistar T444 Diesel	1999	38510	TENSOR	
International/Navistar DT466 Diesel	1998	36091	POLEA	Tensora
		38514	TENSOR	
International/Navistar T444 Diesel	1998	38510	TENSOR	

**4100**

International/Navistar VT365 Diesel	2007	38556	TENSOR	- Ventilador, Alt. & A.A.
International/Navistar VT365 Diesel	2006	38556	TENSOR	- Ventilador, Alt. & A.A.

**4200**











International/Navistar VT365 Diesel	2007	38556	TENSOR	- Ventilador, Alt. & A.A.
International/Navistar VT365 Diesel	2006	38556	TENSOR	- Ventilador, Alt. & A.A.
International/Navistar VT365 Diesel	2005	38556	TENSOR	- Ventilador, Alt. & A.A.
International/Navistar VT365 Diesel	2004	38556	TENSOR	- Ventilador, Alt. & A.A.
International/Navistar VT365 Diesel	2003	38556	TENSOR	- Ventilador, Alt. & A.A.
International/Navistar VT365 Diesel	2002	38556	TENSOR	- Ventilador, Alt. & A.A.

**4300**

International/Navistar DT466 Diesel	2008	38620	TENSOR	- Ventilador, Alt. & A.A.
International/Navistar DT466 Diesel	2007	38620	TENSOR	- Ventilador, Alt. & A.A.
International/Navistar DT466 Diesel	2006	38620	TENSOR	- Ventilador, Alt. & A.A.
International/Navistar DT466 Diesel	2005	38620	TENSOR	- Ventilador, Alt. & A.A.





									
International/Navistar DT466 Diesel	2001	38511 36091 38514	TENSOR POLEA TENSOR	- Ventilador a A.A. Tensora - Ventilador & Alt. - Ventilador & Alt.	International/Navistar DT466 Diesel	1998	36091 38512 38514	POLEA TENSOR TENSOR	Tensora - Ventilador & A.A. - Ventilador & A.A. - Ventilador, Alt. & Toma Fuerza
International/Navistar DT466 Diesel	2000	36091 38511 38514 36091	POLEA TENSOR POLEA TENSOR	Tensora - Ventilador a A.A. - Ventilador a A.A. Tensora - Ventilador & Alt. - Ventilador & Alt.	International/Navistar 530 Diesel	1997	36091 38511 38514 36091	POLEA TENSOR POLEA TENSOR	Tensora - Ventilador & A.A. Tensora - Ventilador a A.A. - Ventilador & Alt. - Ventilador & Alt.
International/Navistar DT466 Diesel	1999	36091 36091 38511 38514	POLEA POLEA TENSOR TENSOR	Tensora - Ventilador a A.A. Tensora - Ventilador & Alt. - Ventilador a A.A. - Ventilador & Alt.	International/Navistar DT408 Diesel	1997	38511 36091 36091 38514	TENSOR POLEA POLEA TENSOR	Tensora - Ventilador & A.A. Tensora - Ventilador a A.A. Tensora - Ventilador & Alt. - Ventilador & A.A.
International/Navistar DT466 Diesel	1998	36091 36091 38511 38514	POLEA POLEA TENSOR TENSOR	Tensora - Ventilador a A.A. Tensora - Ventilador & Alt. - Ventilador a A.A. - Ventilador & Alt.	International/Navistar DT466 Diesel	1997	38511 36091 36091 38514	TENSOR POLEA POLEA TENSOR	- A.A. Tensora - Ventilador & Alt. Tensora - A.A. - Ventilador & Alt.
International/Navistar DT408 Diesel	1997	38511 36091 36091 38514	TENSOR POLEA POLEA TENSOR	- A.A. Tensora - Ventilador & Alt. Tensora - A.A. - Ventilador & Alt.	International/Navistar DT466 Diesel	1997	38511 36091 36091 38514	TENSOR POLEA POLEA TENSOR	- Ventilador a A.A. Tensora - Ventilador & Alt. Tensora - Ventilador a A.A. - Ventilador & Alt.
International/Navistar DT466 Diesel	1997	38511 36091 36091 38514	TENSOR POLEA POLEA TENSOR	- Ventilador a A.A. Tensora - Ventilador & Alt. Tensora - Ventilador a A.A. - Ventilador & Alt.	International/Navistar T444 Diesel	1997	38510	TENSOR	Tensora - Ventilador, Alt. & Toma Fuerza
International/Navistar T444 Diesel	1997	38510	TENSOR	- Ventilador a A.A.	International/Navistar 530 Diesel	1996	36091 36091 38514	POLEA POLEA TENSOR	Tensora - Ventilador & A.A. Tensora - Ventilador & A.A. - Ventilador & A.A.
International/Navistar DT466 Diesel	1996	36091 36091 38514	POLEA POLEA TENSOR	Tensora - Ventilador a A.A. Tensora - Ventilador & Alt. - Ventilador & Alt.	International/Navistar DT466 Diesel	1996	36091 36091 38511 38514	POLEA POLEA TENSOR TENSOR	Tensora - Ventilador a A.A. Tensora - Ventilador & Alt. - Ventilador a A.A. - Ventilador & Alt.
International/Navistar T444 Diesel	1996	38510	TENSOR	- A.A.	International/Navistar T444 Diesel	1996	38510	TENSOR	Tensora - Ventilador, Alt. & Toma Fuerza
International/Navistar DT408 Diesel	1995	38511 36091 36091 38514	TENSOR POLEA POLEA TENSOR	Tensora - Ventilador & Alt. Tensora - A.A. - Ventilador & Alt.	International/Navistar 530 Diesel	1995	36091 36091 38514 38512	POLEA POLEA TENSOR TENSOR	Tensora - Ventilador & A.A. Tensora - Ventilador & A.A. - Ventilador & A.A. - Ventilador & A.A.
International/Navistar DT466 Diesel	1995	36091 36091 38511 38514	POLEA POLEA TENSOR TENSOR	Tensora - Ventilador a A.A. Tensora - Ventilador & Alt. - Ventilador a A.A. - Ventilador & Alt.	International/Navistar DT408 Diesel	1995	36091 36091 38511 38514	POLEA POLEA TENSOR TENSOR	Tensora - A.A. Tensora - Ventilador & Alt. - A.A. - Ventilador & Alt.
International/Navistar T444 Diesel	1995	38510	TENSOR	- Ventilador & Alt.	International/Navistar DT466 Diesel	1995	36091 36091 38511 38514	POLEA POLEA TENSOR TENSOR	Tensora - Ventilador a A.A. Tensora - Ventilador & Alt. - Ventilador a A.A. - Ventilador & Alt.

**4900**

International/Navistar 530 Diesel	2002	36091 36091 38512 38514	POLEA POLEA TENSOR TENSOR	Tensora - Ventilador, Alt. & Toma Fuerza Tensora - Ventilador & A.A. - Ventilador & A.A. - Ventilador, Alt. & Toma Fuerza
International/Navistar DT466 Diesel	2002	36091 36091 38514 38512	POLEA POLEA TENSOR TENSOR	Tensora - Ventilador & Alt. Tensora - Ventilador a A.A. - Ventilador & Alt. - Ventilador a A.A.
International/Navistar 530 Diesel	2001	36091 36091 38514 38512	POLEA POLEA TENSOR TENSOR	Tensora - Ventilador, Alt. & Toma Fuerza Tensora - Ventilador & A.A. - Ventilador, Alt. & Toma Fuerza - Ventilador & A.A.
International/Navistar DT466 Diesel	2001	36091 36091 38512 38514	POLEA POLEA TENSOR TENSOR	Tensora - Ventilador & A.A. Tensora - Ventilador & Alt. - Ventilador & A.A. - Ventilador & Alt.
INTERNATIONAL/NAVISTAR DT530E	2001	38512 38514	TENSOR TENSOR	Vent. y A.A.
International/Navistar 530 Diesel	2000	36091 36091 38514 38512	POLEA POLEA TENSOR TENSOR	Tensora - Ventilador & A.A. Tensora - Ventilador, Alt. & Toma Fuerza - Ventilador, Alt. & Toma Fuerza - Ventilador & A.A.
International/Navistar DT466 Diesel	2000	36091 36091 38514 38512	POLEA POLEA TENSOR TENSOR	Tensora - Ventilador & A.A. Tensora - Ventilador & Alt. - Ventilador & Alt. - Ventilador & A.A.
International/Navistar 530 Diesel	1999	36091 36091 38514 38512	POLEA POLEA TENSOR TENSOR	Tensora - Ventilador & A.A. Tensora - Ventilador, Alt. & Toma Fuerza - Ventilador & A.A. - Ventilador & Alt.
International/Navistar DT466 Diesel	1999	36091 36091 38511 38514	POLEA POLEA TENSOR TENSOR	Tensora - Ventilador a A.A. Tensora - Ventilador & Alt. - Ventilador a A.A. - Ventilador & Alt.
International/Navistar 530 Diesel	1998	36091	POLEA	Tensora - Ventilador, Alt. & Toma Fuerza

**5000**





Caterpillar C12 Diesel	1999	36091 38506	POLEA TENSOR	Tensora - Ventilador & Alt. - Ventilador & Alt.
Caterpillar C12 Diesel	1998	36091 38506	POLEA TENSOR	Tensora - Ventilador & Alt. - Ventilador & Alt.

**5500**

CUMMINS ISM DIESEL	2005	38505 38521	TENSOR TENSOR	Toma de Fuerza y A.A. Vent. Y Alt.
--------------------	------	----------------	------------------	---------------------------------------

**5500i**

Caterpillar C13 Diesel	2007	38590 36093	TENSOR POLEA	- Ventilador, Alt. & A.A. guía - ranurada
Cummins ISX Diesel	2007	38587	TENSOR	- Ventilador & Alt.
Caterpillar C13 Diesel	2006	38590 36093	TENSOR POLEA	- Ventilador, Alt. & A.A. guía - ranurada
Cummins ISM Diesel	2006	38622 38505 36091	TENSOR TENSOR POLEA	- Ventilador & Alt. - Toma Fuerza & A.A. Tensora - A.A.
Cummins ISX Diesel	2006	38587	TENSOR	- Ventilador & Alt.
Caterpillar C13 Diesel	2005	38590 36093	TENSOR POLEA	- Ventilador, Alt. & A.A. guía - ranurada
Cummins ISM Diesel	2005	38622 36091 38505	TENSOR POLEA TENSOR	- Ventilador & Alt. Tensora - A.A. - Toma Fuerza & A.A.
Cummins ISX Diesel	2005	38587	TENSOR	- Ventilador & Alt.
Caterpillar C10 Diesel	2004	36091 36091 38506 38534	POLEA POLEA TENSOR TENSOR	- Ventilador, Alt. & A.A. Tensora - Ventilador & Alt. - Ventilador & Alt. - Ventilador a A.A.





				
Caterpillar C12 Diesel	2004	36091 36091 38506 38534	POLEA POLEA TENSOR TENSOR	guía - Ventilador & Alt. Tensora - Ventilador & Alt. - Ventilador & Alt. - Ventilador a A.A.
Cummins ISM Diesel	2004	38505 36091 38521	TENSOR POLEA TENSOR	- Toma Fuerza & A.A. Tensora - A.A. - Ventilador & Alt.
Cummins ISX Diesel	2004	38587	TENSOR	- Ventilador & Alt.
Caterpillar C10 Diesel	2003	36091 38534 36091 38506	POLEA TENSOR POLEA TENSOR	Tensora - Ventilador & Alt. guía - Ventilador & Alt. - Ventilador & Alt. - Ventilador & Alt.
Caterpillar C12 Diesel	2003	38534 36091 36091 38506	TENSOR POLEA POLEA TENSOR	- Ventilador a A.A. guía - Ventilador & Alt. Tensora - Ventilador & Alt. - Ventilador & Alt.
Cummins ISM Diesel	2003	38534 38505 36091 38521	TENSOR TENSOR POLEA TENSOR	- Ventilador a A.A. - Toma Fuerza & A.A. Tensora - A.A. - Ventilador & Alt.
Cummins ISX Diesel	2003	38587	TENSOR	- Ventilador & Alt.
Cummins ISM Diesel	2002	38505 36091 38521	TENSOR POLEA TENSOR	- Toma Fuerza & A.A. Tensora - A.A. - Ventilador & Alt.
International/Navistar DT466 Diesel	2002	36091 36091 38512 38514	POLEA POLEA TENSOR TENSOR	Tensora - Ventilador & A.A. Tensora - Ventilador & A.A. - Ventilador & A.A. - Ventilador & Alt.
International/Navistar DT466 Diesel	2001	36091 36091 38514 38512	POLEA POLEA TENSOR TENSOR	Tensora - Ventilador & A.A. Tensora - Ventilador & Alt. - Ventilador & Alt. - Ventilador & A.A.

**5600**

CUMMINS ISM DIESEL	2005	38505 38521	TENSOR TENSOR	Toma de Fuerza y A.A. Vent. Y Alt.
--------------------	------	----------------	------------------	---------------------------------------

**5600i**

Caterpillar C13 Diesel	2007	36093 38622	POLEA TENSOR	guía - ranurada - Ventilador & Alt.
Cummins ISM Diesel	2007	38505 36091	TENSOR POLEA	- Toma Fuerza & A.A. Tensora - A.A.
Cummins ISX Diesel	2007	38587	TENSOR	- Ventilador & Alt.
Caterpillar C13 Diesel	2006	36093	POLEA	guía - ranurada
Cummins ISM Diesel	2006	38622 38505	TENSOR TENSOR	- Ventilador & Alt. - Toma Fuerza & A.A.
Cummins ISX Diesel	2006	36091	POLEA	Tensora - A.A.
Caterpillar C13 Diesel	2005	38587 38590 36093	TENSOR TENSOR POLEA	- Ventilador & Alt. - Ventilador, Alt. & A.A. guía - ranurada
Cummins ISM Diesel	2005	38622 38505 36091	TENSOR TENSOR POLEA	- Ventilador & Alt. - Toma Fuerza & A.A. Tensora - A.A.
Cummins ISX Diesel	2005	38587	TENSOR	- Ventilador & Alt.
Caterpillar C10 Diesel	2004	36091 36091 38534 38506	POLEA POLEA TENSOR TENSOR	Tensora - Ventilador & Alt. guía - Ventilador & Alt. - Ventilador a A.A. - Ventilador & Alt.
Caterpillar C12 Diesel	2004	36091 36091 38534 38506	POLEA POLEA TENSOR TENSOR	Tensora - Ventilador & Alt. guía - Ventilador & Alt. - Ventilador a A.A. - Ventilador & Alt.
Caterpillar C15 Diesel	2004	38569 36091 38511	TENSOR POLEA TENSOR	- Ventilador & Alt. Tensora - Ventilador a A.A. - Ventilador a A.A.
Cummins ISM Diesel	2004	38505 36091 38521	TENSOR POLEA TENSOR	- Toma Fuerza & A.A. Tensora - A.A. - Ventilador & Alt.
Cummins ISX Diesel	2004	38587	TENSOR	- Ventilador & Alt.
Caterpillar C10 Diesel	2003	36091 36091 38506 36091	POLEA POLEA TENSOR POLEA	guía - Ventilador & Alt. Tensora - Ventilador & Alt. - Ventilador & Alt. - Ventilador & Alt.
Caterpillar C12 Diesel	2003	38534 36091 36091 38506	TENSOR POLEA POLEA TENSOR	- Ventilador a A.A. guía - Ventilador & Alt. Tensora - Ventilador & Alt. - Ventilador & Alt.
Caterpillar C10 Diesel	2003	36091 36091 38506 38534	POLEA POLEA TENSOR TENSOR	Tensora - Ventilador & Alt. guía - Ventilador & Alt. - Ventilador & Alt. - Ventilador a A.A.
Caterpillar C12 Diesel	2003	36091 36091 38506	POLEA POLEA TENSOR	Tensora - A.A. - Toma Fuerza & A.A. - Ventilador & Alt.

				
Cummins ISM Diesel	2003	38534 38505 36091 38521	TENSOR TENSOR POLEA TENSOR	- Ventilador a A.A. - Toma Fuerza & A.A. Tensora - A.A. - Ventilador & Alt.
Caterpillar C10 Diesel	2002	36091 36091 38506	POLEA POLEA TENSOR	Tensora - Ventilador & Alt. guía - Ventilador & Alt. - Ventilador & Alt.
Cummins ISM Diesel	2002	36091 38505 38521	POLEA TENSOR TENSOR	Tensora - A.A. - Toma Fuerza & A.A. - Ventilador & Alt.
International/Navistar DT466 Diesel	2002	36091 36091 38512	POLEA POLEA TENSOR	Tensora - Ventilador & Alt. Tensora - Ventilador & A.A. - Ventilador & A.A.
International/Navistar DT466 Diesel	2001	38514 36091 36091 38512 38514	TENSOR POLEA POLEA TENSOR TENSOR	- Ventilador & Alt. Tensora - Ventilador & Alt. Tensora - Ventilador & A.A. - Ventilador & A.A. - Ventilador & Alt.

**5900i**

Caterpillar C13 Diesel	2007	36093	POLEA	guía - ranurada
Cummins ISX Diesel	2007	38587	TENSOR	- Ventilador & Alt.
Caterpillar C13 Diesel	2006	36093	POLEA	guía - ranurada
Caterpillar C15 Diesel	2006	38569 38511 36091	TENSOR TENSOR POLEA	- Ventilador & Alt. - Ventilador a A.A. Tensora - Ventilador a A.A.
Cummins ISM Diesel	2006	38622 36091 38505	TENSOR POLEA TENSOR	- Ventilador & Alt. Tensora - A.A. - Toma Fuerza & A.A.
Cummins ISX Diesel	2006	38587	TENSOR	- Ventilador & Alt.
Caterpillar C13 Diesel	2005	36093	POLEA	guía - ranurada
Caterpillar C15 Diesel	2005	38569 36091 38511	TENSOR POLEA TENSOR	- Ventilador & Alt. Tensora - Ventilador a A.A. - Ventilador a A.A.
Cummins ISM Diesel	2005	38511 38622 36091 38505	TENSOR TENSOR POLEA TENSOR	- Ventilador a A.A. - Ventilador & Alt. Tensora - A.A. - Toma Fuerza & A.A.
Cummins ISX Diesel	2005	38587	TENSOR	- Ventilador & Alt.
Caterpillar C12 Diesel	2004	36091 36091 38534 38506	POLEA POLEA TENSOR TENSOR	Tensora - Ventilador & Alt. guía - Ventilador & Alt. - Ventilador a A.A. - Ventilador & Alt.
Caterpillar C15 Diesel	2004	38569 36091	TENSOR POLEA	- Ventilador & Alt. - Ventilador & Alt.
Cummins ISM Diesel	2004	36091 38505 38521	POLEA TENSOR TENSOR	Tensora - A.A. - Toma Fuerza & A.A. - Ventilador & Alt.
Cummins ISX Diesel	2004	38587	TENSOR	- Ventilador & Alt.
Caterpillar C10 Diesel	2003	36091 36091 38506	POLEA POLEA TENSOR	guía - Ventilador & Alt. Tensora - Ventilador & Alt. - Ventilador & Alt.
Cummins ISM Diesel	2003	38534 36091 36091 38506	TENSOR POLEA POLEA TENSOR	- Ventilador a A.A. guía - Ventilador & Alt. Tensora - Ventilador & Alt. - Ventilador & Alt.
Caterpillar C12 Diesel	2003	38506 36091 36091 38534	TENSOR POLEA POLEA TENSOR	- Ventilador a A.A. Tensora - Ventilador & Alt. Tensora - Ventilador & Alt. - Ventilador & Alt.
Cummins ISM Diesel	2003	38521 36091 38505	TENSOR POLEA TENSOR	- Ventilador & Alt. Tensora - A.A. - Toma Fuerza & A.A.
Cummins ISX Diesel	2003	38587	TENSOR	- Ventilador & Alt.
Caterpillar C10 Diesel	2002	36091 36091 38506	POLEA POLEA TENSOR	guía - Ventilador & Alt. Tensora - Ventilador & Alt. - Ventilador & Alt.
Caterpillar C12 Diesel	2002	36091 36091 38506	POLEA POLEA TENSOR	Tensora - Ventilador & Alt. guía - Ventilador & Alt. - Ventilador & Alt.
Cummins ISM Diesel	2002	36091 38505 38521	POLEA TENSOR TENSOR	Tensora - A.A. - Toma Fuerza & A.A. - Ventilador & Alt.
Cummins ISM Diesel	2001	36091 38505 38521	POLEA TENSOR TENSOR	Tensora - A.A. - Toma Fuerza & A.A. - Ventilador & Alt.
Caterpillar C10 Diesel	2000	36091 38506	POLEA TENSOR	Tensora - Ventilador & Alt. - Ventilador & Alt.

**7100**

International/Navistar DT466 Diesel	1995	38511	SENSOR	- Ventilador a A.A.
		36091	POLEA	Tensora - Ventilador & Alt.
		36091	POLEA	Tensora - Ventilador a A.A.
		38514	SENSOR	- Ventilador & Alt.

**7300**

International/Navistar DT466 Diesel	2006	38620	SENSOR	- Toma Fuerza, Ventilador, Alt. & A.A.
International/Navistar DT466 Diesel	2005	38620	SENSOR	- Toma Fuerza, Ventilador, Alt. & A.A.
International/Navistar DT466 Diesel	2003	38511	SENSOR	- Ventilador a A.A.
		36091	POLEA	Tensora - Ventilador & Alt.
		36091	POLEA	Tensora - Ventilador a A.A.
		38514	SENSOR	- Ventilador & Alt.
International/Navistar DT466 Diesel	2002	38511	SENSOR	- Ventilador a A.A.
		36091	POLEA	Tensora - Ventilador a A.A.
		36091	POLEA	Tensora - Ventilador & Alt.
		38514	SENSOR	- Ventilador & Alt.

**7400**

International/Navistar DT466 Diesel	2007	38620	SENSOR	- Toma Fuerza, Ventilador, Alt. & A.A.
International/Navistar DT570 Diesel	2007	38620	SENSOR	- Toma Fuerza, Ventilador, Alt. & A.A.
International/Navistar 570 Diesel	2006	38620	SENSOR	- Toma Fuerza, Ventilador, Alt. & A.A.
International/Navistar DT466 Diesel	2006	38620	SENSOR	- Toma Fuerza, Ventilador, Alt. & A.A.
Cummins ISM Diesel	2005	38622	SENSOR	- Ventilador & Alt.
		38505	SENSOR	- Toma Fuerza & A.A.
		36091	POLEA	Tensora - A.A.
International/Navistar DT466 Diesel	2005	38620	SENSOR	- Toma Fuerza, Ventilador, Alt. & A.A.
International/Navistar DT530 Diesel	2005	38511	SENSOR	- A.A.
		36091	POLEA	Tensora - A.A.
		36091	POLEA	Tensora - Ventilador, Alt. & Toma Fuerza
		38514	SENSOR	- Ventilador, Alt. & Toma Fuerza
International/Navistar DT570 Diesel	2005	38620	SENSOR	- Toma Fuerza, Ventilador, Alt. & A.A.
International/Navistar DT530 Diesel	2004	38511	SENSOR	- A.A.
		36091	POLEA	Tensora - A.A.
		36091	POLEA	Tensora - Ventilador, Alt. & Toma Fuerza
		38514	SENSOR	- Ventilador a A.A.
International/Navistar 530 Diesel	2003	38511	SENSOR	- Ventilador a A.A.
		36091	POLEA	Tensora - Ventilador, Alt. & Toma Fuerza
		36091	POLEA	Tensora - Ventilador a A.A.
		38514	SENSOR	- Ventilador, Alt. & Toma Fuerza
International/Navistar DT466 Diesel	2003	36091	POLEA	Tensora - Ventilador a A.A.
		38511	SENSOR	- Ventilador a A.A.
		36091	POLEA	Tensora - Ventilador & Alt.
		38514	SENSOR	- Ventilador & Alt.
International/Navistar 530 Diesel	2002	36091	POLEA	Tensora - Ventilador a A.A.
		36091	POLEA	Tensora - Ventilador, Alt. & Toma Fuerza
		38511	SENSOR	- Ventilador a A.A.
		38514	SENSOR	- Ventilador, Alt. & Toma Fuerza
International/Navistar DT466 Diesel	2002	36091	POLEA	Tensora - Ventilador a A.A.
		36091	POLEA	Tensora - Ventilador & Alt.
		38511	SENSOR	- Ventilador a A.A.
		38514	SENSOR	- Ventilador & Alt.

**7500**





International/Navistar HT570 Diesel	2007	38620	SENSOR	- Ventilador, Alt. & A.A.
International/Navistar HT570 Diesel	2006	38620	SENSOR	- Ventilador, Alt. & A.A.
International/Navistar DT530 Diesel	2005	36091	POLEA	Tensora - Ventilador & Alt.
		36091	POLEA	Tensora - Ventilador a A.A.
		38511	SENSOR	- Ventilador a A.A.
		38514	SENSOR	- Ventilador & Alt.
International/Navistar HT570 Diesel	2005	38620	SENSOR	- Ventilador, Alt. & A.A.
International/Navistar DT530 Diesel	2004	36091	POLEA	Tensora - Ventilador & Alt.
		36091	POLEA	Tensora - Ventilador a A.A.
		38511	SENSOR	- Ventilador a A.A.
		38514	SENSOR	- Ventilador & Alt.
International/Navistar 530 Diesel	2003	38511	SENSOR	- Ventilador a A.A.
		36091	POLEA	Tensora - Ventilador a A.A.
		36091	POLEA	Tensora - Ventilador, Alt. & Toma Fuerza
		38514	SENSOR	- Ventilador, Alt. & Toma Fuerza
International/Navistar 530 Diesel	2002	36091	POLEA	Tensora - Ventilador a A.A.
		38511	SENSOR	- Ventilador a A.A.





**7600**

International/Navistar DT466 Diesel	2002	36091	POLEA	Tensora - Ventilador, Alt. & Toma Fuerza
		38514	SENSOR	- Ventilador, Alt. & Toma Fuerza
		38511	SENSOR	- Ventilador a A.A.
		36091	POLEA	Tensora - Ventilador & Alt.
		36091	POLEA	Tensora - Ventilador a A.A.
		38514	SENSOR	- Ventilador & Alt.
Caterpillar C13 Diesel	2008	38590	SENSOR	- Ventilador, Alt. & A.A.
		36093	POLEA	guía - ranurada
Caterpillar C11 Diesel	2007	38590	SENSOR	- Ventilador, Alt. & A.A.
Caterpillar C13 Diesel	2007	38590	SENSOR	- Ventilador, Alt. & A.A.
		36093	POLEA	guía - ranurada
Cummins ISM Diesel	2007	38622	SENSOR	- Ventilador & Alt.
		38505	SENSOR	- Toma Fuerza & A.A.
		36091	POLEA	Tensora - A.A.
Caterpillar C11 Diesel	2006	38590	SENSOR	- Ventilador, Alt. & A.A.
Caterpillar C13 Diesel	2006	38590	SENSOR	- Ventilador, Alt. & A.A.
		36093	POLEA	guía - ranurada
Cummins ISM Diesel	2006	38622	SENSOR	- Ventilador & Alt.
		36091	POLEA	Tensora - A.A.
		38505	SENSOR	- Toma Fuerza & A.A.
Caterpillar C11 Diesel	2005	38590	SENSOR	- Ventilador, Alt. & A.A.
Caterpillar C13 Diesel	2005	38590	SENSOR	- Ventilador, Alt. & A.A.
		36093	POLEA	guía - ranurada
Cummins ISM Diesel	2005	38622	SENSOR	- Ventilador & Alt.
		36091	POLEA	Tensora - A.A.
		38505	SENSOR	- Toma Fuerza & A.A.
Caterpillar C10 Diesel	2004	36091	POLEA	guía - Ventilador & Alt.
		36091	POLEA	Tensora - Ventilador & Alt.
		38534	SENSOR	- Ventilador a A.A.
		38506	SENSOR	- Ventilador & Alt.
Caterpillar C11 Diesel	2004	38590	SENSOR	- Ventilador, Alt. & A.A.
Caterpillar C12 Diesel	2004	36091	POLEA	Tensora - Ventilador & Alt.
		36091	POLEA	guía - Ventilador & Alt.
		38534	SENSOR	- Ventilador a A.A.
		38506	SENSOR	- Ventilador & Alt.
Caterpillar C13 Diesel	2004	38590	SENSOR	- Ventilador, Alt. & A.A.
Cummins ISM Diesel	2004	36093	POLEA	guía - ranurada
		38505	SENSOR	- Toma Fuerza & A.A.
		36091	POLEA	Tensora - A.A.
		38521	SENSOR	- Ventilador & Alt.
Caterpillar C10 Diesel	2003	36091	POLEA	Tensora - Ventilador a A.A.
		36091	POLEA	Tensora - Ventilador & Alt.
		36091	POLEA	guía - Ventilador & Alt.
		38506	SENSOR	- Ventilador & Alt.
		38507	SENSOR	- Ventilador a A.A.
Caterpillar C12 Diesel	2003	36091	POLEA	Tensora - Ventilador & Alt.
		36091	POLEA	Tensora - Ventilador a A.A.
		36091	POLEA	guía - Ventilador & Alt.
		38506	SENSOR	- Ventilador & Alt.
		38507	SENSOR	- Ventilador a A.A.
Cummins ISM Diesel	2003	36091	POLEA	Tensora - A.A.
		38505	SENSOR	- Toma Fuerza & A.A.
		38521	SENSOR	- Ventilador & Alt.
Caterpillar C10 Diesel	2002	36091	POLEA	Tensora - Ventilador a A.A.
		36091	POLEA	Tensora - Ventilador & Alt.
		36091	POLEA	guía - Ventilador & Alt.
		38506	SENSOR	- Ventilador & Alt.
		38507	SENSOR	- Ventilador a A.A.
Caterpillar C12 Diesel	2002	36091	POLEA	guía - Ventilador & Alt.
		36091	POLEA	Tensora - Ventilador a A.A.
		38507	SENSOR	Tensora - Ventilador & Alt.
		38506	SENSOR	- Ventilador a A.A.

**7700**

Caterpillar C13 Diesel	2007	36093	POLEA	guía - ranurada
Caterpillar C11 Diesel	2006	38590	SENSOR	- Ventilador, Alt. & A.A.
Caterpillar C13 Diesel	2006	38590	SENSOR	- Ventilador, Alt. & A.A.
		36093	POLEA	guía - ranurada
Cummins ISM Diesel	2006	38622	SENSOR	- Ventilador & Alt.
		38505	SENSOR	- Toma Fuerza & A.A.
		36091	POLEA	Tensora - A.A.

					
Caterpillar C11 Diesel	2005	38590	SENSOR	- Ventilador, Alt. & A.A.	
Caterpillar C13 Diesel	2005	38590	SENSOR	- Ventilador, Alt. & A.A.	
		36093	POLEA	guía - ranurada	
Cummins ISM Diesel	2005	38622	SENSOR	- Ventilador & Alt.	
		36091	POLEA	Tensora - A.A.	
		38505	SENSOR	- Toma Fuerza & A.A.	

					
International/Navistar 530 Diesel			36091	POLEA	Tensora - Ventilador, Alt. & Toma Fuerza
			38511	SENSOR	- Ventilador, Alt. & Toma Fuerza
			38511	SENSOR	- A.A.
			36091	POLEA	Tensora - A.A.
International/Navistar DT466 Diesel	1995		36091	POLEA	Tensora - Ventilador & Alt.
			36091	POLEA	Tensora - A.A.
			38511	SENSOR	- A.A.
			38514	SENSOR	- Ventilador & Alt.

**8100**

Caterpillar C10 Diesel	2003	36091	POLEA	Tensora - Ventilador a A.A.
		36091	POLEA	guía - Ventilador & Alt.
		36091	POLEA	Tensora - Ventilador & Alt.
		38506	SENSOR	- Ventilador & Alt.
		38507	SENSOR	- Ventilador a A.A.
International/Navistar 530 Diesel	2003	36091	POLEA	Tensora - Ventilador, Alt. & Toma Fuerza
		36091	POLEA	Tensora - Ventilador & A.A.
		38512	SENSOR	- Ventilador & A.A.
		38514	SENSOR	- Ventilador, Alt. & Toma Fuerza
Caterpillar C10 Diesel	2002	36091	POLEA	guía - Ventilador & Alt.
		36091	POLEA	Tensora - Ventilador & Alt.
		36091	POLEA	Tensora - Ventilador a A.A.
		38507	SENSOR	- Ventilador & A.A.
		38506	SENSOR	- Ventilador & Alt.
International/Navistar 530 Diesel	2002	36091	POLEA	Tensora - Ventilador, Alt. & Toma Fuerza
		36091	POLEA	Tensora - Ventilador & A.A.
		38512	SENSOR	- Ventilador & A.A.
		38514	SENSOR	- Ventilador, Alt. & Toma Fuerza
International/Navistar 530 Diesel	2001	36091	POLEA	Tensora - Ventilador, Alt. & Toma Fuerza
		36091	POLEA	Tensora - Ventilador & A.A.
		38512	SENSOR	- Ventilador & A.A.
		38514	SENSOR	- Ventilador, Alt. & Toma Fuerza
International/Navistar 530 Diesel	2000	36091	POLEA	Tensora - Ventilador & A.A.
		36091	POLEA	Tensora - Ventilador, Alt. & Toma Fuerza
		38514	SENSOR	- Ventilador, Alt. & Toma Fuerza
		38512	SENSOR	- Ventilador & A.A.
International/Navistar DT466 Diesel	2000	38511	SENSOR	- A.A.
		36091	POLEA	Tensora - A.A.
		36091	POLEA	Tensora - Ventilador & Alt.
		38514	SENSOR	- Ventilador & Alt.
International/Navistar 530 Diesel	1999	36091	POLEA	Tensora - Ventilador & A.A.
		36091	POLEA	Tensora - Ventilador, Alt. & Toma Fuerza
		38512	SENSOR	- Ventilador & A.A.
		38514	SENSOR	- Ventilador, Alt. & Toma Fuerza
International/Navistar DT466 Diesel	1999	38511	SENSOR	- A.A.
		36091	POLEA	Tensora - A.A.
		36091	POLEA	Tensora - Ventilador & Alt.
		38514	SENSOR	- Ventilador & Alt.
International/Navistar 530 Diesel	1998	38511	SENSOR	- A.A.
		36091	POLEA	Tensora - Ventilador, Alt. & Toma Fuerza
		38514	SENSOR	- Ventilador, Alt. & Toma Fuerza
International/Navistar DT466 Diesel	1998	36091	POLEA	Tensora - Ventilador & Alt.
		38511	SENSOR	- A.A.
		36091	POLEA	Tensora - A.A.
		38514	SENSOR	- Ventilador & Alt.
Caterpillar 3176 Diesel	1997	36091	POLEA	Tensora
		38514	SENSOR	- Ventilador & Alt.
International/Navistar 530 Diesel	1997	38511	SENSOR	- A.A.
		36091	POLEA	Tensora - A.A.
		36091	POLEA	Tensora - Ventilador, Alt. & Toma Fuerza
		38514	SENSOR	- Ventilador, Alt. & Toma Fuerza
International/Navistar DT466 Diesel	1997	38511	SENSOR	- A.A.
		36091	POLEA	Tensora - Ventilador & Alt.
		36091	POLEA	Tensora - A.A.
		38514	SENSOR	- Ventilador & Alt.
Caterpillar 3176 Diesel	1996	36091	POLEA	Tensora
		38514	SENSOR	- Ventilador & Alt.
International/Navistar 530 Diesel	1996	38511	SENSOR	- A.A.
		36091	POLEA	Tensora - Ventilador, Alt. & Toma Fuerza
		36091	POLEA	Tensora - A.A.
		38514	SENSOR	- Ventilador, Alt. & Toma Fuerza
International/Navistar DT466 Diesel	1996	36091	POLEA	Tensora - Ventilador & Alt.
		38511	SENSOR	- A.A.
		36091	POLEA	Tensora - A.A.
		38514	SENSOR	- Ventilador & Alt.
Caterpillar 3176 Diesel	1995	36091	POLEA	Tensora - Ventilador & Alt.
		38514	SENSOR	- Ventilador & Alt.

**8200**

International/Navistar 530 Diesel	1997	38511	SENSOR	- A.A.
		36091	POLEA	Tensora - Ventilador, Alt. & Toma Fuerza
		36091	POLEA	Tensora - A.A.
		38514	SENSOR	- Ventilador, Alt. & Toma Fuerza
International/Navistar DT466 Diesel	1997	36091	POLEA	Tensora - Ventilador, Alt. & Toma Fuerza
		36091	POLEA	Tensora - A.A.
		38511	SENSOR	- A.A.
		38514	SENSOR	- Ventilador, Alt. & Toma Fuerza
International/Navistar 530 Diesel	1996	36091	POLEA	Tensora - A.A.
		36091	POLEA	Tensora - Ventilador, Alt. & Toma Fuerza
		38511	SENSOR	- A.A.
		38514	SENSOR	- Ventilador, Alt. & Toma Fuerza
Detroit Diesel 6-Cyl. 11.1 L Diesel	1995	36091	POLEA	Tensora - Ventilador
		38511	SENSOR	- Ventilador
Detroit Diesel 6-Cyl. 12.7 L Diesel	1995	38511	SENSOR	- Ventilador
		36091	POLEA	Tensora - Ventilador

**8500**

International/Navistar HT570 Diesel	2007	38620	SENSOR	- Ventilador, Alt. & A.A.
International/Navistar DT570 Diesel	2006	38620	SENSOR	- Ventilador, Alt. & A.A.
International/Navistar 530 Diesel	2005	38511	SENSOR	- Ventilador a A.A.
		36091	POLEA	Tensora - Ventilador a A.A.
		36091	POLEA	Tensora - Ventilador & Alt.
		38514	SENSOR	- Ventilador & Alt.
International/Navistar HT570 Diesel	2005	38620	SENSOR	- Ventilador, Alt. & A.A.
International/Navistar 530 Diesel	2004	38511	SENSOR	- Ventilador a A.A.
		36091	POLEA	Tensora - Ventilador a A.A.
		36091	POLEA	Tensora - Ventilador & Alt.
		38514	SENSOR	- Ventilador & Alt.
International/Navistar 530 Diesel	2003	36091	POLEA	Tensora - Ventilador a A.A.
		36091	POLEA	Tensora - Ventilador & Alt.
		38511	SENSOR	- Ventilador a A.A.
		38514	SENSOR	- Ventilador & Alt.
International/Navistar 530 Diesel	2002	36091	POLEA	Tensora - Ventilador & Alt.
		38511	SENSOR	- Ventilador a A.A.
		36091	POLEA	Tensora - Ventilador a A.A.
		38514	SENSOR	- Ventilador & Alt.

**8600**

Caterpillar C11 Diesel	2007	38590	SENSOR	- Ventilador, Alt. & A.A.
Caterpillar C13 Diesel	2007	38590	SENSOR	- Ventilador, Alt. & A.A.
		36093	POLEA	guía - ranurada
Cummins ISM Diesel	2007	38622	SENSOR	- Ventilador & Alt.
		36091	POLEA	Tensora - A.A.
		38505	SENSOR	- Toma Fuerza & A.A.
Caterpillar C11 Diesel	2006	38590	SENSOR	- Ventilador, Alt. & A.A.
Caterpillar C13 Diesel	2006	38590	SENSOR	- Ventilador, Alt. & A.A.
		36093	POLEA	guía - ranurada
Cummins ISM Diesel	2006	38622	SENSOR	- Ventilador & Alt.
		36091	POLEA	Tensora - A.A.
		38505	SENSOR	- Toma Fuerza & A.A.
Caterpillar C11 Diesel	2005	38590	SENSOR	- Ventilador, Alt. & A.A.
Caterpillar C13 Diesel	2005	38590	SENSOR	- Ventilador, Alt. & A.A.
		36093	POLEA	guía - ranurada
Cummins ISM Diesel	2005	38622	SENSOR	- Ventilador & Alt.
		36091	POLEA	Tensora - A.A.
		38505	SENSOR	- Toma Fuerza & A.A.
International/Navistar HT570 Diesel	2005	38620	SENSOR	- Ventilador, Alt. & A.A.
Caterpillar C10 Diesel	2004	36091	POLEA	Tensora - Ventilador & Alt.
		36091	POLEA	guía - Ventilador & Alt.
		36091	POLEA	Tensora - Ventilador a A.A.
		38507	SENSOR	- Ventilador a A.A.
		38506	SENSOR	- Ventilador & Alt.



Caterpillar C11 Diesel	2004	38590	SENSOR	- Ventilador, Alt. & A.A.
Caterpillar C12 Diesel	2004	36091	POLEA	Tensora - Ventilador & Alt.
		36091	POLEA	guía - Ventilador & Alt.
		36091	POLEA	Tensora - Ventilador a A.A.
		38506	SENSOR	- Ventilador & Alt.
		38507	SENSOR	- Ventilador a A.A.
Caterpillar C13 Diesel	2004	38590	SENSOR	- Ventilador, Alt. & A.A.
		36093	POLEA	guía - ranurada
Cummins ISM Diesel	2004	36091	POLEA	Tensora - A.A.
		38521	SENSOR	- Ventilador & Alt.
		38505	SENSOR	- Toma Fuerza & A.A.
Caterpillar C10 Diesel	2003	36091	POLEA	Tensora - Ventilador a A.A.
		36091	POLEA	Tensora - Ventilador & Alt.
		36091	POLEA	guía - Ventilador & Alt.
		38506	SENSOR	- Ventilador & Alt.
		38507	SENSOR	- Ventilador a A.A.
Caterpillar C12 Diesel	2003	36091	POLEA	Tensora - Ventilador & Alt.
		36091	POLEA	Tensora - Ventilador a A.A.
		36091	POLEA	guía - Ventilador & Alt.
		38506	SENSOR	- Ventilador & Alt.
		38507	SENSOR	- Ventilador a A.A.
Cummins ISM Diesel	2003	36091	POLEA	Tensora - A.A.
		38505	SENSOR	- Toma Fuerza & A.A.
		38521	SENSOR	- Ventilador & Alt.

**9100**

Detroit Diesel Series 60 Diesel	1999	36092	POLEA	Tensora - Ventilador
		38529	SENSOR	- Ventilador
Detroit Diesel Series 60 Diesel	1998	36092	POLEA	Tensora - Ventilador
		38519	SENSOR	- Ventilador

**9100i**

Cummins ISX Diesel	2003	36092	POLEA	Tensora - Ventilador
		36095	POLEA	Tensora - Toma Fuerza, Alt. & A.A.
		38535	SENSOR	- Ventilador
		38532	SENSOR	- Toma Fuerza, Alt. & A.A.
Detroit Diesel 6-Cyl. 12.7 L Diesel	2003	36092	POLEA	Tensora - Ventilador
		38529	SENSOR	- Ventilador
Cummins ISX Diesel	2002	36092	POLEA	Tensora - Ventilador
		36095	POLEA	Tensora - Toma Fuerza, Alt. & A.A.
		38535	SENSOR	- Ventilador
		38532	SENSOR	- Toma Fuerza, Alt. & A.A.
Cummins ISX Diesel	2001	36092	POLEA	Tensora - Ventilador
		36095	POLEA	Tensora - Toma Fuerza, Alt. & A.A.
		38535	SENSOR	- Ventilador
		38532	SENSOR	- Toma Fuerza, Alt. & A.A.
Detroit Diesel 6-Cyl. 12.7 L Diesel	2001	36092	POLEA	Tensora - Ventilador
		38529	SENSOR	- Ventilador
Detroit Diesel Series 60 Diesel	2000	36092	POLEA	Tensora - Ventilador
		38529	SENSOR	- Ventilador

**9200**

CUMMINS ISM DIESEL	2005	38505	SENSOR	Toma de Fuerza y A.A.
		38521	SENSOR	Vent. y Alt.
Detroit Diesel Series 60 Diesel	1999	36092	POLEA	Tensora - Ventilador
		38529	SENSOR	- Ventilador
Detroit Diesel Series 60 Diesel	1998	36092	POLEA	Tensora - Ventilador
		38519	SENSOR	- Ventilador
Detroit Diesel 6-Cyl. 11.1 L Diesel	1997	36092	POLEA	Tensora - Ventilador
		38519	SENSOR	- Ventilador
Detroit Diesel 6-Cyl. 12.7 L Diesel	1997	36092	POLEA	Tensora - Ventilador
		38519	SENSOR	- Ventilador
Detroit Diesel 6-Cyl. 11.1 L Diesel	1996	36092	POLEA	Tensora - Ventilador
		38519	SENSOR	- Ventilador
Detroit Diesel 6-Cyl. 12.7 L Diesel	1996	36092	POLEA	Tensora - Ventilador
		38519	SENSOR	- Ventilador
Caterpillar 3176 Diesel	1995	36091	POLEA	Tensora - Ventilador & Alt.
		38506	SENSOR	- Ventilador & Alt.
Detroit Diesel 6-Cyl. 11.1 L Diesel	1995	36092	POLEA	Tensora - Ventilador
		38519	SENSOR	- Ventilador
Detroit Diesel 6-Cyl. 12.7 L Diesel	1995	36092	POLEA	Tensora - Ventilador
		38519	SENSOR	- Ventilador

**9200i**

Caterpillar C13 Diesel	2007	36093	POLEA	guía - ranurada
Cummins ISM Diesel	2007	38622	SENSOR	- Ventilador & Alt.
		36091	POLEA	Tensora - A.A.
		38505	SENSOR	- Toma Fuerza & A.A.
Cummins ISX Diesel	2007	38587	SENSOR	- Ventilador & Alt.
Caterpillar C13 Diesel	2006	38590	SENSOR	- Ventilador, Alt. & A.A.
		36093	POLEA	guía - ranurada
Cummins ISM Diesel	2006	38622	SENSOR	- Ventilador & Alt.
		36091	POLEA	Tensora - A.A.
		38505	SENSOR	- Toma Fuerza & A.A.
Cummins ISX Diesel	2006	38587	SENSOR	- Ventilador & Alt.
Caterpillar C13 Diesel	2005	38590	SENSOR	- Ventilador, Alt. & A.A.
		36093	POLEA	guía - ranurada
Cummins ISM Diesel	2005	38622	SENSOR	- Ventilador & Alt.
		36091	POLEA	Tensora - A.A.
		38505	SENSOR	- Toma Fuerza & A.A.
Cummins ISX Diesel	2005	38587	SENSOR	- Ventilador & Alt.
Caterpillar C10 Diesel	2004	36091	POLEA	Tensora - Ventilador & Alt.
		36091	POLEA	guía - Ventilador & Alt.
		36091	POLEA	Tensora - Ventilador a A.A.
		38507	SENSOR	- Ventilador a A.A.
		38506	SENSOR	- Ventilador & Alt.
Caterpillar C12 Diesel	2004	36091	POLEA	Tensora - Ventilador a A.A.
		36091	POLEA	Tensora - Ventilador & Alt.
		36091	POLEA	guía - Ventilador & Alt.
		38507	SENSOR	- Ventilador a A.A.
		38506	SENSOR	- Ventilador & Alt.
Caterpillar C13 Diesel	2004	38590	SENSOR	- Ventilador, Alt. & A.A.
		36093	POLEA	guía - ranurada
Cummins ISM Diesel	2004	36091	POLEA	Tensora - A.A.
		38505	SENSOR	- Toma Fuerza & A.A.
		38521	SENSOR	- Ventilador & Alt.
Cummins ISX Diesel	2004	38587	SENSOR	- Ventilador & Alt.
Caterpillar C12 Diesel	2003	36091	POLEA	guía - Ventilador & Alt.
Cummins ISM Diesel	2003	36091	POLEA	Tensora - A.A.
		38521	SENSOR	- Ventilador & Alt.
		38505	SENSOR	- Toma Fuerza & A.A.
Cummins ISX Diesel	2003	38587	SENSOR	- Ventilador & Alt.
Cummins Signature 600 Diesel	2002	36092	POLEA	Tensora - Ventilador
		36095	POLEA	Tensora - Toma Fuerza, Alt. & A.A.
		38532	SENSOR	- Toma Fuerza, Alt. & A.A.
		38535	SENSOR	- Ventilador
Cummins Signature 600 Diesel	2001	36092	POLEA	Tensora - Ventilador
		38535	SENSOR	- Ventilador
		38532	SENSOR	- Toma Fuerza, Alt. & A.A.
		36095	POLEA	Tensora - Toma Fuerza, Alt. & A.A.
Detroit Diesel 6-Cyl. 12.7 L Diesel	2001	36092	POLEA	Tensora - Ventilador
		38529	SENSOR	- Ventilador
Cummins Signature 600 Diesel	2000	36092	POLEA	Tensora - Ventilador
		38532	SENSOR	- Toma Fuerza, Alt. & A.A.
		38535	SENSOR	- Ventilador
		36095	POLEA	Tensora - Toma Fuerza, Alt. & A.A.
Detroit Diesel Series 60 Diesel	2000	36092	POLEA	Tensora - Ventilador
		38529	SENSOR	- Ventilador

**9300**

Caterpillar 3176 Diesel	1995	36091	POLEA	Tensora - Ventilador & Alt.
		38506	SENSOR	- Ventilador & Alt.

**9400**

Detroit Diesel Series 60 Diesel	1999	36092	POLEA	Tensora - Ventilador
		38519	SENSOR	- Ventilador
Detroit Diesel Series 60 Diesel	1998	36092	POLEA	Tensora - Ventilador
		38519	SENSOR	- Ventilador
Detroit Diesel Series 60 Diesel	1997	36092	POLEA	Tensora - Ventilador
		38519	SENSOR	- Ventilador
Detroit Diesel 6-Cyl. 11.1 L Diesel	1996	36092	POLEA	Tensora - Ventilador
		38519	SENSOR	- Ventilador
Detroit Diesel 6-Cyl. 12.7 L Diesel	1996	36092	POLEA	Tensora - Ventilador
		38519	SENSOR	- Ventilador
Caterpillar 3176 Diesel	1995	36091	POLEA	Tensora - Ventilador & Alt.



Caterpillar 3176 Diesel	1995	38506	SENSOR	- Ventilador & Alt.
Detroit Diesel 6-Cyl. 11.1 L Diesel	1995	36092	POLEA	Tensora - Ventilador
		38519	TENSOR	- Ventilador
Detroit Diesel 6-Cyl. 12.7 L Diesel	1995	36092	POLEA	Tensora - Ventilador
		38519	TENSOR	- Ventilador



<b>9700</b>				
Detroit Diesel 6-Cyl. 11.1 L Diesel	1996	36092	POLEA	Tensora - Ventilador
		38519	TENSOR	- Ventilador
Detroit Diesel 6-Cyl. 12.7 L Diesel	1996	36092	POLEA	Tensora - Ventilador
		38519	TENSOR	- Ventilador

**9400i**

Caterpillar C13 Diesel	2007	38590	TENSOR	- Ventilador, Alt. & A.A.
		36093	POLEA	guía - ranurada
Caterpillar C15 Diesel	2007	38569	TENSOR	- Ventilador & Alt.
		38511	TENSOR	- Ventilador a A.A.
		36093	POLEA	guía - ranurada
		36091	POLEA	Tensora - Ventilador a A.A.
		36091	POLEA	guía - Lisa
Cummins ISM Diesel	2007	38622	TENSOR	- Ventilador & Alt.
		36091	POLEA	Tensora - A.A.
		38505	TENSOR	- Toma Fuerza & A.A.
Cummins ISX Diesel	2007	38587	TENSOR	- Ventilador & Alt.
Caterpillar C13 Diesel	2006	38590	TENSOR	- Ventilador, Alt. & A.A.
		36093	POLEA	guía - ranurada
Caterpillar C15 Diesel	2006	38569	TENSOR	- Ventilador & Alt.
		36093	POLEA	guía - ranurada
		38511	TENSOR	- Ventilador a A.A.
		36091	POLEA	Tensora - Ventilador a A.A.
		36091	POLEA	guía - Lisa
Cummins ISM Diesel	2006	38622	TENSOR	- Ventilador & Alt.
		36091	POLEA	Tensora - A.A.
		38505	TENSOR	- Toma Fuerza & A.A.
Cummins ISX Diesel	2006	38587	TENSOR	- Ventilador & Alt.
Caterpillar C13 Diesel	2005	38590	TENSOR	- Ventilador, Alt. & A.A.
		36093	POLEA	guía - ranurada
Caterpillar C15 Diesel	2005	38569	TENSOR	- Ventilador & Alt.
		38511	TENSOR	- Ventilador a A.A.
		36091	POLEA	guía - Lisa
		36091	POLEA	Tensora - Ventilador a A.A.
Cummins ISM Diesel	2005	36093	POLEA	guía - ranurada
		36091	POLEA	Tensora - A.A.
		38521	TENSOR	- Ventilador & Alt.
		38505	TENSOR	- Toma Fuerza & A.A.
Cummins ISX Diesel	2005	38587	TENSOR	- Ventilador & Alt.
Caterpillar C13 Diesel	2004	38590	TENSOR	- Ventilador, Alt. & A.A.
		36093	POLEA	guía - ranurada
Caterpillar C15 Diesel	2004	38569	TENSOR	- Ventilador & Alt.
		36091	POLEA	guía - Lisa
		36091	POLEA	Tensora - Ventilador a A.A.
		38511	TENSOR	- Ventilador a A.A.
		36093	POLEA	guía - ranurada
Cummins ISM Diesel	2004	36091	POLEA	Tensora - A.A.
		38521	TENSOR	- Ventilador & Alt.
		38505	TENSOR	- Toma Fuerza & A.A.
Cummins ISX Diesel	2004	38587	TENSOR	- Ventilador & Alt.
Cummins ISX Diesel	2003	38587	TENSOR	- Ventilador & Alt.
Cummins ISX Diesel	2002	36092	POLEA	Tensora - Ventilador
		36095	POLEA	Tensora - Toma Fuerza, Alt. & A.A.
		38532	TENSOR	- Toma Fuerza, Alt. & A.A.
		38535	TENSOR	- Ventilador
Cummins ISX Diesel	2001	36092	POLEA	Tensora - Ventilador
		38535	TENSOR	- Ventilador
		38532	TENSOR	- Toma Fuerza, Alt. & A.A.
		36095	POLEA	Tensora - Toma Fuerza, Alt. & A.A.
Detroit Diesel 6-Cyl. 12.7 L Diesel	2001	36092	POLEA	Tensora - Ventilador
		38519	TENSOR	- Ventilador
Cummins ISX Diesel	2000	36092	POLEA	Tensora - Ventilador
		38532	TENSOR	- Toma Fuerza, Alt. & A.A.
		38535	TENSOR	- Ventilador
		36095	POLEA	Tensora - Toma Fuerza, Alt. & A.A.
Detroit Diesel Series 60 Diesel	2000	36092	POLEA	Tensora - Ventilador
		38519	TENSOR	- Ventilador

**9600**

Detroit Diesel 6-Cyl. 11.1 L Diesel	1996	36092	POLEA	Tensora - Ventilador
		38519	TENSOR	- Ventilador
Detroit Diesel 6-Cyl. 12.7 L Diesel	1995	36092	POLEA	Tensora - Ventilador
		38519	TENSOR	- Ventilador

**9800**

Detroit Diesel Series 60 Diesel	1997	36092	POLEA	Tensora - Ventilador
		38519	TENSOR	- Ventilador

**9900**

Detroit Diesel Series 60 Diesel	1999	36092	POLEA	Tensora - Ventilador
		38519	TENSOR	- Ventilador

**9900i**

Caterpillar C13 Diesel	2007	36093	POLEA	guía - ranurada
Caterpillar C15 Diesel	2007	38569	TENSOR	- Ventilador & Alt.
		36091	POLEA	guía - Lisa
		36091	POLEA	Tensora - Ventilador a A.A.
		36093	POLEA	guía - ranurada
		38511	TENSOR	- Ventilador a A.A.
		38587	TENSOR	- Ventilador & Alt.
Cummins ISX Diesel	2007	38587	TENSOR	- Ventilador & Alt.
Caterpillar C13 Diesel	2006	36093	POLEA	guía - ranurada
Caterpillar C15 Diesel	2006	38569	TENSOR	- Ventilador & Alt.
		36093	POLEA	guía - ranurada
		36091	POLEA	guía - Lisa
		38511	TENSOR	- Ventilador a A.A.
		36091	POLEA	Tensora - Ventilador a A.A.
Cummins ISX Diesel	2006	38587	TENSOR	- Ventilador & Alt.
Caterpillar C13 Diesel	2005	36093	POLEA	guía - ranurada
Caterpillar C15 Diesel	2005	38569	TENSOR	- Ventilador & Alt.
		38511	TENSOR	- Ventilador a A.A.
		36091	POLEA	Tensora - Ventilador a A.A.
		36091	POLEA	guía - Lisa
		36093	POLEA	guía - ranurada
Cummins ISX Diesel	2005	38587	TENSOR	- Ventilador & Alt.
Caterpillar C12 Diesel	2004	36091	POLEA	guía - Ventilador & Alt.
Caterpillar C13 Diesel	2004	36093	POLEA	guía - ranurada
Caterpillar C15 Diesel	2004	38569	TENSOR	- Ventilador & Alt.
		36091	POLEA	Tensora - Ventilador a A.A.
		38511	TENSOR	- Ventilador a A.A.
		36091	POLEA	guía - Lisa
		36093	POLEA	guía - ranurada
Cummins ISX Diesel	2004	38587	TENSOR	- Ventilador & Alt.
Caterpillar C12 Diesel	2003	36091	POLEA	guía - Ventilador & Alt.
Cummins ISX Diesel	2003	38587	TENSOR	- Ventilador & Alt.
		36092	POLEA	Tensora - Ventilador
		38532	TENSOR	- Toma Fuerza, Alt. & A.A.
		36095	POLEA	Tensora - Toma Fuerza, Alt. & A.A.
		38535	TENSOR	- Ventilador
Cummins ISX Diesel	2002	36092	POLEA	Tensora - Ventilador
		38535	TENSOR	- Ventilador
		38532	TENSOR	- Toma Fuerza, Alt. & A.A.
		36095	POLEA	Tensora - Toma Fuerza, Alt. & A.A.
Cummins ISX Diesel	2001	36092	POLEA	Tensora - Ventilador
		38532	TENSOR	- Toma Fuerza, Alt. & A.A.
		36095	POLEA	Tensora - Toma Fuerza, Alt. & A.A.
		38535	TENSOR	- Ventilador
Detroit Diesel 6-Cyl. 12.7 L Diesel	2001	36092	POLEA	Tensora - Ventilador
		38519	TENSOR	- Ventilador
Cummins ISX Diesel	2000	36092	POLEA	Tensora - Ventilador
		36095	POLEA	Tensora - Toma Fuerza, Alt. & A.A.
		38535	TENSOR	- Ventilador
		38532	TENSOR	- Toma Fuerza, Alt. & A.A.
Detroit Diesel Series 60 Diesel	2000	36092	POLEA	Tensora - Ventilador
		38519	TENSOR	- Ventilador

**9900ix**

Caterpillar C15 Diesel	2007	38569	TENSOR	- Ventilador & Alt.
		36091	POLEA	guía - Lisa

Caterpillar C15 Diesel	2007	36091	POLEA	Tensora - Ventilador a A.A.
		36093	POLEA	guía - ranurada
		38511	TENSOR	- Ventilador a A.A.
Cummins ISX Diesel	2007	38587	TENSOR	- Ventilador & Alt.
Caterpillar C15 Diesel	2006	38569	TENSOR	- Ventilador & Alt.
		36093	POLEA	guía - ranurada
		36091	POLEA	guía - Lisa
		36091	POLEA	Tensora - Ventilador a A.A.
		38511	TENSOR	- Ventilador a A.A.
Cummins ISX Diesel	2006	38587	TENSOR	- Ventilador & Alt.
Caterpillar C15 Diesel	2005	38569	TENSOR	- Ventilador & Alt.
		36091	POLEA	guía - Lisa
		38511	TENSOR	- Ventilador a A.A.
		36091	POLEA	Tensora - Ventilador a A.A.
		36093	POLEA	guía - ranurada
Cummins ISX Diesel	2005	38587	TENSOR	- Ventilador & Alt.
Caterpillar C15 Diesel	2004	38569	TENSOR	- Ventilador & Alt.
		36091	POLEA	Tensora - Ventilador a A.A.
		36091	POLEA	guía - Lisa
		36093	POLEA	guía - ranurada
		38511	TENSOR	- Ventilador a A.A.
Cummins ISX Diesel	2004	38587	TENSOR	- Ventilador & Alt.
Caterpillar C12 Diesel	2003	36091	POLEA	guía - Ventilador & Alt.
Cummins ISX Diesel	2003	38587	TENSOR	- Ventilador & Alt.
		36092	POLEA	Tensora - Ventilador
		36095	POLEA	Tensora - Toma Fuerza, Alt. & A.A.
		38535	TENSOR	- Ventilador
		38532	TENSOR	- Toma Fuerza, Alt. & A.A.
Cummins ISX Diesel	2002	36092	POLEA	Tensora - Ventilador
		36095	POLEA	Tensora - Toma Fuerza, Alt. & A.A.
		38535	TENSOR	- Ventilador
		38532	TENSOR	- Toma Fuerza, Alt. & A.A.
Cummins ISX Diesel	2001	36092	POLEA	Tensora - Ventilador
		36092	POLEA	Tensora - Ventilador
		38519	TENSOR	- Ventilador
		36092	POLEA	Tensora - Ventilador
		38532	TENSOR	- Toma Fuerza, Alt. & A.A.
		36095	POLEA	Tensora - Toma Fuerza, Alt. & A.A.
		38535	TENSOR	- Ventilador
Detroit Diesel 6-Cyl. 12.7 L Diesel	2001	36092	POLEA	Tensora - Ventilador
		38519	TENSOR	- Ventilador
Cummins ISX Diesel	2000	36092	POLEA	Tensora - Ventilador
		38532	TENSOR	- Toma Fuerza, Alt. & A.A.
		36095	POLEA	Tensora - Toma Fuerza, Alt. & A.A.
		38535	TENSOR	- Ventilador
Detroit Diesel Series 60 Diesel	2000	36092	POLEA	Tensora - Ventilador
		38519	TENSOR	- Ventilador

**BE**

International/Navistar MaxxForce 7 Diesel	2008	38556	TENSOR	- Ventilador & Alt.
International/Navistar VT365 Diesel	2008	38556	TENSOR	- Ventilador & Alt.
International/Navistar VT365 Diesel	2007	38556	TENSOR	- Ventilador & Alt.

**CE**

International/Navistar DT466 Diesel	2008	38620	TENSOR	
International/Navistar MaxxForce DT Diesel	2008	38620	TENSOR	
International/Navistar DT466 Diesel	2007	38620	TENSOR	- Ventilador, B.A. & Alt.
International/Navistar VT365 Diesel	2007	38556	TENSOR	- Ventilador & Alt.
		38556	TENSOR	- Ventilador & Comprs. Frenos Aire
International/Navistar DT466 Diesel	2006	38620	TENSOR	- Ventilador, B.A. & Alt.
International/Navistar DT466 Diesel	2005	38620	TENSOR	- Ventilador, B.A. & Alt.
International/Navistar VT365 Diesel	2005	38556	TENSOR	
International/Navistar DT466 Diesel	2004	36091	POLEA	Tensora - Ventilador & Alt.
		38514	TENSOR	- Ventilador & Alt.
International/Navistar T444 Diesel	2004	38510	TENSOR	- Ventilador & Alt.
International/Navistar DT466 Diesel	2003	36091	POLEA	Tensora - Ventilador & Alt.
		38514	TENSOR	- Ventilador & Alt.
International/Navistar T444 Diesel	2003	38510	TENSOR	- Ventilador & Alt.

**CONVENTIONAL IC**

International/Navistar DT466 Diesel	2003	36091	POLEA	Tensora - Ventilador, Alt. & Toma Fuerza
		38514	TENSOR	- Ventilador, Alt. & Toma Fuerza
International/Navistar T444 Diesel	2003	36092	POLEA	Tensora
		38510	TENSOR	
International/Navistar DT466 Diesel	2002	36091	POLEA	Tensora - Ventilador, Alt. & Toma Fuerza
		38514	TENSOR	- Ventilador, Alt. & Toma Fuerza

International/Navistar T444 Diesel		38510	TENSOR	- Ventilador, Alt. & Toma Fuerza

**CXT**

International/Navistar DT466 Diesel	2006	38620	TENSOR	- Toma Fuerza, Ventilador, Alt. & A.A.
International/Navistar DT466 Diesel	2005	38620	TENSOR	- Toma Fuerza, Ventilador, Alt. & A.A.

**DURASTAR 4300**

International/Navistar MaxxForce 7 Diesel	2008	38556	TENSOR	- Ventilador, Alt. & A.A.
International/Navistar MaxxForce DT Diesel	2008	38556	TENSOR	- Ventilador, Alt. & A.A.

**FE**

International/Navistar DT466 Diesel	2005	38620	TENSOR	
International/Navistar DT466 Diesel	2004	36091	POLEA	Tensora
		38514	TENSOR	
International/Navistar DT466 Diesel	2003	36091	POLEA	Tensora
		38514	TENSOR	
International/Navistar DT466 Diesel	2002	36091	POLEA	Tensora
		38514	TENSOR	

**PAYSTAR 5500i**

Cummins ISX Diesel	2008	38587	TENSOR	- Ventilador & Alt.
--------------------	------	-------	--------	---------------------

**PAYSTAR 5600i**

Caterpillar C15 Diesel	2008	38569	TENSOR	- Ventilador & Alt.
		36091	POLEA	guía - Lisa
		36091	POLEA	Tensora - Ventilador a A.A.
		36093	POLEA	guía - ranurada
		38511	TENSOR	- Ventilador a A.A.

**PAYSTAR 5900i**

Cummins ISX Diesel	2008	38587	TENSOR	- Ventilador & Alt.
--------------------	------	-------	--------	---------------------

**PROSTAR SERIES**

Cummins ISX Diesel	2008	38521	TENSOR	- Ventilador & Alt.
--------------------	------	-------	--------	---------------------

**RE**

International/Navistar DT466 Diesel	2007	38620	TENSOR	- Ventilador, B.A. & Alt.
International/Navistar DT466 Diesel	2006	38620	TENSOR	- Ventilador, B.A. & Alt.
International/Navistar DT466 Diesel	2005	38620	TENSOR	- Ventilador, B.A. & Alt.
International/Navistar 530 Diesel	2004	36091	POLEA	Tensora - Ventilador & Alt.
		38514	TENSOR	- Ventilador & Alt.
International/Navistar DT466 Diesel	2004	38620	TENSOR	- Ventilador, B.A. & Alt.
International/Navistar 530 Diesel	2003	36091	POLEA	Tensora - Ventilador & Alt.
		38514	TENSOR	- Ventilador & Alt.
International/Navistar DT466 Diesel	2003	38620	TENSOR	- Ventilador, B.A. & Alt.
International/Navistar 530 Diesel	2002	36091	POLEA	Tensora - Ventilador & Alt.
		38514	TENSOR	- Ventilador & Alt.
International/Navistar DT466 Diesel	2002	38620	TENSOR	- Ventilador, B.A. & Alt.
International/Navistar 530 Diesel	2001	36091	POLEA	Tensora - Ventilador & Alt.
		38514	TENSOR	- Ventilador & Alt.
International/Navistar DT466 Diesel	2001	38620	TENSOR	- Ventilador, B.A. & Alt.
International/Navistar 530 Diesel	2000	36091	POLEA	Tensora - Ventilador & Alt.
		38514	TENSOR	- Ventilador & Alt.
International/Navistar DT466 Diesel	2000	38620	TENSOR	- Ventilador, B.A. & Alt.
International/Navistar 530 Diesel	1999	36091	POLEA	Tensora - Ventilador & Alt.
		38514	TENSOR	- Ventilador & Alt.
International/Navistar DT466 Diesel	1999	38620	TENSOR	- Ventilador, B.A. & Alt.
International/Navistar 530 Diesel	1998	36091	POLEA	Tensora - Ventilador & Alt.
		38514	TENSOR	- Ventilador & Alt.
International/Navistar DT466 Diesel	1998	38620	TENSOR	- Ventilador, B.A. & Alt.

**RXT**

International/Navistar DT570 Diesel	2006	38620	TENSOR	- Toma Fuerza, Ventilador, Alt. & A.A.
-------------------------------------	------	-------	--------	--

**TRANSTAR 8500**

Caterpillar C13 Diesel	2008	36093	POLEA	guía - ranurada
------------------------	------	-------	-------	-----------------

**TRANSTAR 8600**

Caterpillar C13 Diesel	2008	36093	POLEA	guía - ranurada
Cummins ISM Diesel	2008	38622	SENSOR	- Ventilador & Alt.
		36091	POLEA	Tensora - A.A.
		38505	SENSOR	- Toma Fuerza & A.A.

Caterpillar C10 Diesel	1998	36091	POLEA	Tensora - A.A.
		38505	SENSOR	- Ventilador & Alt.
Caterpillar C12 Diesel	1998	36091	POLEA	Tensora - A.A.
		38505	SENSOR	- Ventilador & Alt.
Caterpillar C10 Diesel	1997	36091	POLEA	Tensora - A.A.
		38505	SENSOR	- Ventilador & Alt.
Caterpillar C12 Diesel	1997	36091	POLEA	Tensora - A.A.

**WORKSTAR 7600**

Cummins ISM Diesel	2008	38622	SENSOR	- Ventilador & Alt.
		36091	POLEA	Tensora - A.A.
		38505	SENSOR	- Toma Fuerza & A.A.

**T300**

Caterpillar C7 Diesel	2007	38586	SENSOR	- Ventilador, Alt. & A.A.
		36096	POLEA	guía
Caterpillar C7 Diesel	2006	38586	SENSOR	- Ventilador, Alt. & A.A.
		36091	POLEA	guía - Lisa
		36096	POLEA	guía
Cummins ISC Diesel	2006	38516	SENSOR	- Ventilador, Alt. & A.A.
Caterpillar C7 Diesel	2005	38586	SENSOR	- Ventilador, Alt. & A.A.
		36096	POLEA	guía
		36091	POLEA	guía - Lisa
Cummins ISB Diesel	2005	38517	SENSOR	- Ventilador, Alt. & A.A.
Cummins ISC Diesel	2005	38516	SENSOR	- Ventilador & Alt.
Caterpillar C7 Diesel	2004	38586	SENSOR	- Ventilador, Alt. & A.A.
		36096	POLEA	guía
		36091	POLEA	guía - Lisa
Cummins ISC Diesel	2004	36093	POLEA	Tensora - Ventilador, Alt. & Toma Fuerza
		38516	SENSOR	- Ventilador, Alt. & Toma Fuerza
Caterpillar 3126 Diesel	2003	36091	POLEA	Tensora - Ventilador, Alt. & A.A.
		38511	SENSOR	- Ventilador, Alt. & A.A.
Cummins ISC Diesel	2003	36093	POLEA	Tensora - Ventilador, Alt. & Toma Fuerza
		38516	SENSOR	- Ventilador, Alt. & Toma Fuerza
Caterpillar 3126 Diesel	2002	36091	POLEA	Tensora - Ventilador, Alt. & A.A.
		38511	SENSOR	- Ventilador, Alt. & A.A.
Cummins ISC Diesel	2002	36093	POLEA	Tensora - Ventilador, Alt. & Toma Fuerza
		38516	SENSOR	- Ventilador, Alt. & Toma Fuerza
Caterpillar 3126 Diesel	2001	36091	POLEA	Tensora - Ventilador, Alt. & A.A.
		38511	SENSOR	- Ventilador, Alt. & A.A.
Cummins ISC Diesel	2001	36093	POLEA	Tensora - Ventilador, Alt. & Toma Fuerza
		38516	SENSOR	- Ventilador, Alt. & Toma Fuerza
Caterpillar 3126 Diesel	2000	36091	POLEA	Tensora - Ventilador, Alt. & A.A.
		38511	SENSOR	- Ventilador, Alt. & A.A.
Cummins ISC Diesel	2000	38527	SENSOR	- Ventilador, Alt. & Toma Fuerza
Caterpillar 3126 Diesel	1999	36091	POLEA	Tensora - Ventilador, Alt. & A.A.
		38511	SENSOR	- Ventilador, Alt. & A.A.
Cummins ISC Diesel	1999	38513	SENSOR	- Ventilador, Alt. & Toma Fuerza
Caterpillar 3126 Diesel	1998	36091	POLEA	Tensora - Ventilador, Alt. & A.A.
		38511	SENSOR	- Ventilador, Alt. & A.A.
Caterpillar 3126 Diesel	1997	36091	POLEA	Tensora - Ventilador, Alt. & A.A.
		38511	SENSOR	- Ventilador & Alt.
Caterpillar 3126 Diesel	1996	36091	POLEA	Tensora - Ventilador, Alt. & A.A.
		38511	SENSOR	- Ventilador & Alt.

**WORKSTAR 7700**

Caterpillar C13 Diesel	2008	36093	POLEA	guía - ranurada
------------------------	------	-------	-------	-----------------

**KENWORTH****T2000**

Caterpillar C15 Diesel	2007	38569	SENSOR	- Ventilador & Alt.
		36091	POLEA	Tensora - Ventilador a A.A.
		36091	POLEA	guía - Lisa
		36093	POLEA	guía - ranurada
		38511	SENSOR	- Ventilador a A.A.
Caterpillar C15 Diesel	2006	38569	SENSOR	- Ventilador & Alt.
		36091	POLEA	Tensora - Ventilador a A.A.
		36093	POLEA	guía - ranurada
		38511	SENSOR	- Ventilador a A.A.
Cummins ISX Diesel	2006	36091	POLEA	guía - Lisa
Caterpillar C15 Diesel	2005	38587	SENSOR	- Ventilador & Alt.
		38569	SENSOR	- Ventilador & Alt.
		36091	POLEA	guía - Lisa
		38511	SENSOR	- Ventilador a A.A.
		36091	POLEA	Tensora - Ventilador a A.A.
Cummins ISX Diesel	2005	38587	SENSOR	- Ventilador & Alt.
Caterpillar C15 Diesel	2004	38569	SENSOR	- Ventilador & Alt.
		36091	POLEA	Tensora - Ventilador a A.A.
		36091	POLEA	guía - Lisa
		38511	SENSOR	- Ventilador a A.A.
		36093	POLEA	guía - ranurada
Cummins ISX Diesel	2004	38587	SENSOR	- Ventilador & Alt.
Cummins ISX Diesel	2003	36092	POLEA	Tensora - Ventilador
		36095	POLEA	Tensora - Toma Fuerza, Alt. & A.A.
		38532	SENSOR	- Toma Fuerza, Alt. & A.A.
		38535	SENSOR	- Ventilador
Cummins ISX Diesel	2002	36092	POLEA	Tensora - Ventilador
		38532	SENSOR	- Toma Fuerza, Alt. & A.A.
		36095	POLEA	Tensora - Toma Fuerza, Alt. & A.A.
Cummins ISX Diesel	2001	36092	POLEA	Tensora - Ventilador
		38532	SENSOR	- Toma Fuerza, Alt. & A.A.
		38535	SENSOR	- Ventilador
Cummins ISX Diesel	2000	36092	POLEA	Tensora - Toma Fuerza, Alt. & A.A.
		36095	POLEA	Tensora - Ventilador
		38532	SENSOR	- Toma Fuerza, Alt. & A.A.
		36095	POLEA	Tensora - Toma Fuerza, Alt. & A.A.
Detroit Diesel 6-Cyl. 11.1 L Diesel	2000	38535	SENSOR	- Ventilador
		38075	POLEA	Tensora - Toma Fuerza, Alt. & A.A.
		38501	SENSOR	- Toma Fuerza, Alt. & A.A.
Detroit Diesel 6-Cyl. 12.7 L Diesel	2000	38075	POLEA	Tensora - Toma Fuerza, Alt. & A.A.
		38501	SENSOR	- Toma Fuerza, Alt. & A.A.
Caterpillar C10 Diesel	1999	36091	POLEA	Tensora - A.A.
		38505	SENSOR	- Ventilador & Alt.
Caterpillar C12 Diesel	1999	36091	POLEA	Tensora - A.A.
		38505	SENSOR	- Ventilador & Alt.
Cummins ISX Diesel	1999	36092	POLEA	Tensora - Ventilador
		38532	SENSOR	- Toma Fuerza, Alt. & A.A.
		36095	POLEA	Tensora - Toma Fuerza, Alt. & A.A.
		38535	SENSOR	- Ventilador

**T600**

Cummins ISM Diesel	2008	36091	POLEA	Tensora - A.A.
Caterpillar C15 Diesel	2007	38569	SENSOR	- Ventilador & Alt.
		36091	POLEA	guía - Lisa
		38511	SENSOR	- Ventilador a A.A.
		36093	POLEA	guía - ranurada
Cummins ISM Diesel	2007	36091	POLEA	Tensora - A.A.
Cummins ISX Diesel	2007	38587	SENSOR	- Ventilador & Alt.
Caterpillar C15 Diesel	2006	36091	POLEA	Tensora - Ventilador a A.A.
		36091	POLEA	Tensora - Ventilador & Alt.
		36091	POLEA	guía - Lisa
		38506	SENSOR	- Ventilador & Alt.
		36093	POLEA	guía - ranurada
		38508	SENSOR	- Ventilador a A.A.
Cummins ISM Diesel	2006	36091	POLEA	Tensora - A.A.
Cummins ISX Diesel	2006	38587	SENSOR	- Ventilador & Alt.
Caterpillar C15 Diesel	2005	36091	POLEA	Tensora - Ventilador a A.A.
		36091	POLEA	guía - Lisa
		38506	SENSOR	- Ventilador & Alt.
		38508	SENSOR	- Ventilador a A.A.
		36093	POLEA	guía - ranurada
Cummins ISX Diesel	2005	38587	SENSOR	- Ventilador & Alt.
Caterpillar C10 Diesel	2004	36091	POLEA	guía - Ventilador & Alt.
		36091	POLEA	Tensora - Ventilador, Alt. & Toma Fuerza





Caterpillar C11 Diesel	2004	38590	SENSOR	- Ventilador, Alt. & A.A.
		36093	POLEA	guía - ranurada
Caterpillar C12 Diesel	2004	36091	POLEA	guía - Ventilador & Alt.
		36091	POLEA	Tensora - Ventilador, Alt. & Toma Fuerza
		38506	SENSOR	- Ventilador, Alt. & Toma Fuerza
Caterpillar C13 Diesel	2004	38590	SENSOR	- Ventilador, Alt. & A.A.
		36093	POLEA	guía - ranurada
Caterpillar C15 Diesel	2004	36091	POLEA	Tensora - Ventilador a A.A.
		36091	POLEA	guía - Lisa
		36091	POLEA	Tensora - Ventilador & Alt.
		38506	SENSOR	- Ventilador & Alt.
		36093	POLEA	guía - ranurada
		38508	SENSOR	- Ventilador a A.A.
Cummins ISL Diesel	2004	38516	SENSOR	- Ventilador, B.A. & Alt.
		36093	POLEA	Tensora - Ventilador, B.A. & Alt.
Cummins ISM Diesel	2004	36091	POLEA	Tensora - A.A.
		38521	SENSOR	- Ventilador & Alt.
		38505	SENSOR	- Toma Fuerza & A.A.
Cummins ISX Diesel	2004	38587	SENSOR	- Ventilador & Alt.
Caterpillar C10 Diesel	2003	36091	POLEA	Tensora - Ventilador & Alt.
		36091	POLEA	guía - Ventilador & Alt.
		38506	SENSOR	- Ventilador, Alt. & Toma Fuerza
Caterpillar C11 Diesel	2003	38590	SENSOR	- Ventilador, Alt. & A.A.
		36093	POLEA	guía - ranurada
Caterpillar C12 Diesel	2003	36091	POLEA	Tensora - Ventilador & Alt.
		36091	POLEA	guía - Ventilador & Alt.
		38506	SENSOR	- Ventilador, Alt. & Toma Fuerza
		38506	SENSOR	- Ventilador, Alt. & Toma Fuerza
Cummins ISL Diesel	2003	36093	POLEA	Tensora - Ventilador, B.A. & Alt.
		38516	SENSOR	- Ventilador, B.A. & Alt.
Cummins ISM Diesel	2003	36091	POLEA	Tensora - A.A.
		38521	SENSOR	- Ventilador & Alt.
		38505	SENSOR	- Toma Fuerza & A.A.
Cummins ISX Diesel	2003	36092	POLEA	Tensora - Ventilador
		38532	SENSOR	- Toma Fuerza, Alt. & A.A.
		38535	SENSOR	- Ventilador
		36095	POLEA	Tensora - Toma Fuerza, Alt. & A.A.
Caterpillar C10 Diesel	2002	36091	POLEA	guía - Ventilador & Alt.
		36091	POLEA	Tensora - Ventilador, Alt. & Toma Fuerza
		38506	SENSOR	- Ventilador, Alt. & Toma Fuerza
Caterpillar C12 Diesel	2002	36091	POLEA	guía - Ventilador & Alt.
		36091	POLEA	Tensora - Ventilador, Alt. & Toma Fuerza
		38506	SENSOR	- Ventilador, Alt. & Toma Fuerza
Cummins ISL Diesel	2002	38516	SENSOR	- Ventilador, B.A. & Alt.
		36093	POLEA	Tensora - Ventilador, B.A. & Alt.
Cummins ISM Diesel	2002	38521	SENSOR	- Ventilador & Alt.
Cummins ISX Diesel	2002	36092	POLEA	Tensora - Ventilador
		38532	SENSOR	- Toma Fuerza, Alt. & A.A.
		38535	SENSOR	- Ventilador
		36095	POLEA	Tensora - Toma Fuerza, Alt. & A.A.
Caterpillar C10 Diesel	2001	36091	POLEA	Tensora - Ventilador, Alt. & Toma Fuerza
		36091	POLEA	guía - Ventilador & Alt.
		38506	SENSOR	- Ventilador, Alt. & Toma Fuerza
Caterpillar C12 Diesel	2001	36091	POLEA	Tensora - Ventilador, Alt. & Toma Fuerza
		38506	SENSOR	- Ventilador, Alt. & Toma Fuerza
Cummins ISL Diesel	2001	38516	SENSOR	- Ventilador, B.A. & Alt.
		36093	POLEA	Tensora - Ventilador, B.A. & Alt.
Cummins ISM Diesel	2001	38521	SENSOR	- Ventilador & Alt.
Cummins ISX Diesel	2001	36092	POLEA	Tensora - Ventilador
		38532	SENSOR	- Toma Fuerza, Alt. & A.A.
		38535	SENSOR	- Ventilador
		36095	POLEA	Tensora - Toma Fuerza, Alt. & A.A.
Detroit Diesel 6-Cyl. 11.1 L Diesel	2001	38075	POLEA	Tensora - Toma Fuerza, Alt. & A.A.
		38501	SENSOR	- Toma Fuerza, Alt. & A.A.
Detroit Diesel 6-Cyl. 12.7 L Diesel	2001	38501	SENSOR	- Toma Fuerza, Alt. & A.A.
		38075	POLEA	Tensora - Toma Fuerza, Alt. & A.A.
DETROIT DIESEL SERIE 60	2001	38075	POLEA	Loca
		38501	SENSOR	Tensora - Ventilador, Alt. & Toma Fuerza
Caterpillar C10 Diesel	2000	36091	POLEA	guía - Ventilador & Alt.
		36091	POLEA	- Ventilador, Alt. & Toma Fuerza
		38506	SENSOR	guía - Ventilador & Alt.
Caterpillar C12 Diesel	2000	36091	POLEA	Tensora - Ventilador, Alt. & Toma Fuerza
		36091	POLEA	- Ventilador, Alt. & Toma Fuerza
		38506	SENSOR	Tensora - Ventilador & Alt.
Cummins ISM Diesel	2000	38521	SENSOR	- Ventilador & Alt.
Cummins ISX Diesel	2000	36092	POLEA	Tensora - Ventilador

		38532	SENSOR	- Toma Fuerza, Alt. & A.A.
		38535	SENSOR	- Ventilador
		36095	POLEA	Tensora - Toma Fuerza, Alt. & A.A.
Detroit Diesel 6-Cyl. 11.1 L Diesel	2000	38075	POLEA	Tensora - Toma Fuerza, Alt. & A.A.
		38501	SENSOR	- Toma Fuerza, Alt. & A.A.
Detroit Diesel 6-Cyl. 12.7 L Diesel	2000	38075	POLEA	Tensora - Toma Fuerza, Alt. & A.A.
		38501	SENSOR	- Toma Fuerza, Alt. & A.A.
Caterpillar C10 Diesel	1999	36091	POLEA	Tensora - Ventilador, Alt. & Toma Fuerza
		38506	SENSOR	- Ventilador, Alt. & Toma Fuerza
Caterpillar C12 Diesel	1999	36091	POLEA	Tensora - Ventilador, Alt. & Toma Fuerza
		38506	SENSOR	- Ventilador, Alt. & Toma Fuerza
Cummins ISM Diesel	1999	38521	SENSOR	- Ventilador & Alt.
Cummins ISX Diesel	1999	36092	POLEA	Tensora - Ventilador
		38532	SENSOR	- Toma Fuerza, Alt. & A.A.
		36095	POLEA	Tensora - Toma Fuerza, Alt. & A.A.
		38535	SENSOR	- Ventilador
		36091	POLEA	guía - Ventilador & Alt.
Caterpillar C10 Diesel	1998	36091	POLEA	Tensora - Ventilador, Alt. & Toma Fuerza
		36091	POLEA	- Ventilador, Alt. & Toma Fuerza
		38506	SENSOR	- Ventilador, Alt. & Toma Fuerza
Caterpillar C12 Diesel	1998	36091	POLEA	guía - Ventilador & Alt.
		36091	POLEA	Tensora - Ventilador, Alt. & Toma Fuerza
		38506	SENSOR	- Ventilador, Alt. & Toma Fuerza
Caterpillar C10 Diesel	1997	36091	POLEA	guía - Ventilador & Alt.
		36091	POLEA	Tensora - Ventilador, Alt. & Toma Fuerza
		38506	SENSOR	- Ventilador, Alt. & Toma Fuerza
Caterpillar C12 Diesel	1997	36091	POLEA	Tensora - Ventilador, Alt. & Toma Fuerza
		36091	POLEA	guía - Ventilador & Alt.
		38506	SENSOR	- Ventilador, Alt. & Toma Fuerza
Caterpillar C12 Diesel	1996	36091	POLEA	Tensora - Ventilador, Alt. & Toma Fuerza
		36091	POLEA	guía - Ventilador & Alt.
		38506	SENSOR	Tensora - Ventilador, Alt. & Toma Fuerza

### T800B AEROCAB

CATERPILLAR C10 DIESEL	2000	38505	SENSOR
CATERPILLAR C12 DIESEL	2000	38505	SENSOR
CATERPILLAR C10 DIESEL	1999	38505	SENSOR
CATERPILLAR C12 DIESEL	1999	38505	SENSOR

### T800SH AEROCAB

CATERPILLAR C10 DIESEL	2000	38505	SENSOR
CATERPILLAR C12 DIESEL	2000	38505	SENSOR
CATERPILLAR C10 DIESEL	1999	38505	SENSOR
CATERPILLAR C12 DIESEL	1999	38505	SENSOR

### W900

Caterpillar C15 Diesel	2008	36091	POLEA	guía - Lisa
		36093	POLEA	guía - ranurada
Caterpillar C11 Diesel	2007	38590	SENSOR	- Ventilador, Alt. & A.A.
		36093	POLEA	guía - ranurada
Caterpillar C13 Diesel	2007	38590	SENSOR	- Ventilador, Alt. & A.A.
		36093	POLEA	guía - ranurada
Caterpillar C15 Diesel	2007	38569	SENSOR	- Ventilador & Alt.
		36091	POLEA	guía - Lisa
		36091	POLEA	Tensora - Ventilador a A.A.
		38511	SENSOR	- Ventilador a A.A.
		36093	POLEA	guía - ranurada
Cummins ISX Diesel	2007	38587	SENSOR	- Ventilador & Alt.
Caterpillar C11 Diesel	2006	38590	SENSOR	- Ventilador, Alt. & A.A.
		36093	POLEA	guía - ranurada
Caterpillar C13 Diesel	2006	38590	SENSOR	- Ventilador, Alt. & A.A.
		36093	POLEA	guía - ranurada
Caterpillar C15 Diesel	2006	38569	SENSOR	- Ventilador & Alt.
		36091	POLEA	guía - Lisa
		36091	POLEA	Tensora - Ventilador a A.A.
		38511	SENSOR	- Ventilador a A.A.
		36093	POLEA	guía - ranurada
Cummins ISM Diesel	2006	38622	SENSOR	- Ventilador & Alt.
		36091	POLEA	Tensora - A.A.
		38505	SENSOR	- Toma Fuerza & A.A.
Cummins ISX Diesel	2006	38587	SENSOR	- Ventilador & Alt.
Caterpillar C11 Diesel	2005	38590	SENSOR	- Ventilador, Alt. & A.A.
		36093	POLEA	guía - ranurada
Caterpillar C13 Diesel	2005	38590	SENSOR	- Ventilador, Alt. & A.A.

Caterpillar C13 Diesel	2005	36093	POLEA	guía - ranurada
Caterpillar C15 Diesel	2005	38569	SENSOR	- Ventilador & Alt.
		36091	POLEA	Tensora - Ventilador a A.A.
		36091	POLEA	guía - Lisa
		38511	SENSOR	- Ventilador a A.A.
		36093	POLEA	guía - ranurada
Cummins ISM Diesel	2005	38622	SENSOR	- Ventilador & Alt.
		36091	POLEA	Tensora - A.A.
		38505	SENSOR	- Toma Fuerza & A.A.
Cummins ISX Diesel	2005	38587	SENSOR	- Ventilador & Alt.
Caterpillar C10 Diesel	2004	36091	POLEA	guía - Ventilador & Alt.
Caterpillar C12 Diesel	2004	36091	POLEA	guía - Ventilador & Alt.
Caterpillar C13 Diesel	2004	38590	SENSOR	- Ventilador, Alt. & A.A.
		36093	POLEA	guía - ranurada
Caterpillar C15 Diesel	2004	38569	SENSOR	- Ventilador & Alt.
		36091	POLEA	Tensora - Ventilador a A.A.
		36091	POLEA	guía - Lisa
		38511	SENSOR	- Ventilador a A.A.
		36093	POLEA	guía - ranurada
Cummins ISC Diesel	2004	36093	POLEA	Tensora - Ventilador & Alt.
		38516	SENSOR	- Ventilador & Alt.
Cummins ISM Diesel	2004	36091	POLEA	Tensora - A.A.
		38521	SENSOR	- Ventilador & Alt.
		38505	SENSOR	- Toma Fuerza & A.A.
Cummins ISX Diesel	2004	38587	SENSOR	- Ventilador & Alt.
Caterpillar C10 Diesel	2003	36091	POLEA	guía - Ventilador & Alt.
Caterpillar C12 Diesel	2003	36091	POLEA	guía - Ventilador & Alt.
Cummins ISC Diesel	2003	36093	POLEA	Tensora - Ventilador & Alt.
		38516	SENSOR	- Ventilador & Alt.
Cummins ISM Diesel	2003	36091	POLEA	Tensora - A.A.
		38505	SENSOR	- Toma Fuerza & A.A.
		38521	SENSOR	- Ventilador & Alt.
Cummins ISX Diesel	2003	38587	SENSOR	- Ventilador & Alt.
		36095	POLEA	Tensora - Toma Fuerza, Alt. & A.A.
		36092	POLEA	Tensora - Ventilador
		38532	SENSOR	- Toma Fuerza, Alt. & A.A.
		38535	SENSOR	- Ventilador
Caterpillar C10 Diesel	2002	36091	POLEA	guía - Ventilador & Alt.
Caterpillar C12 Diesel	2002	36091	POLEA	guía - Ventilador & Alt.
Cummins ISM Diesel	2002	38521	SENSOR	- Ventilador & Alt.
Cummins ISX Diesel	2002	36092	POLEA	Tensora - Ventilador
		36095	POLEA	Tensora - Toma Fuerza, Alt. & A.A.
		38532	SENSOR	- Toma Fuerza, Alt. & A.A.
		38535	SENSOR	- Ventilador
Cummins Signature 600 Diesel	2002	36092	POLEA	Tensora - Ventilador
		36095	POLEA	Tensora - Toma Fuerza, Alt. & A.A.
		38532	SENSOR	- Toma Fuerza, Alt. & A.A.
		38535	SENSOR	- Ventilador
Caterpillar C10 Diesel	2001	36091	POLEA	guía - Ventilador & Alt.
Caterpillar C12 Diesel	2001	36091	POLEA	guía - Ventilador & Alt.
Cummins ISX Diesel	2001	36095	POLEA	Tensora - Toma Fuerza, Alt. & A.A.
		36092	POLEA	Tensora - Ventilador
		38532	SENSOR	- Toma Fuerza, Alt. & A.A.
		38535	SENSOR	- Ventilador
Cummins Signature 600 Diesel	2001	36095	POLEA	Tensora - Toma Fuerza, Alt. & A.A.
		36092	POLEA	Tensora - Ventilador
		38532	SENSOR	- Toma Fuerza, Alt. & A.A.
		38535	SENSOR	- Ventilador
Detroit Diesel 6-Cyl. 11.1 L Diesel	2001	38501	SENSOR	- Toma Fuerza, Alt. & A.A.
		38075	POLEA	Tensora - Toma Fuerza, Alt. & A.A.
Detroit Diesel 6-Cyl. 12.7 L Diesel	2001	38501	SENSOR	- Toma Fuerza, Alt. & A.A.
		38075	POLEA	Tensora - Toma Fuerza, Alt. & A.A.
Caterpillar C10 Diesel	2000	36091	POLEA	guía - Ventilador & Alt.
Caterpillar C12 Diesel	2000	36091	POLEA	guía - Ventilador & Alt.
Cummins ISX Diesel	2000	36092	POLEA	Tensora - Ventilador
		36095	POLEA	Tensora - Toma Fuerza, Alt. & A.A.
		38532	SENSOR	- Toma Fuerza, Alt. & A.A.
		38535	SENSOR	- Ventilador
Cummins Signature 600 Diesel	2000	36092	POLEA	Tensora - Ventilador
		36095	POLEA	Tensora - Toma Fuerza, Alt. & A.A.
		38532	SENSOR	- Toma Fuerza, Alt. & A.A.
		38535	SENSOR	- Ventilador
Detroit Diesel 6-Cyl. 11.1 L Diesel	2000	38501	SENSOR	- Toma Fuerza, Alt. & A.A.
		38075	POLEA	Tensora - Toma Fuerza, Alt. & A.A.
Detroit Diesel 6-Cyl. 12.7 L Diesel	2000	38501	SENSOR	- Toma Fuerza, Alt. & A.A.

Caterpillar C10 Diesel	1999	38075	POLEA	Tensora - Toma Fuerza, Alt. & A.A.
Cummins ISX Diesel	1999	36091	POLEA	guía - Ventilador & Alt.
		36092	POLEA	Tensora - Ventilador
		36095	POLEA	Tensora - Toma Fuerza, Alt. & A.A.
		38532	SENSOR	- Toma Fuerza, Alt. & A.A.
		38535	SENSOR	- Ventilador
Caterpillar C10 Diesel	1998	36091	POLEA	guía - Ventilador & Alt.
Caterpillar C10 Diesel	1997	36091	POLEA	guía - Ventilador & Alt.

## MACK

### CL SERIES

Cummins ISX Diesel	2007	38587	SENSOR	- Ventilador & Alt.
Cummins ISX Diesel	2006	38587	SENSOR	- Ventilador & Alt.
Cummins ISX Diesel	2005	38587	SENSOR	- Ventilador & Alt.
Cummins ISX Diesel	2004	38587	SENSOR	- Ventilador & Alt.
Cummins Signature 600 Diesel	2003	36092	POLEA	Tensora - Ventilador
		38535	SENSOR	- Ventilador
		38532	SENSOR	- Toma Fuerza, Alt. & A.A.
		36095	POLEA	Tensora - Toma Fuerza, Alt. & A.A.
Cummins Signature 600 Diesel	2002	36092	POLEA	Tensora - Ventilador
		36095	POLEA	Tensora - Toma Fuerza, Alt. & A.A.
		38532	SENSOR	- Toma Fuerza, Alt. & A.A.
		38535	SENSOR	- Ventilador
Cummins Signature 600 Diesel	2001	36092	POLEA	Tensora - Ventilador
		38532	SENSOR	- Toma Fuerza, Alt. & A.A.
		36095	POLEA	Tensora - Toma Fuerza, Alt. & A.A.
		38535	SENSOR	- Ventilador
Mack 6-Cyl. 12.0 L Diesel	2001	36092	POLEA	Tensora - Ventilador & Alt.
		38523	SENSOR	- Ventilador & Alt.

### CS SERIES

Mack AC Diesel	2003	36092	POLEA	Tensora - Ventilador & Alt.
		38523	SENSOR	- Ventilador & Alt.

### CT SERIES

Mack AI Diesel	2007	38589	SENSOR	- Toma Fuerza, Ventilador, Alt. & A.A.
		36092	POLEA	Tensora
Mack AI Diesel	2006	38589	SENSOR	- Ventilador, Alt. & A.A.
		36092	POLEA	Tensora
Mack AMI Diesel	2006	38589	SENSOR	- Ventilador, Alt. & A.A.
		36092	POLEA	Tensora

### CTP SERIES

Mack MP7 Diesel	2007	38607	SENSOR	- Ventilador
-----------------	------	-------	--------	--------------

### CV SERIES

Mack AI Diesel	2007	38589	SENSOR	- Ventilador, Alt. & A.A.
		36092	POLEA	Tensora - Ventilador
		38523	SENSOR	- Ventilador
Mack AI Diesel	2006	38589	SENSOR	- Ventilador, Alt. & A.A.
		36092	POLEA	Tensora - Ventilador
		38523	SENSOR	- Ventilador
Mack AMI Diesel	2006	36092	POLEA	Tensora - Ventilador
		38523	SENSOR	- Ventilador
MACK AI DIESEL	2005	38523	SENSOR	Vent.
Mack AMI Diesel	2005	38589	SENSOR	- Ventilador, Alt. & A.A.
		36092	POLEA	Tensora - Ventilador
		38523	SENSOR	- Ventilador
Mack AMI Diesel	2004	38589	SENSOR	- Ventilador, Alt. & A.A.
		36092	POLEA	Tensora - Ventilador & Alt.
		36092	POLEA	Tensora - Ventilador
		38523	SENSOR	- Ventilador
Mack AI Diesel	2003	36092	POLEA	Tensora - Ventilador & Alt.
		38523	SENSOR	- Ventilador & Alt.
Mack AMI Diesel	2003	36092	POLEA	Tensora - Ventilador & Alt.
		38523	SENSOR	- Ventilador & Alt.
Mack 6-Cyl. 12.0 L Diesel	2002	36092	POLEA	Tensora - Ventilador & Alt.



Mack 6-Cyl. 12.0 L Diesel	2002	38523	SENSOR	- Ventilador & Alt.
Mack 6-Cyl. 12.0 L Diesel	2001	36092	POLEA	Tensora - Ventilador & Alt.
		38523	SENSOR	- Ventilador & Alt.



		38523	SENSOR	- Ventilador
--	--	-------	--------	--------------

### CX SERIES

Mack AC Diesel	2006	38617	SENSOR	- Ventilador & Alt.
		38589	SENSOR	- Ventilador, Alt. & A.A.
		36092	POLEA	Tensora - Ventilador
Mack AC Diesel	2005	38611	SENSOR	- Ventilador
		38589	SENSOR	- Ventilador, Alt. & A.A.
		36092	POLEA	Tensora - Ventilador
Mack AC Diesel	2004	38611	SENSOR	- Ventilador
		38589	SENSOR	- Ventilador, Alt. & A.A.
		36092	POLEA	Tensora - Ventilador
Mack AC Diesel	2003	38611	SENSOR	- Ventilador
		38589	SENSOR	- Ventilador, Alt. & A.A.
		36092	POLEA	Tensora - Ventilador
Mack 6-Cyl. 12.0 L Diesel	2002	36092	POLEA	Tensora - Ventilador & Alt.
		38523	SENSOR	- Ventilador & Alt.
Mack 6-Cyl. 12.0 L Diesel	2001	36092	POLEA	Tensora - Ventilador & Alt.
		38523	SENSOR	- Ventilador & Alt.

### CXN SERIES

Mack AC Diesel	2007	38589	SENSOR	- Ventilador, Alt. & A.A.
		36092	POLEA	Tensora - Ventilador
		38523	SENSOR	- Ventilador
Mack AC Diesel	2006	38589	SENSOR	- Ventilador, Alt. & A.A.
		36092	POLEA	Tensora - Ventilador
		38523	SENSOR	- Ventilador

### CXP SERIES

Mack MP7 Diesel	2007	38607	SENSOR	- Ventilador
Mack MP7 Diesel	2006	38589	SENSOR	- Ventilador & Toma Fuerza
		38523	SENSOR	- Alt. & A.A.

### CH SERIES

Mack AC Diesel	2006	38589	SENSOR	- Toma Fuerza, Ventilador, Alt. & A.A.
		36092	POLEA	Tensora - Ventilador
		38523	SENSOR	- Ventilador
Mack AC Diesel	2005	38589	SENSOR	- Toma Fuerza, Ventilador, Alt. & A.A.
		36092	POLEA	Tensora - Ventilador
		38523	SENSOR	- Ventilador
Mack AC Diesel	2004	38589	SENSOR	- Toma Fuerza, Ventilador, Alt. & A.A.
		36092	POLEA	Tensora - Ventilador
		38523	SENSOR	- Ventilador
Cummins Signature 600 Diesel	2003	36092	POLEA	Tensora - Ventilador
		38532	SENSOR	- Toma Fuerza, Alt. & A.A.
		38535	SENSOR	- Ventilador
		36095	POLEA	Tensora - Toma Fuerza, Alt. & A.A.
Mack AC Diesel	2003	38589	SENSOR	- Toma Fuerza, Ventilador, Alt. & A.A.
		36092	POLEA	Tensora - Ventilador
		38523	SENSOR	- Ventilador
Cummins Signature 600 Diesel	2002	36092	POLEA	Tensora - Ventilador
		38532	SENSOR	- Toma Fuerza, Alt. & A.A.
		36095	POLEA	Tensora - Toma Fuerza, Alt. & A.A.
		38535	SENSOR	- Ventilador
Mack 6-Cyl. 12.0 L Diesel	2002	36092	POLEA	Tensora - Ventilador & Alt.
		38523	SENSOR	- Ventilador & Alt.
Cummins Signature 600 Diesel	2001	36092	POLEA	Tensora - Ventilador
		36095	POLEA	Tensora - Toma Fuerza, Alt. & A.A.
		38535	SENSOR	- Ventilador
		38532	SENSOR	- Toma Fuerza, Alt. & A.A.
Mack 6-Cyl. 12.0 L Diesel	2001	36092	POLEA	Tensora - Ventilador & Alt.
		38523	SENSOR	- Ventilador & Alt.

### CHN SERIES

Mack AC Diesel	2007	38589	SENSOR	- Toma Fuerza, Ventilador, Alt. & A.A.
		36092	POLEA	Tensora - Ventilador
		38523	SENSOR	- Ventilador
Mack AC Diesel	2006	38589	SENSOR	- Toma Fuerza, Ventilador, Alt. & A.A.
		36092	POLEA	Tensora - Ventilador

### DM SERIES

Mack 6-Cyl. 12.0 L Diesel	2001	36092	POLEA	Tensora - Ventilador & Alt.
		38523	SENSOR	- Ventilador & Alt.

### LE SERIES

Mack AI Diesel	2006	38599	SENSOR	- Ventilador, Alt. & A.A.
Mack AI Diesel	2005	38599	SENSOR	- Ventilador, Alt. & A.A.
		36092	POLEA	Tensora - Ventilador & Alt.
		38523	SENSOR	- Ventilador & Alt.
Mack AI Diesel	2004	38599	SENSOR	- Ventilador, Alt. & A.A.
		36092	POLEA	Tensora - Ventilador & Alt.
		38523	SENSOR	- Ventilador & Alt.
Mack AI Diesel	2003	36092	POLEA	Tensora - Ventilador & Alt.
		38523	SENSOR	- Ventilador & Alt.

### MR SERIES

Mack AMI Diesel	2007	38599	SENSOR	- Ventilador & A.A.
Mack AI Diesel	2006	38599	SENSOR	- Ventilador, Alt. & A.A.
Mack AMI Diesel	2006	38599	SENSOR	- Ventilador, Alt. & A.A.
Mack AI Diesel	2005	38599	SENSOR	- Ventilador, Alt. & A.A.
Mack AMI Diesel	2005	38589	SENSOR	- B.A., Alt. & A.A.
		38599	SENSOR	- Ventilador
Mack AMI Diesel	2004	38599	SENSOR	- Ventilador
		38589	SENSOR	- B.A., Alt. & A.A.
Mack AMI Diesel	2003	38589	SENSOR	- B.A., Alt. & A.A.
		38599	SENSOR	- Ventilador
Mack 6-Cyl. 12.0 L Diesel	2002	36092	POLEA	Tensora - Ventilador & Alt.
		38523	SENSOR	- Ventilador & Alt.
Mack 6-Cyl. 12.0 L Diesel	2001	36092	POLEA	Tensora - Ventilador & Alt.
		38523	SENSOR	- Ventilador & Alt.

### RD SERIES

Mack E7 Diesel	2003	36092	POLEA	Tensora - Ventilador
		38523	SENSOR	- Ventilador
Mack 6-Cyl. 12.0 L Diesel	2002	36092	POLEA	Tensora - Ventilador & Alt.
		38523	SENSOR	- Ventilador & Alt.
Mack 6-Cyl. 12.0 L Diesel	2001	36092	POLEA	Tensora - Ventilador & Alt.
		38523	SENSOR	- Ventilador & Alt.

## PETERBILT

### 320

Caterpillar C7 Diesel	2007	36096	POLEA	guía
		36091	POLEA	guía - Lisa
Cummins ISM Diesel	2007	38505	SENSOR	- A.A.
		36091	POLEA	Tensora - A.A.
		38521	SENSOR	- Ventilador & Alt.
Caterpillar C7 Diesel	2006	36096	POLEA	guía
		36091	POLEA	guía - Lisa
Caterpillar C7 Diesel	2005	36091	POLEA	guía - Lisa
		36096	POLEA	guía
Caterpillar C7 Diesel	2004	36091	POLEA	guía - Lisa
		36096	POLEA	guía
Cummins ISC Diesel	1997	38507	SENSOR	- Ventilador & Alt.
Cummins C Series 8.3 L Diesel	1996	38507	SENSOR	- Ventilador & Alt.

### 330

Caterpillar C7 Diesel	2007	38586	SENSOR	- Ventilador, Alt. & A.A.
		36096	POLEA	guía
		36091	POLEA	guía - Lisa
Caterpillar C7 Diesel	2005	38586	SENSOR	- Ventilador, Alt. & A.A.
		36091	POLEA	guía - Lisa
		36096	POLEA	guía
Cummins ISC Diesel	2005	36093	POLEA	Tensora - Ventilador, Alt. & Toma Fuerza
		38516	SENSOR	- Ventilador, Alt. & Toma Fuerza

Caterpillar C7 Diesel	2004	38586 36091 36096	SENSOR POLEA POLEA	- Ventilador, Alt. & A.A. guía - Lisa
Cummins ISC Diesel	2004	36093 38516	POLEA SENSOR	Tensora - Ventilador, Alt. & Toma Fuerza - Ventilador, Alt. & Toma Fuerza
Caterpillar 3126 Diesel	2003	36091 38511	POLEA SENSOR	Tensora - Ventilador, Alt. & A.A. - Ventilador, Alt. & A.A.
Cummins ISC Diesel	2003	36093 38516	POLEA SENSOR	Tensora - Ventilador, Alt. & Toma Fuerza - Ventilador, Alt. & Toma Fuerza
Caterpillar 3126 Diesel	2002	38511 36091	SENSOR POLEA	- Ventilador, Alt. & A.A. Tensora - Ventilador, Alt. & A.A.
Cummins ISC Diesel	2002	36093 38516	POLEA SENSOR	Tensora - Ventilador, Alt. & Toma Fuerza - Ventilador, Alt. & Toma Fuerza
Caterpillar 3126 Diesel	2001	38511 36091	SENSOR POLEA	- Ventilador, Alt. & A.A. Tensora - Ventilador, Alt. & A.A.
Cummins ISC Diesel	2001	36093 38516	POLEA SENSOR	Tensora - Ventilador, Alt. & Toma Fuerza - Ventilador, Alt. & Toma Fuerza
Caterpillar 3126 Diesel	2000	38511 36091	SENSOR POLEA	- Ventilador, Alt. & A.A. Tensora - Ventilador, Alt. & A.A.
Cummins ISB Diesel	2000	38525	SENSOR	- Ventilador, Alt. & Toma Fuerza
Cummins ISC Diesel	2000	36093 38516	POLEA SENSOR	Tensora - Ventilador, Alt. & Toma Fuerza - Ventilador, Alt. & Toma Fuerza
Caterpillar 3126 Diesel	1999	38511 36091	SENSOR POLEA	- Ventilador, Alt. & A.A. Tensora - Ventilador, Alt. & A.A.
Cummins ISC Diesel	1999	36093 38516	POLEA SENSOR	Tensora - Ventilador, Alt. & Toma Fuerza - Ventilador, Alt. & Toma Fuerza
Caterpillar 3116 Diesel	1998	38507	SENSOR	- Ventilador & Alt.
Caterpillar 3126 Diesel	1998	36091 38511	POLEA SENSOR	Tensora - Ventilador, Alt. & A.A. - Ventilador, Alt. & A.A.
Caterpillar 3116 Diesel	1997	38507	SENSOR	- Ventilador & Alt.
Caterpillar 3126 Diesel	1997	38507	SENSOR	- Ventilador & Alt.
Caterpillar 3116 Diesel	1996	38507	SENSOR	- Ventilador & Alt.
Caterpillar 3126 Diesel	1996	38507	SENSOR	- Ventilador & Alt.
Caterpillar 3116 Diesel	1995	38507	SENSOR	- Ventilador & Alt.
Caterpillar 3126 Diesel	1995	38507	SENSOR	- Ventilador & Alt.

**335**

Caterpillar C7 Diesel	2007	38586 36091 36096	SENSOR POLEA POLEA	- Ventilador, Alt. & A.A. guía - Lisa
Caterpillar C7 Diesel	2006	38586 36091 36096	SENSOR POLEA POLEA	- Ventilador, Alt. & A.A. guía - Lisa
Cummins ISC Diesel	2006	36093 38516	POLEA SENSOR	Tensora - Ventilador, Alt. & Toma Fuerza - Ventilador, Alt. & Toma Fuerza
Caterpillar C7 Diesel	2005	38586 36091 36096	SENSOR POLEA POLEA	- Ventilador, Alt. & A.A. guía - Lisa
Cummins ISC Diesel	2005	36093 38516	POLEA SENSOR	Tensora - Ventilador, Alt. & Toma Fuerza - Ventilador, Alt. & Toma Fuerza

**357**

Caterpillar C11 Diesel	2007	38590 36093	SENSOR POLEA	- Ventilador, Alt. & A.A. guía - ranurada
Caterpillar C13 Diesel	2007	38590 36093	SENSOR POLEA	- Ventilador, Alt. & A.A. guía - ranurada
Caterpillar C15 Diesel	2007	36091 36091 38511 36093	POLEA POLEA SENSOR POLEA	Tensora - Ventilador a A.A. guía - Lisa - Ventilador a A.A. guía - ranurada
Cummins ISM Diesel	2007	38622 36091 38505	SENSOR POLEA SENSOR	- Ventilador & Alt. Tensora - A.A. - Toma Fuerza & A.A.
Caterpillar C11 Diesel	2006	38590 36093	SENSOR POLEA	- Ventilador, Alt. & A.A. guía - ranurada
Caterpillar C13 Diesel	2006	38590 36093	SENSOR POLEA	- Ventilador, Alt. & A.A. guía - ranurada
Caterpillar C15 Diesel	2006	38569 36091 36091 36093	SENSOR POLEA POLEA POLEA	- Ventilador & Alt. Tensora - Ventilador a A.A. guía - Lisa guía - ranurada
Cummins ISM Diesel	2006	38511 38622 36091	SENSOR SENSOR POLEA	- Ventilador a A.A. - Ventilador & Alt. Tensora - A.A.

Cummins ISX Diesel	2006	38505	SENSOR	- Toma Fuerza & A.A.
Caterpillar C11 Diesel	2005	38587 36093	SENSOR POLEA	- Ventilador & Alt. guía - ranurada
Caterpillar C13 Diesel	2005	38590 36093	SENSOR POLEA	- Ventilador, Alt. & A.A. guía - ranurada
Caterpillar C15 Diesel	2005	38569 36091 36091 36093	SENSOR POLEA POLEA POLEA	- Ventilador & Alt. guía - Lisa Tensora - Ventilador a A.A. guía - ranurada
Cummins ISM Diesel	2005	38511 38622 36091	SENSOR SENSOR POLEA	- Ventilador a A.A. - Ventilador & Alt. Tensora - A.A.
Caterpillar C10 Diesel	2004	38505 36091 38506	SENSOR POLEA SENSOR	- Toma Fuerza & A.A. Tensora - Ventilador & Alt. - Ventilador & Alt.
Caterpillar C12 Diesel	2004	36091 38506	POLEA SENSOR	Tensora - Ventilador & Alt. - Ventilador & Alt.
Caterpillar C15 Diesel	2004	36091 38506 36091 36093	POLEA SENSOR POLEA POLEA	- Ventilador & Alt. Tensora - Ventilador a A.A. guía - ranurada
Cummins ISM Diesel	2004	38505 36091	SENSOR POLEA	- Toma Fuerza & A.A. Tensora - A.A.
Caterpillar C10 Diesel	2003	38506 36091	SENSOR POLEA	- Ventilador & Alt. Tensora - Ventilador & Alt.
Caterpillar C12 Diesel	2003	36091 38506	POLEA SENSOR	- Ventilador & Alt. Tensora - Ventilador & Alt.
Cummins ISM Diesel	2003	36091 38505	POLEA SENSOR	Tensora - A.A. - Toma Fuerza & A.A.
Caterpillar C10 Diesel	2002	38521 36091	SENSOR POLEA	- Ventilador & Alt. Tensora - Ventilador & Alt.
Caterpillar C12 Diesel	2002	38506 36091	SENSOR POLEA	- Ventilador & Alt. Tensora - Ventilador & Alt.
Caterpillar C10 Diesel	2001	38506 36091 38506	SENSOR POLEA SENSOR	- Ventilador & Alt. Tensora - Ventilador & Alt. - Ventilador & Alt.
Cummins ISC Diesel	2001	36091	POLEA	Tensora - A.A.
Cummins ISM Diesel	2001	38505 38521	SENSOR SENSOR	- Toma Fuerza & A.A. - Ventilador & Alt.
Caterpillar C10 Diesel	2000	36091 38506	POLEA SENSOR	Tensora - Ventilador & Alt. - Ventilador & Alt.
Caterpillar C12 Diesel	2000	36091 38506	POLEA SENSOR	Tensora - Ventilador & Alt. - Ventilador & Alt.
Caterpillar 3126 Diesel	1999	38507	SENSOR	- Ventilador & Alt.
Caterpillar C10 Diesel	1999	36091 38506	POLEA SENSOR	Tensora - Ventilador & Alt. - Ventilador & Alt.
Caterpillar C12 Diesel	1999	36091 38506	POLEA SENSOR	Tensora - Ventilador & Alt. - Ventilador & Alt.
Caterpillar 3126 Diesel	1998	38507	SENSOR	- Ventilador & Alt.
Caterpillar C10 Diesel	1998	36091 38506	POLEA SENSOR	Tensora - Ventilador & Alt. - Ventilador & Alt.
Caterpillar C12 Diesel	1998	36091 38506	POLEA SENSOR	Tensora - Ventilador & Alt. - Ventilador & Alt.
Caterpillar C10 Diesel	1997	36091 38506	POLEA SENSOR	Tensora - Ventilador & Alt. - Ventilador & Alt.
Caterpillar C12 Diesel	1997	36091 38506	POLEA SENSOR	Tensora - Ventilador & Alt. - Ventilador & Alt.

**362**

Caterpillar C10 Diesel	1998	36091 38506	POLEA SENSOR	Tensora - Ventilador & Alt. - Ventilador & Alt.
Caterpillar C12 Diesel	1998	36091 38506	POLEA SENSOR	Tensora - Ventilador & Alt. - Ventilador & Alt.
Caterpillar C10 Diesel	1997	36091 38506	POLEA SENSOR	Tensora - Ventilador & Alt. - Ventilador & Alt.
Caterpillar C12 Diesel	1997	36091 38506	POLEA SENSOR	Tensora - Ventilador & Alt. - Ventilador & Alt.
Caterpillar C10 Diesel	1996	36091 38506	POLEA SENSOR	Tensora - Ventilador & Alt. - Ventilador & Alt.
Caterpillar C12 Diesel	1996	36091 38506	POLEA SENSOR	Tensora - Ventilador & Alt. - Ventilador & Alt.



Caterpillar C15 Diesel	2004	38569	SENSOR	- Ventilador & Alt.
		38511	SENSOR	- Ventilador a A.A.
		36091	POLEA	Tensora - Ventilador a A.A.
		36091	POLEA	guía - Lisa
		36093	POLEA	guía - ranurada
Cummins ISX Diesel	2004	38587	SENSOR	- Ventilador & Alt.
Caterpillar C10 Diesel	2003	36091	POLEA	Tensora - Ventilador & Alt.
		38506	SENSOR	- Ventilador & Alt.
Caterpillar C12 Diesel	2003	36091	POLEA	Tensora - Ventilador & Alt.
		38506	SENSOR	- Ventilador & Alt.
Cummins ISX Diesel	2003	38587	SENSOR	- Ventilador & Alt.
Caterpillar C10 Diesel	2002	36091	POLEA	Tensora - Ventilador & Alt.
		38506	SENSOR	- Ventilador & Alt.
Caterpillar C12 Diesel	2002	36091	POLEA	Tensora - Ventilador & Alt.
		38506	SENSOR	- Ventilador & Alt.
Cummins ISX Diesel	2002	36092	POLEA	Tensora - Ventilador
		38532	SENSOR	- Toma Fuerza, Alt. & A.A.
		38535	SENSOR	- Ventilador
		36095	POLEA	Tensora - Toma Fuerza, Alt. & A.A.
Cummins Signature 600 Diesel	2002	36092	POLEA	Tensora - Ventilador
		36095	POLEA	Tensora - Toma Fuerza, Alt. & A.A.
		38532	SENSOR	- Toma Fuerza, Alt. & A.A.
		38535	SENSOR	- Ventilador
Caterpillar C10 Diesel	2001	38514	SENSOR	- Ventilador & Alt.
Caterpillar C12 Diesel	2001	38514	SENSOR	- Ventilador & Alt.
Cummins ISX Diesel	2001	36092	POLEA	Tensora - Ventilador
		38532	SENSOR	- Toma Fuerza, Alt. & A.A.
		36095	POLEA	Tensora - Toma Fuerza, Alt. & A.A.
Cummins Signature 600 Diesel	2001	38532	SENSOR	- Ventilador
		38535	SENSOR	- Ventilador
		36095	POLEA	Tensora - Toma Fuerza, Alt. & A.A.
Detroit Diesel 6-Cyl. 11.1 L Diesel	2001	38075	POLEA	Tensora - Toma Fuerza, Alt. & A.A.
		38501	SENSOR	- Toma Fuerza, Alt. & A.A.
Detroit Diesel 6-Cyl. 12.7 L Diesel	2001	38501	SENSOR	- Toma Fuerza, Alt. & A.A.
		38075	POLEA	Tensora - Toma Fuerza, Alt. & A.A.
Caterpillar C10 Diesel	2000	36091	POLEA	Tensora
		38514	SENSOR	- Ventilador & Alt.
Caterpillar C12 Diesel	2000	36091	POLEA	Tensora
		38514	SENSOR	- Ventilador & Alt.
Cummins ISX Diesel	2000	36092	POLEA	Tensora - Ventilador
		36095	POLEA	Tensora - Toma Fuerza, Alt. & A.A.
		38532	SENSOR	- Toma Fuerza, Alt. & A.A.
		38535	SENSOR	- Ventilador
Cummins Signature 600 Diesel	2000	36092	POLEA	Tensora - Ventilador
		38535	SENSOR	- Ventilador
		38532	SENSOR	- Toma Fuerza, Alt. & A.A.
		36095	POLEA	Tensora - Toma Fuerza, Alt. & A.A.
Detroit Diesel 6-Cyl. 11.1 L Diesel	2000	38075	POLEA	Tensora - Toma Fuerza, Alt. & A.A.
		38501	SENSOR	- Toma Fuerza, Alt. & A.A.
Detroit Diesel 6-Cyl. 12.7 L Diesel	2000	38075	POLEA	Tensora - Toma Fuerza, Alt. & A.A.
		38501	SENSOR	- Toma Fuerza, Alt. & A.A.
Cummins ISX Diesel	1998	36092	POLEA	Tensora - Ventilador
		36095	POLEA	Tensora - Toma Fuerza, Alt. & A.A.
		38532	SENSOR	- Toma Fuerza, Alt. & A.A.
		38535	SENSOR	- Ventilador

Caterpillar C10 Diesel	2003	36091	POLEA	Tensora - A.A.
		38521	SENSOR	- Ventilador & Alt.
		36091	POLEA	Tensora - Ventilador & Alt.
		38506	SENSOR	- Ventilador & Alt.
Caterpillar C12 Diesel	2003	36091	POLEA	Tensora - Ventilador & Alt.
		38506	SENSOR	- Ventilador & Alt.
Cummins ISM Diesel	2003	38505	SENSOR	- Toma Fuerza & A.A.
		36091	POLEA	Tensora - A.A.
		38521	SENSOR	- Ventilador & Alt.
Caterpillar C10 Diesel	2002	36091	POLEA	Tensora - Ventilador & Alt.
		38506	SENSOR	- Ventilador & Alt.
Caterpillar C12 Diesel	2002	36091	POLEA	Tensora - Ventilador & Alt.
		38506	SENSOR	- Ventilador & Alt.
Cummins ISM Diesel	2002	38505	SENSOR	- Toma Fuerza & A.A.
		36091	POLEA	Tensora - A.A.
		38521	SENSOR	- Ventilador & Alt.
Caterpillar C10 Diesel	2001	36091	POLEA	Tensora - Ventilador & Alt.
		38506	SENSOR	- Ventilador & Alt.
Caterpillar C12 Diesel	2001	36091	POLEA	Tensora - Ventilador & Alt.
		38506	SENSOR	- Ventilador & Alt.
Caterpillar C10 Diesel	2000	36091	POLEA	Tensora - Ventilador & Alt.
		38506	SENSOR	- Ventilador & Alt.
Caterpillar C12 Diesel	2000	36091	POLEA	Tensora - Ventilador & Alt.
		38506	SENSOR	- Ventilador & Alt.
Caterpillar C10 Diesel	1999	36091	POLEA	Tensora - Ventilador & Alt.
		38506	SENSOR	- Ventilador & Alt.
Caterpillar C12 Diesel	1999	36091	POLEA	Tensora - Ventilador & Alt.
		38506	SENSOR	- Ventilador & Alt.
Caterpillar C10 Diesel	1998	36091	POLEA	Tensora - Ventilador & Alt.
		38506	SENSOR	- Ventilador & Alt.
Caterpillar C12 Diesel	1998	36091	POLEA	Tensora - Ventilador & Alt.
		38506	SENSOR	- Ventilador & Alt.
Caterpillar C10 Diesel	1997	36091	POLEA	Tensora - Ventilador & Alt.
		38506	SENSOR	- Ventilador & Alt.
Caterpillar C12 Diesel	1997	36091	POLEA	Tensora - Ventilador & Alt.
		38506	SENSOR	- Ventilador & Alt.
Caterpillar C10 Diesel	1996	36091	POLEA	Tensora - Ventilador & Alt.
		38506	SENSOR	- Ventilador & Alt.

**386**

Cummins ISX Diesel	2008	38587	SENSOR	- Ventilador & Alt.
Caterpillar C13 Diesel	2007	38590	SENSOR	- Ventilador, Alt. & A.A.
		36093	POLEA	guía - ranurada
Caterpillar C15 Diesel	2007	36091	POLEA	guía - Lisa
		36093	POLEA	guía - ranurada
		38511	SENSOR	- Ventilador a A.A.
Caterpillar C15 Diesel	2006	38511	SENSOR	- Ventilador a A.A.
		36091	POLEA	guía - Lisa
		36093	POLEA	guía - ranurada

**387**

Caterpillar C15 Diesel	2007	38569	SENSOR	- Ventilador & Alt.
		36091	POLEA	guía - Lisa
		36093	POLEA	guía - ranurada
		38511	SENSOR	- Ventilador a A.A.
		36091	POLEA	Tensora - Ventilador a A.A.
Caterpillar C11 Diesel	2006	36093	POLEA	guía - ranurada
Caterpillar C13 Diesel	2006	36093	POLEA	guía - ranurada
Caterpillar C15 Diesel	2006	38569	SENSOR	- Ventilador & Alt.
		38511	SENSOR	- Ventilador a A.A.
		36093	POLEA	guía - ranurada
		36091	POLEA	guía - Lisa
		36091	POLEA	Tensora - Ventilador a A.A.
Cummins ISX Diesel	2006	38587	SENSOR	- Ventilador & Alt.
Caterpillar C13 Diesel	2005	38590	SENSOR	- Ventilador, Alt. & A.A.
		36093	POLEA	guía - ranurada
Caterpillar C15 Diesel	2005	38569	SENSOR	- Ventilador & Alt.
		38511	SENSOR	- Ventilador a A.A.
		36093	POLEA	guía - ranurada
		36091	POLEA	Tensora - Ventilador a A.A.
		36091	POLEA	guía - Lisa
Cummins ISX Diesel	2005	38587	SENSOR	- Ventilador & Alt.
Caterpillar C13 Diesel	2004	38590	SENSOR	- Ventilador, Alt. & A.A.
		36093	POLEA	guía - ranurada

**385**

Caterpillar C11 Diesel	2007	36093	POLEA	guía - ranurada
Caterpillar C13 Diesel	2007	36093	POLEA	guía - ranurada
Caterpillar C11 Diesel	2006	36093	POLEA	guía - ranurada
Caterpillar C13 Diesel	2006	38590	SENSOR	- Ventilador, Alt. & A.A.
		36093	POLEA	guía - ranurada
Caterpillar C11 Diesel	2005	36093	POLEA	guía - ranurada
Caterpillar C13 Diesel	2005	38590	SENSOR	- Ventilador, Alt. & A.A.
		36093	POLEA	guía - ranurada
Cummins ISM Diesel	2005	38622	SENSOR	- Ventilador & Alt.
		36091	POLEA	Tensora - A.A.
		38505	SENSOR	- Toma Fuerza & A.A.
Caterpillar C10 Diesel	2004	36091	POLEA	Tensora - Ventilador & Alt.
		38506	SENSOR	- Ventilador & Alt.
Caterpillar C12 Diesel	2004	36091	POLEA	Tensora - Ventilador & Alt.
		38506	SENSOR	- Ventilador & Alt.
Cummins ISM Diesel	2004	38505	SENSOR	- Toma Fuerza & A.A.



Caterpillar C15 Diesel	2004	38569 36091 36091 38511 36093	SENSOR POLEA POLEA SENSOR POLEA	- Ventilador & Alt. guía - Lisa Tensora - Ventilador a A.A. - Ventilador a A.A. guía - ranurada
Cummins ISX Diesel	2004	38587	SENSOR	- Ventilador & Alt.
Caterpillar C15 Diesel	2003	36091 36091 38506 38508	POLEA POLEA SENSOR SENSOR	Tensora - Ventilador a A.A. Tensora - Ventilador & Alt. - Ventilador & Alt. - Ventilador a A.A.
Caterpillar C16 Diesel	2003	36091 36091 38506 38508	POLEA POLEA SENSOR SENSOR	Tensora - Ventilador a A.A. Tensora - Ventilador & Alt. - Ventilador & Alt. - Ventilador a A.A.
Caterpillar C10 Diesel	2002	36091 38506 36091	POLEA SENSOR POLEA	Tensora - Ventilador & Alt. - Ventilador & Alt. Tensora - Ventilador & Alt.
Caterpillar C12 Diesel	2002	36091 38506	POLEA SENSOR	Tensora - Ventilador & Alt. - Ventilador & Alt.
Caterpillar C15 Diesel	2002	36091 36091 38506 38508	POLEA POLEA SENSOR SENSOR	Tensora - Ventilador & Alt. Tensora - Ventilador a A.A. - Ventilador & Alt. - Ventilador a A.A.
Caterpillar C16 Diesel	2002	36091 36091 38506 38508	POLEA POLEA SENSOR SENSOR	Tensora - Ventilador & Alt. Tensora - Ventilador a A.A. - Ventilador & Alt. - Ventilador a A.A.
Cummins ISX Diesel	2002	36092 38532 36095 38535	POLEA SENSOR POLEA SENSOR	Tensora - Ventilador - Toma Fuerza, Alt. & A.A. Tensora - Toma Fuerza, Alt. & A.A. - Ventilador
Cummins Signature 600 Diesel	2002	36092 38532 36095 38535	POLEA SENSOR POLEA SENSOR	Tensora - Ventilador - Toma Fuerza, Alt. & A.A. Tensora - Toma Fuerza, Alt. & A.A. - Ventilador
Caterpillar C10 Diesel	2001	36091 36091 38506	POLEA POLEA SENSOR	guía - Ventilador & Alt. Tensora - Ventilador & Alt. - Ventilador & Alt.
Caterpillar C12 Diesel	2001	36091 36091 38506	POLEA POLEA SENSOR	Tensora - Ventilador & Alt. - Ventilador & Alt.
Caterpillar C15 Diesel	2001	36091 36091 38506 38508	POLEA POLEA SENSOR SENSOR	Tensora - Ventilador a A.A. Tensora - Ventilador & Alt. - Ventilador & Alt. - Ventilador a A.A.
Caterpillar C16 Diesel	2001	36091 36091 38506 38508	POLEA POLEA SENSOR SENSOR	Tensora - Ventilador & Alt. Tensora - Ventilador a A.A. - Ventilador & Alt. - Ventilador a A.A.
Cummins ISX Diesel	2001	36092 36095 38535 38532	POLEA POLEA SENSOR SENSOR	Tensora - Ventilador Tensora - Toma Fuerza, Alt. & A.A. - Ventilador - Toma Fuerza, Alt. & A.A.
Cummins Signature 600 Diesel	2001	36092 38532 38535 36095	POLEA SENSOR SENSOR POLEA	Tensora - Ventilador - Toma Fuerza, Alt. & A.A. - Ventilador Tensora - Toma Fuerza, Alt. & A.A.
Caterpillar C10 Diesel	2000	36091 36091 38506	POLEA POLEA SENSOR	Tensora - Ventilador & Alt. guía - Ventilador & Alt. - Ventilador & Alt.
Caterpillar C12 Diesel	2000	36091 36091 38506	POLEA POLEA SENSOR	Tensora - Ventilador & Alt. guía - Ventilador & Alt. - Ventilador & Alt.
Cummins ISM Diesel	2000	36091 38505	POLEA SENSOR	Tensora - A.A. - Toma Fuerza & A.A.
		38521	SENSOR	- Ventilador, Alt. & Toma Fuerza



## STERLING

### ACTERRA

Cummins ISC Diesel	2008	36093 38516	POLEA SENSOR	Tensora - Ventilador, B.A. & Alt. - Ventilador, B.A. & Alt.
Caterpillar C7 Diesel	2007	36091 36096	POLEA POLEA	guía - Lisa guía
Cummins ISC Diesel	2007	36093 38516	POLEA SENSOR	Tensora - Ventilador, B.A. & Alt. - Ventilador, B.A. & Alt.
Mercedes-Benz MBE 900 Diesel	2007	38567	SENSOR	
Caterpillar C13 Diesel	2006	38590 38590 36093	SENSOR SENSOR POLEA	- Ventilador & Alt. - Ventilador, Alt. & A.A. guía - ranurada
Caterpillar C7 Diesel	2006	36091 36096	POLEA POLEA	guía - Lisa guía
Cummins ISC Diesel	2006	36093 38516	POLEA SENSOR	Tensora - Ventilador, B.A. & Alt. - Ventilador, B.A. & Alt.
Mercedes-Benz MBE 900 Diesel	2006	38567	SENSOR	
Caterpillar C7 Diesel	2005	36091 36096	POLEA POLEA	guía - Lisa guía
Cummins ISC Diesel	2005	36093 38516	POLEA SENSOR	Tensora - Ventilador, B.A. & Alt. - Ventilador, B.A. & Alt.
Mercedes-Benz MBE 900 Diesel	2005	38567	SENSOR	
Caterpillar 3126 Diesel	2004	36096 36091 38511	POLEA POLEA SENSOR	guía Tensora - Ventilador, Alt. & A.A. - Ventilador, Alt. & A.A.
Caterpillar C13 Diesel	2004	36093	POLEA	guía - ranurada
Caterpillar C7 Diesel	2004	36091 36096	POLEA POLEA	guía - Lisa guía
Mercedes-Benz MBE 900 Diesel	2004	38511 38511	SENSOR SENSOR	Tensor, Vent., Alt. & A.A. - Ventilador, Alt. & A.A.
Caterpillar 3126 Diesel	2003	38511 38511 36096	SENSOR SENSOR POLEA	- Ventilador, Alt. & A.A. Vent., Alt., C/A guía
Mercedes-Benz MBE 900 Diesel	2003	36091 38567	POLEA SENSOR	Tensora Tensora - Ventilador, Alt. & A.A.
Caterpillar 3126 Diesel	2002	38567 36091 36096	SENSOR POLEA POLEA	Tensor Tensora - Ventilador, Alt. & A.A. guía
Mercedes-Benz MBE 900 Diesel	2002	38511 38567	SENSOR SENSOR	- Ventilador, Alt. & A.A. Tensor
Caterpillar 3126 Diesel	2001	36091 36096	POLEA POLEA	Tensora - Ventilador, Alt. & A.A. guía
Mercedes-Benz MBE 900 Diesel	2001	38511 38567	SENSOR SENSOR	- Ventilador, Alt. & A.A. Tensor
Caterpillar 3126 Diesel	2001	36091 36096	POLEA POLEA	Tensora - Ventilador, Alt. & A.A. guía
MERCEDES-BENZ MBE 900 DIESEL	2001	38567 38567	SENSOR SENSOR	Tensor Tensor

### A-LINE

Mercedes-Benz MBE 4000 Diesel	2008	38597 38501	SENSOR SENSOR	- Ventilador - Accessory Drive
Caterpillar C11 Diesel	2007	36093	POLEA	guía - ranurada
Caterpillar C13 Diesel	2007	36093	POLEA	guía - ranurada
Caterpillar C15 Diesel	2007	36091 36093	POLEA POLEA	guía - Lisa guía - ranurada
Caterpillar C11 Diesel	2006	38590 36093	SENSOR POLEA	- Ventilador, Alt. & A.A. guía - ranurada
Caterpillar C13 Diesel	2006	38590 36093	SENSOR POLEA	- Ventilador, Alt. & A.A. guía - ranurada
Caterpillar C15 Diesel	2006	38590 36093 36091	SENSOR POLEA POLEA	- Ventilador, Alt. & A.A. guía - ranurada guía - Lisa
Detroit Diesel 6-Cyl. 12.7 L Diesel	2006	38075 38076 38501	POLEA POLEA SENSOR	Tensora - Toma Fuerza, Alt. & A.A. Tensora - Ventilador - Toma Fuerza, Alt. & A.A.
Detroit Diesel 6-Cyl. 14.0 L Diesel	2006	38503 38501	SENSOR SENSOR	- Ventilador - Toma Fuerza, Alt. & A.A.

#### 388

Caterpillar C15 Diesel	2007	36093 36091	POLEA POLEA	guía - ranurada guía - Lisa
------------------------	------	----------------	----------------	--------------------------------

#### 389

Cummins ISX Diesel	2008	38587	SENSOR	- Ventilador & Alt.
--------------------	------	-------	--------	---------------------



Detroit Diesel 6-Cyl. 14.0 L Diesel	2006	38076	POLEA	Tensora - Ventilador
		38503	TENSOR	- Ventilador
		38075	POLEA	Tensora - Toma Fuerza, Alt. & A.A.
DETROIT DIESEL SERIE 60	2006	38075	POLEA	Toma de Fuerza, Alt y A.A.
		38076	POLEA	Vent.
		38503	TENSOR	Vent.
		38501	TENSOR	Toma de Fuerza, Alt. y A.A.
Mercedes-Benz MBE 4000 Diesel	2006	38597	TENSOR	- Ventilador
		38075	POLEA	Tensora - Toma Fuerza, Alt. & A.A.
		38501	TENSOR	- Toma Fuerza, Alt. & A.A.
Caterpillar C11 Diesel	2005	38590	TENSOR	- Ventilador, Alt. & A.A.
		36093	POLEA	guía - ranurada
Caterpillar C13 Diesel	2005	38590	TENSOR	- Ventilador, Alt. & A.A.
		36093	POLEA	guía - ranurada
Caterpillar C15 Diesel	2005	38590	TENSOR	- Ventilador, Alt. & A.A.
		36093	POLEA	guía - ranurada
		36091	POLEA	guía - Lisa
Detroit Diesel 6-Cyl. 12.7 L Diesel	2005	38501	TENSOR	- Toma Fuerza, Alt. & A.A.
		38076	POLEA	Tensora - Ventilador
		38075	POLEA	Tensora - Toma Fuerza, Alt. & A.A.
		38503	TENSOR	- Ventilador
Detroit Diesel 6-Cyl. 14.0 L Diesel	2005	38076	POLEA	Tensora - Ventilador
		38503	TENSOR	- Ventilador
		38075	POLEA	Tensora - Toma Fuerza, Alt. & A.A.
		38501	TENSOR	- Toma Fuerza, Alt. & A.A.
DETROIT DIESEL SERIE 60	2005	38075	POLEA	Toma de Fuerza, Alt y A.A.
		38501	TENSOR	Toma de Fuerza, Alt. y A.A.
		38501	TENSOR	Toma de Fuerza, Alt. y A.A.
		38076	POLEA	Tensora, Vent.
		38076	POLEA	Tensora, Vent.
		38075	POLEA	Toma de Fuerza, Alt y A.A.
		38503	TENSOR	Vent.
		38503	TENSOR	Tensor, Vent.
Mercedes-Benz MBE 4000 Diesel	2005	38597	TENSOR	- Ventilador
		38075	POLEA	Tensora - Toma Fuerza, Alt. & A.A.
		38501	TENSOR	- Toma Fuerza, Alt. & A.A.
Caterpillar C10 Diesel	2004	36091	POLEA	Tensora - A.A.
		36091	POLEA	Tensora - Ventilador & Alt.
		36091	POLEA	guía - Ventilador & Alt.
		38506	TENSOR	- Ventilador & Alt.
		38524	TENSOR	- A.A.
Caterpillar C11 Diesel	2004	38590	TENSOR	- Ventilador, Alt. & A.A.
		36093	POLEA	guía - ranurada
Caterpillar C12 Diesel	2004	36091	POLEA	guía - Ventilador & Alt.
		36091	POLEA	Tensora - Ventilador & Alt.
		36091	POLEA	Tensora - A.A.
		38524	TENSOR	- A.A.
		38506	TENSOR	- Ventilador & Alt.
Caterpillar C13 Diesel	2004	36093	POLEA	guía - ranurada
Caterpillar C15 Diesel	2004	36091	POLEA	guía - Lisa
		36093	POLEA	guía - ranurada
Detroit Diesel 6-Cyl. 12.7 L Diesel	2004	38076	POLEA	Tensora - Ventilador
		38503	TENSOR	- Ventilador
		38501	TENSOR	- Toma Fuerza, Alt. & A.A.
		38075	POLEA	Tensora - Toma Fuerza, Alt. & A.A.
Detroit Diesel 6-Cyl. 14.0 L Diesel	2004	38075	POLEA	- Toma Fuerza, Alt. & A.A.
		38076	POLEA	Tensora - Ventilador
		38503	TENSOR	- Ventilador
DETROIT DIESEL SERIE 60	2004	38075	POLEA	Toma de Fuerza, Alt y A.A.
		38503	TENSOR	Tensor, Vent.
		38076	POLEA	Tensora, Vent.
		38501	TENSOR	Tensor, Toma de Fuerza, Alt. y A.A.
Mercedes-Benz MBE 4000 Diesel	2004	38597	TENSOR	- Ventilador
		38075	POLEA	Tensora - Toma Fuerza, Alt. & A.A.
		38501	TENSOR	- Toma Fuerza, Alt. & A.A.
Caterpillar C10 Diesel	2003	36091	POLEA	guía - Ventilador & Alt.
		36091	POLEA	Tensora - A.A.
		36091	POLEA	Tensora - Ventilador & Alt.
		38506	TENSOR	- Ventilador & Alt.
		38524	TENSOR	- A.A.
Caterpillar C12 Diesel	2003	36091	POLEA	guía - Ventilador & Alt.
		36091	POLEA	Tensora - Ventilador & Alt.
		36091	POLEA	Tensora - A.A.
		38506	TENSOR	- Ventilador & Alt.

Caterpillar C10 Diesel	2002	38524	TENSOR	- A.A.
		36091	POLEA	Tensora - Ventilador & Alt.
		36091	POLEA	guía - Ventilador & Alt.
		36091	POLEA	Tensora - A.A.
		38506	TENSOR	- Ventilador & Alt.
		38524	TENSOR	- A.A.
Caterpillar C12 Diesel	2002	36091	POLEA	Tensora - A.A.
		36091	POLEA	Tensora - Ventilador & Alt.
		36091	POLEA	guía - Ventilador & Alt.
		38506	TENSOR	- Ventilador & Alt.
		38524	TENSOR	- A.A.
Detroit Diesel 6-Cyl. 11.1 L Diesel	2002	38524	TENSOR	- Toma Fuerza, Alt. & A.A.
Detroit Diesel 6-Cyl. 12.7 L Diesel	2002	38501	TENSOR	- Toma Fuerza, Alt. & A.A.
DETROIT DIESEL SERIE 60	2002	38501	TENSOR	Tensora, Toma de Fuerza, Alt. & A.A.
Detroit Diesel 6-Cyl. 11.1 L Diesel	2001	38501	TENSOR	- Toma Fuerza, Alt. & A.A.
		38075	POLEA	Tensora - Toma Fuerza, Alt. & A.A.
Detroit Diesel 6-Cyl. 12.7 L Diesel	2001	38075	POLEA	Tensora - Toma Fuerza, Alt. & A.A.
		38501	TENSOR	- Toma Fuerza, Alt. & A.A.
DETROIT DIESEL SERIE 60	2001	38502	TENSOR	Tensor, Toma de Fuerza & Alt.
		38075	POLEA	Tensora, Toma de Fuerza & Alt.
Detroit Diesel 6-Cyl. 11.1 L Diesel	2000	38502	TENSOR	- Toma Fuerza & Alt.
		38075	POLEA	Tensora - Toma Fuerza & Alt.
Detroit Diesel 6-Cyl. 12.7 L Diesel	2000	38075	POLEA	Tensora - Toma Fuerza & Alt.
		38502	TENSOR	- Toma Fuerza & Alt.

**L-LINE**

Detroit Diesel 6-Cyl. 12.7 L Diesel	2008	38503	TENSOR	- Ventilador
		38076	POLEA	Tensora - Ventilador
		38075	POLEA	Tensora - Toma Fuerza, Alt. & A.A.
		38501	TENSOR	- Toma Fuerza, Alt. & A.A.
Detroit Diesel 6-Cyl. 14.0 L Diesel	2008	38076	POLEA	Tensora - Ventilador
		38503	TENSOR	- Ventilador
		38501	TENSOR	- Toma Fuerza, Alt. & A.A.
		38075	POLEA	Tensora - Toma Fuerza, Alt. & A.A.
Caterpillar C11 Diesel	2007	38590	TENSOR	- Ventilador, Alt. & A.A.
		36093	POLEA	guía - ranurada
Caterpillar C13 Diesel	2007	38590	TENSOR	- Ventilador, Alt. & A.A.
		36093	POLEA	guía - ranurada
Caterpillar C15 Diesel	2007	38590	TENSOR	- Ventilador, Alt. & A.A.
		36093	POLEA	guía - ranurada
		36091	POLEA	guía - Lisa
Caterpillar C7 Diesel	2007	38586	TENSOR	- Ventilador & Alt.
		36091	POLEA	guía - Lisa
Caterpillar C9 Diesel	2007	38590	TENSOR	- Ventilador, Alt. & A.A.
Detroit Diesel 6-Cyl. 12.7 L Diesel	2007	38076	POLEA	Tensora - Ventilador
		38503	TENSOR	- Ventilador
		38501	TENSOR	- Toma Fuerza, Alt. & A.A.
		38075	POLEA	Tensora - Toma Fuerza, Alt. & A.A.
Detroit Diesel 6-Cyl. 14.0 L Diesel	2007	38076	POLEA	Tensora - Ventilador
		38503	TENSOR	- Ventilador
		38501	TENSOR	- Toma Fuerza, Alt. & A.A.
		38075	POLEA	Tensora - Toma Fuerza, Alt. & A.A.
Mercedes-Benz MBE 4000 Diesel	2007	38597	TENSOR	- Ventilador
		38075	POLEA	Tensora - Toma Fuerza, Alt. & A.A.
		38501	TENSOR	- Toma Fuerza, Alt. & A.A.
Caterpillar C11 Diesel	2006	38590	TENSOR	- Ventilador, Alt. & A.A.
		36093	POLEA	guía - ranurada
Caterpillar C13 Diesel	2006	38590	TENSOR	- Ventilador, Alt. & A.A.
		36093	POLEA	guía - ranurada
Caterpillar C15 Diesel	2006	38590	TENSOR	- Ventilador, Alt. & A.A.
		36093	POLEA	guía - ranurada
		36091	POLEA	guía - Lisa
Caterpillar C7 Diesel	2006	36091	POLEA	guía - Lisa
Caterpillar C9 Diesel	2006	36091	POLEA	guía
Detroit Diesel 6-Cyl. 12.7 L Diesel	2006	38076	POLEA	Tensora - Ventilador
		38503	TENSOR	- Ventilador
		38501	TENSOR	- Toma Fuerza, Alt. & A.A.
		38075	POLEA	Tensora - Toma Fuerza, Alt. & A.A.
Detroit Diesel 6-Cyl. 14.0 L Diesel	2006	38503	TENSOR	- Ventilador
		38076	POLEA	Tensora - Ventilador
		38501	TENSOR	- Toma Fuerza, Alt. & A.A.
		38075	POLEA	Tensora - Toma Fuerza, Alt. & A.A.
DETROIT DIESEL SERIE 60	2006	38503	TENSOR	Vent.
		38076	POLEA	Vent.
		38075	POLEA	Toma de Fuerza, Alt y A.A.



DETROIT DIESEL SERIE 60	2006	38501	SENSOR	Toma de Fuerza, Alt. y A.A.
Mercedes-Benz MBE 4000 Diesel	2006	38597	SENSOR	- Ventilador
		38501	SENSOR	- Toma Fuerza, Alt. & A.A.
		38075	POLEA	Tensora - Toma Fuerza, Alt. & A.A.
Caterpillar C11 Diesel	2005	38590	SENSOR	- Ventilador, Alt. & A.A.
		36093	POLEA	guía - ranurada
Caterpillar C13 Diesel	2005	38590	SENSOR	- Ventilador, Alt. & A.A.
		36093	POLEA	guía - ranurada
Caterpillar C15 Diesel	2005	38590	SENSOR	- Ventilador, Alt. & A.A.
		36091	POLEA	guía - Lisa
		36093	POLEA	guía - ranurada
Caterpillar C7 Diesel	2005	38550	SENSOR	- Ventilador, Alt. & A.A.
		36091	POLEA	Tensor, Vent., Alt. & A.A.
		36091	POLEA	guía - Lisa
Caterpillar C9 Diesel	2005	38590	SENSOR	- Ventilador, Alt. & A.A.
Detroit Diesel 6-Cyl. 12.7 L Diesel	2005	38076	POLEA	Tensora - Ventilador
		38503	SENSOR	- Ventilador
		38075	POLEA	Tensora - Toma Fuerza, Alt. & A.A.
		38501	SENSOR	- Toma Fuerza, Alt. & A.A.
Detroit Diesel 6-Cyl. 14.0 L Diesel	2005	38076	POLEA	Tensora - Ventilador
		38503	SENSOR	- Ventilador
		38501	SENSOR	- Toma Fuerza, Alt. & A.A.
		38075	POLEA	Tensora - Toma Fuerza, Alt. & A.A.
DETROIT DIESEL SERIE 60	2005	38076	POLEA	Tensora, Vent.
		38503	SENSOR	Tensor, Vent.
		38075	POLEA	Toma de Fuerza, Alt y A.A.
Mercedes-Benz MBE 4000 Diesel	2005	38597	SENSOR	Tensor, Toma de Fuerza, Alt. y A.A.
		38501	SENSOR	- Ventilador
		38501	SENSOR	- Toma Fuerza, Alt. & A.A.
		38075	POLEA	Tensora - Toma Fuerza, Alt. & A.A.
Caterpillar 3126 Diesel	2004	36091	POLEA	Tensora - Ventilador, Alt. & A.A.
		38511	SENSOR	- Ventilador, Alt. & A.A.
Caterpillar C11 Diesel	2004	38590	SENSOR	- Ventilador, Alt. & A.A.
		36093	POLEA	guía - ranurada
Caterpillar C13 Diesel	2004	38590	SENSOR	- Ventilador, Alt. & A.A.
		36093	POLEA	guía - ranurada
Caterpillar C15 Diesel	2004	36091	POLEA	guía - ranurada
		36091	POLEA	guía - Lisa
Caterpillar C7 Diesel	2004	38511	SENSOR	- Ventilador, Alt. & A.A.
		36091	POLEA	Tensora - Ventilador, Alt. & A.A.
Detroit Diesel 6-Cyl. 12.7 L Diesel	2004	38076	POLEA	Tensora - Ventilador
		38503	SENSOR	- Ventilador
		38501	SENSOR	- Toma Fuerza, Alt. & A.A.
		38075	POLEA	Tensora - Toma Fuerza, Alt. & A.A.
Detroit Diesel 6-Cyl. 14.0 L Diesel	2004	38503	SENSOR	- Ventilador
		38076	POLEA	Tensora - Ventilador
		38075	POLEA	Tensora - Toma Fuerza, Alt. & A.A.
		38501	SENSOR	- Toma Fuerza, Alt. & A.A.
DETROIT DIESEL SERIE 60	2004	38076	POLEA	Tensora, Vent.
		38503	SENSOR	Tensor, Vent.
		38075	POLEA	Toma de Fuerza, Alt y A.A.
Mercedes-Benz MBE 4000 Diesel	2004	38597	SENSOR	Tensor, Toma de Fuerza, Alt. y A.A.
		38075	POLEA	- Ventilador
		38501	SENSOR	Tensora - Toma Fuerza, Alt. & A.A.
Caterpillar 3126 Diesel	2003	38511	SENSOR	- Ventilador, Alt. & A.A.
		36091	POLEA	Tensora
		38511	SENSOR	Tensor, Vent., Alt., C/AA
		36091	POLEA	Tensora - Ventilador, Alt. & A.A.
Cummins ISC Diesel	2003	36091	POLEA	Tensora - Ventilador, Alt. & Toma Fuerza
		38513	SENSOR	- Ventilador, Alt. & Toma Fuerza
Detroit Diesel 6-Cyl. 12.7 L Diesel	2003	38075	POLEA	Tensora - Toma Fuerza, Alt. & A.A.
		38502	SENSOR	- Toma Fuerza, Alt. & A.A.
Detroit Diesel 6-Cyl. 14.0 L Diesel	2003	38075	POLEA	Tensora - Toma Fuerza, Alt. & A.A.
		38502	SENSOR	- Toma Fuerza, Alt. & A.A.
DETROIT DIESEL SERIE 60	2003	38075	POLEA	Tensora, Toma de Fuerza, Alt. y A.A.
		38502	SENSOR	Tensor, Toma de Fuerza, Alt. y A.A.
Mercedes-Benz MBE 4000 Diesel	2003	38597	SENSOR	- Ventilador
		38501	SENSOR	- Toma Fuerza, Alt. & A.A.
		38075	POLEA	Tensora - Toma Fuerza, Alt. & A.A.
Caterpillar 3126 Diesel	2002	38511	SENSOR	- Ventilador, Alt. & A.A.
		38511	SENSOR	Tensor, Vent., Alt. & A.A.
		36091	POLEA	Tensora - Ventilador, Alt. & A.A.
		36091	POLEA	Tensora, Vent., Alt. & A.A.
Detroit Diesel 6-Cyl. 11.1 L Diesel	2002	38501	SENSOR	- Toma Fuerza, Alt. & A.A.

Detroit Diesel 6-Cyl. 12.7 L Diesel	2002	38501	SENSOR	- Toma Fuerza, Alt. & A.A.
DETROIT DIESEL SERIE 60	2002	38501	SENSOR	Tensora, Toma de Fuerza, Alt. & A.A.
CATERPILLAR 3126 DIESEL	2001	36091	POLEA	Tensora, Vent., Alt. & A.A.
		36091	POLEA	Tensora - Ventilador, Alt. & A.A.
		38511	SENSOR	Tensor, Vent., Alt. & A.A.
		38511	SENSOR	- Ventilador, Alt. & A.A.
Cummins ISC Diesel	2001	36091	POLEA	Tensora - Ventilador, Alt. & Toma Fuerza
		38513	SENSOR	- Ventilador, Alt. & Toma Fuerza
Cummins ISX Diesel	2001	36092	POLEA	Tensora - Ventilador
		36095	POLEA	Tensora - Toma Fuerza, Alt. & A.A.
		38535	SENSOR	- Ventilador
		38532	SENSOR	- Toma Fuerza, Alt. & A.A.
CUMMINS SIGNATURE 600	2001	36092	POLEA	Tensora, Vent.
		38535	SENSOR	Tensor, Vent.
		36095	POLEA	Tensora, Toma de Fuerza, Alt. & A.A.
		38532	SENSOR	Tensor, Toma de Fuerza, Alt. & A.A.
Cummins Signature 600 Diesel	2001	36092	POLEA	Tensora - Ventilador
		38532	SENSOR	- Toma Fuerza, Alt. & A.A.
		38535	SENSOR	- Ventilador
		36095	POLEA	Tensora - Toma Fuerza, Alt. & A.A.
Detroit Diesel 6-Cyl. 11.1 L Diesel	2001	38075	POLEA	Tensora - Toma Fuerza & Alt.
		38502	SENSOR	- Toma Fuerza & Alt.
Detroit Diesel 6-Cyl. 12.7 L Diesel	2001	38075	POLEA	Tensora - Toma Fuerza & Alt.
DETROIT DIESEL SERIE 60	2001	38502	SENSOR	- Toma Fuerza & Alt.
		38075	POLEA	Tensor, Toma de Fuerza & Alt.
Caterpillar 3126 Diesel	2000	36091	POLEA	Tensora, Toma de Fuerza, Alt. & A.A.
		38511	SENSOR	- Ventilador, Alt. & A.A.
Cummins ISB Diesel	2000	36093	POLEA	Tensora - Ventilador, Alt. & Toma Fuerza
		38516	SENSOR	- Ventilador, Alt. & Toma Fuerza
Cummins ISC Diesel	2000	36091	POLEA	Tensora - Ventilador, Alt. & Toma Fuerza
		38513	SENSOR	- Ventilador, Alt. & Toma Fuerza
Detroit Diesel 6-Cyl. 11.1 L Diesel	2000	38502	SENSOR	- Toma Fuerza & Alt.
		38075	POLEA	Tensora - Toma Fuerza & Alt.
Detroit Diesel 6-Cyl. 12.7 L Diesel	2000	38075	POLEA	Tensora - Toma Fuerza & Alt.
		38502	SENSOR	- Toma Fuerza & Alt.

## THOMAS BUILT

### CONVENTIONAL

Mercedes-Benz MBE 900 Diesel	2006	38567	SENSOR	- Alt.
Caterpillar 3126 Diesel	2003	36091	POLEA	Tensora - Ventilador, Alt. & A.A.
		38511	SENSOR	- Ventilador, Alt. & A.A.
Cummins ISB Diesel	2003	36093	POLEA	Tensora
		38516	SENSOR	
Caterpillar 3126 Diesel	2002	38511	SENSOR	- Ventilador, Alt. & A.A.
		36091	POLEA	Tensora - Ventilador, Alt. & A.A.
Cummins ISB Diesel	2002	36093	POLEA	Tensora
		38516	SENSOR	
Caterpillar 3126 Diesel	2001	36091	POLEA	Tensora - Ventilador, Alt. & A.A.
		38511	SENSOR	- Ventilador, Alt. & A.A.
Cummins ISB Diesel	2001	36093	POLEA	Tensora
		38516	SENSOR	
Caterpillar 3126 Diesel	2000	38511	SENSOR	- Ventilador, Alt. & A.A.
		36091	POLEA	Tensora - Ventilador, Alt. & A.A.
Cummins ISB Diesel	2000	36093	POLEA	Tensora
		38516	SENSOR	
Caterpillar 3126 Diesel	1999	36091	POLEA	Tensora - Ventilador, Alt. & A.A.
		38511	SENSOR	- Ventilador, Alt. & A.A.
Caterpillar 3126 Diesel	1998	38511	SENSOR	- Ventilador, Alt. & A.A.
		36091	POLEA	Tensora - Ventilador, Alt. & A.A.

### MINOTOUR

GM V-8 6.0 L	2006	38158	SENSOR	- Serpentine
		38001	POLEA	guía - Serpentine
		38159	SENSOR	- A.A.
		38009	POLEA	Tensora - Serpentine
GM V-8 4.8 L	2005	38159	SENSOR	- A.A.
		38158	SENSOR	- Alt. & B.A.
GM V-8 6.0 L	2005	38001	POLEA	guía - Serpentine
		38159	SENSOR	- A.A.

GM V-8 6.0 L	2005	38158 38009	TENSOR POLEA	- Serpentine Tensora - Serpentine
GM V-8 4.8 L	2004	38159	TENSOR	- A.A.
		38158	TENSOR	- Serpentine
		38001	POLEA	guía - Serpentine
GM V-8 5.7 L	2001	38009	POLEA	Tensora - Serpentine
		38103	TENSOR	
		38008	POLEA	Tensora

Cummins ISC Diesel	1998	36091 38513	POLEA TENSOR	Tensora - Toma Fuerza & Alt. - Alt. & B.A.

### SAF-T-LINER C2

Mercedes-Benz MBE 900 Diesel	2009	38567	TENSOR	
Caterpillar C7 Diesel	2008	38550	TENSOR	- Ventilador, B.A. & Alt.
		36093	POLEA	guía - ranurada
		36091	POLEA	guía - Lisa
Mercedes-Benz MBE 900 Diesel	2008	38567	TENSOR	- Ventilador & Alt.

### SAF-T-LINER MVP EF

Caterpillar C7 Diesel	2006	38550	TENSOR	- Alt.
Caterpillar C7 Diesel	2005	38550	TENSOR	- Alt.
Caterpillar 3126 Diesel	2004	36091	POLEA	Tensora - Ventilador, Alt. & A.A.
		38511	TENSOR	- Ventilador, Alt. & A.A.
Caterpillar 3126 Diesel	2003	36091	POLEA	Tensora - Ventilador, Alt. & A.A.
		38511	TENSOR	- Ventilador, Alt. & A.A.
Caterpillar 3126 Diesel	2002	38511	TENSOR	- Ventilador, Alt. & A.A.
		36091	POLEA	Tensora - Ventilador, Alt. & A.A.
Cummins ISB Diesel	2002	36093	POLEA	Tensora - Ventilador, Alt. & Toma Fuerza
		36091	POLEA	Tensora - Ventilador & A.A.
		38513	TENSOR	- Ventilador & A.A.
Caterpillar 3126 Diesel	2001	38516	TENSOR	- Ventilador, Alt. & Toma Fuerza
		36091	POLEA	Tensora - Ventilador, Alt. & A.A.
		38511	TENSOR	- Ventilador, Alt. & A.A.
Cummins ISB Diesel	2001	36091	POLEA	Tensora - Ventilador & A.A.
		36093	POLEA	Tensora - Ventilador, Alt. & Toma Fuerza
		38513	TENSOR	- Ventilador & A.A.
Caterpillar 3126 Diesel	2000	38516	TENSOR	- Ventilador, Alt. & Toma Fuerza
		36091	POLEA	Tensora - Ventilador, Alt. & A.A.
		38511	TENSOR	- Ventilador, Alt. & A.A.
Cummins ISB Diesel	2000	36093	POLEA	Tensora - Ventilador, Alt. & Toma Fuerza
		36091	POLEA	Tensora - Ventilador & A.A.
Caterpillar 3126 Diesel	1999	38513	TENSOR	- Ventilador & A.A.
		38516	TENSOR	- Ventilador, Alt. & Toma Fuerza
Caterpillar 3126 Diesel	1998	36091	POLEA	Tensora - Ventilador, Alt. & A.A.
		38511	TENSOR	- Ventilador, Alt. & A.A.

### SAF-T-LINER MVP ER

John Deere 6-Cyl. 8.1 L CNG	2007	38507	TENSOR	- A.A.
John Deere 6-Cyl. 8.1 L CNG	2006	38507	TENSOR	- Alt.
Caterpillar C7 Diesel	2005	38550	TENSOR	- Alt. & B.A.
John Deere 6-Cyl. 8.1 L CNG	2005	38507	TENSOR	- Alt.
Caterpillar 3126 Diesel	2004	38511	TENSOR	- Alt.
		36091	POLEA	Tensora - Alt.
Caterpillar C7 Diesel	2004	38550	TENSOR	- Alt. & B.A.
		38507	TENSOR	- Alt.
John Deere 6-Cyl. 8.1 L CNG	2004	38507	TENSOR	- Toma Fuerza & Alt.
Caterpillar 3126 Diesel	2003	38511	TENSOR	Tensora - Toma Fuerza & Alt.
		36091	POLEA	Tensora - Toma Fuerza & Alt.
John Deere 6-Cyl. 8.1 L CNG	2003	36091	POLEA	Tensora - Mot. a Alt.
		38507	TENSOR	- Mot. a Alt.
Caterpillar 3126 Diesel	2002	38511	TENSOR	- Toma Fuerza & Alt.
		36091	POLEA	Tensora - Toma Fuerza & Alt.
John Deere 6-Cyl. 8.1 L CNG	2002	36091	POLEA	Tensora
		38507	TENSOR	
Caterpillar 3126 Diesel	2001	36091	POLEA	Tensora - Toma Fuerza & Alt.
		38511	TENSOR	- Toma Fuerza & Alt.
John Deere 6-Cyl. 8.1 L CNG	2001	36091	POLEA	Tensora - Toma Fuerza & Alt.
		38507	TENSOR	- Toma Fuerza & Alt.
Cummins ISB Diesel	2000	36093	POLEA	Tensora - Alt. & B.A.
		38516	TENSOR	- Alt. & B.A.
Cummins ISC Diesel	2000	36093	POLEA	Tensora - Alt. & B.A.
		38516	TENSOR	- Alt. & B.A.
Cummins ISB Diesel	1999	36093	POLEA	Tensora - Alt. & B.A.
		38516	TENSOR	- Alt. & B.A.

## VOLKSWAGEN

### 15-190 WORKER

Cummins Interact 5.9 DIESEL (EURO III)	2008	38584	TENSOR	
Cummins Interact 5.9 DIESEL (EURO III)	2007	38584	TENSOR	
Cummins Interact 5.9 DIESEL (EURO III)	2006	38584	TENSOR	
Cummins Interact 5.9 DIESEL (EURO III)	2005	38584	TENSOR	

### 17-210 VOLKSBUS

MWM de 6.2 DIESEL ELECTRONICO	2008	38584	TENSOR	
MWM de 6.2 DIESEL ELECTRONICO	2007	38584	TENSOR	
MWM de 6.2 DIESEL ELECTRONICO	2006	38584	TENSOR	
MWM de 6.2 DIESEL ELECTRONICO	2005	38584	TENSOR	

### 17-250 WORKER

Cummins Interact 5.9 DIESEL (EURO III)	2008	38584	TENSOR	
Cummins Interact 5.9 DIESEL (EURO III)	2007	38584	TENSOR	
Cummins Interact 5.9 DIESEL (EURO III)	2006	38584	TENSOR	
Cummins Interact 5.9 DIESEL (EURO III)	2005	38584	TENSOR	

### 24-250 WORKER

Cummins Interact 5.9 DIESEL (EURO III)	2008	38584	TENSOR	
Cummins Interact 5.9 DIESEL (EURO III)	2007	38584	TENSOR	
Cummins Interact 5.9 DIESEL (EURO III)	2006	38584	TENSOR	
Cummins Interact 5.9 DIESEL (EURO III)	2005	38584	TENSOR	

### 8-150 VOLKSBUS

Cummins Interact 3.9 DIESEL (EURO III)	2008	38584	TENSOR	
Cummins Interact 3.9 DIESEL (EURO III)	2007	38584	TENSOR	
Cummins Interact 3.9 DIESEL (EURO III)	2006	38584	TENSOR	
Cummins Interact 3.9 DIESEL (EURO III)	2005	38584	TENSOR	

### 8-150 WORKER

Cummins Interact 3.9 DIESEL (EURO III)	2008	38584	TENSOR	
Cummins Interact 3.9 DIESEL (EURO III)	2007	38584	TENSOR	
Cummins Interact 3.9 DIESEL (EURO III)	2006	38584	TENSOR	
Cummins Interact 3.9 DIESEL (EURO III)	2005	38584	TENSOR	

## VOLVO

### 7550

7550	2006	38531	TENSOR	CIGÜEÑAL AL COMPRESOR A.A.
7550	2005	38531	TENSOR	CIGÜEÑAL AL COMPRESOR A.A.
7550	2004	38531	TENSOR	CIGÜEÑAL AL COMPRESOR A.A.
7550	2003	38531	TENSOR	CIGÜEÑAL AL COMPRESOR A.A.
7550	2002	38531	TENSOR	CIGÜEÑAL AL COMPRESOR A.A.
7550	2001	38531	TENSOR	CIGÜEÑAL AL COMPRESOR A.A.

### 7550 FL

7550 FL	2008	38531	TENSOR	CIGÜEÑAL AL COMPRESOR A.A.
7550 FL	2007	38531	TENSOR	CIGÜEÑAL AL COMPRESOR A.A.
7550 FL	2006	38531	TENSOR	CIGÜEÑAL AL COMPRESOR A.A.
7550 FL	2005	38531	TENSOR	CIGÜEÑAL AL COMPRESOR A.A.

### 9700

9700	2006	38531	TENSOR	CIGÜEÑAL AL COMPRESOR A.A.
9700	2005	38531	TENSOR	CIGÜEÑAL AL COMPRESOR A.A.
9700	2004	38531	TENSOR	CIGÜEÑAL AL COMPRESOR A.A.
9700	2003	38531	TENSOR	CIGÜEÑAL AL COMPRESOR A.A.



9700	2002	38531	TENSOR	CIGÜENAL AL COMPRESOR A.A.
------	------	-------	--------	----------------------------

**9700 FL**

9700 FL	2008	38607	TENSOR	MICRO-V
9700 FL	2007	38607	TENSOR	MICRO-V
9700 FL	2006	38607	TENSOR	MICRO-V
9700 FL	2005	38607	TENSOR	MICRO-V

**AUTOCAR**

Detroit Diesel 6-Cyl. 11.1 L Diesel	1998	36091	POLEA	Tensora
		38505	TENSOR	- Ventilador & Alt.
Detroit Diesel 6-Cyl. 12.7 L Diesel	1998	36091	POLEA	Tensora
		38505	TENSOR	- Ventilador & Alt.

**VHD**

Volvo VE D12 Diesel	2008	38585	TENSOR	- Alt. & A.A.
		38581	TENSOR	- Ventilador
Volvo VE D12 Diesel	2007	38585	TENSOR	- Alt. & A.A.
		38581	TENSOR	- Ventilador
Volvo VE D12 Diesel	2006	38581	TENSOR	- Ventilador
		38585	TENSOR	- Alt. & A.A.
Volvo VE D12 Diesel	2005	38581	TENSOR	- Ventilador
		38585	TENSOR	- Alt. & A.A.
Volvo VE D12 Diesel	2004	38581	TENSOR	- Ventilador
Cummins ISM Diesel	2003	38607	TENSOR	- Toma Fuerza & A.A.
		36092	POLEA	Tensora - Ventilador & Alt.
		38539	TENSOR	- Ventilador & Alt.
Volvo VE D12 Diesel	2003	38581	TENSOR	- Ventilador
Cummins ISM Diesel	2002	38607	TENSOR	- Toma Fuerza & A.A.
		36092	POLEA	Tensora - Ventilador & Alt.
		38539	TENSOR	- Ventilador & Alt.
Volvo VE 12 Diesel	2002	38581	TENSOR	- Ventilador
Volvo VE D12 Diesel	2002	38547	TENSOR	- Ventilador
Volvo VE D12 Diesel	2001	38547	TENSOR	- Ventilador

**VN SERIES**

Volvo D16 Diesel	2008	38585	TENSOR	- Alt. & A.A.
		38581	TENSOR	- Ventilador
Volvo VE D12 Diesel	2008	38581	TENSOR	- Ventilador
		38585	TENSOR	- Alt. & A.A.
Volvo VE D16 Diesel	2008	38585	TENSOR	- Alt. & A.A.
		38581	TENSOR	- Ventilador
Cummins ISX Diesel	2007	38587	TENSOR	- Ventilador & Alt.
Volvo VE D12 Diesel	2007	38581	TENSOR	- Ventilador
		38585	TENSOR	- Alt. & A.A.
Volvo VE D16 Diesel	2007	38581	TENSOR	- Ventilador
		38585	TENSOR	- Alt. & A.A.
Cummins ISX Diesel	2006	38587	TENSOR	- Ventilador & Alt.
Volvo VE D12 Diesel	2006	38585	TENSOR	- Alt. & A.A.
		38581	TENSOR	- Ventilador
Volvo VE D16 Diesel	2006	38585	TENSOR	- Alt. & A.A.
		38581	TENSOR	- Ventilador
Cummins ISX Diesel	2005	38587	TENSOR	- Ventilador & Alt.
Volvo VE D12 Diesel	2005	38585	TENSOR	- Alt. & A.A.
		38581	TENSOR	- Ventilador
Cummins ISX Diesel	2004	38587	TENSOR	- Ventilador & Alt.
Volvo VE D12 Diesel	2004	38585	TENSOR	- Alt. & A.A.
		38581	TENSOR	- Ventilador
Cummins ISM Diesel	2003	38607	TENSOR	- Toma Fuerza & A.A.
		36092	POLEA	Tensora - Ventilador & Alt.
		38539	TENSOR	- Ventilador & Alt.
Cummins ISX Diesel	2003	38587	TENSOR	- Ventilador & Alt.
		36092	POLEA	Tensora - Ventilador
		38532	TENSOR	- Toma Fuerza, Alt. & A.A.
		36095	POLEA	Tensora - Toma Fuerza, Alt. & A.A.
Cummins N14 Diesel	2003	36098	POLEA	Tensora - Ventilador
Cummins Signature 600 Diesel	2003	38587	TENSOR	- Ventilador & Alt.
		36092	POLEA	Tensora - Ventilador
		36095	POLEA	Tensora - Toma Fuerza, Alt. & A.A.
		38535	TENSOR	- Ventilador
		38532	TENSOR	- Toma Fuerza, Alt. & A.A.



Cummins ISM Diesel	2002	38607	TENSOR	- Toma Fuerza & A.A.
		36092	POLEA	Tensora - Ventilador & Alt.
		38539	TENSOR	- Ventilador & Alt.
Cummins ISX Diesel	2002	36092	POLEA	Tensora - Ventilador
		38535	TENSOR	- Ventilador
		36095	POLEA	Tensora - Toma Fuerza, Alt. & A.A.
		38532	TENSOR	- Toma Fuerza, Alt. & A.A.
Cummins N14 Diesel	2002	36098	POLEA	Tensora - Ventilador
		38536	TENSOR	- Ventilador
Cummins ISM Diesel	2001	38545	TENSOR	- A.A.
Cummins ISX Diesel	2001	36092	POLEA	Tensora - Ventilador
		36095	POLEA	Tensora - Toma Fuerza, Alt. & A.A.
		38532	TENSOR	- Toma Fuerza, Alt. & A.A.
		38535	TENSOR	- Ventilador
Cummins N14 Diesel	2001	36098	POLEA	Tensora - Ventilador
		38536	TENSOR	- Ventilador
Detroit Diesel 6-Cyl. 11.1 L Diesel	2001	36091	POLEA	Tensora
		38505	TENSOR	- Ventilador & Alt.
Detroit Diesel 6-Cyl. 12.7 L Diesel	2001	36091	POLEA	Tensora
		38505	TENSOR	- Ventilador & Alt.
Cummins ISX Diesel	2000	36092	POLEA	Tensora - Ventilador
		36095	POLEA	Tensora - Toma Fuerza, Alt. & A.A.
		38535	TENSOR	- Ventilador
Cummins N14 Diesel	2000	38532	TENSOR	- Toma Fuerza, Alt. & A.A.
		36098	POLEA	Tensora - Ventilador
		38536	TENSOR	- Ventilador
Detroit Diesel 6-Cyl. 11.1 L Diesel	2000	36091	POLEA	Tensora
		38505	TENSOR	- Ventilador & Alt.
Detroit Diesel 6-Cyl. 12.7 L Diesel	2000	36091	POLEA	Tensora
		38505	TENSOR	- Ventilador & Alt.
Caterpillar 3406 Diesel	1999	36091	POLEA	Tensora
		38505	TENSOR	- Ventilador & Alt.
Detroit Diesel 6-Cyl. 11.1 L Diesel	1999	36091	POLEA	Tensora
		38505	TENSOR	- Ventilador & Alt.
Detroit Diesel 6-Cyl. 12.7 L Diesel	1999	36091	POLEA	Tensora
		38505	TENSOR	- Ventilador & Alt.
Detroit Diesel 6-Cyl. 11.1 L Diesel	1998	36091	POLEA	Tensora
		38505	TENSOR	- Ventilador & Alt.
Detroit Diesel 6-Cyl. 12.7 L Diesel	1998	36091	POLEA	Tensora
		38505	TENSOR	- Ventilador & Alt.

**VNL**

CUMMINS N14	2003	38536	TENSOR	B.A., Toma de Fuerza
CUMMINS N14	2002	38536	TENSOR	B.A., Toma de Fuerza

**VNL 64T 420**

DETROIT DIESEL SERIE 60	2001	38076	POLEA	Loca
		38505	TENSOR	

**VNL 64T 420 6X4 TIPICO**

DETROIT DIESEL SERIE 60	2000	38076	POLEA	Loca
		38505	TENSOR	
DETROIT DIESEL SERIE 60	1999	38076	POLEA	Loca
		38505	TENSOR	

**VNL 64T 420 STANDAR**

DETROIT DIESEL SERIE 60	2000	38076	POLEA	Loca
		38505	TENSOR	
DETROIT DIESEL SERIE 60	1999	38076	POLEA	Loca
		38505	TENSOR	

**VNL 64T 610**

DETROIT DIESEL SERIE 60	2000	38076	POLEA	Loca
		38505	TENSOR	
DETROIT DIESEL SERIE 60	1999	38076	POLEA	Loca
		38505	TENSOR	

**VNM**

CUMMINS N14	2003	38536	TENSOR	B.A., Toma de Fuerza
CUMMINS N14	2002	38536	TENSOR	B.A., Toma de Fuerza



### VT SERIES

Volvo VE D16 Diesel	2008	38581	TENSOR	- Ventilador
		38585	TENSOR	- Alt. & A.A.
Volvo VE D16 Diesel	2007	38585	TENSOR	- Alt. & A.A.
		38581	TENSOR	- Ventilador
Cummins ISX Diesel	2006	38587	TENSOR	- Ventilador & Alt.
Volvo VE D16 Diesel	2006	38581	TENSOR	- Ventilador
		38585	TENSOR	- Alt. & A.A.

### WG SERIES

Volvo VE D12 Diesel	2001	38531	TENSOR	- Ventilador & Toma Fuerza
Volvo VE D12 Diesel	2000	38531	TENSOR	- Ventilador & Toma Fuerza
Volvo VE D12 Diesel	1999	38531	TENSOR	- Ventilador & Toma Fuerza
		38531	TENSOR	- Alt. & A.A.
Volvo VE D12 Diesel	1998	38531	TENSOR	- Ventilador & Toma Fuerza



# ***Aplicación por producto Servicio Ligero***



***La marca de más prestigio en bandas, mangueras, hidráulica y neumática***

**TCKS & COMPONENTES**

**TCK017**



VOLKSWAGEN	GOLF	4 CIL. 1.8 L	1995 - 1995
VOLKSWAGEN	JETTA	4 CIL. 1.8 L	1995 - 1995

**TCK1013M**



HYUNDAI	ATOS	4 CIL. 1.1 L	2005 - 2010
HYUNDAI	ATOS	4 CIL. 1.0 L	2000 - 2004
HYUNDAI	ATOS	4 CIL. 1.1 L	2005 - 2010
HYUNDAI	ATOS	4 CIL. 1.0 L	2000 - 2004

**TCK1022M**



CHEVROLET	ZAFIRA	4 CIL. 2.0 L	2004 - 2006
CHEVROLET	ASTRA	4 CIL. 2.0 L	2004 - 2006

**TCK104**



NISSAN	MAXIMA	V6, 3.0 L	1993 - 1994
--------	--------	-----------	-------------

**TCK1094**



CHEVROLET	ASTRA	4 CIL. 1.8 L	2000 - 2003
CHEVROLET	CORSA	4 CIL. 1.4 L	2002 - 2003
CHEVROLET	ZAFIRA	4 CIL. 1.8 L	2000 - 2003

**TCK1095M**



NISSAN	PLATINA	4 CIL. 1.6 L	2002 - 2010
NISSAN	APRIO	4 CIL. 1.6 L	2008 - 2010
RENAULT	KANGOO	4 CIL. 1.6 L	2004 - 2004
RENAULT	STEPWAY	4 CIL. 1.6 L	2010 - 2010
RENAULT	KANGOO	4 CIL. 1.6 L	2003 - 2010
RENAULT	KANGOO	4 CIL. 1.6 L	2005 - 2010
RENAULT	EUROCLIO	4 CIL. 1.6 L	2007 - 2008
RENAULT	KANGOO EXPRES!	4 CIL. 1.6 L	2005 - 2009
RENAULT	CLIO	4 CIL. 1.6 L	2003 - 2009
RENAULT	SANDERO	4 CIL. 1.6 L	2010 - 2010
NISSAN	PLATINA	4 CIL. 1.6 L	2002 - 2008
NISSAN	PLATINA	4 CIL. 1.6 L	2009 - 2010

NISSAN	APRIO	4 CIL.1.6 L	2008 - 2010
RENAULT	CLIO	4 CIL.1.6 L	2003 - 2009

**TCK153**



**TCK124M**



CHRYSLER	LEBARON	4 CIL. 2.5 L	1994 - 1994
DODGE	SHADOW	4 CIL. 2.2 L	1994 - 1994
DODGE	CARAVAN	4 CIL. 2.5 L	1995 - 1995
DODGE	SHADOW	4 CIL. 2.5 L	1994 - 1994
DODGE	SPIRIT	4 CIL. 2.5 L	1994 - 1994
CHRYSLER	LEBARON	4 CIL. 2.5 L	1993 - 1993

HYUNDAI	H100	4 CIL. 2.4 L	2003 - 2005
---------	------	--------------	-------------

**TCK1284M**



**TCK1548**



RENAULT	MEGANE	4 CIL. 2.0 L	2001 - 2003
RENAULT	SCENIC	4 CIL. 2.0 L	2001 - 2003

VOLKSWAGEN	SAVEIRO	4 CIL. 1.6 L	2010 - 2010
VOLKSWAGEN	POLO	4 CIL. 1.6 L	2005 - 2005
VOLKSWAGEN	POLO	4 CIL. 1.6 L	2006 - 2007
SEAT	CORDOBA	4 CIL. 1.6 L	2003 - 2008
SEAT	IBIZA	4 CIL. 1.6 L	2003 - 2009
VOLKSWAGEN	LUPO	4 CIL. 1.6 L	2004 - 2008
VOLKSWAGEN	CROSSFOX	4 CIL. 1.6 L	2006 - 2008
VOLKSWAGEN	CROSSFOX	4 CIL. 1.6 L	2005 - 2005
VOLKSWAGEN	GOL	4 CIL. 1.6 L	2009 - 2010
VOLKSWAGEN	SPORTVAN	4 CIL. 1.6 L	2006 - 2008

**TCK139**



CHRYSLER	LEBARON	V6, 3.0 L	1993 - 1995
CHRYSLER	VOYAGER	V6, 3.0 L	1996 - 2001
CHRYSLER	LEBARON	V6, 3.0 L	1994 - 1994
DODGE	SPIRIT	V6, 3.0 L	1994 - 1994
CHRYSLER	GRAND VOYAGER	V6, 3.3 L	2000 - 2000
DODGE	CARAVAN	V6, 3.0 L	1994 - 1995

**TCK1565M**





RENAULT ..... MEGANE ..... 4 CIL. 2.0 L ..... 2004 ..... 2009

**TCK194**

**TCK1570M**



CHEVROLET ..... MATIZ ..... 4 CIL. 1.0 L ..... 2010 ..... 2011

PONTIAC ..... MATIZ G2 ..... 4 CIL. 1.0 L ..... 2003 ..... 2009

FORD ..... ESCORT ..... 4 CIL. 1.9 L ..... 1994 ..... 1996

**TCK199**

**TCK179**



FORD ..... ESCORT ..... 4 CIL. 1.8 L ..... 1994 ..... 1996

TOYOTA ..... CAMRY ..... 4 CIL. 2.2 L ..... 2001 ..... 2001

**TCK201**

**TCK184**



HONDA ..... CR-V ..... 4 CIL. 2.0 L ..... 1999 ..... 2001

MITSUBISHI ..... LANCER ..... 4 CIL. 2.0 L ..... 2007 ..... 2008

**TCK203**

**TCK192**



CHEVROLET ..... LUMINA ..... V6, 3.4 L ..... 1997 ..... 1998

CHEVROLET ..... LUMINA ..... V6, 3.4 L ..... 1993 ..... 1995

CHEVROLET ..... CHEVY SWING ..... 4 CIL. 1.6 L ..... 1994 ..... 2003

CHEVROLET ..... CHEVY ..... 4 CIL. 1.6 L ..... 2009 ..... 2010

CHEVROLET ..... CHEVY C2 ..... 4 CIL. 1.6 L ..... 2004 ..... 2008

CHEVROLET ..... CHEVY C2 SEDAN ..... 4 CIL. 1.6 L ..... 2004 ..... 2008

CHEVROLET ..... CHEVY JOY ..... 4 CIL. 1.6 L ..... 1994 ..... 2003

CHEVROLET ..... CHEVY POP ..... 4 CIL. 1.6 L ..... 1994 ..... 2003

CHEVROLET	MONZA	4 CIL. 1.6 L	1994	-	2004
CHEVROLET	CHEVY PICK-UP	4 CIL. 1.6 L	2002	-	2006

**TCK244**



HONDA	ACCORD	4 CIL. 2.3 L	1998	-	2001
HONDA	ACCORD	4 CIL. 2.3 L	2002	-	2002

**TCK212**



CHEVROLET	TRACKER	4 CIL. 1.6 L	1998	-	2000
-----------	---------	--------------	------	---	------

**TCK245**



CHRYSLER	CIRRUS	4 CIL. 2.0 L	2000	-	2000
DODGE	NEON	4 CIL. 2.0 L	2002	-	2002
DODGE	NEON	4 CIL. 2.0 L	1995	-	2001
DODGE	STRATUS	4 CIL. 2.0 L	1995	-	2000

**TCK219**



CHRYSLER	NEW YORKER	V6, 3.5 L	1994	-	1994
CHRYSLER	CONCORDE	V6, 3.5 L	1993	-	1994

**TCK246**



DODGE	NEON	4 CIL. 2.0 L	1995	-	1999
-------	------	--------------	------	---	------

**TCK224**



HONDA	CIVIC	4 CIL. 1.6 L	1997	-	2000
-------	-------	--------------	------	---	------

**TCK249**



NISSAN	QUEST	V6, 3.0 L	1998	-	1998
NISSAN	FRONTIER	V6, 3.3 L	2002	-	2002

**TCK227**



HONDA	CIVIC	4 CIL. 1.6 L	1999	-	2000
-------	-------	--------------	------	---	------

NISSAN	FRONTIER	V6, 3.3 L	2003	-	2004
NISSAN	QUEST	V6, 3.0 L	1997	-	1997
NISSAN	MAXIMA	V6, 3.0 L	1993	-	1994
NISSAN	XTERRA	V6, 3.3 L	2000	-	2001
NISSAN	PATHFINDER	V6, 3.0 L	1995	-	1995
NISSAN	QUEST	6 CIL. 3.3 L	2002	-	2002
NISSAN	PATHFINDER	V6, 3.3 L	1997	-	2000
NISSAN	QUEST	V6, 3.3 L	1999	-	2001
NISSAN	FRONTIER	V6, 3.3 L	1999	-	2001
NISSAN	XTERRA	V6, 3.3 L	2002	-	2002

**TCK258**



FORD	CONTOUR	4 CIL. 2.0 L	1995	-	1997
MERCURY	MYSTIQUE	4 CIL. 2.0 L	1995	-	1997

**TCK259**



DODGE	STRATUS	V6, 3.0 L	2001	-	2003
CHRYSLER	SEBRING	V6, 2.5 L	1996	-	2000
DODGE	STRATUS	V6, 2.5 L	1995	-	2000
CHRYSLER	CIRRUS	V6, 2.5 L	1995	-	2000
CHRYSLER	SEBRING	V6, 3.0 L	2001	-	2004
MITSUBISHI	ECLIPSE	V6, 3.0 L	2004	-	2005

**TCK255**



CHRYSLER	NEW YORKER	V6, 3.5 L	1995	-	1995
CHRYSLER	CONCORDE	V6, 3.5 L	1995	-	1997
CHRYSLER	NEW YORKER	V6, 3.5 L	1996	-	1996
DODGE	INTREPID	V6, 3.5 L	1995	-	1997

**TCK257**



TOYOTA	CAMRY	V6, 3.0 L	2002	-	2002
TOYOTA	CAMRY	V6, 3.0 L	2001	-	2001
TOYOTA	SIENNA	V6, 3.0 L	2000	-	2003

**TCK260M**



VOLKSWAGEN	DERBY	4 CIL. 1.8 L	2008	-	2006
VOLKSWAGEN	DERBY	4 CIL. 1.8 L	2005	-	2005
VOLKSWAGEN	JETTA	4 CIL. 2.0 L	2000	-	1995
VOLKSWAGEN	POINTER	4 CIL. 1.8 L	1998	-	2008
VOLKSWAGEN	CABRIO	4 CIL. 2.0 L	2002	-	2002
VOLKSWAGEN	PASSAT	4 CIL. 2.0 L	1996	-	1995
VOLKSWAGEN	GOLF	4 CIL. 2.0 L	2000	-	1995

**TCK262**



VOLKSWAGEN	GOLF	4 CIL. 2.0 L	1995 - 2000
VOLKSWAGEN	JETTA	4 CIL. 2.0 L	1995 - 2000
VOLKSWAGEN	CABRIO	4 CIL. 2.0 L	1995 - 2002
VOLKSWAGEN	GTI	4 CIL. 2.0 L	1999 - 2000
VOLKSWAGEN	PASSAT	4 CIL. 2.0 L	1995 - 1996

**TCK276**



FORD	RANGER	4 CIL. 2.5 L	1998 - 2001
FORD	RANGER	4 CIL. 2.3 L	2001 - 2001
FORD	RANGER	4 CIL. 2.3 L	1995 - 2002

**TCK282M**



HYUNDAI	ATTITUDE	4 CIL. 1.6 L	2005 - 2010
---------	----------	--------------	-------------

**TCK262A**



VOLKSWAGEN	CABRIO	4 CIL. 2.0 L	1996 - 1996
------------	--------	--------------	-------------

**TCK283**



FORD	ESCORT	4 CIL. 2.0 L	1997 - 2002
FORD	FOCUS	4 CIL. 2.0 L	2001 - 2003
FORD	FOCUS	4 CIL. 2.0 L	2000 - 2004

**TCK271**



TOYOTA	4 RUNNER	V6, 3.4 L	2002 - 2002
--------	----------	-----------	-------------

**TCK285**



CADILLAC	CATERA	V6, 3.0 L	1998 - 1999
SAAB	9 - 5	V6, 3.0 L	2000 - 2003

**TCK273**



CHEVROLET	LUMINA	V6, 3.4 L	1996 - 1997
-----------	--------	-----------	-------------

SAAB ..... 9 - 5 ..... V6, 3.0 L ..... 2002 - 2003

**TCK285A**



CADILLAC ..... CATERA ..... V6, 3.0 L ..... 1999 - 2001

**TCK286**



HONDA ..... ACCORD ..... V6, 3.0 L ..... 1998 - 2001

**TCK287**



MITSUBISHI ..... ECLIPSE ..... V6, 3.8 L ..... 2007 - 2008

MITSUBISHI ..... ENDEAVOR ..... V6, 3.8 L ..... 2004 - 2007

MITSUBISHI ..... GALANT ..... V6, 3.8 L ..... 2005 - 2007

MITSUBISHI ..... GALANT ..... V6, 3.8 L ..... 2004 - 2004

MITSUBISHI ..... MONTERO SPORT ..... V6, 3.5 L ..... 2004 - 2004

**TCK294**



FORD ..... CONTOUR ..... 4 CIL. 2.0 L ..... 1998 - 1999

FORD ..... ESCORT ..... 4 CIL. 2.0 L ..... 1998 - 1999

FORD ..... ESCORT ..... 4 CIL. 2.0 L ..... 2000 - 2000

MERCURY ..... MYSTIQUE ..... 4 CIL. 2.0 L ..... 1999 - 2000

MERCURY ..... MYSTIQUE ..... 4 CIL. 2.0 L ..... 1998 - 1998

**TCK294A**



FORD ..... ESCORT ..... 4 CIL. 2.0 L ..... 1999 - 2002

FORD ..... CONTOUR ..... 4 CIL. 2.0 L ..... 1999 - 2000

FORD ..... FOCUS ..... 4 CIL. 2.0 L ..... 2000 - 2004

FORD ..... FOCUS ..... 4 CIL. 2.0 L ..... 2001 - 2001

FORD ..... FOCUS ..... 4 CIL. 2.0 L ..... 2002 - 2006

FORD ..... ZX2 ..... 4 CIL. 2.0 L ..... 2003 - 2003

MERCURY ..... MYSTIQUE ..... 4 CIL. 2.0 L ..... 1999 - 1999

MERCURY ..... MYSTIQUE ..... 4 CIL. 2.0 L ..... 2000 - 2000

**TCK294B**



FORD ..... ESCAPE ..... 4 CIL. 2.0 L ..... 2001 - 2002

**TCK295**



CHRYSLER ..... 300M ..... V6, 3.5 L ..... 1999 - 2002

DODGE ..... INTREPID ..... V6, 3.5 L ..... 2000 - 2002

CHRYSLER ..... CONCORDE ..... V6, 3.2 L ..... 1998 - 2001

DODGE	INTREPID	V6, 3.2 L	1998	-	2001
CHRYSLER	CONCORDE	V6, 3.5 L	2002	-	2002

**TCK295A**



DODGE	NITRO	V6, 4.0 L	2009	-	2010
DODGE	JOURNEY	V6, 3.5 L	2009	-	2010
CHRYSLER	TOWN & COUNTRY	V6, 4.0 L	2008	-	2010
CHRYSLER	300 C	V6, 3.5 L	2007	-	2009
DODGE	CHARGER	V6, 3.5 L	2009	-	2009

**TCK296**



VOLKSWAGEN	GOLF	4 CIL. 2.0 L	1999	-	2005
VOLKSWAGEN	BEETLE	4 CIL. 2.0 L	1998	-	2005
VOLKSWAGEN	JETTA	4 CIL. 2.0 L	1999	-	2005
VOLKSWAGEN	BEETLE	4 CIL. 2.0 L	2003	-	2003
SEAT	IBIZA	4 CIL. 2.0 L	2003	-	2009
VOLKSWAGEN	JETTA	4 CIL. 2.0 L	2007	-	2010
VOLKSWAGEN	JETTA	4 CIL. 2.0 L	2006	-	2006
SEAT	CORDOBA	4 CIL. 2.0 L	2003	-	2007
VOLKSWAGEN	GOLF	4 CIL. 2.0 L	2006	-	2006

**TCK297**



AUDI	A8	V8, 4.2 L	2007	-	2007
------	----	-----------	------	---	------

**TCK298**



TOYOTA	TUNDRA	V8, 4.7 L	2007	-	2008
--------	--------	-----------	------	---	------

TOYOTA	LAND CRUISER	V8, 4.7 L	2007	-	2007
--------	--------------	-----------	------	---	------

**TCK305M**



CHEVROLET	ZAFIRA	4 CIL. 2.4 L	2004	-	2006
-----------	--------	--------------	------	---	------

CHEVROLET	ASTRA	4 CIL. 2.4 L	2004	-	2006
-----------	-------	--------------	------	---	------

**TCK306**



AUDI	A4	4 CIL. 1.8 L	2006	-	2006
------	----	--------------	------	---	------

**TCK309M**



CHEVROLET	OPTRA	4 CIL. 2.0 L	2006	-	2010
-----------	-------	--------------	------	---	------

CHEVROLET	OPTRA	4 CIL. 2.0 L	2006	-	2010
-----------	-------	--------------	------	---	------

**TCK321**



VOLKSWAGEN	JETTA	4 CIL. 1.9 L DIESEL	2000	-	2004
------------	-------	---------------------	------	---	------

**TCK330**



AUDI	A4	V6, 3.0 L	2006	-	2006
------	----	-----------	------	---	------

**TCK324M**



HYUNDAI	VERNA	4 CIL. 1.5 L	2004	-	2006
---------	-------	--------------	------	---	------

**TCK331**



VOLVO	C30	5 CIL. 2.4 L	2008	-	2010
VOLVO	C30	5 CIL. 2.5 L	2008	-	2010
VOLVO	S40	5 CIL. 2.5 L	2007	-	2008
VOLVO	XC90	5 CIL. 2.5 L	2003	-	2006
VOLVO	S40	5 CIL. 2.4 L	2005	-	2008

**TCK329**



ACURA	TSX	V6, 3.5 L	2010	-	2010
HONDA	PILOT	V6, 3.5 L	2008	-	2010
ACURA	RL	V6, 3.5 L	2006	-	2008
ACURA	TL	V6, 3.7 L	2009	-	2010
HONDA	ACCORD	V6, 3.5 L	2008	-	2010
ACURA	RL	V6, 3.7 L	2009	-	2010
HONDA	ODYSSEY	V6, 3.5 L	2008	-	2010
ACURA	TL	V6, 3.5 L	2008	-	2010
HONDA	RIDGELINE	V6, 3.5 L	2008	-	2010
ACURA	TL	V6, 3.2 L	2006	-	2008
ACURA	MDX	V6, 3.5 L	2006	-	2006
ACURA	MDX	V6, 3.7 L	2007	-	2010

**TCK333M**



VOLKSWAGEN	BORA	1.9 L DIESEL	2008	-	2010
VOLKSWAGEN	JETTA	1.9 L DIESEL	2004	-	2007
VOLKSWAGEN	EUROVAN	1.9 L DIESEL	2005	-	2009

**TCK335**



CHEVROLET	AVEO	4 CIL. 1.6 L	2009	-	2009
SUZUKI	SWIFT	4 CIL. 1.6 L	2008	-	2008

**TCK739M**



VOLKSWAGEN	EUROVAN	5 CIL. 2.5 L	2000	-	2004
------------	---------	--------------	------	---	------

**TCK901AM**



PEUGEOT	206	4 CIL. 1.4 L	2002	-	2008
PEUGEOT	206	4 CIL. 1.4 L	2002	-	2008

**TCK901M**



PEUGEOT	206	4 CIL. 1.4 L	1998	-	2001
PEUGEOT	206	4 CIL. 1.4 L	1998	-	2001

**TCKWP077**



NISSAN	TSURU	4 CIL. 1.6 L	1984	-	1997
--------	-------	--------------	------	---	------

**TCKWP1095M**



RENAULT	CLIO	4 CIL. 1.6 L	2003	-	2009
RENAULT	KANGOO	4 CIL. 1.6 L	2003	-	2010
NISSAN	APRIO	4 CIL. 1.6 L	2008	-	2010
NISSAN	PLATINA	4 CIL. 1.6 L	2002	-	2010

**TCKWP139**



DODGE	SPIRIT	V6, 3.0 L	1989	-	1995
DODGE	CARAVAN	V6, 3.0 L	1987	-	2000
HYUNDAI	SONATA	V6, 3.0 L	1987	-	2000
DODGE	STEALTH	V6, 3.0 L	1991	-	1996
CHRYSLER	LEBARON	V6, 3.0 L	1990	-	1995
PLYMOUTH	VOYAGER	V6, 3.0 L	1987	-	2000

**TCKWP143**



HONDA	CIVIC	4 CIL. 1.5 L	1988	-	1991
HONDA	CRX	4 CIL. 1.5 L	1988	-	1990



**TCKWP157**



LEXUS	ES250	V6, 2.5 L	1990 - 1991
TOYOTA	CAMRY	V6, 2.5 L	1988 - 1991

**TCKWP184A**



ACURA	INTEGRA	4 CIL. 1.8 L	1990 - 1995
-------	---------	--------------	-------------

**TCKWP163**



PONTIAC	SUNBIRD	4 CIL. 2.0 L	1990 - 1994
---------	---------	--------------	-------------

**TCKWP186**



HONDA	ODYSSEY	4 CIL. 2.2 L	1997 - 1997
ISUZU	OASIS	4 CIL. 2.2 L	1996 - 1997
HONDA	ACCORD	4 CIL. 2.2 L	1990 - 1997
HONDA	PRELUDE	4 CIL. 2.2 L	1990 - 1996

**TCKWP172**



SUBARU	LEGACY	4 CIL. 2.2 L	1990 - 1993
--------	--------	--------------	-------------

**TCKWP193**



ACURA	LEGEND	V6, 3.2 L	1991 - 1995
-------	--------	-----------	-------------

**TCKWP184**



HONDA	CR-V	4 CIL. 2.0 L	1997 - 2001
ACURA	INTEGRA	4 CIL. 1.8 L	1997 - 2001

**TCKWP193A**



ACURA	TL	V6, 3.2 L	1996 - 1998
-------	----	-----------	-------------

**TCKWP194**



FORD	ESCORT	4 CIL.1.9 L	1991 - 1996
MERCURY	TRACER	4 CIL.1.9 L	1991 - 1996

**TCKWP200**



LEXUS	ES300	V6, 3.0 L	1992 - 1993
TOYOTA	CAMRY	V6, 3.0 L	1992 - 1993

**TCKWP195**



DODGE	STEALTH	V6, 3.0 L	1991 - 1996
MITSUBISHI	DIAMANTE	V6, 3.0 L	1992 - 1995
MITSUBISHI	3000GT	V6, 3.0 L	1991 - 1999

**TCKWP203**



CHEVROLET	CHEVY	4 CIL.1.6 L	1998 - 2010
-----------	-------	-------------	-------------

**TCKWP199**



TOYOTA	CAMRY	4 CIL. 2.2 L	1990 - 2001
TOYOTA	RAV 4	4 CIL. 2.2 L	1990 - 2001
TOYOTA	CAMRY	4 CIL. 2.0 L	1990 - 2001
TOYOTA	CELICA	4 CIL. 2.2 L	1990 - 2001
TOYOTA	MR2	4 CIL. 2.0 L	1990 - 2001
TOYOTA	RAV 4	4 CIL. 2.0 L	1990 - 2001
TOYOTA	CELICA	4 CIL. 2.0 L	1990 - 2001
TOYOTA	MR2	4 CIL. 2.2 L	1990 - 2001

**TCKWP211**



ACURA	TL	5 CIL. 2.5 L	1995 - 1998
-------	----	--------------	-------------

**TCKWP211A**



ACURA	VIGOR	5 CIL. 2.5 L	1992 - 1994
-------	-------	--------------	-------------

**TCKWP216**



HONDA	PRELUDE	4 CIL. 2.3 L	1992 - 1996
-------	---------	--------------	-------------

**TCKWP224A**



HONDA	CIVIC	4 CIL. 1.6 L	1992 - 1995
HONDA	CIVIC DEL SOL	4 CIL. 1.6 L	1992 - 1995

**TCKWP219**



DODGE	INTREPID	V6, 3.5 L	1993 - 1994
-------	----------	-----------	-------------

**TCKWP240**



TOYOTA	4 RUNNER	V6, 3.0 L	1993 - 1995
TOYOTA	PICKUP	V6, 3.0 L	1993 - 1995

**TCKWP221**



ACURA	SLX	V6, 3.2 L	1996 - 1997
HONDA	PASSPORT	V6, 3.2 L	1994 - 1997
ISUZU	TROOPER	V6, 3.2 L	1992 - 1997
ISUZU	RODEO	V6, 3.2 L	1993 - 1997

**TCKWP240B**



TOYOTA	PICKUP	V6, 3.0 L	1994 - 1995
--------	--------	-----------	-------------

**TCKWP224**



ACURA	EL	4 CIL. 1.6 L	1997 - 2000
HONDA	CIVIC	4 CIL. 1.6 L	1996 - 2000

**TCKWP240C**



TOYOTA	4 RUNNER	V6, 3.0 L	1989 - 1992
--------	----------	-----------	-------------

**TCKWP244**



HONDA	ACCORD	4 CIL. 2.3 L	1998 - 2002
-------	--------	--------------	-------------

**TCKWP246**



CHRYSLER	SEBRING	4 CIL. 2.0 L	1995 - 1999
DODGE	NEON	4 CIL. 2.0 L	1995 - 1999
MITSUBISHI	ECLIPSE	4 CIL. 2.0 L	1995 - 1999

**TCKWP245**



DODGE	NEON	4 CIL. 2.0 L	1995 - 1998
DODGE	STRATUS	4 CIL. 2.0 L	1995 - 1998
PLYMOUTH	BREEZE	4 CIL. 2.0 L	1995 - 1998
PLYMOUTH	NEON	4 CIL. 2.0 L	1995 - 1998

**TCKWP259**



DODGE	SEBRING	V6, 3.0 L	2001 - 2005
DODGE	STRATUS	V6, 3.0 L	2001 - 2005
MITSUBISHI	GALANT	V6, 3.0 L	2001 - 2005
MITSUBISHI	ECLIPSE	V6, 3.0 L	2001 - 2005

**TCKWP245A**



DODGE	STRATUS	4 CIL. 2.0 L	1996 - 2005
DODGE	NEON	4 CIL. 2.0 L	1996 - 2005

**TCKWP259A**



DODGE	STRATUS	V6, 2.5 L	1995 - 2000
CHRYSLER	CIRRUS	V6, 2.5 L	1995 - 2000
MITSUBISHI	MONTERO SPORT	V6, 2.5 L	1995 - 2000

**TCKWP245B**



DODGE	NEON	4 CIL. 2.0 L	1996 - 2005
DODGE	STRATUS	4 CIL. 2.0 L	1996 - 2005

**TCKWP260**



VOLKSWAGEN	POINTER	4 CIL. 1.8 L	1998	-	2008
------------	---------	--------------	------	---	------

**TCKWP263**



HONDA	ACCORD	V6, 2.7 L	1995	-	1997
-------	--------	-----------	------	---	------

**TCKWP265**



DODGE	STRATUS	4 CIL. 2.4 L	2003	-	2006
JEEP	TJ	4 CIL. 2.4 L	2003	-	2006
DODGE	SEBRING	4 CIL. 2.4 L	2003	-	2006
JEEP	LIBERTY	4 CIL. 2.4 L	2003	-	2006
JEEP	WRANGLER	4 CIL. 2.4 L	2003	-	2006
CHRYSLER	PT CRUISER	4 CIL. 2.4 L	2003	-	2010
DODGE	CARAVAN	4 CIL. 2.4 L	2003	-	2007

**TCKWP265A**



CHRYSLER	PT CRUISER	4 CIL. 2.4 L	2003	-	2010
JEEP	TJ	4 CIL. 2.4 L	2003	-	2006
DODGE	STRATUS	4 CIL. 2.4 L	2003	-	2006
JEEP	LIBERTY	4 CIL. 2.4 L	2003	-	2006
DODGE	CARAVAN	4 CIL. 2.4 L	2003	-	2007
JEEP	WRANGLER	4 CIL. 2.4 L	2003	-	2006
DODGE	SEBRING	4 CIL. 2.4 L	2003	-	2006

**TCKWP265B**



DODGE	CARAVAN	4 CIL. 2.4 L	1997	-	2002
CHRYSLER	VOYAGER	4 CIL. 2.4 L	1997	-	2002
DODGE	STRATUS	4 CIL. 2.4 L	1997	-	2002

**TCKWP265C**



DODGE	NEON	4 CIL. 2.4 L	2003	-	2006
-------	------	--------------	------	---	------

**TCKWP279**



ACURA	RL	V6, 3.5 L	1996	-	2004
-------	----	-----------	------	---	------

**TCKWP281**



KIA	SPORTAGE	4 CIL. 2.0 L	1995 - 2002
-----	----------	--------------	-------------

**TCKWP296**



VOLKSWAGEN	GOLF	4 CIL. 2.0 L	1999 - 2008
VOLKSWAGEN	JETTA	4 CIL. 2.0 L	1999 - 2008
VOLKSWAGEN	BEETLE	4 CIL. 2.0 L	1998 - 2005

**TCKWP283**



FORD	FOCUS	4 CIL. 2.0 L	2000 - 2004
------	-------	--------------	-------------

**TCKWP297**



AUDI	A4	V6, 2.8 L	1998 - 2001
AUDI	A6	V6, 2.8 L	1998 - 2001
VOLKSWAGEN	PASSAT	V6, 2.8 L	1998 - 2005

**TCKWP283A**



FORD	ESCORT	4 CIL. 2.0 L	1997 - 2002
MERCURY	TRACER	4 CIL. 2.0 L	1997 - 1999

**TCKWP297A**



**TCKWP287**



MITSUBISHI	DIAMANTE	V6, 3.5 L	2000 - 2004
MITSUBISHI	ENDEAVOR	V6, 3.5 L	2004 - 2005

AUDI	A8	V8, 4.2 L	2001 - 2008
AUDI	A6	V8, 4.2 L	2000 - 2004
VOLKSWAGEN	TOUAREG	V8, 4.2 L	2004 - 2006

**TCKWP297B**



AUDI ..... ALLROAD QUATTR V6, 2.7 L ..... 2002 - 2005

**TCKWP306**



AUDI	TT	4 CIL. 1.8 L	2000 - 2005
VOLKSWAGEN	BEETLE	4 CIL. 1.8 L	1999 - 2005
VOLKSWAGEN	GOLF	4 CIL. 1.8 L	2000 - 2006
VOLKSWAGEN	JETTA	4 CIL. 1.8 L	2000 - 2006

**TCKWP306A**



AUDI	A4	4 CIL. 1.8 L	1999 - 2005
VOLKSWAGEN	PASSAT	4 CIL. 1.8 L	2001 - 2005

**TCKWP321**



VOLKSWAGEN	JETTA	4 CIL. 1.9 L DIESEL	1999 - 2003
VOLKSWAGEN	BEETLE	4 CIL. 1.9 L DIESEL	1998 - 2004
VOLKSWAGEN	GOLF	4 CIL. 1.9 L DIESEL	1999 - 2004

**TCKWP329**



ACURA	TL	V6, 3.5 L	2007 - 2012
HONDA	ACCORD	V6, 3.5 L	2008 - 2011
ACURA	TL	4 CIL. 3.2 L	2004 - 2008
HONDA	PILOT	V6, 3.5 L	2005 - 2011
HONDA	ODYSSEY	V6, 3.5 L	2005 - 2011
HONDA	ACCORD	V6, 3.0 L	2003 - 2007
HONDA	RIDGELINE	V6, 3.5 L	2005 - 2011
SATURN	VUE	V6, 3.5 L	2004 - 2007

**TCKWP331**



VOLVO	S60	5 CIL. 2.4 L	2001 - 2009
VOLVO	V40	5 CIL. 2.3 L	2002 - 2004
VOLVO	S60	5 CIL. 2.5 L	2003 - 2009
VOLVO	S60	5 CIL. 2.3 L	2001 - 2001
VOLVO	XC90	5 CIL. 2.5 L	2003 - 2006
VOLVO	V40	4 CIL. 1.9 L	2000 - 2004
VOLVO	C70	5 CIL. 2.3 L	1998 - 2004
VOLVO	C70	5 CIL. 2.4 L	1998 - 2004
VOLVO	S40	4 CIL. 1.9 L	2000 - 2004
VOLVO	S70	5 CIL. 2.3 L	1998 - 2000
VOLVO	V70	5 CIL. 2.3 L	1998 - 2004
VOLVO	S70	5 CIL. 2.4 L	1998 - 2000

**TENSORES Y POLEAS**

**36026**

Acero D.E. 70mm D.B. 12mm A - 30mm V-Ranurada



TOYOTA	SEQUOIA	V8, 4.7 L	2007	-	2008
TOYOTA	4 RUNNER	V8, 4.7 L	2003	-	2005
TOYOTA	TUNDRA	V8, 4.7 L	2007	-	2008
TOYOTA	4 RUNNER	V8, 4.7 L	2006	-	2007
TOYOTA	LAND CRUISER	V8, 4.7 L	2003	-	2006

**36086**

Acero Lisa/Posterior (78 mm x 12 mm x 20 mm)



HYUNDAI	ACCENT	4 CIL. 1.5 L	2003	-	2003
HYUNDAI	ATTITUDE	4 CIL. 1.6 L	2006	-	2007
HYUNDAI	ATTITUDE	4 CIL. 1.6 L	2008	-	2010
HYUNDAI	ATTITUDE	4 CIL. 1.4 L	2008	-	2010

**36087**

Acero D.E. 78mm D.B. 12mm A - 20mm Lisa

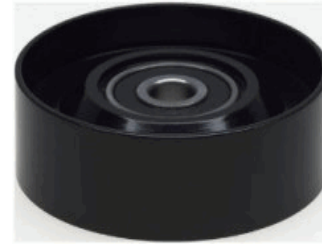

NISSAN	ALTIMA	V6, 3.5 L	2004	-	2006
NISSAN	MAXIMA	V6, 3.5 L	2004	-	2004
NISSAN	MURANO	V6, 3.5 L	2003	-	2004
NISSAN	QUEST	V6, 3.5 L	2007	-	2007
NISSAN	MURANO	6 CIL. 3.5 L	2006	-	2006
NISSAN	QUEST	V6, 3.5 L	2008	-	2009
NISSAN	QUEST	6 CIL. 3.5 L	2006	-	2006
NISSAN	MAXIMA	V6, 3.5 L	2002	-	2005
NISSAN	ALTIMA	V6, 3.5 L	2002	-	2003

**36060**



BMW	318IS	4 CIL. 1.8 L	1993	-	1991
BMW	318I	4 CIL. 1.8 L	1993	-	1991

**36079**

Termoplástico V-Ranurada 6 costillas (60 mm x 17 mm x 25 mm) - , c/ tornillo, Cubre Polvo, Rondana



SAAB	9-5	V6, 3.0 L	2003	-	2003
SAAB	9-3	4 CIL. 2.0 L	2002	-	2002
SAAB	9-5	4 CIL. 2.3 L	2002	-	2007

**36094**

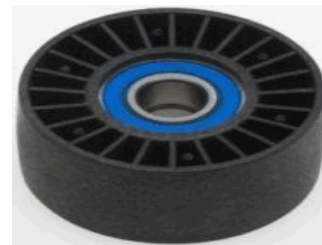

DODGE	RAM SERIES PICK	6 CIL. 5.9 L	2002	-	2002
-------	-----------------	--------------	------	---	------



**36099**

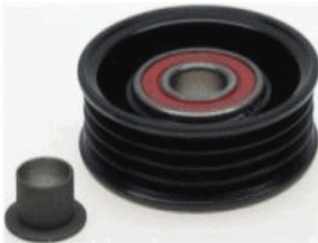

GMC	CANYON	5 CIL. 3.7 L	2009	-	2010
GMC	CANYON	5 CIL. 3.7 L	2007	-	2008
CHEVROLET	TRAILBLAZER	6 CIL. 4.2 L	2002	-	2007
HUMMER	H3	5 CIL. 3.7 L	2008	-	2010

HONDA	PASSPORT	V6, 3.2 L	1997	-	1997
-------	----------	-----------	------	---	------

**36100**

Acero D.E. 76mm D.B. 17mm A - 29.5mm V-Ranurada



CHRYSLER	CONCORDE	V6, 2.7 L	1998	-	2003
FORD	MUSTANG	V8, 4.6 L	2000	-	2004
DODGE	INTREPID	V6, 2.7 L	1998	-	2003
LINCOLN	TOWN CAR	V8, 4.6 L	2006	-	2006
LINCOLN	TOWN CAR	V8, 4.6 L	2001	-	2004
MERCURY	GRAND MARQUIS	V8, 4.6 L	2003	-	2004

**36101**

Acero D.E. 70mm D.B. 17mm A - 31mm Lisa



CHEVROLET	COLORADO	5 CIL. 3.7 L	2007	-	2007
CHEVROLET	COLORADO	5 CIL. 3.7 L	2008	-	2010
GMC	ENVOY	6 CIL. 4.2 L	2007	-	2002
CHEVROLET	COLORADO	5 CIL. 3.5 L	2004	-	2006
CHEVROLET	COLORADO	4 CIL. 2.9 L	2007	-	2007
GMC	CANYON	4 CIL. 2.9 L	2007	-	2007
HUMMER	H3	5 CIL. 3.5 L	2006	-	2007
CHEVROLET	COLORADO	4 CIL. 2.9 L	2008	-	2010
CHEVROLET	COLORADO	4 CIL. 2.8 L	2005	-	2006

**36103**



DODGE	D & W SERIES PICI	6 CIL. 3.7 L	1987	-	1987
CHRYSLER	FIFTH AVENUE	V8, 5.2 L	1989	-	1985
DODGE	DIPLOMAT	V8, 5.2 L	1989	-	1985
DODGE	RAM CHARGER	V8, 5.2 L	1991	-	1986
DODGE	RAM CHARGER	V8, 5.9 L	1992	-	1986
DODGE	D & W SERIES PICI	V8, 5.2 L	1991	-	1986
DODGE	D & W SERIES PICI	V8, 5.9 L	1992	-	1986
DODGE	B SERIES VAN	V8, 5.9 L	1992	-	1986
DODGE	DAKOTA	V6, 3.9 L	1991	-	1987
DODGE	D & W SERIES PICI	V6, 3.9 L	1991	-	1988
DODGE	B SERIES VAN	V6, 3.9 L	1991	-	1988
DODGE	B SERIES VAN	6 CIL. 3.7 L	1987	-	1987
DODGE	B SERIES VAN	V8, 5.2 L	1991	-	1986
PLYMOUTH	GRAN FURY	V8, 5.2 L	1989	-	1985

**36105**

Termoplástico Lisa/Posterior (73 mm x 17 mm x 21.8 mm) - c/ Bracket



VOLKSWAGEN	BORA	5 CIL. 2.5 L	2005	-	2009
VOLKSWAGEN	BORA SPORTWAG	5 CIL. 2.5 L	2008	-	2009
VOLKSWAGEN	BEETLE	5 CIL. 2.5 L	2009	-	2010

**36106**

Termoplástico Lisa/Posterior (65 mm x 17 mm x 21.8 mm) - c/ Bracket



VOLKSWAGEN	BORA SPORTWAG	5 CIL. 2.5 L	2008	-	2009
VOLKSWAGEN	BORA	5 CIL. 2.5 L	2005	-	2009

**36115**

Acero D.E. 83.5mm D.B. 12mm A - 18mm Lisa



NISSAN	MAXIMA	V6, 3.0 L	2004	-	2004
NISSAN	MAXIMA	V6, 3.0 L	1993	-	1994

**36112**

Acero D.E. 76.3mm D.B. 17mm A - 29.5mm Lisa



ACURA	TL	V6, 3.5 L	2008	-	2010
ACURA	TSX	V6, 3.5 L	2010	-	2010
HONDA	ODYSSEY	V6, 3.5 L	2008	-	2010
ACURA	MDX	V6, 3.5 L	2006	-	2006
HONDA	RIDGELINE	V6, 3.5 L	2008	-	2010
ACURA	RL	V6, 3.5 L	2008	-	2008
ACURA	TL	V6, 3.7 L	2009	-	2010
HONDA	ACCORD	V6, 3.0 L	2005	-	2006
HONDA	PILOT	V6, 3.5 L	2005	-	2007
ACURA	MDX	V6, 3.7 L	2007	-	2007
HONDA	PILOT	V6, 3.5 L	2006	-	2006
HONDA	PILOT	V6, 3.5 L	2008	-	2008
ACURA	RL	V6, 3.5 L	2006	-	2007
ACURA	RL	V6, 3.7 L	2009	-	2010
ACURA	TL	V6, 3.2 L	2006	-	2007
ACURA	MDX	V6, 3.7 L	2008	-	2010
HONDA	ODYSSEY	V6, 3.5 L	2006	-	2007
HONDA	RIDGELINE	V6, 3.5 L	2006	-	2007
HONDA	ACCORD	V6, 3.0 L	2003	-	2007
HONDA	ODYSSEY	V6, 3.5 L	2005	-	2005
ACURA	TL	V6, 3.2 L	2008	-	2008

**36116**

Acero D.E. 100mm D.B. 17mm A - 18.8mm V-Ranurada



NISSAN	XTERRA	4 CIL. 2.4 L	2000	-	2001
NISSAN	FRONTIER	4 CIL. 2.4 L	1999	-	2001

**36118**

Acero D.E. 80mm D.B. 17mm A - 25mm V-Ranurada



NISSAN	PATHFINDER	V6, 3.0 L	1995	-	1995
--------	------------	-----------	------	---	------

**36119**

Acero D.E. 102mm D.B. 17mm A - 26mm Lisa



TOYOTA	LAND CRUISER	V8, 4.7 L	2003	-	2006
TOYOTA	SEQUOIA	V8, 4.7 L	2007	-	2008
TOYOTA	4 RUNNER	V8, 4.7 L	2003	-	2005
TOYOTA	4 RUNNER	V8, 4.7 L	2006	-	2007

**36136**

Acero Polea Ranurada 6 costillas (72mm x 15mm x 26mm)



FORD	KA	4 CIL. 1.6 L	2005	-	2005
------	----	--------------	------	---	------

**36156**

Termoplástico D.E. 70mm D.B. 17mm A - 19mm Lisa



CHRYSLER	PT CRUISER	4 CIL. 2.4 L	2008	-	2010
DODGE	NEON	4 CIL. 2.0 L	2004	-	2006
CHRYSLER	PT CRUISER	4 CIL. 2.4 L	2008	-	2010
DODGE	NEON	4 CIL. 2.0 L	2004	-	2006
TOYOTA	CAMRY	4 CIL. 2.5 L	2010	-	2011
TOYOTA	CAMRY	4 CIL. 2.5 L	2010	-	2011

**36142**

Acero D.E. 83.5mm D.B. 17mm\*\* A - 30mm Lisa



NISSAN	SENTRA	4 CIL. 1.8 L	2006	-	2006
--------	--------	--------------	------	---	------

**36152**

Acero D.E. 70mm D.B. 17mm A - 20.5mm Lisa



CHEVROLET	CHEVY C2	4 CIL. 1.6 L	2004	-	2008
CHEVROLET	OPTRA	4 CIL. 2.0 L	2006	-	2008
CHEVROLET	CHEVY PICK-UP	4 CIL. 1.6 L	2002	-	2006
CHEVROLET	CHEVY JOY	4 CIL. 1.6 L	1994	-	1998
CHEVROLET	CHEVY	4 CIL. 1.6 L	2009	-	2010
CHEVROLET	CHEVY POP	4 CIL. 1.6 L	1994	-	2003
CHEVROLET	OPTRA	4 CIL. 2.0 L	2006	-	2010
CHEVROLET	CHEVY C2 SEDAN	4 CIL. 1.6 L	2004	-	2008
CHEVROLET	CHEVY SWING	4 CIL. 1.6 L	1994	-	2003

**36157**

Acero D.E. 87mm D.B. 17mm A - 31mm V-Ranurada



FORD	F-450 SUPER DUTY	V10, 6.8 L	2007	-	2007
FORD	E SERIES VAN	V8, 5.4 L	2008	-	2010
FORD	LOBO	V8, 4.6 L	2005	-	2006
FORD	LOBO	V8, 5.4 L	2008	-	2010
FORD	LOBO	V8, 4.6 L	2008	-	2010
FORD	LOBO	V8, 5.4 L	2005	-	2007
FORD	MUSTANG	V8, 4.6 L	2008	-	2010
FORD	EXPEDITION	V8, 5.4 L	2005	-	2010
FORD	E SERIES VAN	V8, 4.6 L	2008	-	2010
FORD	F-150	V8, 4.6 L	2008	-	2010
FORD	EXPLORER SPORT	V8, 4.6 L	2007	-	2010
FORD	EXPLORER	V8, 4.6 L	2007	-	2010
FORD	F-350 SUPER DUTY	V8, 5.4 L	2007	-	2009
FORD	MUSTANG	V8, 4.6 L	2006	-	2007
LINCOLN	MARK LT	V8, 5.4 L	2007	-	2008
LINCOLN	AVIATOR	V8, 4.6 L	2003	-	2005
LINCOLN	NAVIGATOR	V8, 5.4 L	2008	-	2009

**36168**

Acero Lisa/Posterior (70 mm x 17 mm x 26 mm) - c/ tornillo, Cubre Polvo, Espaciador



MINI	COOPER	4 CIL. 1.6 L	2005	-	2008
------	--------	--------------	------	---	------

**36173**

Acero Lisa/Posterior (70 mm x 17 mm x 33 mm) - c/ 10 mm Buje



TOYOTA	RAV 4	V6, 3.5 L	2008	-	2010
TOYOTA	HIGHLANDER	V6, 3.5 L	2008	-	2010
TOYOTA	SIENNA	V6, 3.5 L	2007	-	2011
TOYOTA	CAMRY	V6, 3.5 L	2009	-	2011
TOYOTA	TACOMA	V6, 4.0 L	2009	-	2010

**36169**

Acero D.E. 60mm D.B. 12mm A - 21.25mm Lisa



GMC	YUKON	V8, 6.2 L	2007	-	2008
CHEVROLET	EXPRESS	V8, 5.3 L	2008	-	2008
CADILLAC	ESCALADE	V8, 6.2 L	2007	-	2007
GMC	YUKON	V8, 5.3 L	2007	-	2008
CADILLAC	ESCALADE	V8, 6.2 L	2008	-	2008
CHEVROLET	AVALANCHE	V8, 5.3 L	2007	-	2007
CHEVROLET	SILVERADO	V8, 5.3 L	2008	-	2008
CHEVROLET	AVALANCHE	V8, 5.3 L	2008	-	2008
CHEVROLET	TAHOE	V8, 5.3 L	2008	-	2008
CHEVROLET	EXPRESS	V8, 6.0 L	2008	-	2008
CHEVROLET	SUBURBAN	V8, 5.3 L	2008	-	2008
CHEVROLET	TAHOE	V8, 4.8 L	2006	-	2007
HUMMER	H2	V8, 6.2 L	2008	-	2008
GMC	SIERRA	V8, 6.2 L	2007	-	2008
CHEVROLET	SUBURBAN	V8, 6.0 L	2008	-	2008
CHEVROLET	SILVERADO	V8, 4.8 L	2008	-	2008

**36174**

Acero Lisa/Posterior (70 mm x 17 mm x 33 mm) - c/ 10 mm Inserto, Tornillo, Cubre Polvo



TOYOTA	TACOMA	V6, 4.0 L	2009	-	2010
--------	--------	-----------	------	---	------

**36193**

Termoplástico Lisa/Posterior (82 mm x 17 mm x 22 mm) - c/ Cubre Polvo



CHEVROLET	CAPTIVA	4 CIL. 2.4 L	2009	-	2010
CHEVROLET	MALIBU	4 CIL. 2.4 L	2008	-	2010
CHEVROLET	HHR	4 CIL. 2.4 L	2009	-	2010

**36201**

Acero Lisa/Posterior (76 mm x 17 mm x 38 mm) - c/ tornillo, 2 Cubre Polvos, Inserto



CHEVROLET UPLANDER V6, 3.9 L 2008 - 2009

**36222**

Acero V-Ranurada 7 costillas (72 mm x 17 mm x 28 mm) - c/ 10 mm Buje



NISSAN ARMADA V8, 5.6 L 2006 - 2009

NISSAN TITAN V8, 5.6 L 2009 - 2009

NISSAN PATHFINDER V6, 4.0 L 2008 - 2010

**36234**

Acero Lisa/Posterior (90 mm x 17 mm x 39.5 mm)



FORD F-550 SUPER DUTY V8, 6.4 L DIESEL 2008 - 2010

FORD F-250 SUPER DUTY V8, 6.4 L DIESEL 2008 - 2010

FORD F-450 SUPER DUTY V8, 6.4 L DIESEL 2008 - 2010

**36263**

Acero Lisa/Posterior (70 mm x 17 mm x 26 mm) - c/ tornillo, Cubre Polvo, Retenedor, Espaciador



MAZDA CX-7 4 CIL. 2.3 L 2006 - 2008

**36271**

Acero Lisa/Posterior (76 mm x 10 mm x 22 mm) - c/ Espaciador, Rondana



MITSUBISHI ECLIPSE V6, 3.8 L 2007 - 2008

**36299**

Acero Lisa/Posterior (90 mm x 17 mm x 31 mm) - c/ tornillo, 17 mm Inserto, Cubre Polvo, Retenedor, Espaciador



CHEVROLET AVALANCHE V8, 5.3 L 2008 - 2010

CHEVROLET EXPRESS CARGO V6, 4.3 L 2008 - 2010

CHEVROLET SILVERADO V8, 4.8 L 2008 - 2010

CHEVROLET EXPRESS V8, 5.3 L 2008 - 2010

CHEVROLET TAHOE V8, 5.3 L 2008 - 2010

GMC SIERRA V8, 6.2 L 2009 - 2010

CHEVROLET SILVERADO V6, 4.3 L 2008 - 2010

GMC YUKON V8, 6.2 L 2009 - 2010

CHEVROLET SUBURBAN V8, 6.0 L 2008 - 2010

CHEVROLET EXPRESS V8, 6.0 L 2008 - 2010

CADILLAC ESCALADE V8, 6.2 L 2008 - 2010

CHEVROLET SILVERADO V8, 5.3 L 2008 - 2010

CHEVROLET SUBURBAN V8, 5.3 L 2008 - 2010

HUMMER H2 V8, 6.2 L 2008 - 2010

GMC SIERRA V8, 5.3 L 2009 - 2010

**36300**

Termoplástico Lisa/Posterior (65 mm x 17 mm x 26 mm) - c/ tornillo, 2 Cubre Polvos, Retenedor



AUDI A3 V6, 3.2 L 2007 - 2008

**36301**

Acero Lisa/Posterior (70 mm x 17 mm x 33.5 mm)



GMC	CANYON	5 CIL. 3.7 L	2009	-	2010
CHEVROLET	COLORADO	5 CIL. 3.7 L	2010	-	2009
HUMMER	H3	5 CIL. 3.7 L	2008	-	2010
CHEVROLET	COLORADO	4 CIL. 2.9 L	2010	-	2009

**36305**

Acero V-Ranurada 7 costillas (70 mm x 10 mm x 31 mm) - , c/ tornillo, 2 Cubre Polvos, 10 mm Buje



NISSAN	370Z	V6, 3.7 L	2009	-	2009
NISSAN	350Z	V6, 3.5 L	2007	-	2009

**36306**

Acero Lisa/Posterior (75 mm x 10 mm x 31 mm) - c/ tornillo, 2 Cubre Polvos, 10 mm Buje, Espaciador



NISSAN	350Z	V6, 3.5 L	2007	-	2009
--------	------	-----------	------	---	------

**36313**

Termoplástico Lisa/Posterior (70 mm x 17 mm x 24 mm)



DODGE	CHARGER	V6, 3.5 L	2009	-	2009
DODGE	RAM 2500	V8, 5.7 L	2009	-	2009
JEEP	GRAND CHEROKE	V8, 5.7 L	2008	-	2009
JEEP	COMMANDER	V8, 5.7 L	2009	-	2009
JEEP	GRAND CHEROKE	V8, 6.1 L	2008	-	2009
CHRYSLER	TOWN & COUNTRY	V6, 4.0 L	2008	-	2010
DODGE	JOURNEY	V6, 3.5 L	2009	-	2010
CHRYSLER	300 C	V6, 3.5 L	2007	-	2009
DODGE	CHARGER	V8, 5.7 L	2009	-	2009

VOLKSWAGEN	ROUTAN	V6, 3.8 L	2009	-	2010
------------	--------	-----------	------	---	------

**36315**

Acero V-Ranurada 8 costillas (123 mm x 17 mm x 34 mm)



DODGE	RAM 4000	V6, 6.7 L DIESEL	2008	-	2009
DODGE	RAM 4000	V6, 5.9 L DIESEL	2008	-	2008

**36320**

Acero V-Ranurada 7 costillas (76 mm x 17 mm x 29.5 mm) -



ACURA	TSX	4 CIL. 2.4 L	2009	-	2009
-------	-----	--------------	------	---	------

**37008P**



ACURA	RL	V6, 3.5 L	2006	-	2007
ACURA	RL	V6, 3.5 L	2008	-	2008
ACURA	MDX	V6, 3.7 L	2008	-	2010
ACURA	MDX	V6, 3.7 L	2007	-	2007
ACURA	MDX	V6, 3.5 L	2006	-	2006
ACURA	TL	V6, 3.2 L	2006	-	2007

**37010P**

Acero V-Ranurada 6 costillas (50 mm x 14.5 mm x 40.5 mm) - c/ Cubre Polvo



VOLKSWAGEN	JETTA	4 CIL. 1.9 L DIESEL	2000	-	2002
VOLKSWAGEN	GOLF	4 CIL. 1.9 L	1999	-	1999

**37014P**

Acero V-Ranurada 6 costillas (56 mm x 14.5 mm x 42.5 mm) - c/ Cubre Polvo



PORSCHE	911	6 CIL. 3.4 L	2000	-	2000
PORSCHE	BOXSTER	6 CIL. 2.7 L	2000	-	2006
PORSCHE	BOXSTER	6 CIL. 3.2 L	2000	-	2006

**37012P**



VOLKSWAGEN	BEETLE	4 CIL. 1.9 L	2001	-	2001
------------	--------	--------------	------	---	------

**37013P**

Acero V-Ranurada 6 costillas (52.5 mm x 14.5 mm x 35.5 mm) - c/ Cubre Polvo



AUDI	A3	4 CIL. 2.0 L	2006	-	2009
AUDI	A3	V6, 3.2 L	2007	-	2008
AUDI	TT	4 CIL. 1.8 L	2003	-	2003
VOLKSWAGEN	JETTA	4 CIL. 2.0 L	1999	-	2005
VOLKSWAGEN	JETTA	4 CIL. 1.8 L	2000	-	2005
VOLKSWAGEN	BEETLE	4 CIL. 2.0 L	1998	-	2003
VOLKSWAGEN	JETTA	4 CIL. 1.9 L DIESEL	2000	-	2004
VOLKSWAGEN	GOLF	4 CIL. 1.8 L	2000	-	2001
VOLKSWAGEN	BEETLE	4 CIL. 1.8 L	1999	-	2003
VOLKSWAGEN	GOLF	4 CIL. 2.0 L	2000	-	2003

**37015P**

Acero V-Ranurada 6 costillas (55 mm x 12.5 mm x 38.75 mm) - c/ Cubre Polvo



TOYOTA	COROLLA	4 CIL. 1.8 L	2009	-	2010
TOYOTA	MATRIX	4 CIL. 1.8 L	2009	-	2010

**37017P**

Acero V-Ranurada 7 costillas (56 mm x 17 mm x 50 mm) - c/ Cubre Polvo



TOYOTA	COROLLA	4 CIL. 2.4 L	2009	-	2010
TOYOTA	CAMRY	4 CIL. 2.4 L	2007	-	2009
TOYOTA	MATRIX	4 CIL. 2.4 L	2009	-	2010
TOYOTA	RAV 4	4 CIL. 2.4 L	2007	-	2008

**37018P**

Acero V-Ranurada 6 costillas (53 mm x 12.5 mm x 49 mm) - c/ Cubre Polvo



JEEP	PATRIOT	4 CIL. 2.4 L	2007 - 2010
DODGE	AVENGER	4 CIL. 2.0 L	2007 - 2009
DODGE	AVENGER	4 CIL. 2.4 L	2007 - 2009
DODGE	CALIBER	4 CIL. 2.4 L	2007 - 2009
JEEP	COMPASS	4 CIL. 2.4 L	2007 - 2010

JEEP	WRANGLER	4 CIL. 2.5 L	1999 - 2000
FORD	F-150	V8, 4.6 L	2008 - 2010
CHEVROLET	SILVERADO	V8, 4.8 L	2001 - 2002
FORD	EXPLORER	V6, 4.0 L	1995 - 2001
FORD	F-350 SUPER DUTY	V8, 5.4 L	2007 - 2010
FORD	ESCORT	4 CIL. 2.0 L	1997 - 2001
FORD	F-350 SUPER DUTY	V8, 5.4 L	2002 - 2006
FORD	EXPLORER	V8, 4.6 L	2007 - 2010
JEEP	GRAND CHEROKE	V6, 3.7 L	2005 - 2005
FORD	EXPLORER SPORT	V6, 4.0 L	2001 - 2006
CHEVROLET	EXPRESS CARGO	V6, 4.3 L	2007 - 2007
FORD	EXPLORER SPORT	V6, 4.0 L	2004 - 2005
GMC	SIERRA	V8, 6.2 L	2007 - 2008
FORD	EXPLORER SPORT	V8, 4.6 L	2007 - 2010
JEEP	GRAND CHEROKE	V6, 3.7 L	2006 - 2007
FORD	EXPLORER SPORT	V6, 4.0 L	2007 - 2010
CHRYSLER	VOYAGER	V6, 3.3 L	2000 - 2000
CHEVROLET	S-10	4 CIL. 2.2 L	1994 - 1994
GMC	SAVANA	V8, 8.1 L	2002 - 2001
FORD	F SERIES PICKUP	V6, 4.2 L	1999 - 2002
CHEVROLET	SILVERADO	V6, 4.3 L	2003 - 2007
FORD	AEROSTAR	V6, 4.0 L	1996 - 1997
CHEVROLET	SILVERADO	V6, 4.3 L	2001 - 2000
CHEVROLET	S-10	V6, 4.3 L	1993 - 1994
CHEVROLET	S-10	V6, 4.3 L	2002 - 1995
ACURA	CL	V6, 3.0 L	1999 - 1999
FORD	CONTOUR	4 CIL. 2.0 L	1995 - 1997
GMC	SAVANA	V8, 6.0 L	2007 - 2003
GMC	SAVANA	V8, 5.7 L	2002 - 2000
FORD	EXPLORER	V8, 5.0 L	1998 - 2001
GMC	SAVANA	V8, 5.3 L	2007 - 2003
GMC	SAVANA	V8, 5.0 L	2002 - 2000
FORD	EXPLORER	V6, 4.0 L	2005 - 2007
GMC	SAVANA	V8, 4.8 L	2007 - 2003
GMC	SAVANA	V8, 7.4 L	2000 - 2000
FORD	MUSTANG	V8, 4.6 L	2006 - 2007
CHEVROLET	SUBURBAN	V8, 5.3 L	2003 - 2004

**37026P**

Acero V-Ranurada 7 costillas (52.5 mm x 12.5 mm x 40.5 mm) - c/ Cubre Polvo



TOYOTA	HIGHLANDER	V6, 3.5 L	2008 - 2010
TOYOTA	SIENNA	V6, 3.5 L	2007 - 2011
TOYOTA	RAV 4	V6, 3.5 L	2008 - 2010
TOYOTA	CAMRY	V6, 3.5 L	2009 - 2011

**38001**

Acero D.E. 90mm D.B. 17mm A - 30mm Lisa



LINCOLN	LS	V6, 3.0 L	2001 - 2000
FORD	F-150	V6, 4.2 L	2008 - 2008
FORD	EXPLORER	V8, 4.6 L	2002 - 2004
GMC	JIMMY	V6, 4.3 L	2005 - 2000
GMC	SAFARI	V6, 4.3 L	2005 - 2000
FORD	EXPLORER	V8, 4.6 L	2005 - 2007
LINCOLN	LS	V8, 3.9 L	2000 - 2002
FORD	F SERIES PICKUP	V8, 7.5 L	1997 - 1997
JEEP	GRAND CHEROKE	V8, 4.7 L	2007 - 2007
FORD	F SERIES PICKUP	V8, 5.4 L	2002 - 2002
JEEP	GRAND CHEROKE	V8, 4.7 L	1999 - 2006
CHEVROLET	SILVERADO	V8, 4.8 L	2003 - 2007
FORD	F-150	V6, 4.2 L	2003 - 2006
GMC	SAVANA	V6, 4.3 L	2007 - 2000





FORD	SUPER DUTY VAN	V8, 4.6 L	2003	-	2003
FORD	EXPEDITION	V8, 5.4 L	2005	-	2010
FORD	SUPER DUTY VAN	V6, 4.2 L	2001	-	2001
CHEVROLET	SUBURBAN	V8, 5.3 L	2000	-	2007
CHEVROLET	SUBURBAN	V8, 5.7 L	1996	-	1995
FORD	RANGER	4 CIL. 2.3 L	2002	-	2004
CHEVROLET	TRAILBLAZER	V8, 5.3 L	2006	-	2006
CHEVROLET	SUBURBAN	V8, 6.0 L	2000	-	2007
FORD	EXCURSION	V8, 4.6 L	2003	-	2003
CHEVROLET	SUBURBAN	V8, 7.4 L	1993	-	1999
FORD	MUSTANG	V6, 4.0 L	2008	-	2010
JEEP	LIBERTY	V6, 3.7 L	2002	-	2006
CHEVROLET	S-10	4 CIL. 2.2 L	1995	-	1997
CHEVROLET	SILVERADO PICKU	V8, 8.1 L	2006	-	2007
CHEVROLET	TAHOE	V8, 4.8 L	2006	-	2007
FORD	SUPER DUTY PICK	V8, 5.4 L	2002	-	2003
FORD	MUSTANG	V6, 4.0 L	2007	-	2007
CHEVROLET	TRAILBLAZER	V8, 5.3 L	2005	-	2005
FORD	MUSTANG	V6, 4.0 L	2005	-	2006
FORD	RANGER	4 CIL. 2.5 L	1999	-	1998
CHEVROLET	TAHOE	V8, 5.3 L	2006	-	2007
FORD	EXPEDITION	V8, 4.6 L	2003	-	2004
FORD	MUSTANG	V8, 4.6 L	2008	-	2010
FORD	MUSTANG	V8, 4.6 L	2005	-	2005
FORD	RANGER	V6, 4.0 L	1999	-	2001
FORD	RANGER	V6, 3.0 L	2002	-	2002
CHEVROLET	SUBURBAN	V8, 8.1 L	2001	-	2006
CHEVROLET	SILVERADO	V8, 8.1 L	2003	-	2007
FORD	EXPLORER	V6, 4.0 L	2002	-	2004
FORD	RANGER	V6, 3.0 L	1999	-	2001
FORD	F-450 SUPER DUT	V10, 6.8 L	2007	-	2010
FORD	EXPLORER	V6, 4.0 L	2007	-	2010
CHEVROLET	VENTURE	V6, 3.4 L	1998	-	1998
FORD	F-450 SUPER DUT	V8, 7.5 L	1997	-	1997
FORD	F-550 SUPER DUT	V10, 6.8 L	2008	-	2010
FORD	EXPEDITION	V8, 5.4 L	2003	-	2003
CHEVROLET	SILVERADO	V8, 5.3 L	2003	-	2007

FORD	CONTOUR	V6, 2.5 L	1996	-	2000
FORD	LOBO	V8, 4.6 L	2008	-	2010
CHEVROLET	SILVERADO	V8, 5.3 L	2000	-	2002
CHEVROLET	TRAILBLAZER	V8, 5.3 L	2007	-	2007
CHEVROLET	SILVERADO	V8, 6.0 L	2000	-	2002
FORD	LOBO	V8, 5.4 L	2005	-	2007
FORD	MUSTANG	V8, 4.6 L	2003	-	2003
FORD	WINDSTAR	V6, 3.8 L	1998	-	2001
CHEVROLET	SILVERADO	V8, 8.1 L	2001	-	2002
FORD	WINDSTAR	V6, 3.8 L	2002	-	2003
FORD	ESCORT	4 CIL. 1.9 L	1994	-	1996
FORD	LOBO	V8, 4.6 L	2005	-	2006
CHEVROLET	SILVERADO PICKU	V6, 4.3 L	1999	-	2007
CHEVROLET	SILVERADO PICKU	V8, 4.8 L	2006	-	2005
FORD	LOBO	V8, 5.4 L	2008	-	2010
CHEVROLET	SILVERADO PICKU	V8, 5.3 L	2001	-	2007
CHEVROLET	SILVERADO PICKU	V8, 6.0 L	2003	-	2000
CHEVROLET	TRAILBLAZER	V8, 6.0 L	2006	-	2006
CHEVROLET	TRAILBLAZER	V8, 5.3 L	2003	-	2003
CHEVROLET	SILVERADO	V8, 6.0 L	2003	-	2007
DODGE	DURANGO	V8, 4.7 L	2006	-	2006
DODGE	DAKOTA	V6, 3.7 L	2007	-	2008
FORD	E SERIES VAN	V8, 4.6 L	2008	-	2010
FORD	E SERIES VAN	V8, 5.4 L	2002	-	2005
CADILLAC	ESCALADE	V8, 6.0 L	2006	-	2006
CADILLAC	ELDORADO	V8, 4.6 L	1994	-	1997
DODGE	NITRO	V6, 3.7 L	2007	-	2008
JAGUAR	S-TYPE	V8, 4.0 L	2003	-	2004
CHEVROLET	EXPRESS	V6, 4.3 L	1998	-	2003
CHEVROLET	EXPRESS	V8, 5.3 L	2003	-	2007
HONDA	ODYSSEY	V6, 3.5 L	2002	-	2002
GMC	ENVOY	V8, 5.3 L	2007	-	2003
CHEVROLET	EXPRESS	V8, 5.0 L	1996	-	2002
HONDA	ACCORD	V6, 3.0 L	1998	-	2001
CADILLAC	SEVILLE	V8, 4.6 L	1994	-	1997
CHEVROLET	EXPRESS	V8, 5.3 L	2004	-	2004
HONDA	ACCORD	V6, 3.0 L	2002	-	2002



CHEVROLET	LUMINA	V6, 3.1 L	1998	-	1998
CHEVROLET	C & K SERIES PICK	V8, 5.7 L	1993	-	2000
CHEVROLET	IMPALA	V6, 3.8 L	2005	-	2005
CHEVROLET	AVALANCHE	V8, 5.3 L	2005	-	2005
FORD	E SERIES VAN	V6, 4.2 L	1999	-	2002
DODGE	RAM SERIES PICK	V6, 3.7 L	2002	-	2003
CHEVROLET	C-20	V8, 5.7 L	1991	-	1990
CHEVROLET	C-2500	V8, 5.7 L	1996	-	1995
DODGE	DURANGO	V8, 4.7 L	2000	-	2005
CHEVROLET	MONTE CARLO	V6, 3.4 L	2005	-	2005
HUMMER	H2	V8, 6.0 L	2005	-	2007
CHEVROLET	C-30	V8, 5.7 L	1993	-	1990
CHEVROLET	C-35	V8, 5.7 L	1993	-	1993
HUMMER	H2	V8, 6.0 L	2006	-	2006
CHEVROLET	C & K SERIES PICK	V8, 8.1 L	2001	-	2002
FORD	E SERIES VAN	V8, 5.4 L	2006	-	2007
CHEVROLET	MONTE CARLO	V6, 3.4 L	2004	-	2004
CHEVROLET	C & K SERIES PICK	V8, 7.4 L	2000	-	1999
CADILLAC	ESCALADE	V8, 6.2 L	2007	-	2007
FORD	E SERIES VAN	V8, 4.6 L	2002	-	2003
CADILLAC	ESCALADE	V8, 6.0 L	2002	-	2005
CADILLAC	ESCALADE	V8, 5.3 L	2002	-	2004
JAGUAR	S-TYPE	V8, 4.0 L	2000	-	2001
FORD	E SERIES VAN	V8, 4.6 L	2004	-	2006
GMC	SONOMA	V6, 4.3 L	2004	-	2000
CHEVROLET	BLAZER	V6, 4.3 L	2003	-	1994
HONDA	ACCORD	V6, 3.0 L	2000	-	2000
CHEVROLET	C-3500	V8, 5.7 L	1996	-	1995
CADILLAC	ESCALADE	V8, 5.7 L	1999	-	2000
CHEVROLET	EXPRESS	V8, 8.1 L	2001	-	2002
FORD	E SERIES VAN	V8, 5.4 L	2008	-	2010
CHEVROLET	EXPRESS	V8, 6.0 L	2003	-	2007
CHEVROLET	CAMARO Z28	V8, 5.7 L	1996	-	1997
CHEVROLET	BLAZER	V6, 4.3 L	2004	-	2004
CHEVROLET	AVALANCHE	V8, 5.3 L	2003	-	2003
HONDA	ODYSSEY	V6, 3.5 L	1999	-	2001
CHEVROLET	IMPALA	V6, 3.4 L	2005	-	2005

CHEVROLET	BLAZER	V6, 4.3 L	2005	-	2005
CHEVROLET	AVALANCHE	V8, 8.1 L	2002	-	2002
CHEVROLET	C & K SERIES PICK	V6, 4.3 L	1995	-	1998
CHEVROLET	EXPRESS	V8, 7.4 L	1996	-	2000
DODGE	DURANGO	V6, 3.7 L	2004	-	2005
CHEVROLET	AVALANCHE	V8, 5.3 L	2002	-	2007
GMC	YUKON	V8, 6.2 L	2007	-	2008
CHEVROLET	CENTURY	V6, 3.1 L	1998	-	2000
CHEVROLET	AVALANCHE	V8, 5.3 L	2006	-	2006
CHEVROLET	C & K SERIES PICK	V8, 5.0 L	1997	-	1999
CHEVROLET	EXPRESS	V8, 5.7 L	1996	-	2002
JAGUAR	S-TYPE	V8, 4.0 L	2002	-	2002
CHEVROLET	EXPRESS CARGO	V6, 4.3 L	2004	-	2004
CHEVROLET	EXPRESS CARGO	V6, 4.3 L	2005	-	2006
CHEVROLET	CAPRICE	V8, 4.3 L	1996	-	1996
FORD	THUNDERBIRD	V6, 3.8 L	1994	-	1994
CHEVROLET	IMPALA	V6, 3.4 L	2004	-	2004
CHEVROLET	IMPALA	V6, 3.4 L	2003	-	2003
GMC	YUKON	V8, 5.3 L	2007	-	2008
CHEVROLET	BLAZER	V6, 4.3 L	2000	-	1995
CHEVROLET	EXPRESS	V8, 6.0 L	2004	-	2004
CHEVROLET	IMPALA	V6, 3.4 L	2000	-	2002
PONTIAC	FIREBIRD TRANS /	V8, 5.7 L	1997	-	1997
PONTIAC	GRAND PRIX	V6, 3.1 L	1998	-	2002
MERCURY	MYSTIQUE	V6, 2.5 L	1995	-	2000
MERCURY	MOUNTAINEER	V8, 4.6 L	2003	-	2005
PONTIAC	GRAND PRIX	V6, 3.8 L	2003	-	2005
PONTIAC	TRANS SPORT	V6, 3.4 L	1998	-	1998
MERCURY	MOUNTAINEER	V8, 5.0 L	2001	-	1999
MERCURY	MOUNTAINEER	V6, 4.0 L	2005	-	2004
LINCOLN	NAVIGATOR	V8, 5.4 L	2003	-	2004
MERCURY	SABLE / TAURUS	V6, 3.0 L	1997	-	2001
MERCURY	SABLE / TAURUS	V6, 3.0 L	2002	-	2002
TOYOTA	4 RUNNER	V8, 4.7 L	2003	-	2004
MERCURY	MYSTIQUE	4 CIL. 2.0 L	1995	-	1997
MERCURY	SABLE / TAURUS	V6, 3.0 L	2003	-	2004
LINCOLN	AVIATOR	V8, 4.6 L	2003	-	2005

LINCOLN	NAVIGATOR	V8, 5.4 L	2008	-	2009
LINCOLN	MARK LT	V8, 5.4 L	2007	-	2008

**38002**

Acero D.E. 100mm D.B. 17mm A - 30.5mm Lisa



FORD	EXPLORER	V8, 5.0 L	1998	-	2001
CHEVROLET	CELEBRITY	4 CIL. 2.5 L	1989	-	1989
FORD	AEROSTAR	V6, 4.0 L	1993	-	1995
FORD	AEROSTAR	V6, 3.0 L	1994	-	1997
MERCURY	MOUNTAINEER	V8, 5.0 L	1997	-	2001

**38003**

Acero D.E. 94.5mm D.B. 12mm A - 16.5mm V-Ranurada



DODGE	SHADOW	4 CIL. 2.2 L	1994	-	1994
DODGE	SHADOW	4 CIL. 2.5 L	1993	-	1994
DODGE	CARAVAN	V6, 3.0 L	1995	-	1995
CHRYSLER	LEBARON	4 CIL. 2.5 L	1993	-	1994
DODGE	SPIRIT	V6, 3.0 L	1994	-	1994
DODGE	CARAVAN	4 CIL. 2.5 L	1995	-	1995
CHRYSLER	CONCORDE	V6, 3.5 L	1993	-	1994
CHRYSLER	CONCORDE	V6, 3.3 L	1993	-	1996
CHRYSLER	LEBARON	V6, 3.0 L	1993	-	1995
DODGE	SPIRIT	4 CIL. 2.5 L	1993	-	1994
DODGE	SHADOW	4 CIL. 2.5 L	1995	-	1995
DODGE	INTREPID	V6, 3.3 L	1994	-	1997

**38004**

Acero D.E. 118mm D.B. 12mm A - 16.5mm V-Ranurada



DODGE	INTREPID	V6, 3.5 L	1997	-	1997
-------	----------	-----------	------	---	------

**38005**

Acero D.E. 82mm D.B. 17mm A - 30.5mm Lisa



FORD	WINDSTAR	V6, 3.0 L	1998	-	1998
FORD	WINDSTAR	V6, 3.8 L	1996	-	1997
ACURA	SLX	V6, 3.5 L	1999	-	1999
NISSAN	XTERRA	V6, 3.3 L	2000	-	2001
PONTIAC	TRANSPORT	V6, 3.8 L	1995	-	1995
OLDSMOBILE	SILHOUETTE	V6, 3.8 L	1995	-	1995
NISSAN	FRONTIER	V6, 3.3 L	1999	-	2001

**38006**

Acero D.E. 76mm D.B. 17mm A - 30.5mm Lisa



FORD	THUNDERBIRD	V8, 4.6 L	1997	-	1997
CHEVROLET	UPLANDER	V6, 3.9 L	2008	-	2009
FORD	RANGER	4 CIL. 2.3 L	1996	-	1995
FORD	THUNDERBIRD	V8, 4.6 L	1995	-	1994
FORD	EXPEDITION	V8, 5.4 L	2005	-	2010
FORD	E SERIES VAN	V8, 5.4 L	2008	-	2010
CHEVROLET	UPLANDER	V6, 3.5 L	2006	-	2007
FORD	TOPAZ	4 CIL. 2.3 L	1994	-	1994



CHEVROLET	TRAILBLAZER	6 CIL. 4.2 L	2002	-	2007
FORD	RANGER	4 CIL. 2.5 L	1999	-	1998
CHEVROLET	MONTE CARLO	V6, 3.8 L	2005	-	2005
FORD	RANGER	4 CIL. 2.3 L	2002	-	2004
CHEVROLET	UPLANDER	V6, 3.5 L	2005	-	2005
FORD	F-350 SUPER DUTY	V8, 5.8 L	1997	-	1996
FORD	EXPLORER	V8, 4.6 L	2005	-	2007
CHEVROLET	MALIBU	V6, 3.5 L	2005	-	2005
JEEP	WRANGLER	4 CIL. 2.4 L	2003	-	2006
LINCOLN	CONTINENTAL	V8, 4.6 L	1997	-	2002
CHEVROLET	IMPALA	V6, 3.8 L	2002	-	2004
CHEVROLET	IMPALA	V6, 3.8 L	2005	-	2005
FORD	EXPLORER	V8, 4.6 L	2007	-	2010
CHEVROLET	CAMARO Z28	V8, 5.7 L	2002	-	2002
FORD	F SERIES PICKUP	V8, 5.8 L	1995	-	1997
CHEVROLET	CAMARO Z28	V8, 5.7 L	1998	-	2001
FORD	F-250	V8, 5.0 L	1993	-	1996
FORD	FUSION	V6, 3.0 L	2009	-	2009
FORD	ESCORT	4 CIL. 2.0 L	1998	-	2000
FORD	EXPLORER	V8, 4.6 L	2003	-	2004
FORD	F SERIES PICKUP	V8, 5.0 L	1995	-	1996
CHEVROLET	CUTLASS	V6, 3.1 L	1998	-	1998
CHEVROLET	CUTLASS	V6, 3.1 L	1997	-	1997
FORD	AEROSTAR	V6, 3.0 L	1995	-	1997
FORD	EXPLORER	V8, 5.0 L	1998	-	2001
CHEVROLET	CORVETTE	V8, 5.7 L	1997	-	2001
FORD	EXPLORER SPORT	V8, 4.6 L	2007	-	2010
CHEVROLET	CORVETTE	V8, 5.7 L	2002	-	2004
FORD	FUSION	V6, 3.0 L	2007	-	2008
FORD	F-450 SUPER DUTY	V10, 6.8 L	2008	-	2010
CHEVROLET	UPLANDER	V6, 3.9 L	2006	-	2006
CHEVROLET	UPLANDER	V6, 3.9 L	2007	-	2007
FORD	EXPEDITION	V8, 5.4 L	2003	-	2003
FORD	F-550 SUPER DUTY	V10, 6.8 L	2008	-	2010
CHEVROLET	VENTURE	V6, 3.4 L	2005	-	2005
FORD	ESCORT	4 CIL. 2.0 L	2002	-	2002
CHEVROLET	VENTURE	V6, 3.4 L	1999	-	2001

CHEVROLET	MALIBU	V6, 3.5 L	2004	-	2004
CHEVROLET	VENTURE	V6, 3.4 L	2002	-	2004
CHEVROLET	IMPALA	V6, 3.8 L	2000	-	2003
CHEVROLET	MALIBU	V6, 3.5 L	2006	-	2007
CHEVROLET	MONTE CARLO	V6, 3.8 L	2004	-	2004
FORD	ZX2	4 CIL. 2.0 L	2003	-	2003
CHEVROLET	MALIBU	V6, 3.1 L	2002	-	2003
FORD	E SERIES VAN	V8, 4.6 L	2008	-	2010
CHEVROLET	MALIBU	V6, 3.1 L	1997	-	2001
FORD	MUSTANG	V6, 3.8 L	1999	-	1998
CADILLAC	SRX	V8, 4.6 L	2004	-	2004
FORD	F-350 SUPER DUTY	V8, 5.4 L	2010	-	2010
FORD	F-350 SUPER DUTY	V8, 5.0 L	1993	-	1996
CHEVROLET	LUMINA	V6, 3.8 L	1998	-	1998
FORD	E SERIES VAN	V8, 4.6 L	2004	-	2006
FORD	WINDSTAR	V6, 3.8 L	1995	-	1995
CADILLAC	SEVILLE	V8, 4.6 L	1994	-	2001
FORD	ESCAPE	V6, 3.0 L	2008	-	2009
CHEVROLET	C & K SERIES PICKUP	V8, 8.1 L	2001	-	2002
FORD	MUSTANG	V8, 5.0 L	1994	-	1995
CHEVROLET	C-20	V8, 5.7 L	1990	-	1991
CHEVROLET	C-2500	V8, 5.7 L	1993	-	1995
FORD	CROWN VICTORIA	V8, 4.6 L	2003	-	2004
CHEVROLET	C-30	V8, 5.7 L	1993	-	1990
FORD	CONTOUR	4 CIL. 2.0 L	1998	-	1998
CHEVROLET	C-35	V8, 5.7 L	1993	-	1993
FORD	WINDSTAR	V6, 3.0 L	1998	-	1998
CHEVROLET	C-3500	V8, 5.7 L	1994	-	1995
CADILLAC	DEVILLE	V8, 4.6 L	1998	-	2005
CADILLAC	ELDORADO	V8, 4.6 L	1998	-	2001
CHEVROLET	S-10	V6, 4.3 L	1995	-	1995
CADILLAC	SEVILLE	V8, 4.6 L	2002	-	2004
FORD	MUSTANG	V8, 4.6 L	2000	-	2002
GMC	ENVOY	6 CIL. 4.2 L	2007	-	2002
FORD	RANGER	V6, 3.0 L	2002	-	2002
CHEVROLET	SILVERADO	V8, 6.6 L	2001	-	2001
CHEVROLET	BLAZER	V6, 4.3 L	1993	-	1994



FORD	THUNDERBIRD	V6, 3.8 L	1994	-	1994
CADILLAC	ELDORADO	V8, 4.6 L	1994	-	1999
FORD	ESCAPE	V6, 3.0 L	2001	-	2003
FORD	CONTOUR	V6, 2.5 L	1996	-	1995
FORD	ESCAPE	V6, 3.0 L	2004	-	2004
CADILLAC	ELDORADO	V8, 4.6 L	2002	-	2002
FORD	E SERIES VAN	V8, 5.4 L	2004	-	2005
CADILLAC	DTS	V8, 4.6 L	2006	-	2007
FORD	CROWN VICTORIA	V8, 4.6 L	1996	-	1996
CHEVROLET	BLAZER	V6, 4.3 L	1995	-	1995
FORD	RANGER	V6, 3.0 L	1996	-	2001
FORD	ECOSPORT	4 CIL. 2.0 L	2006	-	2007
FORD	ECOSPORT	4 CIL. 2.0 L	2008	-	2010
CHEVROLET	TRAILBLAZER	6 CIL. 4.2 L	2006	-	2006
FORD	EXPEDITION	V8, 4.6 L	2003	-	2003
CHEVROLET	TRAILBLAZER	6 CIL. 4.2 L	2004	-	2004
CHEVROLET	TRAILBLAZER	6 CIL. 4.2 L	2005	-	2005
CHEVROLET	C & K SERIES PICK	V6, 4.3 L	1995	-	1995
FORD	MUSTANG	V8, 4.6 L	2008	-	2010
LINCOLN	CONTINENTAL	V8, 4.6 L	1995	-	1996
CHEVROLET	S-10	V6, 4.3 L	1994	-	1994
FORD	ECOSPORT	4 CIL. 2.0 L	2004	-	2005
CHEVROLET	EXPRESS	V8, 8.1 L	2001	-	2002
CADILLAC	DEVILLE	V8, 4.6 L	2002	-	2004
GMC	SAVANA	V8, 6.5 L	2002	-	2000
GMC	SAVANA	V8, 8.1 L	2002	-	2001
CHEVROLET	C & K SERIES PICK	V8, 5.7 L	1995	-	1994
FORD	E SERIES VAN	V8, 5.4 L	2006	-	2007
CHEVROLET	SUBURBAN	V8, 5.7 L	1993	-	1995
CHEVROLET	EQUINOX	V6, 3.4 L	2005	-	2007
CHEVROLET	C & K SERIES PICK	V8, 6.5 L	1999	-	2002
CHEVROLET	EXPRESS	V8, 6.5 L	1999	-	2002
PONTIAC	BONNEVILLE	V6, 3.8 L	2003	-	2005
PONTIAC	GRAND AM	V6, 3.4 L	2005	-	2005
PONTIAC	G6	V6, 3.5 L	2007	-	2008
PONTIAC	FIREBIRD TRANS /	V8, 5.7 L	1998	-	2002
SATURN	RELAY	V6, 3.9 L	2006	-	2007

PONTIAC	G6	V6, 3.9 L	2006	-	2006
OLDSMOBILE	EIGHTY EIGHT	V6, 3.8 L	1999	-	1999
PONTIAC	BONNEVILLE	V6, 3.8 L	1994	-	1998
SATURN	AURA	V6, 3.5 L	2007	-	2007
PONTIAC	GRAND AM	V6, 3.4 L	2002	-	2004
PONTIAC	GRAND PRIX	V6, 3.8 L	2004	-	2003
PONTIAC	GRAND PRIX	V6, 3.8 L	1997	-	2001
LINCOLN	TOWN CAR	V8, 4.6 L	1993	-	2000
PONTIAC	AZTEK	V6, 3.4 L	2005	-	2005
LINCOLN	TOWN CAR	V8, 4.6 L	2003	-	2006
PONTIAC	AZTEK	V6, 3.4 L	2001	-	2001
LINCOLN	NAVIGATOR	V8, 5.4 L	2003	-	2003
PONTIAC	AZTEK	V6, 3.4 L	2002	-	2004
LINCOLN	MARK VIII	V8, 4.6 L	1994	-	1996
PONTIAC	MONTANA	V6, 3.9 L	2006	-	2008
PONTIAC	TRANS SPORT	V6, 3.4 L	1999	-	1999
PONTIAC	GRAND AM	V6, 3.4 L	1999	-	2001
MERCURY	MYSTIQUE	V6, 2.5 L	1995	-	2000
MAZDA	MAZDA 3	4 CIL. 2.3 L	2010	-	2010
MAZDA	MAZDA 6	4 CIL. 2.3 L	2008	-	2008
LINCOLN	MARK LT	V8, 5.4 L	2007	-	2008
MERCURY	GRAND MARQUIS	V8, 4.6 L	2005	-	2005
MERCURY	GRAND MARQUIS	V8, 4.6 L	1993	-	1999
MERCURY	MILAN	V6, 3.0 L	2009	-	2009
MERCURY	MILAN	V6, 3.0 L	2006	-	2007
MERCURY	MYSTIQUE	4 CIL. 2.0 L	1998	-	1998
MERCURY	MOUNTAINEER	V8, 5.0 L	2001	-	1999
MERCURY	SABLE / TAURUS	V6, 3.0 L	2002	-	2002
MERCURY	SABLE / TAURUS	V6, 3.0 L	2003	-	2005
MERCURY	SABLE / TAURUS	V6, 3.0 L	1996	-	2001
MERCURY	SABLE / TAURUS	V6, 3.8 L	1993	-	1993
MERCURY	MOUNTAINEER	V8, 4.6 L	2004	-	2003
MERCURY	SABLE / TAURUS	V6, 3.8 L	1994	-	1994
LINCOLN	AVIATOR	V8, 4.6 L	2003	-	2005
LINCOLN	NAVIGATOR	V8, 5.4 L	2008	-	2009
MERCURY	MARINER	V6, 3.0 L	2008	-	2009

**38007**

Termoplástico D.E. 90mm D.B. 17mm A - 25.5mm Lisa

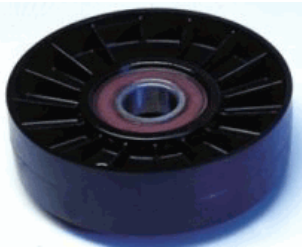

**38008**

Termoplástico D.E. 70mm D.B. 17mm A - 34.5mm V-Ranurada

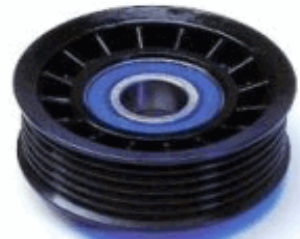

CHEVROLET	CAVALIER	V6, 3.1 L	1993	-	1994
CHEVROLET	CENTURY	V6, 3.1 L	1994	-	1997
FORD	F SERIES PICKUP	V6, 4.2 L	2002	-	2002
FORD	E SERIES VAN	V6, 4.2 L	1999	-	1998
FORD	F SERIES PICKUP	V6, 4.2 L	1998	-	2001
FORD	F-350 SUPER DUTY	V8, 5.0 L	1993	-	1996
CHEVROLET	IMPALA	V6, 3.8 L	2004	-	2004
FORD	F-150	V6, 4.2 L	1998	-	2007
CHEVROLET	CUTLASS	V6, 3.1 L	1993	-	1996
FORD	F-250	V8, 5.0 L	1993	-	1996
CHEVROLET	LUMINA	V6, 3.1 L	1996	-	1997
FORD	F SERIES PICKUP	V8, 5.8 L	1995	-	1997
FORD	F SERIES PICKUP	V8, 5.0 L	1995	-	1996
CHEVROLET	IMPALA	V6, 3.8 L	2005	-	2005
CADILLAC	DEVILLE	V8, 4.9 L	1994	-	1994
FORD	THUNDERBIRD	V6, 3.8 L	1994	-	1994
FORD	SUPER DUTY VAN	V6, 4.2 L	2001	-	2001
FORD	F-350 SUPER DUTY	V8, 5.8 L	1993	-	1997
CHEVROLET	VENTURE	V6, 3.4 L	1997	-	1997
PONTIAC	GRAND PRIX	V6, 3.8 L	1999	-	1998
PONTIAC	TRANS SPORT	V6, 3.1 L	1995	-	1995
OLDSMOBILE	EIGHTY EIGHT	V6, 3.8 L	1999	-	1999
MERCURY	COUGAR XR7	V6, 3.8 L	1993	-	1994
OLDSMOBILE	SILHOUETTE	V6, 3.4 L	1996	-	1996
PONTIAC	TRANS SPORT	V6, 3.4 L	1996	-	1997
PONTIAC	GRAND AM	V6, 3.1 L	1997	-	1997
PONTIAC	BONNEVILLE	V6, 3.8 L	2002	-	2001
PONTIAC	GRAND PRIX	V6, 3.1 L	1997	-	1997
PONTIAC	BONNEVILLE	V6, 3.8 L	2003	-	2003

CADILLAC	ESCALADE	V8, 5.7 L	1999	-	2000
ACURA	SLX	V6, 3.5 L	1999	-	1999
CHEVROLET	C & K SERIES PICKUP	V8, 5.0 L	1997	-	1999
GMC	SAVANA	V8, 8.1 L	2002	-	2001
BMW	Z4	6 CIL. 2.5 L	2003	-	2005
CHEVROLET	C & K SERIES PICKUP	V8, 5.7 L	1996	-	2000
CHEVROLET	EXPRESS	V8, 7.4 L	1996	-	2000
FORD	ESCAPE	4 CIL. 2.0 L	2001	-	2002
CHEVROLET	CAMARO Z28	V8, 5.7 L	1998	-	2001
CHEVROLET	EXPRESS	V8, 8.1 L	2001	-	2002
CHEVROLET	SUBURBAN	V8, 7.4 L	1996	-	1999
FORD	FOCUS	4 CIL. 2.0 L	2000	-	2003
CHEVROLET	C & K SERIES PICKUP	V8, 7.4 L	1999	-	2000
CHEVROLET	SUBURBAN	V8, 5.7 L	1996	-	1999
BMW	Z4	6 CIL. 3.0 L	2003	-	2005
FORD	FUSION	V6, 3.0 L	2009	-	2009
CHEVROLET	EXPRESS	V6, 4.3 L	2003	-	2003
GMC	SAVANA	V8, 7.4 L	2000	-	2000
FORD	EXPLORER SPORT	V6, 4.0 L	2007	-	2009
GMC	SAVANA	V8, 6.6 L	2007	-	2006
FORD	EXPLORER SPORT	V6, 4.0 L	2001	-	2001
CHEVROLET	EXPRESS CARGO	V6, 4.3 L	2005	-	2006
GMC	SONOMA	V6, 4.3 L	2004	-	2000
CHEVROLET	EXPRESS CARGO	V6, 4.3 L	2008	-	2010
CHEVROLET	BLAZER	V6, 4.3 L	2004	-	2004
CHEVROLET	BLAZER	V6, 4.3 L	1996	-	2003
CHEVROLET	EXPRESS CARGO	V6, 4.3 L	2007	-	2007
CHEVROLET	CORVETTE	V8, 5.7 L	2002	-	2004
HUMMER	H1	V8, 6.6 L	2006	-	2006
CHEVROLET	EXPRESS CARGO	V6, 4.3 L	2004	-	2004

CHEVROLET	CORVETTE	V8, 5.7 L	1997	-	2001
FORD	AEROSTAR	V6, 4.0 L	1996	-	1997
FORD	RANGER	V6, 4.0 L	1999	-	2001
FORD	EXPLORER	V8, 5.0 L	1998	-	2001
CHEVROLET	C & K SERIES PICK	V6, 4.3 L	1996	-	1998
CHEVROLET	CAMARO Z28	V8, 5.7 L	2002	-	2002
CHEVROLET	CORVETTE	V8, 6.0 L	2005	-	2007
CHEVROLET	BLAZER	V6, 4.3 L	2005	-	2005
CHEVROLET	EXPRESS	V8, 5.0 L	1996	-	2002
GMC	SAVANA	V6, 4.3 L	2007	-	2000
HUMMER	H1	V8, 6.6 L	2007	-	2007
FORD	WINDSTAR	V6, 3.8 L	2002	-	2003
CHEVROLET	SILVERADO	V6, 4.3 L	1999	-	2001
GMC	SAFARI	V6, 4.3 L	2005	-	2000
FORD	WINDSTAR	V6, 3.8 L	1998	-	2001
CHEVROLET	SILVERADO PICKU	V6, 4.3 L	2004	-	2004
FORD	EXPLORER	V6, 4.0 L	1995	-	2001
FORD	CONTOUR	4 CIL. 2.0 L	1998	-	2000
CHEVROLET	EXPRESS	V6, 4.3 L	1996	-	2002
CHEVROLET	SILVERADO	V8, 6.6 L	2001	-	2002
CHEVROLET	SILVERADO	V8, 6.6 L	2003	-	2007
FORD	ESCAPE	V6, 3.0 L	2005	-	2005
CHEVROLET	C-3500	V8, 5.7 L	1996	-	2000
FORD	EXPLORER	V6, 4.0 L	2007	-	2009
FORD	EXPLORER	V6, 4.0 L	2002	-	2003
GMC	JIMMY	V6, 4.3 L	2005	-	2000
CHEVROLET	SILVERADO PICKU	V6, 4.3 L	2003	-	2007
FORD	FUSION	V6, 3.0 L	2007	-	2008
FORD	FOCUS	4 CIL. 2.0 L	2002	-	2002
GMC	SAVANA	V8, 5.7 L	2002	-	2000
CHEVROLET	S-10	V6, 4.3 L	1996	-	2001
CHEVROLET	C & K SERIES PICK	V8, 8.1 L	2001	-	2002
CHEVROLET	C-2500	V8, 5.7 L	1996	-	2000
CHEVROLET	SILVERADO	V6, 4.3 L	2001	-	2001
CHEVROLET	SILVERADO	V6, 4.3 L	2008	-	2010
GMC	SAVANA	V8, 5.0 L	2002	-	2000
CHEVROLET	EXPRESS	V8, 5.7 L	1996	-	2002

MAZDA	MAZDA 6	4 CIL. 2.3 L	2006	-	2007
MAZDA	MX-5 MIATA	4 CIL. 2.0 L	2006	-	2007
MERCURY	MILAN	V6, 3.0 L	2009	-	2009
MERCURY	MOUNTAINEER	V6, 4.0 L	1998	-	2003
MERCURY	MYSTIQUE	4 CIL. 2.0 L	1998	-	2000
MERCURY	MILAN	V6, 3.0 L	2006	-	2007
PONTIAC	FIREBIRD TRANS /	V8, 5.7 L	1998	-	2002

**38009**

Termoplástico D.E. 76mm D.B. 17mm A - 25mm V-Ranurada



FORD	MUSTANG	V6, 3.8 L	1999	-	1998
DODGE	RAM SERIES PICK	V6, 3.7 L	2002	-	2003
DODGE	RAM 1500	V6, 3.7 L	2006	-	2007
DODGE	NITRO	V6, 4.0 L	2007	-	2008
FORD	E SERIES VAN	V6, 4.2 L	1997	-	2003
DODGE	RAM SERIES PICK	V8, 4.7L	2002	-	2003
DODGE	INTREPID	V6, 2.7 L	2002	-	2003
DODGE	RAM 2500	V8, 4.7L	2002	-	2003
DODGE	DAKOTA	V6, 3.7 L	2007	-	2008
DODGE	RAM 2500	V8, 4.7 L	2004	-	2007
DODGE	NITRO	V6, 4.0 L	2009	-	2010
DODGE	DURANGO	V6, 3.7 L	2004	-	2005
DODGE	NITRO	V6, 3.7 L	2007	-	2008
DODGE	DURANGO	V8, 4.7 L	2000	-	2005
FORD	THUNDERBIRD	V6, 3.8 L	1994	-	1994
DODGE	DURANGO	V8, 4.7 L	2006	-	2006
CHEVROLET	SILVERADO	V8, 5.3 L	2008	-	2010
CHEVROLET	EXPRESS	V8, 6.0 L	2003	-	2007
GMC	YUKON	V8, 6.2 L	2007	-	2008
GMC	YUKON	V8, 6.2 L	2009	-	2010
GMC	YUKON	V8, 5.3 L	2007	-	2008
GMC	SIERRA	V8, 6.2 L	2007	-	2008
GMC	SIERRA	V8, 6.2 L	2009	-	2010



GMC	SIERRA	V8, 5.3 L	2009	-	2010
CADILLAC	ESCALADE	V8, 5.3 L	2002	-	2004
GMC	SAVANA	V8, 6.0 L	2007	-	2003
CHEVROLET	CAVALIER	V6, 3.1 L	1993	-	1993
GMC	SAVANA	V8, 4.8 L	2007	-	2003
HUMMER	H2	V8, 6.2 L	2008	-	2010
CHEVROLET	SUBURBAN	V8, 5.3 L	2003	-	2004
CHEVROLET	SILVERADO	V8, 4.8 L	2001	-	2002
CHEVROLET	EXPRESS	V8, 5.3 L	2008	-	2010
CHEVROLET	SILVERADO	V8, 5.3 L	2003	-	2007
CHEVROLET	SILVERADO	V8, 5.3 L	2000	-	2002
CADILLAC	CTS	V6, 3.2 L	2003	-	2003
CHEVROLET	SILVERADO	V8, 6.0 L	2003	-	2007
CHEVROLET	SILVERADO	V8, 6.0 L	2000	-	2002
CHEVROLET	SILVERADO	V8, 8.1 L	2003	-	2007
FORD	WINDSTAR	V6, 3.8 L	1995	-	1998
CHEVROLET	SILVERADO	V8, 8.1 L	2001	-	2002
CHEVROLET	SILVERADO PICKU	V8, 4.8 L	2007	-	2004
CHEVROLET	SILVERADO PICKU	V8, 5.3 L	2000	-	2007
CHEVROLET	SILVERADO PICKU	V8, 6.0 L	2005	-	2006
CHEVROLET	SILVERADO PICKU	V8, 8.1 L	2003	-	2004
CHEVROLET	SUBURBAN	V8, 5.3 L	2008	-	2010
CHEVROLET	SILVERADO	V8, 4.8 L	2003	-	2007
HUMMER	H2	V8, 6.0 L	2006	-	2006
CHEVROLET	CORVETTE	V8, 5.7 L	1993	-	1993
CHEVROLET	CORVETTE	V8, 6.0 L	2005	-	2005
CHEVROLET	CORVETTE	V8, 6.0 L	2006	-	2007
CHEVROLET	CUTLASS	V6, 3.1 L	1997	-	1997
CHEVROLET	CUTLASS	V6, 3.1 L	1998	-	1998
CHEVROLET	IMPALA	V6, 3.8 L	2005	-	2005
CHEVROLET	IMPALA	V6, 3.8 L	2004	-	2004
CHEVROLET	MALIBU	V6, 3.1 L	2002	-	2003
CHEVROLET	MALIBU	V6, 3.1 L	1997	-	2001
CHEVROLET	MALIBU	V6, 3.5 L	2005	-	2005
CHEVROLET	MALIBU	V6, 3.5 L	2004	-	2004
CHEVROLET	MALIBU	V6, 3.5 L	2006	-	2007
CHEVROLET	MALIBU	V6, 3.5 L	2007	-	2007

CHEVROLET	EXPRESS	V8, 6.0 L	2008	-	2010
CHEVROLET	AVALANCHE	V8, 8.1 L	2002	-	2002
CHEVROLET	SILVERADO	V8, 4.8 L	2008	-	2010
CHEVROLET	EQUINOX	V6, 3.4 L	2007	-	2007
CHEVROLET	EQUINOX	V6, 3.4 L	2005	-	2006
CADILLAC	ESCALADE	V8, 6.0 L	2006	-	2006
CADILLAC	ESCALADE	V8, 6.0 L	2002	-	2005
GMC	ENVOY	V8, 5.3 L	2007	-	2003
CADILLAC	ESCALADE	V8, 6.2 L	2007	-	2007
HUMMER	H2	V8, 6.0 L	2007	-	2007
CHEVROLET	AVALANCHE	V8, 5.3 L	2002	-	2007
CHEVROLET	AVALANCHE	V8, 5.3 L	2003	-	2003
CHEVROLET	AVALANCHE	V8, 5.3 L	2008	-	2010
CHEVROLET	AVALANCHE	V8, 5.3 L	2006	-	2006
CHEVROLET	AVALANCHE	V8, 5.3 L	2005	-	2005
CHEVROLET	EXPRESS	V8, 5.3 L	2003	-	2007
CADILLAC	ESCALADE	V8, 6.2 L	2008	-	2010
JEEP	GRAND CHEROKE	V6, 3.7 L	2005	-	2005
CHEVROLET	UPLANDER	V6, 3.5 L	2005	-	2005
CHEVROLET	UPLANDER	V6, 3.5 L	2007	-	2007
CHEVROLET	UPLANDER	V6, 3.5 L	2006	-	2006
CHEVROLET	UPLANDER	V6, 3.9 L	2008	-	2009
CHEVROLET	UPLANDER	V6, 3.9 L	2006	-	2007
CHEVROLET	VENTURE	V6, 3.4 L	2005	-	2005
CHEVROLET	VENTURE	V6, 3.4 L	2002	-	2003
CHEVROLET	VENTURE	V6, 3.4 L	2004	-	2004
JEEP	GRAND CHEROKE	V8, 4.7 L	2007	-	2007
CADILLAC	CTS	V6, 3.2 L	2004	-	2004
CHEVROLET	TRAILBLAZER	V8, 6.0 L	2006	-	2006
JEEP	GRAND CHEROKE	V6, 3.7 L	2006	-	2007
CHEVROLET	VENTURE	V6, 3.4 L	1999	-	2001
CADILLAC	CATERA	V6, 3.0 L	1998	-	2001
CHEVROLET	SUBURBAN	V8, 5.3 L	2000	-	2007
GMC	SAVANA	V8, 5.3 L	2007	-	2003
JEEP	GRAND CHEROKE	V8, 4.7 L	1999	-	2006
JEEP	LIBERTY	V6, 3.7 L	2005	-	2005
JEEP	LIBERTY	V6, 3.7 L	2008	-	2009



FORD	F-150	V6, 4.2 L	2003	-	2006
JEEP	LIBERTY	V6, 3.7 L	2002	-	2003
JEEP	LIBERTY	V6, 3.7 L	2006	-	2007
JEEP	LIBERTY	V6, 3.7 L	2004	-	2004
CHRYSLER	VOYAGER	V6, 3.0 L	2000	-	2000
CHEVROLET	TRAILBLAZER	V8, 5.3 L	2005	-	2005
CHEVROLET	TAHOE	V8, 5.3 L	2006	-	2007
FORD	F SERIES PICKUP	V6, 4.2 L	1998	-	2002
CHEVROLET	SUBURBAN	V8, 8.1 L	2001	-	2006
CHEVROLET	SUBURBAN	V8, 8.1 L	2002	-	2002
CHEVROLET	TAHOE	V8, 5.3 L	2008	-	2010
CHEVROLET	SUBURBAN	V8, 7.4 L	1994	-	1995
CHEVROLET	TAHOE	V8, 4.8 L	2006	-	2007
FORD	RANGER	4 CIL. 2.3 L	1996	-	1995
CHEVROLET	TRAILBLAZER	V8, 5.3 L	2003	-	2003
CHEVROLET	SUBURBAN	V8, 6.0 L	2000	-	2007
CHEVROLET	TRAILBLAZER	V8, 5.3 L	2006	-	2006
CHEVROLET	TRAILBLAZER	V8, 5.3 L	2007	-	2007
CHEVROLET	SUBURBAN	V8, 6.0 L	2008	-	2010
SAAB	9 - 5	V6, 3.0 L	2000	-	2000
SAAB	9 - 5	V6, 3.0 L	2002	-	2003
SATURN	RELAY	V6, 3.5 L	2005	-	2006
PONTIAC	TRANS SPORT	V6, 3.4 L	1999	-	1999
SATURN	RELAY	V6, 3.9 L	2006	-	2007
SATURN	AURA	V6, 3.5 L	2007	-	2007
PONTIAC	GRAND PRIX	V6, 3.8 L	2003	-	2005
MERCURY	COUGAR XR7	V6, 3.8 L	1993	-	1994
MERCURY	SABLE / TAURUS	V6, 3.8 L	1993	-	1993
MERCURY	SABLE / TAURUS	V6, 3.8 L	1994	-	1995
OLDSMOBILE	EIGHTY EIGHT	V6, 3.8 L	1999	-	1999
PONTIAC	BONNEVILLE	V6, 3.8 L	2003	-	2003
PONTIAC	BONNEVILLE	V6, 3.8 L	1999	-	1998
PONTIAC	G6	V6, 3.5 L	2006	-	2008
PONTIAC	G6	V6, 3.9 L	2006	-	2006
PONTIAC	GRAND AM	V6, 3.4 L	1999	-	2001
PONTIAC	TRANS SPORT	V6, 3.1 L	1995	-	1995
PONTIAC	GRAND PRIX	V6, 3.8 L	1999	-	1998

PONTIAC	AZTEK	V6, 3.4 L	2005	-	2005
PONTIAC	AZTEK	V6, 3.4 L	2002	-	2004
PONTIAC	AZTEK	V6, 3.4 L	2001	-	2001
PONTIAC	MONTANA	V6, 3.5 L	2006	-	2006
PONTIAC	MONTANA	V6, 3.9 L	2007	-	2008
PONTIAC	MONTANA	V6, 3.9 L	2006	-	2006
PONTIAC	TORRENT	V6, 3.4 L	2006	-	2008
PONTIAC	GRAND AM	V6, 3.4 L	2002	-	2004
PONTIAC	GRAND AM	V6, 3.4 L	2005	-	2005

**38010**

Acero D.E. 90mm D.B. 17mm A - 27mm Lisa



CHEVROLET	TRACKER	4 CIL. 2.0 L	1999	-	2001
CHEVROLET	TRACKER	4 CIL. 2.0 L	2002	-	2003
SUZUKI	AERIO	4 CIL. 2.3 L	2005	-	2005
SUZUKI	AERIO	4 CIL. 2.3 L	2006	-	2006

**38011**

Acero D.E. 82mm D.B. 17mm A - 27mm Lisa



CHEVROLET	CAVALIER	4 CIL. 2.2 L	2005	-	2005
CHEVROLET	CAVALIER	4 CIL. 2.4 L	1996	-	1998
CHEVROLET	MALIBU	4 CIL. 2.2 L	2004	-	2004
CHEVROLET	CAVALIER	4 CIL. 2.2 L	2003	-	2004
CHEVROLET	CAPTIVA	4 CIL. 2.4 L	2008	-	2008
CHEVROLET	MALIBU	4 CIL. 2.4 L	1997	-	1998
CHEVROLET	MALIBU	4 CIL. 2.2 L	2005	-	2006
CHEVROLET	CAVALIER	4 CIL. 2.2 L	1999	-	1998
CHEVROLET	HHR	4 CIL. 2.4 L	2006	-	2007
CHEVROLET	CAVALIER	4 CIL. 2.3 L	1995	-	1995

CHEVROLET	MALIBU	4 CIL. 2.2 L	2007	-	2007
CHEVROLET	CAPTIVA	4 CIL. 2.4 L	2009	-	2010
PONTIAC	G5	4 CIL. 2.2 L	2007	-	2008
PONTIAC	GRAND AM	4 CIL. 2.2 L	2002	-	2003
PONTIAC	G5	4 CIL. 2.4 L	2007	-	2008
PONTIAC	SUNFIRE	4 CIL. 2.4 L	1997	-	1998
PONTIAC	SUNFIRE	4 CIL. 2.3 L	1995	-	1995
PONTIAC	SUNFIRE	4 CIL. 2.2 L	1999	-	1998
PONTIAC	G4	4 CIL. 2.2 L	2006	-	2006
PONTIAC	SUNFIRE	4 CIL. 2.2 L	2003	-	2003
PONTIAC	GRAND AM	4 CIL. 2.4 L	1999	-	1999
PONTIAC	G4	4 CIL. 2.4 L	2006	-	2006
SATURN	ION	4 CIL. 2.2 L	2007	-	2003
SATURN	ION	4 CIL. 2.4 L	2006	-	2007
SATURN	SKY	4 CIL. 2.4 L	2007	-	2007
PONTIAC	SUNFIRE	4 CIL. 2.2 L	2002	-	2004
PONTIAC	SUNFIRE	4 CIL. 2.2 L	2005	-	2005
PONTIAC	SOLSTICE	4 CIL. 2.4 L	2006	-	2008
SAAB	9 - 3	4 CIL. 2.0 L	2003	-	2003

DODGE	RAM 2500	V8, 4.7 L	2004	-	2007
FORD	F SERIES PICKUP	V8, 5.8 L	1995	-	1996
CHEVROLET	AVEO	4 CIL. 1.6 L	2008	-	2008
AUDI	A4	V6, 3.2 L	2006	-	2006
AUDI	A6	V6, 3.2 L	2006	-	2006
AUDI	A6	V6, 3.2 L	2007	-	2007
FORD	F SERIES PICKUP	V8, 5.0 L	1995	-	1996
CHEVROLET	S-10	4 CIL. 2.2 L	2003	-	2003
GMC	SONOMA	4 CIL. 2.2 L	2003	-	2000
DODGE	RAM 1500	V6, 3.7 L	2006	-	2007
CHEVROLET	REGAL	V6, 3.8 L	1996	-	1996
CHEVROLET	AVEO	4 CIL. 1.6 L	2009	-	2009
AUDI	A4	V6, 3.2 L	2007	-	2007
CHEVROLET	CORVETTE	V8, 5.7 L	1994	-	1993
FORD	F-250	V8, 5.0 L	1993	-	1996
CHEVROLET	LUMINA	V6, 3.8 L	1998	-	1998
FORD	F-350 SUPER DUTY	V8, 5.0 L	1993	-	1996
AUDI	A6	V6, 3.2 L	2008	-	2008
CHEVROLET	CAVALIER	4 CIL. 2.2 L	1998	-	2002
CHEVROLET	S-10	4 CIL. 2.2 L	2002	-	2002
AUDI	A6	V6, 3.0 L	2005	-	2006
AUDI	A4	V6, 3.2 L	2008	-	2009
PONTIAC	BONNEVILLE	V6, 3.8 L	1994	-	1995
PONTIAC	SUNFIRE	4 CIL. 2.2 L	1998	-	2002
PONTIAC	G3	4 CIL. 1.6 L	2006	-	2008
PONTIAC	GRAND PRIX	V6, 3.8 L	1997	-	1998
SUZUKI	SWIFT	4 CIL. 1.6 L	2006	-	2007
SUZUKI	SWIFT	4 CIL. 1.6 L	2008	-	2008
OLDSMOBILE	EIGHTY EIGHT	V6, 3.8 L	1998	-	1998

**38012**



FORD	F SERIES PICKUP	6 CIL. 4.9 L	1996	-	1996
------	-----------------	--------------	------	---	------

**38015**

Termoplástico D.E. 76mm D.B. 17mm A - 25mm Lisa

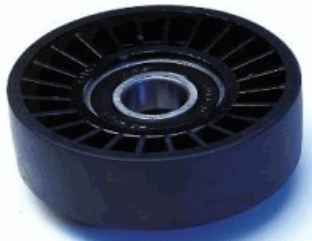

CHEVROLET	S-10	4 CIL. 2.2 L	1998	-	2001
FORD	AEROSTAR	V6, 3.0 L	1993	-	1997
JEEP	LIBERTY	V6, 3.7 L	2008	-	2009

**38016**

Termoplástico D.E. 76mm D.B. 17mm A - 32mm V-Ranurada

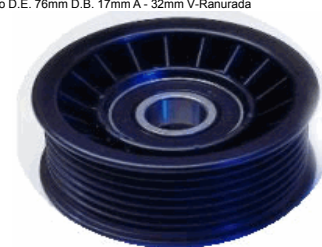

DODGE	RAM 3500	V8, 5.9 L	1994	-	2002
-------	----------	-----------	------	---	------

DODGE	RAM MAXI WAGON	V8, 5.2 L	1996	-	1996
DODGE	RAM SERIES PICK	V8, 5.9 L	2002	-	2002
DODGE	RAM SERIES PICK	V8, 5.2 L	1995	-	2001
DODGE	RAM SERIES PICK	V8, 5.9 L	1994	-	2001
DODGE	RAM WAGON 1500	V8, 5.2 L	1997	-	2001
DODGE	RAM WAGON 2500	V8, 5.2 L	1997	-	2001
DODGE	RAM WAGON 2500	V8, 5.9 L	1994	-	1995
DODGE	RAM SERIES PICK	V6, 3.9 L	1994	-	2001
DODGE	RAM MAXI WAGON	V8, 5.9 L	1996	-	2001
DODGE	RAM MAXI VAN 150	V6, 3.9 L	2002	-	2002
DODGE	RAM WAGON 3500	V8, 5.9 L	2002	-	2002
DODGE	RAM 4000	V8, 5.9 L	1995	-	2002
DODGE	RAM MAXI VAN 350	V8, 5.9 L	1996	-	2001
DODGE	RAM MAXI VAN 350	V8, 5.9 L	2002	-	2002
DODGE	RAM MAXI VAN 250	V8, 5.2 L	1996	-	2001
DODGE	RAM MAXI VAN 250	V8, 5.2 L	2002	-	2002
DODGE	RAM MAXI VAN 150	V6, 3.9 L	1999	-	1999
DODGE	RAM CHARGER	V8, 5.9 L	1993	-	1993
JEEP	GRAND CHEROKE	V8, 5.2 L	1995	-	1998
JEEP	GRAND CHEROKE	V8, 5.9 L	1998	-	1998
DODGE	RAM MAXI WAGON	V8, 5.9 L	2002	-	2002
DODGE	DURANGO	V8, 5.2 L	1998	-	2000
DODGE	D-150	V6, 3.9 L	1993	-	1993
DODGE	D-250	V8, 5.9 L	1993	-	1993
DODGE	B SERIES VAN	V6, 3.9 L	2003	-	2003
DODGE	DURANGO	V6, 3.9 L	1998	-	1999
DODGE	D-350	V8, 5.9 L	1993	-	1993
DODGE	DURANGO	V8, 5.9 L	2001	-	2000
DODGE	RAM 2500	V8, 5.9 L	1994	-	2002
DODGE	RAM 1500	V6, 3.9 L	1994	-	2001
DODGE	RAM 2500	V8, 5.2 L	1997	-	2001

**38017**

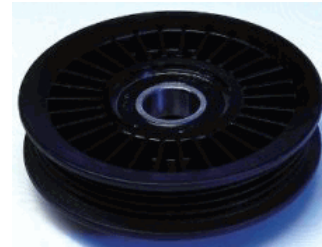

CHEVROLET	ASTRO	V6, 4.3 L	1989	-	1989
-----------	-------	-----------	------	---	------

**38018**

Termoplástico D.E. 70mm D.B. 17mm A - 25mm Lisa

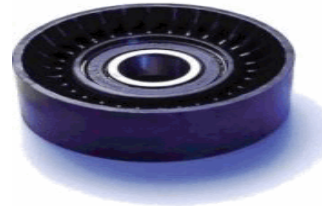

BMW	330XI	6 CIL. 3.0 L	2005	-	2005
BMW	325XI	6 CIL. 2.5 L	2005	-	2005
BMW	X3	6 CIL. 3.0 L	2006	-	2006
BMW	330XI	6 CIL. 3.0 L	2006	-	2006
JEEP	GRAND CHEROKE	V8, 6.1 L	2006	-	2007
BMW	530I	6 CIL. 3.0 L	2002	-	2002
BMW	545I	V8, 4.4 L	2005	-	2005
DODGE	CHARGER	V8, 6.1 L	2007	-	2008
BMW	X5	6 CIL. 3.0 L	2006	-	2006
AUDI	TT	4 CIL. 1.8 L	2003	-	2004
JEEP	GRAND CHEROKE	V8, 5.7 L	2008	-	2009
BMW	X3	6 CIL. 3.0 L	2005	-	2005
BMW	X3	V6, 3.0 L	2007	-	2008
BMW	X5	6 CIL. 3.0 L	2005	-	2005
BMW	X5	V6, 3.0 L	2009	-	2009
DODGE	DURANGO	V8, 5.7 L	2008	-	2009
BMW	X5	V8, 4.4 L	2000	-	2000
JEEP	GRAND CHEROKE	V8, 5.7 L	2005	-	2007
FORD	FOCUS	4 CIL. 2.0 L	2002	-	2002
AUDI	A3	4 CIL. 2.0 L	2008	-	2008
AUDI	A3	4 CIL. 2.0 L	2007	-	2007
AUDI	A3	4 CIL. 2.0 L	2006	-	2006



FORD	FOCUS	4 CIL. 2.0 L	2000	-	2001
JEEP	WRANGLER	V6, 3.8 L	2008	-	2010
JEEP	WRANGLER	6 CIL. 4.0 L	2001	-	2006
JEEP	WRANGLER	6 CIL. 4.0 L	2000	-	2000
AUDI	TT	4 CIL. 1.8 L	2000	-	2001
CHRYSLER	VOYAGER	V6, 3.3 L	2003	-	2007
DODGE	CHARGER	V8, 5.7 L	2007	-	2008
CHRYSLER	TOWN & COUNTRY	V6, 4.0 L	2008	-	2010
CHRYSLER	TOWN & COUNTRY	V6, 3.8 L	2005	-	2007
DODGE	CHARGER	V8, 5.7 L	2009	-	2009
BMW	X5	V8, 4.6 L	2002	-	2002
JEEP	WRANGLER	4 CIL. 2.4 L	2003	-	2006
AUDI	TT	4 CIL. 1.8 L	2002	-	2002
AUDI	TT	4 CIL. 1.8 L	2005	-	2006
CHRYSLER	VOYAGER	V6, 3.3 L	2001	-	2002
CHEVROLET	TRAILBLAZER	6 CIL. 4.2 L	2004	-	2004
JEEP	COMMANDER	V8, 5.7 L	2009	-	2009
FORD	CONTOUR	4 CIL. 2.0 L	1998	-	2000
FORD	ESCAPE	4 CIL. 2.0 L	2001	-	2002
DODGE	CARAVAN	V6, 3.3 L	2007	-	2007
DODGE	CARAVAN	V6, 3.3 L	2002	-	2006
JEEP	GRAND CHEROKE	6 CIL. 4.0 L	1999	-	2002
CHEVROLET	COLORADO	5 CIL. 3.5 L	2004	-	2004
CHEVROLET	COLORADO	5 CIL. 3.5 L	2006	-	2006
CHEVROLET	COLORADO	5 CIL. 3.5 L	2005	-	2005
JEEP	COMMANDER	V8, 5.7 L	2007	-	2008
CHEVROLET	TRAILBLAZER	6 CIL. 4.2 L	2005	-	2005
JEEP	COMMANDER	V8, 5.7 L	2006	-	2006
CHEVROLET	COLORADO	4 CIL. 2.8 L	2005	-	2005
CHEVROLET	TRAILBLAZER	6 CIL. 4.2 L	2006	-	2007
CHEVROLET	TRAILBLAZER	6 CIL. 4.2 L	2002	-	2003
CHRYSLER	300 C	V8, 5.7 L	2007	-	2009
DODGE	JOURNEY	V6, 3.5 L	2010	-	2009
DODGE	NITRO	V6, 4.0 L	2009	-	2010
DODGE	NITRO	V6, 4.0 L	2007	-	2008
DODGE	RAM 2500	V8, 5.7 L	2009	-	2009
JEEP	GRAND CHEROKE	V6, 4.0 L	2003	-	2003

CHEVROLET	COLORADO	4 CIL. 2.8 L	2006	-	2006
VOLKSWAGEN	GOLF	4 CIL. 1.8 L	2005	-	2006
VOLKSWAGEN	JETTA	4 CIL. 1.8 L	2004	-	2004
VOLVO	S60	5 CIL. 2.5 L	2004	-	2006
VOLVO	S70	5 CIL. 2.3 L	2000	-	2000
VOLVO	S70	5 CIL. 2.4 L	2000	-	2000
VOLVO	S80	5 CIL. 2.5 L	2005	-	2006
VOLVO	S80	6 CIL. 2.8 L	2000	-	2001
VOLVO	S80	6 CIL. 2.9 L	2000	-	2005
VOLVO	S60	5 CIL. 2.3 L	2001	-	2001
VOLVO	S40	4 CIL. 1.9 L	2000	-	2004
TOYOTA	MATRIX	4 CIL. 1.8 L	2003	-	2008
VOLKSWAGEN	PASSAT	4 CIL. 2.0 L	2007	-	2008
VOLVO	C70	5 CIL. 2.4 L	2000	-	2004
VOLVO	C70	5 CIL. 2.3 L	2000	-	2004
VOLKSWAGEN	GOLF	4 CIL. 1.8 L	2000	-	2004
TOYOTA	COROLLA	4 CIL. 1.8 L	2002	-	2008
MERCURY	MYSTIQUE	4 CIL. 2.0 L	1999	-	1998
TOYOTA	COROLLA	4 CIL. 1.8 L	2006	-	2006
TOYOTA	COROLLA	4 CIL. 1.8 L	2003	-	2005
VOLKSWAGEN	GOLF	4 CIL. 2.0 L	1999	-	2005
VOLKSWAGEN	PASSAT	4 CIL. 2.0 L	2006	-	2006
VOLKSWAGEN	BEETLE	4 CIL. 2.0 L	1998	-	2005
VOLVO	S60	5 CIL. 2.4 L	2001	-	2006
VOLKSWAGEN	JETTA	4 CIL. 2.0 L	1999	-	2006
VOLKSWAGEN	BEETLE	4 CIL. 2.0 L	2007	-	2008
VOLKSWAGEN	BEETLE	4 CIL. 1.8 L	1999	-	2005
VOLKSWAGEN	BORA	4 CIL. 1.9 L DIESEL	2007	-	2007
VOLKSWAGEN	JETTA	4 CIL. 1.9 L DIESEL	2004	-	2007
VOLKSWAGEN	ROUTAN	V6, 3.8 L	2009	-	2010
VOLKSWAGEN	JETTA	4 CIL. 2.0 L	2007	-	2008
VOLKSWAGEN	JETTA	4 CIL. 2.0 L	2009	-	2010
TOYOTA	CAMRY	4 CIL. 2.5 L	2010	-	2011
VOLKSWAGEN	GOLF	4 CIL. 2.0 L	2006	-	2006
VOLKSWAGEN	JETTA	4 CIL. 1.8 L	2000	-	2005
TOYOTA	MATRIX	4 CIL. 1.8 L	2005	-	2006
VOLKSWAGEN	JETTA	4 CIL. 1.8 L	2006	-	2006

VOLKSWAGEN	BEETLE	4 CIL. 2.0 L	2006	-	2006
------------	--------	--------------	------	---	------

**38019**

Termoplástico D.E. 90mm D.B. 17mm A - 26.3mm V-Ranurada



CHEVROLET	C & K SERIES PICK	V8, 7.4 L	1995	-	1995
JEEP	WRANGLER	6 CIL. 4.0 L	1997	-	1998
JEEP	WRANGLER	4 CIL. 2.5 L	1997	-	1998
CHEVROLET	SUBURBAN	V8, 7.4 L	1993	-	1995
JEEP	CHEROKEE	6 CIL. 4.0 L	1996	-	2001

**38020**

Acero D.E. 90mm D.B. 12mm A - 30.5mm Lisa



CHRYSLER	CIRRUS	V6, 2.5 L	1996	-	2000
CHRYSLER	CIRRUS	4 CIL. 2.4 L	1997	-	2000
CHRYSLER	CIRRUS	4 CIL. 2.0 L	2000	-	2000
CHRYSLER	CONCORDE	V6, 3.2 L	2001	-	2000
CHEVROLET	C & K SERIES PICK	V8, 6.5 L	1999	-	2002
CHRYSLER	300M	V6, 3.5 L	1999	-	2000
DODGE	INTREPID	V6, 3.5 L	1994	-	2000
CHRYSLER	CONCORDE	V6, 3.5 L	1993	-	1994
CHRYSLER	SEBRING	4 CIL. 2.4 L	1996	-	1996
DODGE	STRATUS	4 CIL. 2.0 L	1996	-	2000
DODGE	INTREPID	V6, 3.2 L	1998	-	2000
DODGE	STRATUS	4 CIL. 2.4 L	1995	-	2000
DODGE	STRATUS	V6, 2.5 L	1999	-	2000
CHRYSLER	CONCORDE	V6, 3.5 L	1995	-	1997
CHRYSLER	GRAND VOYAGER	V6, 3.8 L	1994	-	1999
CHRYSLER	SEBRING	4 CIL. 2.4 L	1997	-	1997
CHRYSLER	NEW YORKER	V6, 3.3 L	1993	-	1993

CHEVROLET	EXPRESS	V8, 6.5 L	1999	-	2002
CADILLAC	DEVILLE	V8, 4.9 L	1993	-	1993
CHRYSLER	VOYAGER	V6, 3.3 L	1996	-	2000
JEEP	GRAND CHEROKE	6 CIL. 4.0 L	1996	-	1999
JEEP	WRANGLER	4 CIL. 2.5 L	2002	-	2002
GMC	SAVANA	V8, 6.5 L	2002	-	2000
JEEP	CHEROKEE	6 CIL. 4.0 L	1995	-	2000
JEEP	WRANGLER	4 CIL. 2.5 L	1999	-	2001

**38022**

Acero D.E. 90mm D.B. 17mm A - 37.5mm Lisa



FORD	EXPEDITION	V8, 4.6 L	1997	-	2001
FORD	F-450 SUPER DUTY	V10, 6.8 L	1999	-	2006
FORD	EXCURSION	V10, 6.8 L	2000	-	2003
FORD	SUPER DUTY PICK	V8, 5.4 L	1999	-	2001
FORD	SUPER DUTY VAN	V8, 5.4 L	1999	-	2001
FORD	EXPEDITION	V8, 5.4 L	2002	-	2002
FORD	EXCURSION	V10, 6.8 L	2002	-	2002
FORD	MUSTANG	V6, 3.8 L	1996	-	1998
FORD	EXPEDITION	V8, 5.4 L	1997	-	2001
FORD	EXPLORER	V8, 4.6 L	2002	-	2003
FORD	F-150	V6, 4.9 L	1995	-	1996
FORD	SUPER DUTY VAN	V10, 6.8 L	1999	-	2001
FORD	F-250	V8, 4.6 L	1998	-	2004
FORD	F SERIES PICKUP	V8, 5.4 L	1999	-	2002
FORD	EXPEDITION	V8, 4.6 L	2002	-	2002
FORD	EXCURSION	V10, 6.8 L	2004	-	2005
FORD	SUPER DUTY VAN	V8, 4.6 L	2003	-	2003
FORD	E SERIES VAN	V8, 5.4 L	2002	-	2001
FORD	E SERIES VAN	V8, 4.6 L	1999	-	2001
FORD	SUPER DUTY PICK	V10, 6.8 L	1999	-	2000
FORD	F-350 SUPER DUTY	V8, 5.4 L	1999	-	2006
FORD	F SERIES PICKUP	V8, 4.6 L	1998	-	2001

FORD	SUPER DUTY PICK	V10, 6.8 L	2002	-	2002
FORD	F SERIES PICKUP	V6, 4.9 L	1995	-	1996
FORD	F SERIES PICKUP	V10, 6.8 L	1999	-	2000
FORD	SUPER DUTY PICK	V8, 5.4 L	2002	-	2002
FORD	LOBO	V8, 5.4 L	2002	-	2002
FORD	E SERIES VAN	V10, 6.8 L	1997	-	1998
FORD	E SERIES VAN	V8, 7.3 L	1997	-	1997
FORD	E SERIES VAN	6 CIL. 4.9 L	1995	-	1996
FORD	EXCURSION	V8, 5.4 L	2001	-	2001
LINCOLN	NAVIGATOR	V8, 5.4 L	2002	-	2002
LINCOLN	NAVIGATOR	V8, 5.4 L	1998	-	2001

FORD	F-250	V8, 4.6 L	1998	-	2004
FORD	F SERIES PICKUP	V8, 4.6 L	1998	-	2001
FORD	F SERIES PICKUP	V8, 5.4 L	2002	-	2001
FORD	SUPER DUTY PICK	V10, 6.8 L	1999	-	2000
FORD	E SERIES VAN	V10, 6.8 L	1997	-	1998
FORD	E SERIES VAN	V8, 5.4 L	2002	-	2001
FORD	EXPEDITION	V8, 5.4 L	1997	-	2001
FORD	SUPER DUTY VAN	V8, 7.3 L	1999	-	2001
FORD	F-350 SUPER DUTY	V8, 5.4 L	1999	-	2006
LINCOLN	NAVIGATOR	V8, 5.4 L	2002	-	2002
MERCURY	SABLE / TAURUS	V6, 3.8 L	1995	-	1995
LINCOLN	NAVIGATOR	V8, 5.4 L	1998	-	2001

**38023**

Termoplástico D.E. 76mm D.B. 17mm A - 34mm Lisa



**38024**

Termoplástico D.E. 09mm D.B. 17mm A - 26.3mm V-Ranurada

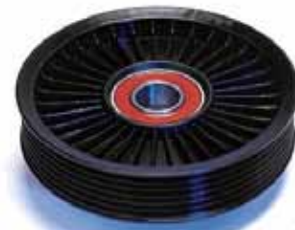

FORD	EXCURSION	V8, 5.4 L	2001	-	2000
FORD	SUPER DUTY PICK	V8, 7.3 L	1999	-	2001
FORD	SUPER DUTY PICK	V8, 5.4 L	2002	-	2002
FORD	EXPEDITION	V8, 4.6 L	2002	-	2002
FORD	SUPER DUTY PICK	V8, 5.4 L	1999	-	2001
FORD	SUPER DUTY PICK	V8, 7.3 L	2002	-	2002
FORD	EXCURSION	V10, 6.8 L	2000	-	2001
FORD	EXPEDITION	V8, 4.6 L	1997	-	2001
FORD	E SERIES VAN	V8, 4.6 L	1999	-	2001
FORD	EXPEDITION	V8, 5.4 L	2002	-	2002
FORD	SUPER DUTY PICK	V10, 6.8 L	2002	-	2002
FORD	SUPER DUTY VAN	V10, 6.8 L	2000	-	1999
FORD	F SERIES PICKUP	V10, 6.8 L	1999	-	2000
FORD	SUPER DUTY VAN	V8, 5.4 L	1999	-	2001
FORD	LOBO	V8, 5.4 L	2002	-	2002
FORD	F-450 SUPER DUTY	V10, 6.8 L	1999	-	2006
FORD	EXCURSION	V10, 6.8 L	2002	-	2003
FORD	WINDSTAR	V6, 3.8 L	1995	-	1995
FORD	THUNDERBIRD	V6, 3.8 L	1994	-	1994

CHEVROLET	C & K SERIES PICKUP	V8, 5.7 L	1993	-	1995
CHEVROLET	S-10	V6, 4.3 L	1994	-	1994
CHEVROLET	BLAZER	V6, 4.3 L	1995	-	1995
CHEVROLET	C-35	V8, 5.7 L	1993	-	1993
CHEVROLET	BLAZER	V6, 4.3 L	1993	-	1994
CHEVROLET	AVEO	4 CIL. 1.6 L	2008	-	2008
CHEVROLET	SUBURBAN	V8, 5.7 L	1993	-	1995
CHEVROLET	C-2500	V8, 5.7 L	1993	-	1995
CHEVROLET	S-10	V6, 4.3 L	1995	-	1995
CHEVROLET	C-30	V8, 5.7 L	1993	-	1990
CHEVROLET	C & K SERIES PICKUP	V6, 4.3 L	1995	-	1995
CHEVROLET	C-20	V8, 5.7 L	1991	-	1990
CHEVROLET	C-3500	V8, 5.7 L	1994	-	1995
CHEVROLET	AVEO	4 CIL. 1.6 L	2009	-	2009
SUZUKI	SWIFT	4 CIL. 1.6 L	2008	-	2008
PONTIAC	G3	4 CIL. 1.6 L	2006	-	2008
SUZUKI	SWIFT	4 CIL. 1.6 L	2006	-	2007

**38025**

Termoplástico D.E. 52mm D.B. 17mm A - 15mm V-Ranurada



CADILLAC	SEVILLE	V8, 4.6 L	1995	-	2001
CADILLAC	SEVILLE	V8, 4.6 L	2002	-	2004
CADILLAC	DTS	V8, 4.6 L	2006	-	2007
CADILLAC	DEVILLE	V8, 4.6 L	1999	-	1998
CADILLAC	ELDORADO	V8, 4.6 L	1998	-	2002
CADILLAC	DEVILLE	V8, 4.6 L	2002	-	2004
CADILLAC	DEVILLE	V8, 4.6 L	2005	-	2005
CADILLAC	ELDORADO	V8, 4.6 L	1995	-	1997
TOYOTA	CAMRY	4 CIL. 2.5 L	2010	-	2011

**38026**

Acero D.E. 100mm D.B. 17mm A - 28mm Lisa



CHEVROLET	CAVALIER	4 CIL. 2.2 L	1993	-	1997
CHEVROLET	CAVALIER	4 CIL. 2.0 L	1989	-	1989
PONTIAC	SUNFIRE	4 CIL. 2.2 L	1997	-	1997
PONTIAC	SUNFIRE	4 CIL. 2.2 L	1995	-	1996

**38027**

Termoplástico D.E. 82mm D.B. 17mm A - 25mm Lisa



CHEVROLET	REGAL	V6, 3.8 L	1994	-	1995
CHEVROLET	LUMINA	V6, 3.4 L	1993	-	1995
CADILLAC	REGAL	V6, 3.8 L	1995	-	1995

CHEVROLET	LUMINA	V6, 3.4 L	1996	-	1997
PONTIAC	TRANSPORT	V6, 3.8 L	1995	-	1995
OLDSMOBILE	SILHOUETTE	V6, 3.8 L	1994	-	1995

**38028**

Acero D.E. 76mm D.B. 17mm A - 37mm Lisa



FORD	SUPER DUTY PICK	V8, 7.3 L	1999	-	2002
FORD	F-450 SUPER DUTY	V8, 7.3 L	2002	-	2003
FORD	SUPER DUTY VAN	V8, 7.3 L	1999	-	2001
FORD	E SERIES VAN	V8, 7.3 L	1998	-	1998

**38029**

Termoplástico D.E. 7mm D.B. 17mm A - 28mm V-Ranurada



FORD	MUSTANG	V6, 3.8 L	1996	-	2000
------	---------	-----------	------	---	------

**38030**

Acero D.E. 70mm D.B. 17mm A - 20.5mm V-Ranurada



HONDA	CIVIC	4 CIL. 1.6 L	1997	-	1999
HONDA	CIVIC	4 CIL. 1.6 L	1998	-	1998
HONDA	CR-V	4 CIL. 2.0 L	1999	-	2001
ACURA	INTEGRA	4 CIL. 1.8 L	1999	-	1999
SUBARU	FORESTER	4 CIL. 2.5 L	2007	-	2007
SUBARU	OUTBACK	4 CIL. 2.5 L	2006	-	2006
SUBARU	LEGACY	4 CIL. 2.5 L	2006	-	2007
SUBARU	IMPREZA	4 CIL. 2.5 L	2006	-	2007

SUBARU	FORESTER	4 CIL. 2.5 L	2006	-	2006
--------	----------	--------------	------	---	------

**38031**

Acero D.E. 70mm D.B. 12mm A - 20.5mm V-Ranurada



TOYOTA	4 RUNNER	4 CIL. 2.7 L	2000	-	2000
--------	----------	--------------	------	---	------

TOYOTA	4 RUNNER	V6, 3.4 L	2002	-	2002
--------	----------	-----------	------	---	------

**38032**

Termoplástico D.E. 76mm D.B. 17mm A - 22mm Lisa



CHEVROLET	CAVALIER Z24	4 CIL. 2.4 L	1998	-	2002
-----------	--------------	--------------	------	---	------

FORD	TOPAZ	4 CIL. 2.3 L	1994	-	1994
------	-------	--------------	------	---	------

CHEVROLET	CAVALIER	4 CIL. 2.4 L	1999	-	2002
-----------	----------	--------------	------	---	------

PONTIAC	SUNFIRE	4 CIL. 2.4 L	1999	-	2002
---------	---------	--------------	------	---	------

**38033**

Acero D.E. 90mm D.B. 17mm A - 33mm Lisa



DODGE	RAM SERIES PICK	V6, 3.9 L	1995	-	2001
-------	-----------------	-----------	------	---	------

JEEP	GRAND CHEROKE	V8, 5.2 L	1995	-	1998
------	---------------	-----------	------	---	------

DODGE	RAM SERIES PICK	V8, 5.9 L	1995	-	2002
-------	-----------------	-----------	------	---	------

DODGE	VIPER	V10, 8.0 L	1998	-	2002
-------	-------	------------	------	---	------

DODGE	DURANGO	V6, 3.9 L	1998	-	1999
-------	---------	-----------	------	---	------

DODGE	RAM SERIES PICK	V10, 8.0 L	1999	-	2003
-------	-----------------	------------	------	---	------

DODGE	B SERIES VAN	V6, 3.9 L	2003	-	2003
-------	--------------	-----------	------	---	------

DODGE	DURANGO	V8, 5.2 L	1998	-	2000
-------	---------	-----------	------	---	------

JEEP	GRAND CHEROKE	V8, 5.9 L	1998	-	1998
------	---------------	-----------	------	---	------

DODGE	DURANGO	V8, 5.9 L	2002	-	2001
-------	---------	-----------	------	---	------

DODGE	RAM SERIES PICK	V8, 5.2 L	1995	-	2001
-------	-----------------	-----------	------	---	------

**38034**

Termoplástico D.E. 27mm D.B. 12mm A - 29mm V-Ranurada



CHRYSLER	GRAND VOYAGER	V6, 3.3 L	2000	-	2000
----------	---------------	-----------	------	---	------

CHRYSLER	VOYAGER	V6, 3.3 L	2000	-	2000
----------	---------	-----------	------	---	------

CHEVROLET	ASTRO	4 CIL. 2.5 L	1989	-	1989
-----------	-------	--------------	------	---	------

DODGE	CARAVAN	V6, 3.3 L	1995	-	2000
-------	---------	-----------	------	---	------

**38035**



FORD	MUSTANG	4 CIL. 2.3 L	1986	-	1985
------	---------	--------------	------	---	------

MERCURY	CAPRI	4 CIL. 2.3 L	1986	-	1981
---------	-------	--------------	------	---	------

**38036**

Acero D.E. 81mm D.B. 12mm A - 17.5mm V-Ranurada



NISSAN	PICK-UP	4 CIL. 2.4 L	1993	-	1997
--------	---------	--------------	------	---	------

**38037**

Acero D.E. 81mm D.B. 17mm A - 18mm V-Ranurada





NISSAN	XTERRA	4 CIL. 2.4 L	2001 - 2004
NISSAN	FRONTIER	4 CIL. 2.4 L	1999 - 2002
NISSAN	FRONTIER	4 CIL. 2.4 L	2003 - 2004
NISSAN	XTERRA	4 CIL. 2.4 L	2000 - 2000

**38038**



FORD	BRONCO	V8, 5.8 L	1995 - 1995
------	--------	-----------	-------------

**38039**



FORD	E SERIES VAN	V8, 6.6 L	1982 - 1981
FORD	E SERIES VAN	V8, 5.0 L	1985 - 1981
FORD	BRONCO	V8, 5.0 L	1983 - 1981
FORD	F SERIES PICKUP	V8, 5.0 L	1986 - 1981
FORD	RANGER	4 CIL. 2.3 L	1983 - 1983
FORD	F SERIES PICKUP	V8, 5.8 L	1986 - 1981
FORD	E SERIES VAN	6 CIL. 4.9 L	1986 - 1983
FORD	E SERIES VAN	V8, 5.8 L	1986 - 1982
FORD	MUSTANG	V8, 5.0 L	1985 - 1984
FORD	F SERIES PICKUP	V8, 6.6 L	1982 - 1981
FORD	THUNDERBIRD	V8, 5.0 L	1981 - 1981
FORD	F SERIES PICKUP	6 CIL. 4.9 L	1986 - 1983
FORD	BRONCO FULL SIZ	V8, 5.8 L	1984 - 1984
FORD	BRONCO FULL SIZ	V8, 5.0 L	1986 - 1984
FORD	BRONCO	V8, 5.8 L	1983 - 1981

**38040**

Acero D.E. 123mm D.B. 12mm A - 18.5mm V-Ranurada



CHRYSLER	300M	V6, 3.5 L	1999 - 2004
DODGE	INTREPID	V6, 3.2 L	1998 - 2001
CHRYSLER	CONCORDE	V6, 3.2 L	1998 - 2001
CHRYSLER	NEW YORKER	V6, 3.5 L	1994 - 1996
CHRYSLER	CONCORDE	V6, 3.5 L	1993 - 2002
DODGE	INTREPID	V6, 3.5 L	2002 - 2001
CHRYSLER	300M	V6, 3.5 L	2003 - 2003

**38041**

Acero D.E. 76mm D.B. 17mm A - 30.5mm Lisa



CADILLAC	DEVILLE	V8, 4.6 L	1998 - 2002
CADILLAC	SEVILLE	V8, 4.6 L	2003 - 2004
CADILLAC	DTS	V8, 4.6 L	2006 - 2007
CADILLAC	ELDORADO	V8, 4.6 L	1998 - 2002
CADILLAC	DEVILLE	V8, 4.6 L	2005 - 2005
CADILLAC	DEVILLE	V8, 4.6 L	2003 - 2004
CADILLAC	SEVILLE	V8, 4.6 L	1998 - 2002
CHEVROLET	CAMARO Z28	V8, 5.7 L	2000 - 2002

**38042**

Acero D.E. 90mm D.B. 10mm A - 30mm Lisa



CHRYSLER	CIRRUS	V6, 2.5 L	1996 - 2000
----------	--------	-----------	-------------

CHRYSLER	CIRRUS	V6, 2.5 L	1998	-	1999
DODGE	RAM 1500	V6, 3.7 L	2002	-	2005
CHRYSLER	CIRRUS	4 CIL. 2.0 L	2000	-	2000
DODGE	RAM 2500	V8, 4.7L	2002	-	2003
CHRYSLER	CIRRUS	4 CIL. 2.4 L	1999	-	1999
CHRYSLER	CIRRUS	4 CIL. 2.4 L	1997	-	2000
CHRYSLER	CIRRUS	4 CIL. 2.4 L	1995	-	1996
DODGE	SPIRIT	V6, 3.0 L	1994	-	1994
CHRYSLER	VOYAGER	V6, 3.0 L	2000	-	2000
CHRYSLER	VOYAGER	V6, 3.3 L	2000	-	2000
CHRYSLER	GRAND VOYAGER	V6, 3.3 L	2000	-	2000
JEEP	GRAND CHEROKE	V8, 4.7 L	2002	-	2003
JEEP	GRAND CHEROKE	6 CIL. 4.0 L	1996	-	1996
CHRYSLER	SEBRING	V6, 2.5 L	1996	-	2000
JEEP	GRAND CHEROKE	6 CIL. 4.0 L	1998	-	1998
CHRYSLER	SEBRING	4 CIL. 2.4 L	1996	-	1999
DODGE	INTREPID	V6, 3.2 L	1998	-	2001
DODGE	INTREPID	V6, 3.5 L	2002	-	2001
CHRYSLER	NEW YORKER	V6, 3.8 L	1993	-	1993
CHRYSLER	NEW YORKER	V6, 3.5 L	1994	-	1996
CHRYSLER	NEW YORKER	V6, 3.3 L	1993	-	1993
CHRYSLER	LEBARON	V6, 3.0 L	1993	-	1995
DODGE	CARAVAN	4 CIL. 2.4 L	1997	-	1997
CHRYSLER	CONCORDE	V6, 3.2 L	1998	-	2001
DODGE	DURANGO	V8, 4.7 L	2004	-	2004
CHRYSLER	CONCORDE	V6, 3.5 L	1993	-	2002
DODGE	CARAVAN	V6, 3.3 L	1995	-	1999
DODGE	CARAVAN	V6, 3.3 L	2000	-	2000
JEEP	GRAND CHEROKE	6 CIL. 4.0 L	1994	-	1997
JEEP	CHEROKEE	4 CIL. 2.5 L	1995	-	1998
JEEP	CHEROKEE	6 CIL. 4.0 L	1995	-	2001
DODGE	ADVENTURER	V6, 3.3 L	1993	-	2000
DODGE	STRATUS	V6, 2.5 L	1995	-	2000
DODGE	STRATUS	4 CIL. 2.4 L	1995	-	2000
DODGE	STRATUS	4 CIL. 2.0 L	1996	-	2000
DODGE	STRATUS	4 CIL. 2.0 L	1995	-	1995
CHRYSLER	CIRRUS	V6, 2.5 L	1995	-	1995

DODGE	CARAVAN	V6, 3.0 L	1995	-	1995
JEEP	WRANGLER	6 CIL. 4.0 L	1997	-	1999
JEEP	WRANGLER	4 CIL. 2.5 L	1995	-	2002
CHRYSLER	300M	V6, 3.5 L	1999	-	2004
DODGE	DURANGO	V8, 4.7 L	2002	-	2003
JEEP	LIBERTY	V6, 3.7 L	2005	-	2005
DODGE	RAM SERIES PICK	V8, 4.7L	2002	-	2003
JEEP	LIBERTY	V6, 3.7 L	2002	-	2003
DODGE	RAM SERIES PICK	V6, 3.7 L	2002	-	2003
CHRYSLER	300M	V6, 3.5 L	2003	-	2003
JEEP	LIBERTY	V6, 3.7 L	2006	-	2007
JEEP	WRANGLER	4 CIL. 2.5 L	1993	-	1998

**38043**

Acero D.E. 76mm D.B. 10mm A - 30mm Lisa



CHRYSLER	VOYAGER	V6, 3.3 L	2001	-	2003
CHRYSLER	TOWN & COUNTRY	V6, 3.8 L	2005	-	2007
CHRYSLER	CONCORDE	V6, 2.7 L	1999	-	2000
JEEP	GRAND CHEROKE	V6, 4.0 L	2003	-	2003
CHEVROLET	MALIBU	V6, 3.5 L	2004	-	2006
CHRYSLER	TOWN & COUNTRY	V6, 3.8 L	2002	-	2003
CHEVROLET	UPLANDER	V6, 3.5 L	2005	-	2006
DODGE	CARAVAN	V6, 3.3 L FLEX	2001	-	2003
DODGE	CARAVAN	V6, 3.3 L	2002	-	2006
JEEP	GRAND CHEROKE	6 CIL. 4.0 L	1998	-	2001
JEEP	CHEROKEE	4 CIL. 2.5 L	1997	-	1998
DODGE	CARAVAN	V6, 3.3 L	2007	-	2007
CHEVROLET	EQUINOX	V6, 3.4 L	2005	-	2007
JEEP	CHEROKEE	6 CIL. 4.0 L	1997	-	1999
JEEP	WRANGLER	6 CIL. 4.0 L	1999	-	2006
JEEP	WRANGLER	4 CIL. 2.5 L	2002	-	2002
CHEVROLET	VENTURE	V6, 3.4 L	2002	-	2005
JEEP	WRANGLER	4 CIL. 2.5 L	1997	-	2002

JEEP	WRANGLER	6 CIL. 4.0 L	2002	-	2002
CHRYSLER	TOWN & COUNTRY	V6, 3.8 L	2001	-	2001
CHRYSLER	VOYAGER	V6, 3.3 L	2002	-	2002
CHRYSLER	VOYAGER	V6, 3.3 L	2003	-	2007
CHEVROLET	MALIBU	V6, 3.1 L	2002	-	2003
DODGE	INTREPID	V6, 2.7 L	2001	-	2001
PONTIAC	TORRENT	V6, 3.4 L	2006	-	2008
PONTIAC	MONTANA	V6, 3.5 L	2006	-	2006
PONTIAC	AZTEK	V6, 3.4 L	2003	-	2005
SATURN	RELAY	V6, 3.5 L	2006	-	2005
PONTIAC	G6	V6, 3.5 L	2006	-	2006

BMW	740IL	V8, 4.0 L	1995	-	1993
-----	-------	-----------	------	---	------

**38046**



BMW	740I	V8, 4.0 L	1994	-	1993
BMW	740IL	V8, 4.0 L	1994	-	1993
BMW	530I	V8, 3.0 L	1995	-	1994

**38047**



**38044**

Acero D.E. 80mm D.B. 17mm A - 21.8mm V-Ranurada



NISSAN	QUEST	V6, 3.0 L	1997	-	1998
NISSAN	QUEST	V6, 3.3 L	1999	-	2000
NISSAN	ALTIMA	4 CIL. 2.4 L	1998	-	1998
NISSAN	ALTIMA	4 CIL. 2.4 L	1999	-	2001

**38045**



MERCEDES-BE	300SEL	6 CIL. 3.0 L	1991	-	1990
MERCEDES-BE	S320	6 CIL. 3.2 L	1999	-	1994
MERCEDES-BE	300E	6 CIL. 2.6 L	1992	-	1990
MERCEDES-BE	C280	6 CIL. 2.8 L	1997	-	1995
MERCEDES-BE	E320	6 CIL. 3.2 L	1996	-	1994
MERCEDES-BE	300SL	6 CIL. 3.0 L	1993	-	1990
MERCEDES-BE	300SE	6 CIL. 3.0 L	1991	-	1988
MERCEDES-BE	300E	6 CIL. 3.0 L	1992	-	1986
MERCEDES-BE	SL320	6 CIL. 3.2 L	1996	-	1994
MERCEDES-BE	300CE	6 CIL. 3.0 L	1992	-	1988
MERCEDES-BE	300TE	6 CIL. 3.0 L	1992	-	1988
MERCEDES-BE	190E	6 CIL. 2.6 L	1992	-	1987
MERCEDES-BE	260E	6 CIL. 2.6 L	1989	-	1987

BMW	540I	V8, 4.0 L	1995	-	1994
BMW	530I	V8, 3.0 L	1995	-	1994
BMW	540I	V8, 4.4 L	1997	-	1997
BMW	840CI	V8, 4.4 L	1997	-	1996
BMW	840CI	V8, 4.0 L	1995	-	1994
BMW	740IL	V8, 4.4 L	1997	-	1996
BMW	740I	V8, 4.0 L	1995	-	1993
BMW	740I	V8, 4.4 L	1997	-	1997

**38048**



MERCEDES-BE	190D	5 CIL. 2.5 L Diesel	1989	-	1986
MERCEDES-BE	190E	4 CIL. 2.3 L	1988	-	1986
MERCEDES-BE	190D	4 CIL. 2.2 L Diesel	1985	-	1984
MERCEDES-BE	500SL	V8, 5.0 L	1993	-	1992
MERCEDES-BE	SL500	V8, 5.0 L	1997	-	1994

**38051**



FORD	ESCORT	4 CIL. 2.0 L Diesel	1987	-	1985
FORD	TEMPO	4 CIL. 2.0 L Diesel	1986	-	1985

**38052**

Acero D.E. 90mm D.B. 17mm A - 37mm V-Ranurada



FORD	E SERIES VAN	V8, 7.3 L	1997	-	1997
------	--------------	-----------	------	---	------

**38053**

Acero D.E. 76mm D.B. 17mm A - 38mm V-Ranurada



FORD	E SERIES VAN	V8, 5.4 L	1997	-	2001
FORD	F-450 SUPER DUTY	V8, 7.3 L	2002	-	2003
FORD	F SERIES PICKUP	V8, 5.4 L	1999	-	2001
FORD	E SERIES VAN	V8, 4.6 L	1999	-	2001
FORD	F-250	V8, 4.6 L	1998	-	2004
FORD	F SERIES PICKUP	V8, 4.6 L	1998	-	2001
FORD	SUPER DUTY VAN	V8, 5.4 L	1999	-	2001
FORD	SUPER DUTY VAN	V10, 6.8 L	2000	-	2001
FORD	E SERIES VAN	V10, 6.8 L	1998	-	1998
FORD	SUPER DUTY VAN	V8, 7.3 L	1999	-	2001
FORD	SUPER DUTY PICKUP	V8, 7.3 L	1999	-	2002
FORD	SUPER DUTY PICKUP	V8, 5.4 L	1999	-	2001
FORD	E SERIES VAN	V8, 7.3 L	1998	-	1998

**38049**

Acero D.E. 80mm D.B. A - 31mm Lisa



FORD	AEROSTAR	V6, 3.0 L	1994	-	1994
------	----------	-----------	------	---	------

**38050**



FORD	MUSTANG	V6, 3.8 L	1985	-	1985
FORD	THUNDERBIRD	V6, 3.8 L	1987	-	1985
MERCURY	COUGAR	V6, 3.8 L	1988	-	1985
MERCURY	CAPRI	V6, 3.8 L	1986	-	1985

**38058**

Termoplástico D.E. 76mm D.B. 17mm A - 29.5mm Lisa



CHRYSLER	ASPEN	V8, 5.7 L	2007 - 2009
DODGE	DURANGO	V8, 5.7 L	2006 - 2007
DODGE	DURANGO	V8, 5.7 L	2004 - 2005
DODGE	RAM SERIES PICK	V10, 8.0 L	1999 - 2000
DODGE	RAM SERIES PICK	V8, 5.9 L	1997 - 2001
DODGE	RAM 3500	V8, 5.7 L	2003 - 2007
DODGE	RAM 2500	V8, 5.7 L	2008 - 2008

**38061**

Termoplástico D.E. 75mm D.B. 24.5mm\* A - 24.5mm Lisa



BMW	750IL	V12, 5.4 L	1998 - 2000
-----	-------	------------	-------------

**38062**

Termoplástico D.E. 70mm D.B. 24mm\* A - 28mm Lisa



BMW	750IL	V12, 5.4 L	1998 - 2000
-----	-------	------------	-------------

**38063**

Termoplástico D.E. 70mm D.B. 17mm A - 28mm Lisa



BMW	X5	V8, 4.4 L	2000 - 2000
BMW	760LI	V12, 6.0 L	2005 - 2005
BMW	760I	V12, 6.0 L	2005 - 2005
BMW	740IL	V8, 4.4 L	1998 - 2001
BMW	745LI	V8, 4.4 L	2005 - 2005
BMW	745I	V8, 4.4 L	2005 - 2005
BMW	740I	V8, 4.4 L	1998 - 2001
BMW	540I	V8, 4.4 L	1998 - 2003
BMW	X5	V8, 4.6 L	2002 - 2002

**38064**



BMW	740I	V8, 4.0 L	1994 - 1993
BMW	740IL	V8, 4.0 L	1994 - 1993

**38065**



BMW	840CI	V8, 4.4 L	1997 - 1996
BMW	840CI	V8, 4.0 L	1995 - 1994

**38066**

Termoplástico D.E. 70mm D.B. 24mm\* A - 28mm Lisa



BMW	740IL	V8, 4.4 L	1998 - 2001
BMW	740I	V8, 4.4 L	1998 - 2001
BMW	540I	V8, 4.4 L	1998 - 2003

**38068**

Acero D.E. 60mm D.B. 25.7mm\* A - 22.5mm V-Ranurada



AUDI	A4	4 CIL. 1.8 L	1998 - 2001
VOLKSWAGEN	PASSAT	4 CIL. 1.8 L	2004 - 2004
VOLKSWAGEN	PASSAT	4 CIL. 1.8 L	1999 - 2003
VOLKSWAGEN	PASSAT	4 CIL. 1.8 L	2005 - 2005

**38070**

Termoplástico D.E. 80mm D.B. 8mm A - 21mm Lisa



BMW	Z3	4 CIL. 1.9 L	1998 - 1998
BMW	Z3	6 CIL. 3.2 L	1998 - 1998
BMW	318TI	4 CIL. 1.9 L	1998 - 1999
BMW	318I	4 CIL. 1.9 L	1998 - 1999

**38069**

Termoplástico D.E. 80mm D.B. 10.2mm A - 37mm Lisa



BMW	330XI	6 CIL. 3.0 L	2001 - 2005
BMW	325XI	6 CIL. 2.5 L	2004 - 2005
BMW	330CI	6 CIL. 3.0 L	2001 - 2003
BMW	320I	6 CIL. 2.2 L	2005 - 2005
BMW	X3	6 CIL. 3.0 L	2005 - 2006
BMW	M3	6 CIL. 3.2 L	2001 - 2002
BMW	525I	6 CIL. 2.5 L	2001 - 2005
BMW	Z4	6 CIL. 3.0 L	2003 - 2005
BMW	Z3	6 CIL. 3.2 L	1998 - 1998
BMW	Z4	6 CIL. 2.5 L	2003 - 2005
BMW	X5	6 CIL. 3.0 L	2005 - 2005
BMW	Z3	6 CIL. 2.8 L	1998 - 1998
BMW	530I	6 CIL. 3.0 L	2002 - 2002

**38071**

Termoplástico D.E. 70mm D.B. 24.5mm\* A - 24.5mm Lisa

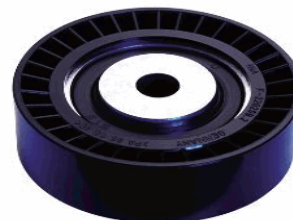

BMW	Z3	6 CIL. 2.8 L	1998 - 1998
BMW	525I	6 CIL. 2.5 L	2001 - 2005
BMW	318TI	4 CIL. 1.9 L	1998 - 1999
BMW	X5	6 CIL. 3.0 L	2006 - 2006
BMW	M3	6 CIL. 3.2 L	2001 - 2002
BMW	330CI	6 CIL. 3.0 L	2001 - 2003
BMW	318I	4 CIL. 1.9 L	1998 - 1999
BMW	328I	V6, 2.8 L	2000 - 2000
BMW	330XI	6 CIL. 3.0 L	2001 - 2005
BMW	X5	6 CIL. 3.0 L	2005 - 2005
BMW	325XI	6 CIL. 2.5 L	2004 - 2005
BMW	530I	6 CIL. 3.0 L	2002 - 2002
BMW	320I	V6, 2.2 L	2005 - 2005
BMW	320I	V6, 2.2 L	2004 - 2004
BMW	Z3	6 CIL. 3.2 L	1998 - 1998
BMW	X3	6 CIL. 3.0 L	2005 - 2006

**38073**

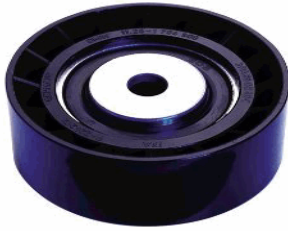

BMW	840CI	V8, 4.4 L	1997 - 1996
BMW	840CI	V8, 4.0 L	1995 - 1994
BMW	740IL	V8, 4.0 L	1995 - 1995
BMW	740IL	V8, 4.4 L	1997 - 1996
BMW	740I	V8, 4.4 L	1997 - 1997
BMW	540I	V8, 4.0 L	1995 - 1995
BMW	540I	V8, 4.4 L	1997 - 1997
BMW	740I	V8, 4.0 L	1995 - 1995

**38078**



AUDI	CABRIOLET	V6, 2.8 L	1998 - 1998
------	-----------	-----------	-------------

**38079**



VOLKSWAGEN	EUROVAN	5 CIL. 2.5 L	1996 - 1996
------------	---------	--------------	-------------

**38074**

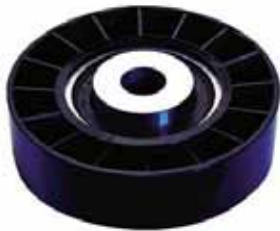

SAAB	9000	4 CIL. 2.3 L	1998 - 1990
------	------	--------------	-------------

**38080**



VOLKSWAGEN	EUROVAN	5 CIL. 2.5 L	1996 - 1996
------------	---------	--------------	-------------

**38077**



SAAB	9000	4 CIL. 2.0 L	1990 - 1986
SAAB	9000	4 CIL. 2.3 L	1998 - 1990

**38081**



SAAB	9000	V6, 3.0 L	1997 - 1995
------	------	-----------	-------------

**38082**

Termoplástico D.E. 63.5mm D.B. 17 mm A - 26.5mm V-Ranurada



DODGE	CHARGER	V6, 3.5 L	2009	-	2009
CHRYSLER	300 C	V6, 3.5 L	2007	-	2009
CHRYSLER	CROSSFIRE	V6, 3.2 L	2004	-	2005
DODGE	CHARGER	V6, 3.5 L	2007	-	2008
MERCEDES-BE	C320	V6, 3.2 L	2002	-	2005
MERCEDES-BE	C320	V6, 3.2 L	2001	-	2004
MERCEDES-BE	CL500	V8, 5.0 L	2000	-	2001
MERCEDES-BE	CL500	V8, 5.0 L	2002	-	2005
MERCEDES-BE	CL55	V8, 5.5 L	2001	-	2006
MERCEDES-BE	CLK320	V6, 3.2 L	2001	-	2004
MERCEDES-BE	C240	V6, 2.6 L	2001	-	2005
MERCEDES-BE	CLK430	V8, 4.3 L	2000	-	2001
MERCEDES-BE	E320	V6, 3.2 L	2001	-	2006
MERCEDES-BE	CLK500	V8, 5.0 L	2003	-	2005
MERCEDES-BE	CLK55	V8, 5.5 L	2002	-	2005
MERCEDES-BE	CLK430	V8, 4.3 L	2002	-	2003
MERCEDES-BE	C280	V6, 2.8 L	1998	-	2000
MERCEDES-BE	ML320	V6, 3.2 L	2001	-	2003
MERCEDES-BE	SLK350	V6, 3.5 L	2005	-	2005
MERCEDES-BE	SL500	V8, 5.0 L	2001	-	2005
MERCEDES-BE	S55	V8, 5.5 L	2001	-	2002
MERCEDES-BE	SLK320	V6, 3.2 L	2001	-	2004
MERCEDES-BE	CLK320	V6, 3.2 L	2005	-	2005
MERCEDES-BE	S430	V8, 4.3 L	2001	-	2005
MERCEDES-BE	E430	V8, 4.3 L	2001	-	2001
MERCEDES-BE	E55	V8, 5.5 L	2001	-	2002
MERCEDES-BE	S500	V8, 5.0 L	2001	-	2005

**38083**

Termoplástico D.E. 64mm D.B. 8.2mm A - 23mm V-Ranurada



SAAB	9 - 5	4 CIL. 2.3 L	2000	-	2000
------	-------	--------------	------	---	------

**38084**



MERCEDES-BE	500SL	V8, 5.0 L	1992	-	1990
-------------	-------	-----------	------	---	------

**38087**

Termoplástico D.E. 78mm D.B. 9mm A - 25mm Lisa



VOLKSWAGEN	GOLF	4 CIL. 2.0 L	1995	-	2000
VOLKSWAGEN	JETTA	4 CIL. 2.0 L	1995	-	2000
VOLKSWAGEN	CABRIO	4 CIL. 2.0 L	1995	-	2002
VOLKSWAGEN	PASSAT	4 CIL. 2.0 L	1995	-	1996
VOLKSWAGEN	JETTA	4 CIL. 2.0 L	1994	-	1994

**38088**



VOLKSWAGEN	GOLF	4 CIL. 1.6 L Diesel (Canar)	1992	-	1988
VOLKSWAGEN	JETTA	4 CIL. 1.6 L Diesel	1992	-	1985



VOLKSWAGEN	PASSAT	4 CIL. 2.0 L	1993	-	1992
VOLKSWAGEN	GOLF	4 CIL. 1.6 L Diesel	1987	-	1985
VOLKSWAGEN	PASSAT	4 CIL. 2.0 L (Canada)	1994	-	1994
VOLKSWAGEN	JETTA	4 CIL. 1.6 L Diesel (Cana)	1988	-	1987

**38090**

Termoplástico D.E. 63.5mm D.B. 14.5mm\* A - 31mm V-Ranurada

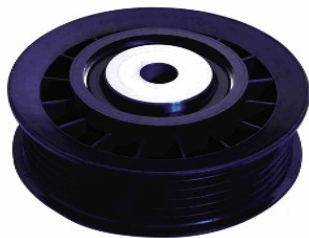

MERCEDES-BE	SL600	V12, 6.0 L	2001	-	2001
-------------	-------	------------	------	---	------

**38091**



MERCEDES-BE	S600	V12, 6.0 L	1999	-	1994
MERCEDES-BE	SL600	V12, 6.0 L	1999	-	1994

**38092**



MERCEDES-BE	300SEL	6 CIL. 3.0 L	1989	-	1988
MERCEDES-BE	260E	6 CIL. 2.6 L	1989	-	1987
MERCEDES-BE	300E	6 CIL. 3.0 L	1992	-	1986
MERCEDES-BE	300E	6 CIL. 2.6 L	1992	-	1990
MERCEDES-BE	300SE	6 CIL. 3.0 L	1991	-	1988
MERCEDES-BE	300CE	6 CIL. 3.0 L	1992	-	1988
MERCEDES-BE	190E	6 CIL. 2.6 L	1987	-	1987

**38093**

Termoplástico D.E. 85mm D.B. 14.5mm\* A - 30mm Lisa



AUDI	A8	V8, 3.7 L	1998	-	1998
AUDI	A8 QUATTRO	V8, 4.2 L	1999	-	2000
AUDI	A8	V8, 4.2 L	2000	-	2000
AUDI	A8	V8, 3.7 L	1999	-	1999
AUDI	A8	V8, 4.2 L	1999	-	1999
AUDI	A6	V8, 4.2 L	2004	-	2004
AUDI	A8	V8, 4.2 L	2001	-	2006

**38099**

Termoplástico D.E. 69.7mm D.B. 17mm A - 29mm V-Ranurada

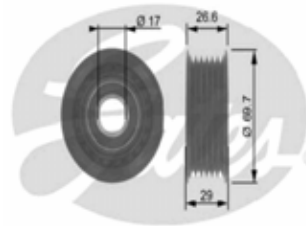

MERCEDES-BE	VITO	4 CIL. 2.2 L	2008	-	2010
MERCEDES-BE	SPRINTER	5 CIL. 2.7 L CDI	2003	-	2005
MERCEDES-BE	SPRINTER	4 CIL. 2.2 L CDI	2008	-	2010
MERCEDES-BE	SPRINTER	4 CIL. 2.2 L CDI	2006	-	2007

**38102**

Termoplástico V-Ranurada 6 costillas (70 mm x 17 mm x 25 mm)



FORD	RANGER	V6, 4.0 L	1999	-	2000
LAND ROVER	DISCOVERY	V8, 4.0 L	2000	-	2004
FORD	AEROSTAR	V6, 4.0 L	1996	-	1997
FORD	EXPLORER	V6, 4.0 L	1995	-	2000
MERCURY	MOUNTAINEER	V6, 4.0 L	1998	-	1999

**38103**

Termoplástico V-Ranurada 6 costillas (70 mm x 17 mm x 25 mm)



GMC	JIMMY	V6, 4.3 L	2005	-	2000
CHEVROLET	SUBURBAN	V8, 7.4 L	1996	-	1999
CHEVROLET	SILVERADO	V6, 4.3 L	1999	-	2002
GMC	SONOMA	V6, 4.3 L	2004	-	2000
CHEVROLET	EXPRESS	V8, 5.7 L	1996	-	2001

CHEVROLET	C & K SERIES PICK	V8, 5.0 L	1997	-	1999
CHEVROLET	S-10	V6, 4.3 L	1996	-	2002
CHEVROLET	EXPRESS CARGO	V6, 4.3 L	2007	-	2007
CHEVROLET	BLAZER	V6, 4.3 L	2003	-	2003
CHEVROLET	EXPRESS	V8, 5.7 L	2002	-	2002
GMC	SAVANA	V6, 4.3 L	2007	-	2000
GMC	SAFARI	V6, 4.3 L	2005	-	2000
CHEVROLET	EXPRESS CARGO	V6, 4.3 L	2008	-	2010
CHEVROLET	EXPRESS CARGO	V6, 4.3 L	2005	-	2006
CHEVROLET	C-2500	V8, 5.7 L	1996	-	2000
CHEVROLET	SILVERADO PICKU	V6, 4.3 L	2004	-	2004
CHEVROLET	EXPRESS	V8, 5.0 L	1996	-	2002
CHEVROLET	BLAZER	V6, 4.3 L	1996	-	2002
CHEVROLET	EXPRESS	V8, 7.4 L	1996	-	2000
CHEVROLET	SILVERADO	V6, 4.3 L	2003	-	2007
CHEVROLET	C & K SERIES PICK	V8, 5.7 L	1996	-	2000
CADILLAC	ESCALADE	V8, 5.7 L	1999	-	2000
CHEVROLET	SUBURBAN	V8, 5.7 L	1996	-	1999
CHEVROLET	EXPRESS	V6, 4.3 L	1996	-	2001
CHEVROLET	C & K SERIES PICK	V6, 4.3 L	1996	-	1998
GMC	SAVANA	V8, 5.7 L	2002	-	2000
CHEVROLET	BLAZER	V6, 4.3 L	2005	-	2005
CHEVROLET	BLAZER	V6, 4.3 L	2004	-	2004
CHEVROLET	C & K SERIES PICK	V8, 7.4 L	1999	-	2000
GMC	SAVANA	V8, 7.4 L	2000	-	2000
CHEVROLET	EXPRESS	V6, 4.3 L	2002	-	2003
CHEVROLET	C-3500	V8, 5.7 L	1996	-	2000
CHEVROLET	SILVERADO	V6, 4.3 L	2008	-	2010
CHEVROLET	SILVERADO PICKU	V6, 4.3 L	1999	-	2006
GMC	SAVANA	V8, 5.0 L	2002	-	2000

**38104**

Termoplástico V-Ranurada 6 costillas (76 mm x 17 mm x 25 mm)



CHEVROLET	MALIBU	V6, 3.5 L	2006	-	2006
CHEVROLET	EQUINOX	V6, 3.4 L	2005	-	2006
CHEVROLET	VENTURE	V6, 3.4 L	2002	-	2005
CHEVROLET	EQUINOX	V6, 3.4 L	2007	-	2007
CHEVROLET	VENTURE	V6, 3.4 L	1999	-	2001
CHEVROLET	CUTLASS	V6, 3.1 L	1998	-	1998
CHEVROLET	UPLANDER	V6, 3.5 L	2006	-	2007
CHEVROLET	UPLANDER	V6, 3.5 L	2005	-	2005
CHEVROLET	CUTLASS	V6, 3.1 L	1997	-	1997
CHEVROLET	MALIBU	V6, 3.5 L	2004	-	2005
CHEVROLET	MALIBU	V6, 3.1 L	1997	-	2001
CHEVROLET	MALIBU	V6, 3.1 L	2002	-	2003
SATURN	RELAY	V6, 3.5 L	2005	-	2006
PONTIAC	AZTEK	V6, 3.4 L	2002	-	2005
PONTIAC	GRAND AM	V6, 3.4 L	1999	-	2001
PONTIAC	GRAND AM	V6, 3.4 L	2002	-	2005
PONTIAC	G6	V6, 3.9 L	2006	-	2006
PONTIAC	G6	V6, 3.5 L	2006	-	2006
PONTIAC	TRANS SPORT	V6, 3.4 L	1999	-	1999
PONTIAC	AZTEK	V6, 3.4 L	2001	-	2001
PONTIAC	MONTANA	V6, 3.5 L	2006	-	2006
PONTIAC	TORRENT	V6, 3.4 L	2006	-	2008

**38105**

Termoplástico Lisa/Posterior (90 mm x 17 mm x 25.5 mm)



CHEVROLET	VENTURE	V6, 3.4 L	1997	-	1998
CHEVROLET	MONTE CARLO	V6, 3.4 L	2005	-	2005
CHEVROLET	LUMINA	V6, 3.4 L	1993	-	1995
CHEVROLET	CAVALIER	V6, 3.1 L	1993	-	1994
CHEVROLET	IMPALA	V6, 3.4 L	2003	-	2003
CHEVROLET	CAVALIER	V6, 2.8 L	1989	-	1989
CHEVROLET	IMPALA	V6, 3.4 L	2000	-	2002
CHEVROLET	LUMINA	V6, 3.1 L	1996	-	1997
CHEVROLET	CENTURY	V6, 3.1 L	1994	-	1999
CHEVROLET	IMPALA	V6, 3.4 L	2004	-	2005
CHEVROLET	CUTLASS	V6, 3.1 L	1993	-	1996
CHEVROLET	MONTE CARLO	V6, 3.4 L	2004	-	2004
OLDSMOBILE	SILHOUETTE	V6, 3.4 L	1996	-	1996
PONTIAC	GRAND PRIX	V6, 3.1 L	1997	-	2002
PONTIAC	TRANS SPORT	V6, 3.1 L	1995	-	1995
PONTIAC	GRAND AM	V6, 3.1 L	1997	-	1997
PONTIAC	TRANS SPORT	V6, 3.4 L	1996	-	1997

**38107**



CHEVROLET	ASTRO	V6, 4.3 L	1995	-	1995
-----------	-------	-----------	------	---	------

**38108**

Acero Lisa/Posterior (90 mm x 17 mm x 30.5 mm)



CHEVROLET	S-10	V6, 4.3 L	1995	-	1995
CHEVROLET	BLAZER	V6, 4.3 L	1993	-	1994
CHEVROLET	S-10	V6, 4.3 L	1993	-	1994
CHEVROLET	C-2500	V8, 5.7 L	1993	-	1995
CHEVROLET	SUBURBAN	V8, 5.7 L	1993	-	1995
CHEVROLET	C-35	V8, 5.7 L	1993	-	1993
CHEVROLET	ASTRO	V6, 4.3 L	1989	-	1989
CHEVROLET	C-20	V8, 5.7 L	1991	-	1990
CHEVROLET	C & K SERIES PICK	V6, 4.3 L	1995	-	1995
CHEVROLET	BLAZER	V6, 4.3 L	1995	-	1995
CHEVROLET	C-3500	V8, 5.7 L	1994	-	1995
CHEVROLET	C-30	V8, 5.7 L	1991	-	1993
CHEVROLET	C & K SERIES PICK	V8, 5.7 L	1993	-	1995

**38106**



CHEVROLET	ASTRO	V6, 4.3 L	1995	-	1995
-----------	-------	-----------	------	---	------

**38109**

Acero Lisa/Posterior (100 mm x 17 mm x 28 mm)



CHEVROLET	CAVALIER	4 CIL. 2.0 L	1989	-	1989
CHEVROLET	CAVALIER	4 CIL. 2.2 L	1993	-	1994

**38110**

Acero Lisa/Posterior (100 mm x 17 mm x 28 mm)



CHEVROLET	CAVALIER	4 CIL. 2.2 L	1995 - 1997
PONTIAC	SUNFIRE	4 CIL. 2.2 L	1996 - 1997
PONTIAC	SUNFIRE	4 CIL. 2.2 L	1995 - 1995

CHRYSLER	TOWN & COUNTRY	V6, 3.8 L	1999 - 2000
DODGE	ADVENTURER	V6, 3.3 L	1993 - 2000
CHRYSLER	GRAND VOYAGER	V6, 3.8 L	1994 - 1999
CHRYSLER	GRAND VOYAGER	V6, 3.3 L	2000 - 2000
CHRYSLER	TOWN & COUNTRY	V6, 3.8 L	1995 - 1995
DODGE	CARAVAN	V6, 3.3 L	2000 - 2000
DODGE	CARAVAN	V6, 3.3 L	1995 - 1999

**38111**



CHEVROLET	CELEBRITY	4 CIL. 2.5 L	1989 - 1989
-----------	-----------	--------------	-------------

**38112**



SATURN	S-SERIES	4 CIL. 1.9 L	2002 - 2002
--------	----------	--------------	-------------

**38113**

Termoplástico Lisa/Posterior (90 mm x 17 mm x 30.5 mm)

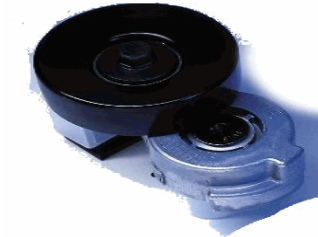

CHRYSLER	VOYAGER	V6, 3.3 L	1996 - 2000
CHRYSLER	VOYAGER	V6, 3.8 L	1999 - 1999
CHRYSLER	NEW YORKER	V6, 3.3 L	1993 - 1993
CHRYSLER	NEW YORKER	V6, 3.8 L	1993 - 1993

**38114**

Acero Lisa/Posterior (76 mm x 17 mm x 30.5 mm)



FORD	AEROSTAR	V6, 3.0 L	1995 - 1997
FORD	RANGER	V6, 3.0 L	1996 - 2001
FORD	WINDSTAR	V6, 3.0 L	1998 - 1998
FORD	RANGER	V6, 3.0 L	2002 - 2002
MERCURY	SABLE / TAURUS	V6, 3.0 L	2002 - 2002
MERCURY	SABLE / TAURUS	V6, 3.0 L	1999 - 2005
MERCURY	SABLE / TAURUS	V6, 3.0 L	1996 - 2001

**38115**



FORD	F SERIES PICKUP	V8, 5.0 L	1992 - 1992
------	-----------------	-----------	-------------

**38116**

Termoplástico V-Ranurada 7 costillas (76 mm x 17 mm x 32 mm)



DODGE	RAM 2500	V8, 5.9 L	1994 - 2002
-------	----------	-----------	-------------

DODGE	RAM 1500	V6, 3.9 L	1994	-	2001
DODGE	RAM 2500	V8, 5.2 L	1997	-	2001
DODGE	RAM MAXI VAN 1500	V6, 3.9 L	1999	-	1999
DODGE	RAM MAXI VAN 1500	V6, 3.9 L	2002	-	2002
DODGE	D-150	V6, 3.9 L	1993	-	1993
DODGE	RAM 4000	V8, 5.9 L	1995	-	2002
DODGE	RAM 3500	V8, 5.9 L	1994	-	2002
DODGE	RAM CHARGER	V8, 5.9 L	1993	-	1993
DODGE	DURANGO	V8, 5.9 L	1998	-	2003
DODGE	D-250	V8, 5.9 L	1993	-	1993
DODGE	RAM WAGON 3500	V8, 5.9 L	2002	-	2002
DODGE	RAM WAGON 2500	V8, 5.9 L	1994	-	1995
DODGE	RAM WAGON 2500	V8, 5.2 L	1997	-	2001
DODGE	RAM WAGON 1500	V8, 5.2 L	1997	-	2001
DODGE	RAM SERIES PICKUP	V8, 5.9 L	1994	-	2001
DODGE	B SERIES VAN	V6, 3.9 L	2003	-	2003
DODGE	RAM SERIES PICKUP	V8, 5.9 L	2002	-	2002
DODGE	RAM SERIES PICKUP	V8, 5.2 L	1995	-	2001
DODGE	RAM MAXI WAGON	V8, 5.9 L	1996	-	2001
DODGE	RAM SERIES PICKUP	V6, 3.9 L	1994	-	2001
DODGE	RAM MAXI VAN 2500	V8, 5.2 L	2002	-	2002
JEEP	GRAND CHEROKEE	V8, 5.2 L	1993	-	1998
DODGE	D-350	V8, 5.9 L	1993	-	1993
DODGE	RAM MAXI WAGON	V8, 5.9 L	2002	-	2002
DODGE	RAM MAXI WAGON	V8, 5.2 L	1996	-	1996
DODGE	DURANGO	V6, 3.9 L	1998	-	1999
DODGE	RAM MAXI VAN 3500	V8, 5.9 L	1996	-	2001
DODGE	RAM MAXI VAN 3500	V8, 5.9 L	2002	-	2002
DODGE	RAM MAXI VAN 2500	V8, 5.2 L	1996	-	2001
DODGE	DURANGO	V8, 5.2 L	1998	-	2000
JEEP	GRAND CHEROKEE	V8, 5.9 L	1998	-	1998

**38117**



FORD	TOPAZ	4 CIL. 2.3 L	1991	-	1991
------	-------	--------------	------	---	------

**38118**

Acero Lisa/Posterior (76 mm x 17 mm x 30.5 mm)



GMC	SAVANA	V8, 6.5 L	2002	-	2000
CHEVROLET	EXPRESS	V8, 6.5 L	1999	-	2002
CHEVROLET	C & K SERIES PICKUP	V8, 6.5 L	1999	-	2002

**38119**

Acero Lisa/Posterior (90 mm x 17 mm x 37.5 mm)



FORD	E SERIES VAN	V8, 7.3 L	1997	-	1997
------	--------------	-----------	------	---	------

**38120**



BUICK	REGAL	V6, 3.8 L	1991	-	1990
BUICK	RIVIERA	V6, 3.8 L	1991	-	1988
BUICK	ELECTRA	V6, 3.8 L	1990	-	1988
BUICK	LESABRE	V6, 3.8 L	1991	-	1988

BUICK	REATA	V6, 3.8 L	1991	-	1988
OLDSMOBILE	NINETY EIGHT	V6, 3.8 L	1991	-	1988
PONTIAC	BONNEVILLE	V6, 3.8 L	1991	-	1989
OLDSMOBILE	TORONADO	V6, 3.8 L	1991	-	1988
OLDSMOBILE	EIGHTY EIGHT	V6, 3.8 L	1991	-	1989

**38121**



FORD	MUSTANG	V8, 5.0 L	1984	-	1984
------	---------	-----------	------	---	------

**38122**

Termoplástico Lisa/Posterior (90 mm x 17 mm x 30.5 mm)



DODGE	CARAVAN	V6, 3.0 L	1995	-	1995
CHRYSLER	LEBARON	V6, 3.0 L	1993	-	1995
CHRYSLER	DAYTONA	V6, 3.0 L	1993	-	1993
CHRYSLER	VOYAGER	V6, 3.0 L	2000	-	2000
DODGE	SPIRIT	V6, 3.0 L	1994	-	1994

**38123**

Acero Lisa/Posterior (76 mm x 17 mm x 30.5 mm)



FORD	F SERIES PICKUP	V8, 5.8 L	1995	-	1997
FORD	F-250	V8, 5.0 L	1993	-	1996
FORD	F SERIES PICKUP	V8, 5.0 L	1995	-	1996
FORD	F-350 SUPER DUTY	V8, 5.0 L	1993	-	1996
FORD	BRONCO	V8, 5.0 L	1996	-	1996

FORD	F-350 SUPER DUTY	V8, 5.8 L	1993	-	1997
------	------------------	-----------	------	---	------

**38124**



CHRYSLER	DAYTONA	V6, 3.0 L	1990	-	1990
----------	---------	-----------	------	---	------

**38125**



FORD	TAURUS	V6, 3.0 L	1992	-	1988
MERCURY	SABLE	V6, 3.0 L	1992	-	1988

**38126**

Acero Lisa/Posterior (82 mm x 17 mm x 30.5 mm)



CADILLAC	REGAL	V6, 3.8 L	1995	-	1995
CHEVROLET	REGAL	V6, 3.8 L	1994	-	1995
PONTIAC	TRANS SPORT	V6, 3.8 L	1995	-	1995
OLDSMOBILE	SILHOUETTE	V6, 3.8 L	1994	-	1995
PONTIAC	BONNEVILLE	V6, 3.8 L	1994	-	1994
OLDSMOBILE	SILHOUETTE	V6, 3.1 L	1994	-	1994

**38127**

Termoplástico V-Ranurada 6 costillas (76 mm x 17 mm x 25 mm)



FORD	THUNDERBIRD	V6, 3.8 L	1994	-	1994
FORD	MUSTANG	V6, 3.8 L	1996	-	2003
MERCURY	COUGAR XR7	V6, 3.8 L	1993	-	1994

**38130**

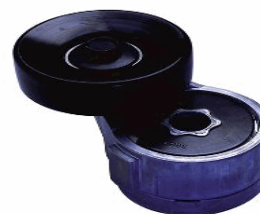

CHEVROLET	BLAZER COMPACT	V6, 2.8 L	1989	-	1989
-----------	----------------	-----------	------	---	------

**38131**

Termoplástico Lisa/Posterior (90 mm x 17 mm x 36 mm)



FORD	E SERIES VAN	6 CIL. 4.9 L	1995	-	1996
FORD	F-150	V6, 4.9 L	1995	-	1996
FORD	F SERIES PICKUP	V6, 4.9 L	1995	-	1996

**38128**



BUICK	CENTURY	V6, 3.3 L	1993	-	1992
BUICK	SKYHAWK	V6, 3.3 L	1993	-	1992
OLDSMOBILE	ACHIEVA	V6, 3.3 L	1993	-	1992
OLDSMOBILE	CUTLASS CIERA	V6, 3.3 L	1993	-	1992
PONTIAC	GRAND AM	V6, 3.3 L	1993	-	1992
OLDSMOBILE	CUTLASS CRUISE!	V6, 3.3 L	1993	-	1992

**38132**

Acero Lisa/Posterior (76 mm x 17 mm x 30.5 mm)



FORD	CROWN VICTORIA	V8, 4.6 L	1996	-	1999
LINCOLN	MARK VIII	V8, 4.6 L	1997	-	1998
FORD	THUNDERBIRD	V8, 4.6 L	1994	-	1996
FORD	THUNDERBIRD	V8, 4.6 L	1997	-	1997
FORD	MUSTANG	V8, 4.6 L	1996	-	1999
MERCURY	GRAND MARQUIS	V8, 4.6 L	1993	-	1999
LINCOLN	MARK VIII	V8, 4.6 L	1994	-	1996
LINCOLN	TOWN CAR	V8, 4.6 L	1993	-	1999

**38129**

Acero Lisa/Posterior (90 mm x 17 mm x 30.5 mm)



FORD	ESCORT	4 CIL. 1.9 L	1994	-	1996
------	--------	--------------	------	---	------

**38133**

Termoplástico Lisa/Posterior (76 mm x 17 mm x 34 mm)



FORD	SUPER DUTY PICK	V8, 5.4 L	2002	-	2002
FORD	F SERIES PICKUP	V10, 6.8 L	1999	-	2000
FORD	EXPEDITION	V8, 4.6 L	1997	-	2001
FORD	E SERIES VAN	V10, 6.8 L	1997	-	1998
FORD	F-350 SUPER DUTY	V8, 5.4 L	1999	-	2006
FORD	EXPEDITION	V8, 4.6 L	2002	-	2002
FORD	SUPER DUTY PICK	V10, 6.8 L	1999	-	2000
FORD	EXCURSION	V8, 5.4 L	2000	-	2001
FORD	SUPER DUTY PICK	V8, 5.4 L	1999	-	2001
FORD	EXPEDITION	V8, 5.4 L	2002	-	2002
FORD	SUPER DUTY VAN	V8, 5.4 L	1999	-	2001
FORD	F-450 SUPER DUTY	V10, 6.8 L	1999	-	2006
FORD	E SERIES VAN	V8, 4.6 L	1999	-	2001
FORD	EXCURSION	V10, 6.8 L	2002	-	2003
FORD	SUPER DUTY PICK	V10, 6.8 L	2002	-	2002
FORD	E SERIES VAN	V8, 5.4 L	1997	-	2002
FORD	F-250	V8, 4.6 L	1998	-	2001
FORD	F SERIES PICKUP	V8, 4.6 L	1998	-	2001
FORD	EXCURSION	V10, 6.8 L	2000	-	2001
FORD	SUPER DUTY VAN	V10, 6.8 L	1999	-	2001
FORD	LOBO	V8, 5.4 L	2002	-	2002
FORD	F SERIES PICKUP	V8, 5.4 L	1999	-	2002
FORD	EXPEDITION	V8, 5.4 L	1997	-	2001
LINCOLN	NAVIGATOR	V8, 5.4 L	1998	-	2001
LINCOLN	NAVIGATOR	V8, 5.4 L	2002	-	2002

**38134**

Acero Lisa/Posterior (100 mm x 17 mm x 30.5 mm)

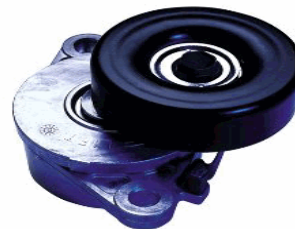

FORD	AEROSTAR	V6, 4.0 L	1993	-	1995
------	----------	-----------	------	---	------

**38135**



CHEVROLET	ASTRO	V6, 4.3 L	1989	-	1989
-----------	-------	-----------	------	---	------

**38136**

Acero Lisa/Posterior (76 mm x 17 mm x 30.5 mm)



CHEVROLET	SILVERADO	V8, 6.6 L	2001	-	2001
-----------	-----------	-----------	------	---	------

**38137**

Termoplástico V-Ranurada 6 costillas (70 mm x 17 mm x 25 mm)



FORD	EXPLORER	V6, 4.0 L	2002	-	2010
FORD	RANGER	V6, 4.0 L	2001	-	2001
FORD	EXPLORER	V6, 4.0 L	2000	-	2004
FORD	EXPLORER	V6, 4.0 L	2005	-	2007
FORD	EXPLORER SPOR1	V6, 4.0 L	2007	-	2010
FORD	EXPLORER SPOR1	V6, 4.0 L	2003	-	2005



FORD	EXPLORER SPORT	V6, 4.0 L	2001	-	2006
MERCURY	MOUNTAINEER	V6, 4.0 L	2005	-	2003

**38141**



FORD	MUSTANG	4 CIL. 2.3 L	1993	-	1987
FORD	THUNDERBIRD	4 CIL. 2.3 L	1988	-	1987

**38138**

Termoplástico Lisa/Posterior (90 mm x 17 mm x 25.5 mm)



**38142**



FORD	SUPER DUTY VAN	V6, 4.2 L	2001	-	2001
FORD	F-150	V6, 4.2 L	1998	-	2007
FORD	F-150	V6, 4.2 L	2008	-	2008
FORD	F SERIES PICKUP	V6, 4.2 L	1998	-	2001
FORD	F SERIES PICKUP	V6, 4.2 L	2002	-	2002
FORD	E SERIES VAN	V6, 4.2 L	1997	-	2003

FORD	THUNDERBIRD	4 CIL. 2.3 L	1988	-	1987
FORD	MUSTANG	4 CIL. 2.3 L	1993	-	1987

**38139**

Termoplástico V-Ranurada 6 costillas (76 mm x 17 mm x 25 mm)

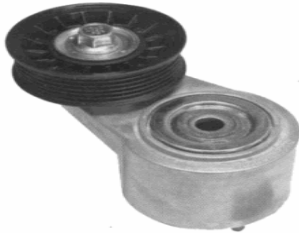

**38143**

Termoplástico Lisa/Posterior (90 mm x 17 mm x 36 mm)



FORD	WINDSTAR	V6, 3.8 L	1995	-	1998
FORD	TAURUS	V6, 3.8 L	1993	-	1993
MERCURY	SABLE / TAURUS	V6, 3.8 L	1993	-	1993
MERCURY	SABLE / TAURUS	V6, 3.8 L	1994	-	1995

CHEVROLET	C & K SERIES PICKUP	V8, 7.4 L	1993	-	1993
CHEVROLET	SUBURBAN	V8, 7.4 L	1993	-	1993

**38140**

Acero Lisa/Posterior (90 mm x 17 mm x 30.5 mm)



**38144**



FORD	E SERIES VAN	V8, 7.5 L	1996	-	1996
FORD	F-450 SUPER DUTY	V8, 7.5 L	1997	-	1997
FORD	F SERIES PICKUP	V8, 7.5 L	1997	-	1997

CHEVROLET	ASTRO	4 CIL. 2.5 L	1990	-	1990
-----------	-------	--------------	------	---	------

**38145**

Acero Lisa/Posterior (90 mm x 17 mm x 30.5 mm)

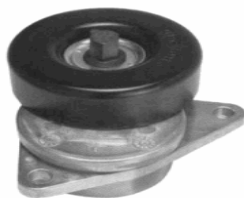

CHEVROLET	CAMARO	V6, 3.4 L	1995 - 1995
CHEVROLET	CAMARO Z28	V8, 5.7 L	1996 - 1997
PONTIAC	FIREBIRD TRANS /	V8, 5.7 L	1997 - 1997

**38146**

Acero Lisa/Posterior (82 mm x 17 mm x 27 mm)



CHEVROLET	CAVALIER	4 CIL. 2.4 L	1996 - 1998
CHEVROLET	CAVALIER	4 CIL. 2.3 L	1995 - 1995
CHEVROLET	MALIBU	4 CIL. 2.4 L	1997 - 1998
PONTIAC	SUNFIRE	4 CIL. 2.4 L	1997 - 1998
PONTIAC	SUNFIRE	4 CIL. 2.4 L	1996 - 1996
PONTIAC	SUNFIRE	4 CIL. 2.3 L	1995 - 1995
PONTIAC	GRAND AM	4 CIL. 2.4 L	1999 - 1999

**38147**



VOLKSWAGEN	GTI	4 CIL. 2.0 L	1999 - 2000
VOLKSWAGEN	JETTA	4 CIL. 2.0 L	1994 - 1994
VOLKSWAGEN	JETTA	4 CIL. 2.0 L	1995 - 2000
VOLKSWAGEN	CABRIO	4 CIL. 2.0 L	1995 - 2002
VOLKSWAGEN	PASSAT	4 CIL. 2.0 L	1993 - 1996
VOLKSWAGEN	GOLF	4 CIL. 2.0 L	1994 - 1994

VOLKSWAGEN	GOLF	4 CIL. 2.0 L	1995 - 2000
------------	------	--------------	-------------

**38148**

Termoplástico Lisa/Posterior (70 mm x 17 mm x 25 mm)



AUDI	TT	4 CIL. 1.8 L	2002 - 2002
AUDI	TT	4 CIL. 1.8 L	2001 - 2005
AUDI	TT	4 CIL. 1.8 L	2006 - 2006
AUDI	TT	4 CIL. 1.8 L	2000 - 2004
SEAT	ALHAMBRA	4 CIL. 1.8 L	2003 - 2007
VOLKSWAGEN	JETTA	4 CIL. 1.9 L DIESEL	2004 - 2005
VOLKSWAGEN	BEETLE	4 CIL. 2.0 L	2003 - 2006
VOLKSWAGEN	GOLF	4 CIL. 1.8 L	2000 - 2005
VOLKSWAGEN	GOLF	4 CIL. 2.0 L	2001 - 2006
VOLKSWAGEN	GOLF	4 CIL. 2.0 L	2004 - 2004
SEAT	CORDOBA	4 CIL. 2.0 L	2003 - 2007
VOLKSWAGEN	JETTA	4 CIL. 1.8 L	2000 - 2005
VOLKSWAGEN	BEETLE	4 CIL. 1.8 L	1999 - 2003
VOLKSWAGEN	GOLF	4 CIL. 2.0 L	1999 - 2005
VOLKSWAGEN	GOLF	4 CIL. 1.8 L	2003 - 2006
VOLKSWAGEN	BEETLE	4 CIL. 2.0 L	2005 - 2008
VOLKSWAGEN	JETTA	4 CIL. 2.0 L	2000 - 2010
VOLKSWAGEN	JETTA	4 CIL. 1.8 L	2006 - 2006
VOLKSWAGEN	BEETLE	4 CIL. 2.0 L	1998 - 2002
SEAT	TOLEDO	4 CIL. 1.8 L	2003 - 2005
VOLKSWAGEN	PASSAT	4 CIL. 2.0 L	2006 - 2006
VOLKSWAGEN	BEETLE	4 CIL. 1.8 L	2004 - 2004
VOLKSWAGEN	BEETLE	4 CIL. 1.8 L	2005 - 2005
VOLKSWAGEN	JETTA	4 CIL. 2.0 L	1999 - 2006
SEAT	LEON	4 CIL. 1.8 L	2003 - 2005
VOLKSWAGEN	SHARAN	4 CIL. 1.8 L	2003 - 2007
SEAT	IBIZA	4 CIL. 2.0 L	2003 - 2009

**38149**



VOLKSWAGEN	PASSAT	4 CIL. 1.8 L	2001 - 2003
VOLKSWAGEN	PASSAT	4 CIL. 1.8 L	1999 - 2005

**38152**

Termoplástico Lisa/Posterior (76 mm x 17 mm x 25 mm)



HYUNDAI	SANTA FE	V6, 2.7 L	2006 - 2001
HYUNDAI	TIBURON	V6, 2.7 L	2006 - 2003
HYUNDAI	TUCSON	V6, 2.7 L	2006 - 2005
KIA	SPORTAGE	V6, 2.7 L	2007 - 2005
KIA	MAGENTIS	V6, 2.7 L (Canada)	2006 - 2002
HYUNDAI	SONATA	V6, 2.7 L	2005 - 2002
KIA	MAGENTIS	V6, 2.5 L (Canada)	2001 - 2001
HYUNDAI	SONATA	V6, 2.5 L	2001 - 1999
KIA	OPTIMA	V6, 2.5 L	2001 - 2001
KIA	OPTIMA	V6, 2.7 L	2006 - 2002

CHEVROLET	REGAL	V6, 3.8 L	1996 - 1996
CHEVROLET	LUMINA	V6, 3.8 L	1998 - 1998
CADILLAC	REGAL	V6, 3.8 L	1996 - 1996
OLDSMOBILE	EIGHTY EIGHT	V6, 3.8 L	1998 - 1998
PONTIAC	BONNEVILLE	V6, 3.8 L	1995 - 1998
PONTIAC	GRAND PRIX	V6, 3.8 L	1997 - 1998

**38153**

Acero Lisa/Posterior (76 mm x 17 mm x 30,5 mm)



**38150**

Termoplástico V-Ranurada 6 costillas (70 mm x 17 mm x 25 mm)



FORD	WINDSTAR	V6, 3.8 L	1999 - 2001
FORD	FREESTAR	V6, 3.9 L	2004 - 2005
FORD	FREESTAR	V6, 4.2 L	2004 - 2005
FORD	WINDSTAR	V6, 3.8 L	2002 - 2003

CADILLAC	ELDORADO	V8, 4.6 L	1998 - 1998
CADILLAC	DTS	V8, 4.6 L	2006 - 2007
CADILLAC	DEVILLE	V8, 4.6 L	2005 - 2005
CADILLAC	SEVILLE	V8, 4.6 L	1998 - 2001
CADILLAC	ELDORADO	V8, 4.6 L	1994 - 1999
CADILLAC	ELDORADO	V8, 4.6 L	2000 - 2002
CADILLAC	SEVILLE	V8, 4.6 L	2002 - 2004
CADILLAC	DEVILLE	V8, 4.6 L	1998 - 2001
CADILLAC	DEVILLE	V8, 4.6 L	2002 - 2004

**38151**

Acero Lisa/Posterior (76 mm x 17 mm x 24 mm)



AUDI	A4	4 CIL. 1.8 L	2000 - 2001
AUDI	A4	4 CIL. 1.8 L	1998 - 2002

**38154**



ISUZU	RODEO	4 CIL. 2.2 L	2003 - 1998
CHEVROLET	OPTRA	4 CIL. 2.0 L (Canada)	2007 - 2004
DAEWOO	LEGANZA	4 CIL. 2.2 L	2002 - 1999
ISUZU	AMIGO	4 CIL. 2.2 L	2000 - 1998
DAEWOO	NUBIRA	4 CIL. 2.0 L	2002 - 1999
SUZUKI	FORENZA	4 CIL. 2.0 L	2007 - 2004
SUZUKI	RENO	4 CIL. 2.0 L	2007 - 2005

**38157**

Acero Lisa/Posterior (76.2 mm x 10.3 mm x 33 mm)



DODGE	RAM SERIES PICKU	6 CIL. 5.9 L	2002 - 2002
DODGE	RAM SERIES PICKU	6 CIL. 5.9 L Diesel	1999 - 2002

**38158**

Termoplástico V-Ranurada 6 costillas (76 mm x 17 mm x 25 mm)



CHEVROLET	SILVERADO	V8, 6.0 L	2003 - 2007
CADILLAC	ESCALADE	V8, 6.2 L	2008 - 2008
CHEVROLET	TAHOE	V8, 5.3 L	2006 - 2007
CHEVROLET	AVALANCHE	V8, 5.3 L	2006 - 2006
CADILLAC	ESCALADE	V8, 6.0 L	2002 - 2003
CHEVROLET	SILVERADO	V8, 6.0 L	2000 - 2002
CADILLAC	ESCALADE	V8, 6.0 L	2006 - 2006
CHEVROLET	SUBURBAN	V8, 5.3 L	2000 - 2007
CHEVROLET	SILVERADO PICKU	V8, 5.3 L	1999 - 2005
CHEVROLET	SUBURBAN	V8, 5.3 L	2002 - 2008
CADILLAC	ESCALADE	V8, 6.0 L	2004 - 2005
CHEVROLET	SILVERADO PICKU	V8, 4.8 L	2004 - 2004
CHEVROLET	SUBURBAN	V8, 6.0 L	2000 - 2007
CHEVROLET	TRAILBLAZER	V8, 5.3 L	2006 - 2006
CHEVROLET	AVALANCHE	V8, 5.3 L	2007 - 2007
CHEVROLET	SILVERADO PICKU	V8, 6.0 L	2000 - 2003
CHEVROLET	TRAILBLAZER	V8, 5.3 L	2003 - 2007
CHEVROLET	TAHOE	V8, 4.8 L	2006 - 2007
CHEVROLET	TRAILBLAZER	V8, 5.3 L	2005 - 2005
CHEVROLET	AVALANCHE	V8, 5.3 L	2002 - 2008
CHEVROLET	TRAILBLAZER	V8, 6.0 L	2006 - 2006

**38155**

Acero Lisa/Posterior (76 mm x 17 mm x 31 mm) - c/Tornillo



FORD	RANGER	4 CIL. 2.3 L	1995 - 2003
FORD	RANGER	4 CIL. 2.3 L	2008 - 2010
FORD	RANGER	4 CIL. 2.3 L	2001 - 2007
FORD	RANGER	4 CIL. 2.5 L	1998 - 2001

**38156**

Acero Lisa/Posterior (90 mm x 17 mm x 30 mm)

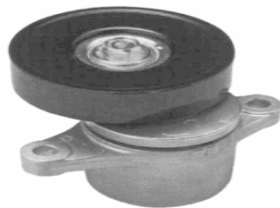

CHEVROLET	TRACKER	4 CIL. 2.0 L	1999 - 2001
CHEVROLET	TRACKER	4 CIL. 2.0 L	2002 - 2003
SUZUKI	AERIO	4 CIL. 2.3 L	2005 - 2006
SUZUKI	SX4	4 CIL. 2.0 L	2007 - 2010

CHEVROLET	TAHOE	V8, 5.3 L	2008	-	2008
CHEVROLET	SILVERADO PICKU	V8, 4.8 L	2001	-	2007
CHEVROLET	SUBURBAN	V8, 6.0 L	2002	-	2008
CADILLAC	ESCALADE	V8, 6.2 L	2007	-	2007
CHEVROLET	SILVERADO PICKU	V8, 5.3 L	2004	-	2004
CADILLAC	ESCALADE	V8, 5.3 L	2004	-	2004
CHEVROLET	SILVERADO	V8, 5.3 L	2003	-	2007
CHEVROLET	SILVERADO	V8, 5.3 L	2000	-	2002
GMC	YUKON	V8, 6.2 L	2007	-	2008
CHEVROLET	EXPRESS	V8, 5.3 L	2007	-	2007
HUMMER	H2	V8, 6.0 L	2005	-	2005
CHEVROLET	SILVERADO	V8, 4.8 L	2003	-	2007
CHEVROLET	EXPRESS	V8, 6.0 L	2005	-	2006
HUMMER	H2	V8, 6.0 L	2006	-	2007
CHEVROLET	EXPRESS	V8, 5.3 L	2006	-	2006
CHEVROLET	EXPRESS	V8, 6.0 L	2007	-	2007
GMC	SAVANA	V8, 5.3 L	2007	-	2003
CHEVROLET	SILVERADO	V8, 4.8 L	2001	-	2002
CHEVROLET	EXPRESS	V8, 6.0 L	2003	-	2008
CHEVROLET	SILVERADO	V8, 5.3 L	2008	-	2008
GMC	SAVANA	V8, 6.0 L	2007	-	2003
HUMMER	H2	V8, 6.2 L	2008	-	2008
CHEVROLET	SILVERADO	V8, 4.8 L	2008	-	2008
GMC	SIERRA	V8, 6.2 L	2007	-	2008
CADILLAC	ESCALADE	V8, 5.3 L	2002	-	2005
GMC	ENVOY	V8, 5.3 L	2007	-	2003
CHEVROLET	EXPRESS	V8, 5.3 L	2003	-	2008
GMC	YUKON	V8, 5.3 L	2007	-	2008
GMC	SAVANA	V8, 4.8 L	2007	-	2003

CHEVROLET	AVALANCHE	V8, 5.3 L	2006	-	2006
CADILLAC	ESCALADE	V8, 5.3 L	2004	-	2004
CHEVROLET	SILVERADO	V8, 5.3 L	2000	-	2002
HUMMER	H2	V8, 6.2 L	2008	-	2008
CHEVROLET	TAHOE	V8, 4.8 L	2006	-	2007
CHEVROLET	EXPRESS	V8, 5.3 L	2005	-	2006
GMC	SAVANA	V8, 4.8 L	2007	-	2003
HUMMER	H2	V8, 6.0 L	2005	-	2005
CHEVROLET	SILVERADO	V8, 6.0 L	2003	-	2007
CHEVROLET	TAHOE	V8, 5.3 L	2006	-	2007
GMC	YUKON	V8, 6.2 L	2007	-	2008
CHEVROLET	SILVERADO PICKU	V8, 4.8 L	2004	-	2004
CHEVROLET	SILVERADO PICKU	V8, 4.8 L	1999	-	2003
CHEVROLET	SILVERADO PICKU	V8, 5.3 L	2004	-	2004
GMC	SAVANA	V8, 6.0 L	2007	-	2003
CHEVROLET	SILVERADO PICKU	V8, 5.3 L	2002	-	1999
CHEVROLET	SILVERADO PICKU	V8, 6.0 L	2004	-	1999
GMC	SIERRA	V8, 6.2 L	2007	-	2008
GMC	YUKON	V8, 5.3 L	2007	-	2008
CHEVROLET	SUBURBAN	V8, 6.0 L	2000	-	2007
CHEVROLET	SUBURBAN	V8, 5.3 L	2000	-	2007
CHEVROLET	EXPRESS	V8, 5.3 L	2004	-	2007
GMC	SAVANA	V8, 5.3 L	2007	-	2003
CHEVROLET	EXPRESS	V8, 6.0 L	2004	-	2007
CHEVROLET	EXPRESS	V8, 6.0 L	2005	-	2006
CHEVROLET	SUBURBAN	V8, 6.0 L	2002	-	2008
CHEVROLET	EXPRESS	V8, 5.3 L	2003	-	2008
CHEVROLET	EXPRESS	V8, 6.0 L	2003	-	2008
CHEVROLET	AVALANCHE	V8, 5.3 L	2004	-	2007
CHEVROLET	AVALANCHE	V8, 5.3 L	2002	-	2008
CHEVROLET	SILVERADO	V8, 6.0 L	2000	-	2002
CHEVROLET	SUBURBAN	V8, 5.3 L	2002	-	2008
CHEVROLET	SILVERADO	V8, 4.8 L	2001	-	2002
CHEVROLET	TRAILBLAZER	V8, 6.0 L	2006	-	2006
CADILLAC	ESCALADE	V8, 6.2 L	2007	-	2007
CHEVROLET	TRAILBLAZER	V8, 5.3 L	2003	-	2007
CHEVROLET	SILVERADO	V8, 5.3 L	2003	-	2007

**38159**

Acero Lisa/Posterior (60 mm x 12 mm x 21 mm)



CHEVROLET	TAHOE	V8, 5.3 L	2008	-	2008
-----------	-------	-----------	------	---	------

GMC	ENVOY	V8, 5.3 L	2007	-	2003
CHEVROLET	TRAILBLAZER	V8, 5.3 L	2006	-	2006
CHEVROLET	TRAILBLAZER	V8, 5.3 L	2005	-	2005
CHEVROLET	SILVERADO	V8, 4.8 L	2008	-	2008
CADILLAC	ESCALADE	V8, 6.2 L	2008	-	2008
CHEVROLET	SILVERADO	V8, 4.8 L	2003	-	2007
CADILLAC	ESCALADE	V8, 6.0 L	2002	-	2003
HUMMER	H2	V8, 6.0 L	2006	-	2007
CHEVROLET	SILVERADO	V8, 5.3 L	2008	-	2008
CADILLAC	ESCALADE	V8, 5.3 L	2002	-	2005
CADILLAC	ESCALADE	V8, 6.0 L	2006	-	2006
CADILLAC	ESCALADE	V8, 6.0 L	2004	-	2005

**38160**

Acero V-Ranurada 6 costillas (98 mm x 17 mm x 27 mm)



FORD	CONTOUR	4 CIL. 2.0 L	1995	-	1995
FORD	CONTOUR	4 CIL. 2.0 L	1997	-	1997
MERCURY	MYSTIQUE	4 CIL. 2.0 L	1995	-	1997

**38161**

Acero Lisa/Posterior (100 mm x 17 mm x 30.5 mm)



FORD	EXPLORER	V8, 5.0 L	1998	-	2001
MERCURY	MOUNTAINEER	V8, 5.0 L	1997	-	2000

**38162**

Acero Lisa/Posterior (76 mm x 17 mm x 30.5 mm)



FORD	ESCORT	4 CIL. 2.0 L	2001	-	2001
FORD	ZX2	4 CIL. 2.0 L	2001	-	2003
FORD	ESCORT	4 CIL. 2.0 L	1998	-	2002

**38163**

Termoplástico Lisa/Posterior (70 mm x 17 mm x 25 mm)



JEEP	WRANGLER	6 CIL. 4.0 L	2005	-	2005
JEEP	WRANGLER	6 CIL. 4.0 L	2001	-	2003
JEEP	WRANGLER	6 CIL. 4.0 L	2000	-	2006
JEEP	GRAND CHEROKE	6 CIL. 4.0 L	1999	-	2004

**38164**

Termoplástico Lisa/Posterior (76 mm x 17 mm x 25 mm)



CHEVROLET	CAVALIER	4 CIL. 2.2 L	1998	-	2002
PONTIAC	SUNFIRE	4 CIL. 2.2 L	1998	-	2002

**38165**

Termoplástico Lisa/Posterior (76 mm x 17 mm x 25 mm)

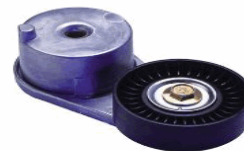

CHEVROLET	S SERIES PICKUP	4 CIL. 2.2 L	2003	-	2003
CHEVROLET	S-10	4 CIL. 2.2 L	2002	-	2002
CHEVROLET	S-10	4 CIL. 2.2 L	1998	-	2001
GMC	SONOMA	4 CIL. 2.2 L	2003	-	2000

**38166**



OLDSMOBILE	AURORA	V6, 3.5 L	2002	-	2001
OLDSMOBILE	INTRIGUE	V6, 3.5 L	2002	-	1999

**38167**

Acero Lisa/Posterior (90 mm x 17 mm x 29.5 mm); Termoplástico V-Ranurada 6 costillas (76 mm x 17 mm x 28 mm)



JEEP	GRAND CHEROKE	V6, 3.7 L	2006	-	2007
JEEP	GRAND CHEROKE	V8, 4.7 L	1999	-	2006
DODGE	RAM SERIES PICK	V6, 3.7 L	2002	-	2003
JEEP	GRAND CHEROKE	V8, 4.7 L	2007	-	2007
JEEP	GRAND CHEROKE	V6, 3.7 L	2005	-	2005
DODGE	NITRO	V6, 3.7 L	2007	-	2008
DODGE	RAM 1500	V6, 3.7 L	2004	-	2005
DODGE	DURANGO	V8, 4.7 L	2006	-	2006
DODGE	RAM 2500	V8, 4.7L	2002	-	2003
JEEP	LIBERTY	V6, 3.7 L	2005	-	2005
JEEP	LIBERTY	V6, 3.7 L	2006	-	2007
DODGE	DAKOTA	V6, 3.7 L	2007	-	2008
DODGE	DURANGO	V6, 3.7 L	2005	-	2005
DODGE	DURANGO	V8, 4.7 L	2000	-	2005
DODGE	DURANGO	V6, 3.7 L	2004	-	2004
JEEP	LIBERTY	V6, 3.7 L	2002	-	2004

**38168**

Termoplástico Lisa/Posterior (76 mm x 17 mm x 22 mm)



FORD	TOPAZ	4 CIL. 2.3 L	1994	-	1994
------	-------	--------------	------	---	------

**38169**

Acero Lisa/Posterior (90 mm x 17 mm x 30.5 mm)



HONDA	ACCORD	V6, 3.0 L	1998	-	2002
ACURA	CL	V6, 3.0 L	1999	-	1999
HONDA	ODYSSEY	V6, 3.5 L	1999	-	2000

**38170**



LEXUS	GS300	6 CIL. 3.0 L	2005	-	1993
LEXUS	IS300	6 CIL. 3.0 L	2002	-	2001
LEXUS	SC300	6 CIL. 3.0 L	2000	-	1992
TOYOTA	SUPRA	6 CIL. 3.0 L	1998	-	1993

**38171**

Acero Lisa/Posterior (90 mm x 17 mm x 30.5 mm)

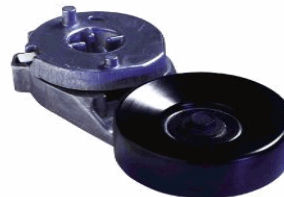

FORD	ESCORT	4 CIL. 2.0 L	1997	-	2002
------	--------	--------------	------	---	------

**38172**

Acero V-Ranurada 6 costillas (70 mm x 17 mm x 24 mm)



CHEVROLET	EXPRESS	V8, 6.6 L	2007 - 2007
GMC	SAVANA	V8, 6.6 L	2007 - 2006
HUMMER	H1	V8, 6.6 L	2006 - 2007

**38173**

Acero Lisa/Posterior (102 mm x 17 mm x 26 mm)



TOYOTA	LAND CRUISER	V8, 4.7 L	2003 - 2007
TOYOTA	LAND CRUISER	V8, 4.7 L	2006 - 2006
TOYOTA	TUNDRA	V8, 4.7 L	2007 - 2008
TOYOTA	4 RUNNER	V8, 4.7 L	2006 - 2007
TOYOTA	4 RUNNER	V8, 4.7 L	2003 - 2005
TOYOTA	SEQUOIA	V8, 4.7 L	2007 - 2008

**38174**

Termoplástico Lisa/Posterior (90 mm x 17 mm x 26 mm)



CHRYSLER	CROSSFIRE	V6, 3.2 L	2004 - 2005
MERCEDES-BE	SL500	V8, 5.0 L	2001 - 2005
MERCEDES-BE	SL55	V8, 5.5 L	2003 - 2006
MERCEDES-BE	ML320	V6, 3.2 L	2001 - 2003
MERCEDES-BE	SLK320	V6, 3.2 L	2001 - 2004
MERCEDES-BE	CL500	V8, 5.0 L	2002 - 2005
MERCEDES-BE	C240	V6, 2.6 L	2001 - 2005

MERCEDES-BE	S55	V8, 5.5 L	2001 - 2005
MERCEDES-BE	C320	V6, 3.2 L	2002 - 2005
MERCEDES-BE	C320	V6, 3.2 L	2001 - 2004
MERCEDES-BE	CL500	V8, 5.0 L	2000 - 2001
MERCEDES-BE	C280	V6, 2.8 L	1998 - 2000
MERCEDES-BE	CL55	V8, 5.5 L	2001 - 2006
MERCEDES-BE	CLK320	V6, 3.2 L	2001 - 2005
MERCEDES-BE	CLK430	V8, 4.3 L	2000 - 2003
MERCEDES-BE	S500	V8, 5.0 L	2001 - 2005
MERCEDES-BE	CLK500	V8, 5.0 L	2003 - 2005
MERCEDES-BE	CLK55	V8, 5.5 L	2001 - 2006
MERCEDES-BE	E320	V6, 3.2 L	2001 - 2006
MERCEDES-BE	E430	V8, 4.3 L	2001 - 2001
MERCEDES-BE	E55	V8, 5.5 L	2001 - 2002
MERCEDES-BE	S430	V8, 4.3 L	2001 - 2005
MERCEDES-BE	CLK430	V8, 4.3 L	2002 - 2002

**38175**

Termoplástico V-Ranurada 7 costillas (62 mm x 17 mm x 29 mm)



VOLKSWAGEN	GTI	V6, 2.8 L	1999 - 2001
VOLKSWAGEN	PASSAT	V6, 2.8 L	1995 - 1997
VOLKSWAGEN	GOLF	V6, 2.8 L	1995 - 2000
VOLKSWAGEN	JETTA	V6, 2.8 L	1999 - 2004
VOLKSWAGEN	JETTA	V6, 2.8 L	1995 - 2002

**38176**

Termoplástico Lisa/Posterior (70 mm x 17 mm x 19 mm)



CHRYSLER	PT CRUISER	4 CIL. 2.4 L	2002 - 2005
CHRYSLER	PT CRUISER	4 CIL. 2.4 L	2003 - 2010



DODGE	NEON	4 CIL. 2.4 L	2004	-	2004
CHRYSLER	PT CRUISER	4 CIL. 2.4 L	2000	-	2007

**38177**

Acero Lisa/Posterior (82 mm x 17 mm x 27 mm)



CHEVROLET	VECTRA	4 CIL. 2.2 L	2003	-	2005
CHEVROLET	CAPTIVA	4 CIL. 2.4 L	2008	-	2008
CHEVROLET	HHR	4 CIL. 2.4 L	2006	-	2010
CHEVROLET	CAVALIER	4 CIL. 2.2 L	2004	-	2005
CHEVROLET	VECTRA	V6, 2.8 L	2007	-	2008
CHEVROLET	MALIBU	4 CIL. 2.2 L	2005	-	2006
CHEVROLET	MALIBU	4 CIL. 2.4 L	2008	-	2010
CHEVROLET	MALIBU	4 CIL. 2.2 L	2004	-	2007
CHEVROLET	CAVALIER	4 CIL. 2.2 L	2002	-	2003
SAAB	9 - 3	4 CIL. 2.0 L	2003	-	2003
SAAB	9 - 3	4 CIL. 2.0 L	2003	-	2003
PONTIAC	G5	4 CIL. 2.4 L	2007	-	2008
PONTIAC	G5	4 CIL. 2.2 L	2007	-	2008
PONTIAC	SOLSTICE	4 CIL. 2.4 L	2006	-	2008
PONTIAC	G4	4 CIL. 2.4 L	2006	-	2006
PONTIAC	G4	4 CIL. 2.2 L	2006	-	2006
PONTIAC	GRAND AM	4 CIL. 2.2 L	2003	-	2003
PONTIAC	SUNFIRE	4 CIL. 2.2 L	2004	-	2005
PONTIAC	SUNFIRE	4 CIL. 2.2 L	2003	-	2003
PONTIAC	GRAND AM	4 CIL. 2.2 L	2002	-	2002
PONTIAC	SUNFIRE	4 CIL. 2.2 L	2002	-	2002
SATURN	ION	4 CIL. 2.4 L	2006	-	2007
SATURN	SKY	4 CIL. 2.4 L	2007	-	2007
SATURN	ION	4 CIL. 2.2 L	2004	-	2007

**38178**

Termoplástico Lisa/Posterior (70 mm x 17 mm x 25 mm)



CHEVROLET	COLORADO	4 CIL. 2.8 L	2006	-	2006
CHEVROLET	COLORADO	5 CIL. 3.5 L	2006	-	2006
GMC	ENVOY	6 CIL. 4.2 L	2007	-	2002
GMC	CANYON	5 CIL. 3.7 L	2007	-	2010
CHEVROLET	COLORADO	4 CIL. 2.9 L	2007	-	2007
CHEVROLET	COLORADO	4 CIL. 2.9 L	2008	-	2010
CHEVROLET	COLORADO	5 CIL. 3.5 L	2004	-	2005
CHEVROLET	TRAILBLAZER	6 CIL. 4.2 L	2006	-	2006
CHEVROLET	TRAILBLAZER	6 CIL. 4.2 L	2002	-	2007
CHEVROLET	COLORADO	5 CIL. 3.7 L	2007	-	2007
CHEVROLET	TRAILBLAZER	6 CIL. 4.2 L	2004	-	2005
HUMMER	H3	5 CIL. 3.7 L	2008	-	2010
HUMMER	H3	5 CIL. 3.5 L	2006	-	2007
CHEVROLET	COLORADO	5 CIL. 3.7 L	2008	-	2010
GMC	CANYON	4 CIL. 2.9 L	2007	-	2007
CHEVROLET	COLORADO	4 CIL. 2.8 L	2005	-	2005

**38179**

Termoplástico V-Ranurada 6 costillas (76 mm x 17 mm x 25 mm)



CADILLAC	CTS	V6, 3.2 L	2003	-	2004
CADILLAC	CATERA	V6, 3.0 L	1998	-	2001
SAAB	9 - 5	V6, 3.0 L	2000	-	2000
SAAB	9 - 5	V6, 3.0 L	2002	-	2002

**38180**

Acero Lisa/Posterior (76 mm x 17 mm x 31 mm)



DODGE	RAM SERIES PICK	V8, 5.9 L	1997	-	2001
DODGE	RAM SERIES PICK	V10, 8.0 L	1999	-	2000

**38181**

Acero Lisa/Posterior (76 mm x 17 mm x 30.5 mm)



FORD	TAURUS	V6, 3.0 L	2000	-	2000
MERCURY	SABLE / TAURUS	V6, 3.0 L	1998	-	2000

**38182**

Acero Lisa/Posterior (76 mm x 17 mm x 30.5 mm)



FORD	MUSTANG	V8, 5.0 L	1994	-	1995
------	---------	-----------	------	---	------

**38183**



CADILLAC	DEVILLE	V8, 4.1 L	1987	-	1985
CADILLAC	FLEETWOOD	V8, 4.5 L	1989	-	1988
CADILLAC	ALLANTE	V8, 4.1 L	1988	-	1987
CADILLAC	ALLANTE	V8, 4.5 L	1989	-	1989

CADILLAC	DEVILLE	V8, 4.5 L	1989	-	1988
CADILLAC	ELDORADO	V8, 4.1 L	1987	-	1986
CADILLAC	ELDORADO	V8, 4.5 L	1989	-	1988
CADILLAC	FLEETWOOD	V8, 4.1 L	1987	-	1985
CADILLAC	SEVILLE	V8, 4.1 L	1987	-	1986
CADILLAC	SEVILLE	V8, 4.5 L	1989	-	1988

**38184**



CADILLAC	DEVILLE	V8, 4.9 L	1995	-	1991
CADILLAC	SEVILLE	V8, 4.9 L	1993	-	1991
CADILLAC	SEVILLE	V8, 4.5 L	1990	-	1990
CADILLAC	FLEETWOOD	V8, 4.9 L	1992	-	1991
CADILLAC	FLEETWOOD	V8, 4.5 L	1990	-	1990
CADILLAC	SIXTY SPECIAL	V8, 4.9 L	1993	-	1993
CADILLAC	ELDORADO	V8, 4.9 L	1993	-	1991
CADILLAC	ELDORADO	V8, 4.5 L	1990	-	1990
CADILLAC	ALLANTE	V8, 4.5 L	1992	-	1990
CADILLAC	DEVILLE	V8, 4.5 L	1990	-	1990

**38185**

Acero Lisa/Posterior (70 mm x 17 mm x 25 mm)



CHRYSLER	TOWN & COUNTRY	V6, 3.8 L	2005	-	2005
CHRYSLER	TOWN & COUNTRY	V6, 3.8 L	2006	-	2007
DODGE	CARAVAN	V6, 3.3 L	2002	-	2006
CHRYSLER	VOYAGER	V6, 3.3 L	2003	-	2007
CHRYSLER	VOYAGER	V6, 3.3 L	2001	-	2002
DODGE	CARAVAN	V6, 3.3 L	2007	-	2007
JEEP	WRANGLER	4 CIL. 2.4 L	2003	-	2006

**38186**

Acero Lisa/Posterior (76 mm x 17 mm x 30.5 mm)



FORD	ESCAPE	V6, 3.0 L	2001 - 2003
FORD	ESCAPE	V6, 3.0 L	2004 - 2004
MERCURY	SABLE / TAURUS	V6, 3.0 L	2003 - 2005

**38189**

Acero Lisa/Posterior (76 mm x 17 mm x 30.5 mm)



FORD	CROWN VICTORIA	V8, 4.6 L	2001 - 2004
FORD	MUSTANG	V8, 4.6 L	2000 - 2004
LINCOLN	TOWN CAR	V8, 4.6 L	2000 - 2006
LINCOLN	TOWN CAR	V8, 4.6 L	2001 - 2001
MERCURY	GRAND MARQUIS	V8, 4.6 L	2005 - 2005
MERCURY	GRAND MARQUIS	V8, 4.6 L	2000 - 2004

**38187**

Acero Lisa/Posterior (90 mm x 17 mm x 30.5 mm)



CHEVROLET	S-10	4 CIL. 2.2 L	1997 - 1997
CHEVROLET	S-10	4 CIL. 2.2 L	1994 - 1996
CHEVROLET	S SERIES PICKUP	4 CIL. 2.2 L	1997 - 1997

**38190**

Termoplástico Lisa/Posterior (70 mm x 17 mm x 25 mm)



VOLVO	S80	6 CIL. 2.9 L	2002 - 2005
VOLVO	C70	5 CIL. 2.4 L	2004 - 2004
VOLVO	S40	4 CIL. 1.9 L	2002 - 2004
VOLVO	S60	5 CIL. 2.5 L	2004 - 2006
VOLVO	S80	5 CIL. 2.5 L	2005 - 2006
VOLVO	C70	5 CIL. 2.3 L	2004 - 2004
VOLVO	XC90	5 CIL. 2.5 L	2003 - 2006

**38188**

Termoplástico V-Ranurada 6 costillas (70 mm x 17 mm x 25 mm)



FORD	ESCAPE	4 CIL. 2.0 L	2001 - 2002
FORD	CONTOUR	4 CIL. 2.0 L	1998 - 2000
FORD	FOCUS	4 CIL. 2.0 L	2000 - 2003
FORD	FOCUS	4 CIL. 2.0 L	2002 - 2002
MERCURY	MYSTIQUE	4 CIL. 2.0 L	1999 - 2000
MERCURY	MYSTIQUE	4 CIL. 2.0 L	1998 - 1998

**38191**

Acero Lisa/Posterior (76 mm x 17 mm x 37 mm); Acero V-Ranurada 8 costillas (76 mm x 17 mm x 38 mm)



FORD	SUPER DUTY PICK	V8, 7.3 L	1999 - 2002
FORD	EXCURSION	V8, 7.3 L	2003 - 2003
FORD	F-450 SUPER DUTY	V8, 7.3 L	2002 - 2003

**38192**

Acero Lisa/Posterior (70 mm x 17 mm x 24 mm) - c/Damper Hidráulico



VOLKSWAGEN	BEETLE	4 CIL. 1.9 L	2003	-	2003
VOLKSWAGEN	JETTA	4 CIL. 1.9 L DIESEL	2000	-	2004

**38195**



CHEVROLET	CAMARO	V8, 5.7 L	2002	-	2002
-----------	--------	-----------	------	---	------

**38193**

Acero Lisa/Posterior (76 mm x 17 mm x 25 mm)



AUDI	S4 QUATTRO	V6, 2.7 L	2001	-	2002
AUDI	S4 QUATTRO	V6, 2.7 L	2000	-	2000
AUDI	A4	V6, 2.8 L	1999	-	2001
AUDI	ALLROAD QUATTR	V6, 2.7 L	2002	-	2006
AUDI	A6	V6, 2.7 L	2000	-	2000
AUDI	ALLROAD QUATTR	V6, 2.7 L	2004	-	2005
AUDI	A6	V6, 2.8 L	1998	-	2001
AUDI	A4	V6, 2.8 L	1998	-	1998
VOLKSWAGEN	PASSAT	V6, 2.8 L	2004	-	2004
VOLKSWAGEN	PASSAT	V6, 2.8 L	1998	-	2005

**38196**

Termoplástico Lisa/Posterior (65 mm x 17 mm x 20 mm)



CHEVROLET	CORVETTE	V8, 5.7 L	2004	-	2004
CHEVROLET	CORVETTE	V8, 5.7 L	1997	-	2003
CHEVROLET	CAMARO	V8, 5.7 L	2002	-	2002

**38197**

Termoplástico V-Ranurada 3 costillas (52 mm x 17 mm x 15 mm)



CADILLAC	DEVILLE	V8, 4.6 L	1998	-	2003
CADILLAC	DEVILLE	V8, 4.6 L	2004	-	2004
CADILLAC	ELDORADO	V8, 4.6 L	1998	-	2002
CADILLAC	DTS	V8, 4.6 L	2006	-	2007
CADILLAC	SEVILLE	V8, 4.6 L	1998	-	2003
CADILLAC	SEVILLE	V8, 4.6 L	2004	-	2004
CADILLAC	DEVILLE	V8, 4.6 L	2005	-	2005

**38194**

Termoplástico V-Ranurada 6 costillas (70 mm x 17 mm x 25 mm)



CHEVROLET	CORVETTE	V8, 5.7 L	1997	-	2003
CHEVROLET	CORVETTE	V8, 5.7 L	2004	-	2004

**38198**

Termoplástico Lisa/Posterior (82 mm x 17 mm x 25 mm)



CHEVROLET	LUMINA	V6, 3.4 L	1993	-	1997
-----------	--------	-----------	------	---	------

**38199**



BUICK	SKYHAWK	4 CIL. 2.0 L	1988	-	1987
PONTIAC	SUNBIRD	4 CIL. 2.0 L	1994	-	1987
OLDSMOBILE	FIRENZA	4 CIL. 2.0 L	1988	-	1987
PONTIAC	LEMANS	4 CIL. 2.0 L	1990	-	1989
PONTIAC	GRAND AM	4 CIL. 2.0 L	1989	-	1987

**38200**

Termoplástico Lisa/Posterior (70 mm x 17 mm x 25 mm)



CHEVROLET	CHEVY PICK-UP	4 CIL. 1.6 L	2002	-	2006
CHEVROLET	CHEVY	4 CIL. 1.6 L	2009	-	2010
CHEVROLET	CHEVY C2	4 CIL. 1.6 L	2004	-	2008
CHEVROLET	CHEVY SWING	4 CIL. 1.6 L	1994	-	2003
CHEVROLET	CHEVY C2 SEDAN	4 CIL. 1.6 L	2004	-	2008
CHEVROLET	CHEVY POP	4 CIL. 1.6 L	1994	-	2003
CHEVROLET	ASTRA	4 CIL. 2.0 L	2007	-	2008
CHEVROLET	MONZA	4 CIL. 1.6 L	1994	-	2004
CHEVROLET	TIGRA	4 CIL. 1.6 L	1999	-	1999
CHEVROLET	CHEVY JOY	4 CIL. 1.6 L	1994	-	2003

CHEVROLET	OPTRA	4 CIL. 2.0 L	2006	-	2010
CHEVROLET	TIGRA	4 CIL. 1.6 L	2000	-	2000

**38201**

Termoplástico Lisa/Posterior (70 mm x 17 mm x 26 mm)



BMW	X5	6 CIL. 3.0 L	2006	-	2006
BMW	Z4	6 CIL. 2.5 L	2003	-	2005
BMW	528i	V6, 2.8 L	1998	-	2000
BMW	330CI	6 CIL. 3.0 L	2001	-	2003
BMW	Z3	6 CIL. 2.8 L	1998	-	1998
BMW	328i	V6, 2.8 L	2000	-	2000
BMW	525i	6 CIL. 2.5 L	2001	-	2005
BMW	318i	V6, 2.8 L	2000	-	2000
BMW	Z4	6 CIL. 3.0 L	2003	-	2005
BMW	M3	6 CIL. 3.2 L	2001	-	2001
BMW	528i	V6, 2.8 L	1999	-	1999
BMW	330XI	6 CIL. 3.0 L	2001	-	2005
BMW	Z4	V6, 2.5 L	2005	-	2006
BMW	530i	6 CIL. 3.0 L	2002	-	2002
BMW	325XI	6 CIL. 2.5 L	2004	-	2005
BMW	Z4	V6, 3.0 L	2004	-	2004
BMW	X3	6 CIL. 3.0 L	2005	-	2006
BMW	Z4	V6, 2.5 L	2004	-	2004
BMW	X5	V6, 3.0 L	2004	-	2004
BMW	X5	6 CIL. 3.0 L	2005	-	2005

**38204**

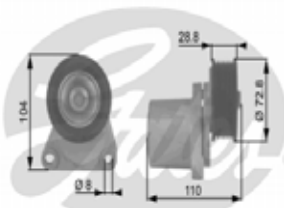

FORD	MONDEO	4 CIL. 2.0 L	2003	-	2006
------	--------	--------------	------	---	------

FORD ECOSPORT 4 CIL. 2.0 L 2003 - 2010

**38207**

Acero Lisa/Posterior (76 mm x 17 mm x 28 mm)



AUDI	A4	4 CIL. 1.8 L	2003 - 2006
AUDI	A4	4 CIL. 2.0 L	2007 - 2007
AUDI	A4	4 CIL. 1.8 L	2004 - 2004

**38217**



BMW	850I	V12, 5.0 L	1992 - 1991
BMW	850CSI	V12, 5.6 L	1995 - 1994
BMW	850CI	V12, 5.4 L	1997 - 1995
BMW	850CI	V12, 5.0 L	1994 - 1993
BMW	750IL	V12, 5.0 L	1993 - 1988

**38211**



MERCEDES-BE	E320	6 CIL. 3.2 L	1995 - 1994
MERCEDES-BE	SL320	6 CIL. 3.2 L	1996 - 1994
MERCEDES-BE	300TE	6 CIL. 3.2 L	1993 - 1993
MERCEDES-BE	300E	6 CIL. 2.8 L	1993 - 1993
MERCEDES-BE	300E	6 CIL. 3.2 L	1993 - 1993
MERCEDES-BE	S320	6 CIL. 3.2 L	1999 - 1994

**38218**



BMW	740IL	V8, 4.4 L	1998 - 2001
BMW	740I	V8, 4.4 L	1998 - 2001
BMW	X5	V8, 4.4 L	2000 - 2000
BMW	540I	V8, 4.4 L	1998 - 2003
BMW	M5	V8, 5.0 L	2000 - 2001
BMW	X5	V8, 4.6 L	2002 - 2002

**38216**

Acero Lisa/Posterior (70 mm x 17 mm x 32 mm) - c/Damper Hidráulico



TOYOTA	RAV 4	4 CIL. 2.4 L	2005 - 2005
TOYOTA	RAV 4	4 CIL. 2.4 L	2004 - 2006
TOYOTA	RAV 4	4 CIL. 2.0 L	2003 - 2003
TOYOTA	CAMRY	4 CIL. 2.4 L	2003 - 2006
TOYOTA	RAV 4	4 CIL. 2.4 L	2007 - 2007

**38219**



BMW	740IL	V8, 4.4 L	1998 - 2001
BMW	X5	V8, 4.6 L	2002 - 2002
BMW	M5	V8, 5.0 L	2000 - 2001
BMW	X5	V8, 4.4 L	2000 - 2000
BMW	740I	V8, 4.4 L	1998 - 2001

BMW	540I	V8, 4.4 L	1998	-	2003
-----	------	-----------	------	---	------

**38220**



BMW	323I	6 CIL. 2.5 L	1999	-	1999
BMW	Z3	6 CIL. 2.8 L	1998	-	1998

**38221**



BMW	Z3	6 CIL. 2.8 L	1998	-	1998
BMW	Z3	6 CIL. 3.2 L	1998	-	1998
BMW	530I	6 CIL. 3.0 L	2002	-	2002
BMW	320I	6 CIL. 2.2 L	2005	-	2005
BMW	M3	6 CIL. 3.2 L	2001	-	2002
BMW	325XI	6 CIL. 2.5 L	2004	-	2005
BMW	X5	6 CIL. 3.0 L	2006	-	2006
BMW	525I	6 CIL. 2.5 L	2001	-	2005
BMW	X5	V6, 3.0 L	2004	-	2004
BMW	330XI	6 CIL. 3.0 L	2001	-	2005
BMW	X5	6 CIL. 3.0 L	2005	-	2005
BMW	330CI	6 CIL. 3.0 L	2001	-	2003
BMW	X3	6 CIL. 3.0 L	2005	-	2006

**38222**



BMW	318TI	4 CIL. 1.8 L	1995	-	1995
BMW	318IS	4 CIL. 1.8 L	1995	-	1994
BMW	318I	4 CIL. 1.8 L	1995	-	1994

**38223**

Termoplástico Lisa/Posterior (70 mm x 17 mm x 26.4 mm)



BMW	318I	4 CIL. 1.9 L	1998	-	1999
BMW	318TI	4 CIL. 1.9 L	1998	-	1999
BMW	Z3	4 CIL. 1.9 L	1998	-	1998

**38224**

Termoplástico Lisa/Posterior (70 mm x 17 mm x 26 mm)

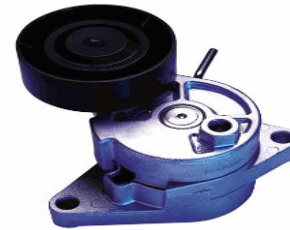

BMW	525I	6 CIL. 2.5 L	2001	-	2002
BMW	318I	V6, 2.8 L	1999	-	1999
BMW	330CI	6 CIL. 3.0 L	2001	-	2002
BMW	328I	V6, 2.8 L	2000	-	2000
BMW	530I	6 CIL. 3.0 L	2002	-	2002
BMW	330XI	6 CIL. 3.0 L	2001	-	2001
BMW	528I	V6, 2.8 L	2000	-	2000
BMW	528I	V6, 2.8 L	1999	-	1999
BMW	M3	6 CIL. 3.2 L	2001	-	2002

**38225**



MERCEDES-BE	SLK230	4 CIL. 2.3 L	2001	-	2004
-------------	--------	--------------	------	---	------

**38226**

Termoplástico Lisa/Posterior (90.2 mm x 17 mm x 22.8 mm)



SAAB	9 - 3	4 CIL. 2.0 L	2000 - 2000
SAAB	9 - 5	4 CIL. 2.3 L	2000 - 2000
SAAB	9 - 3	4 CIL. 2.3 L	2000 - 2000
SAAB	9 - 3	4 CIL. 2.3 L	2001 - 2001
SAAB	9 - 3	4 CIL. 2.0 L	2002 - 2002
SAAB	9 - 5	V6, 3.0 L	2003 - 2003
SAAB	9 - 5	4 CIL. 2.3 L	2002 - 2002

**38246**

Acero Lisa/Posterior (90 mm x 17 mm x 30.5 mm)



LAND ROVER	DISCOVERY	V8, 4.0 L	1999 - 1999
------------	-----------	-----------	-------------

**38247**

Acero Lisa/Posterior (82 mm x 17 mm x 27 mm)



CHEVROLET	CAVALIER	4 CIL. 2.4 L	1999 - 2002
CHEVROLET	CAVALIER Z24	4 CIL. 2.4 L	1998 - 2002
PONTIAC	SUNFIRE	4 CIL. 2.4 L	1999 - 2002
PONTIAC	GRAND AM	4 CIL. 2.4 L	2001 - 2001

**38228**



BMW	318i	V6, 2.8 L	2000 - 2000
-----	------	-----------	-------------

**38249**



MERCURY	COUGAR	V8, 5.0 L	1992 - 1992
---------	--------	-----------	-------------

**38245**

Termoplástico V-Ranurada 7 costillas (90 mm x 17 mm x 32 mm)



LAND ROVER	RANGE ROVER	V8, 4.0 L	1998 - 1998
LAND ROVER	DISCOVERY SERIE	V8, 4.0 L	1999 - 2001
LAND ROVER	RANGE ROVER	V8, 4.6 L	1998 - 1998
LAND ROVER	RANGE ROVER	V8, 4.6 L	1999 - 2002
LAND ROVER	RANGE ROVER	V8, 4.0 L	1999 - 2000
LAND ROVER	DISCOVERY	V8, 4.0 L	1999 - 2002

**38250**

Acero Lisa/Posterior (76 mm x 17 mm x 30.5 mm)



FORD	CONTOUR	V6, 2.5 L	1995 - 2000
MERCURY	MYSTIQUE	V6, 2.5 L	1999 - 2000
MERCURY	MYSTIQUE	V6, 2.5 L	1995 - 1998



**38251**

Acero Lisa/Posterior (76 mm x 17 mm x 30.5 mm)



LINCOLN	CONTINENTAL	V8, 4.6 L	1997	-	2002
---------	-------------	-----------	------	---	------

**38260**

Termoplástico V-Ranurada 6 costillas (76 mm x 17 mm x 25 mm)



CHEVROLET	SUBURBAN	V8, 8.1 L	2001	-	2006
CHEVROLET	SILVERADO PICKU	V8, 8.1 L	2001	-	2005
CHEVROLET	AVALANCHE	V8, 8.1 L	2002	-	2006

**38257**



FORD	EXCURSION	V8, 6.0 L	2005	-	2005
------	-----------	-----------	------	---	------

**38263**



**38258**

Acero Lisa/Posterior (76 mm x 17 mm x 30.5 mm)



CHEVROLET	C & K SERIES PICKU	V8, 8.1 L	2001	-	2002
CHEVROLET	EXPRESS	V8, 8.1 L	2001	-	2002
GMC	SAVANA	V8, 8.1 L	2002	-	2001

MERCEDES-BE	190E	6 CIL. 2.6 L	1993	-	1987
MERCEDES-BE	C280	6 CIL. 2.8 L	1997	-	1994
MERCEDES-BE	SL320	6 CIL. 3.2 L	1997	-	1994
MERCEDES-BE	E320	6 CIL. 3.2 L	1995	-	1994
MERCEDES-BE	S320	6 CIL. 3.2 L	1999	-	1994
MERCEDES-BE	300CE	6 CIL. 3.0 L	1992	-	1988
MERCEDES-BE	260E	6 CIL. 2.6 L	1989	-	1987
MERCEDES-BE	300CE	6 CIL. 3.2 L	1993	-	1993
MERCEDES-BE	300E	6 CIL. 2.6 L	1992	-	1990
MERCEDES-BE	300SL	6 CIL. 3.0 L	1993	-	1990
MERCEDES-BE	300SEL	6 CIL. 3.0 L	1991	-	1988
MERCEDES-BE	300SE	6 CIL. 3.2 L	1992	-	1992
MERCEDES-BE	300SE	6 CIL. 3.0 L	1991	-	1988
MERCEDES-BE	300TE	6 CIL. 3.0 L	1993	-	1988
MERCEDES-BE	300TE	6 CIL. 3.2 L	1993	-	1993
MERCEDES-BE	300E	6 CIL. 3.2 L	1993	-	1993
MERCEDES-BE	300E	6 CIL. 3.0 L	1993	-	1986
MERCEDES-BE	300E	6 CIL. 2.8 L	1993	-	1993

**38259**

Acero Lisa/Posterior (63 mm x 17 mm x 18 mm)



CHEVROLET	SILVERADO PICKU	V8, 8.1 L	2004	-	2006
CHEVROLET	AVALANCHE	V8, 8.1 L	2002	-	2006
CHEVROLET	SUBURBAN	V8, 8.1 L	2001	-	2006

**38264**



MERCEDES-BE	190E	4 CIL. 2.3 L	1993	-	1985
-------------	------	--------------	------	---	------

**38268**

Termoplástico Lisa/Posterior (76 mm x 17 mm x 26 mm)



OLDSMOBILE	EIGHTY EIGHT	V6, 3.8 L	1995	-	1995
PONTIAC	BONNEVILLE	V6, 3.8 L	1994	-	1995

**38266**



ACURA	SLX	V6, 3.5 L	1999	-	1999
-------	-----	-----------	------	---	------

**38269**

Termoplástico Lisa/Posterior (76 mm x 17 mm x 26 mm)



PONTIAC	BONNEVILLE	V6, 3.8 L	1995	-	1995
OLDSMOBILE	EIGHTY EIGHT	V6, 3.8 L	1995	-	1995

**38267**



CHEVROLET	BLAZER FULL SIZE	V8, 6.5 L Diesel	1994	-	1994
CHEVROLET	SUBURBAN	V8, 6.5 L Diesel	1995	-	1994
CHEVROLET	TAHOE	V8, 6.5 L Diesel	1995	-	1995
GMC	C & K SERIES PICK	V8, 6.2 L Diesel	1993	-	1988
GMC	C & K SERIES PICK	V8, 6.5 L Diesel	1995	-	1992
CHEVROLET	C & K SERIES PICK	V8, 6.5 L Diesel	1995	-	1992
GMC	YUKON	V8, 6.5 L Diesel	1995	-	1994
CHEVROLET	C & K SERIES PICK	V8, 6.2 L Diesel	1993	-	1988

**38270**



FORD	E SERIES VAN	V8, 7.3 L	1995	-	1995
------	--------------	-----------	------	---	------

**38271**

Acero Lisa/Posterior (76 mm x 17 mm x 31 mm)



CHEVROLET	IMPALA	V6, 3.8 L	2003	-	2003
CHEVROLET	IMPALA	V6, 3.8 L	2005	-	2005
CHEVROLET	IMPALA	V6, 3.8 L	2000	-	2004
PONTIAC	BONNEVILLE	V6, 3.8 L	2003	-	2005

PONTIAC	GRAND PRIX	V6, 3.8 L	2003 - 2005
---------	------------	-----------	-------------

**38273**



CHEVROLET	EPICA	6 CIL. 2.5 L	2006 - 2006
-----------	-------	--------------	-------------

**38274**

Acero Lisa/Posterior (76 mm x 17 mm x 30.5 mm)



FORD	MUSTANG	V8, 4.6 L	2008 - 2010
FORD	MUSTANG	V8, 4.6 L	2005 - 2007
FORD	LOBO	V8, 4.6 L	2002 - 2007
FORD	F SERIES PICKUP	V8, 5.4 L	2002 - 2002
FORD	EXPEDITION	V8, 4.6 L	2004 - 2004
FORD	F-250	V8, 4.6 L	2002 - 2007
FORD	F-350 SUPER DUTY	V8, 5.4 L	2007 - 2010
FORD	F-350 SUPER DUTY	V8, 5.4 L	2002 - 2004
FORD	F-450 SUPER DUTY	V10, 6.8 L	2007 - 2010
FORD	E SERIES VAN	V8, 4.6 L	2008 - 2010
FORD	LOBO	V8, 4.6 L	2008 - 2010
FORD	EXPLORER SPORT	V8, 4.6 L	2007 - 2010
FORD	LOBO	V8, 5.4 L	2008 - 2010
FORD	LOBO	V8, 5.4 L	2005 - 2007
FORD	SUPER DUTY PICK	V10, 6.8 L	2002 - 2003
FORD	SUPER DUTY PICK	V8, 5.4 L	2002 - 2003
FORD	SUPER DUTY VAN	V10, 6.8 L	2002 - 2002
FORD	SUPER DUTY VAN	V8, 4.6 L	2003 - 2003
FORD	SUPER DUTY VAN	V8, 5.4 L	2002 - 2002
FORD	F-550 SUPER DUTY	V10, 6.8 L	2008 - 2010
FORD	EXPEDITION	V8, 4.6 L	2002 - 2003

FORD	E SERIES VAN	V8, 4.6 L	2004 - 2006
FORD	E SERIES VAN	V8, 4.6 L	2002 - 2003
FORD	E SERIES VAN	V8, 5.4 L	2008 - 2010
FORD	E SERIES VAN	V8, 5.4 L	2006 - 2007
FORD	E SERIES VAN	V8, 5.4 L	2002 - 2005
FORD	F-150	V8, 4.6 L	2008 - 2010
FORD	EXCURSION	V10, 6.8 L	2002 - 2003
FORD	EXPLORER	V8, 4.6 L	2002 - 2004
FORD	EXPEDITION	V8, 5.4 L	2005 - 2010
FORD	EXPEDITION	V8, 5.4 L	2004 - 2004
FORD	EXPEDITION	V8, 5.4 L	2002 - 2003
FORD	EXPLORER	V8, 4.6 L	2007 - 2010
FORD	EXPLORER	V8, 4.6 L	2005 - 2007
FORD	EXCURSION	V10, 6.8 L	2004 - 2005
LINCOLN	AVIATOR	V8, 4.6 L	2003 - 2005
LINCOLN	NAVIGATOR	V8, 5.4 L	2008 - 2009
LINCOLN	NAVIGATOR	V8, 5.4 L	2002 - 2002
LINCOLN	MARK LT	V8, 5.4 L	2007 - 2008
LINCOLN	NAVIGATOR	V8, 5.4 L	2003 - 2007
MERCURY	MOUNTAINEER	V8, 4.6 L	2003 - 2002

**38275**

Acero Lisa/Posterior (76 mm x 17 mm x 30.5 mm)



FORD	FOCUS	4 CIL. 2.0 L	2000 - 2004
------	-------	--------------	-------------

**38276**

Termoplástico V-Ranurada 3 costillas (52 mm x 8 mm x 13 mm)



FORD	CONTOUR	V6, 2.5 L	1996 - 2000
FORD	ESCAPE	V6, 3.0 L	2001 - 2003

FORD ESCAPE V6, 3.0 L 2004 - 2007

**38277**

Termoplástico Lisa/Posterior (70 mm x 17 mm x 19 mm)



DODGE NEON 4 CIL. 2.0 L 2004 - 2006

**38278**

Acero Lisa/Posterior (76.5 mm x 17 mm x 37.5 mm)



ACURA	TSX	4 CIL. 2.4 L	2006 - 2006
ACURA	RDX	4 CIL. 2.3 L	2006 - 2010
HONDA	ACCORD	4 CIL. 2.4 L	2005 - 2006
HONDA	ACCORD	4 CIL. 2.4 L	2003 - 2007
HONDA	ACCORD	4 CIL. 2.4 L	2004 - 2004
HONDA	ELEMENT	4 CIL. 2.4 L	2004 - 2003
HONDA	CR-V	4 CIL. 2.4 L	2004 - 2004
HONDA	CR-V	4 CIL. 2.4 L	2005 - 2006
HONDA	CR-V	4 CIL. 2.4 L	2007 - 2009

**38279**

Acero Lisa/Posterior (76 mm x 17 mm x 30.5 mm)



FORD	FUSION	V6, 3.0 L	2007 - 2009
FORD	ESCAPE	V6, 3.0 L	2005 - 2006
FORD	ESCAPE	V6, 3.0 L	2007 - 2007
FORD	ESCAPE	V6, 3.0 L	2008 - 2009
FORD	FIVE HUNDRED	V6, 3.0 L	2005 - 2005

JAGUAR	S-TYPE	V8, 4.0 L	2000 - 2000
JAGUAR	X-TYPE	V6, 3.0 L	2005 - 2002
JAGUAR	X-TYPE	V6, 2.5 L	2005 - 2002
LINCOLN	LS	V8, 3.9 L	2003 - 2006
FORD	FIVE HUNDRED	V6, 3.0 L	2006 - 2007
LINCOLN	LS	V8, 3.9 L	2000 - 2002
LINCOLN	LS	V6, 3.0 L	2000 - 2000
LINCOLN	LS	V6, 3.0 L	2001 - 2001
MERCURY	MILAN	V6, 3.0 L	2006 - 2009
MERCURY	MARINER	V6, 3.0 L	2007 - 2009

**38284**

Acero Lisa/Posterior (82.5 mm x 17 mm x 31 mm)



NISSAN	SENTRA	4 CIL. 2.5 L	2003 - 2006
NISSAN	ALTIMA	4 CIL. 2.4 L	2004 - 2004
NISSAN	ALTIMA	4 CIL. 2.5 L	2003 - 2006

**38285**

Acero Lisa/Posterior (76 mm x 39 mm)



DODGE	RAM 4000	V6, 5.9 L DIESEL	2008 - 2008
DODGE	RAM 4000	V6, 6.7 L DIESEL	2008 - 2009
DODGE	RAM 4000	V6, 5.9 L DIESEL	2003 - 2007

**38286**

Termoplástico Lisa/Posterior (70 mm x 17 mm x 25 mm)



TOYOTA	MATRIX	4 CIL. 1.8 L	2004	-	2006
TOYOTA	CELICA	4 CIL. 1.8 L	2005	-	2005
TOYOTA	COROLLA	4 CIL. 1.8 L	2007	-	2008
TOYOTA	MATRIX	4 CIL. 1.8 L	2003	-	2003
TOYOTA	COROLLA	4 CIL. 1.8 L	2002	-	2005
TOYOTA	MATRIX	4 CIL. 1.8 L	2007	-	2008
TOYOTA	COROLLA	4 CIL. 1.8 L	2006	-	2006

**38288**



LINCOLN	TOWN CAR	V8, 4.6 L	1991	-	1991
---------	----------	-----------	------	---	------

**38289**

Termoplástico Lisa/Posterior (76 mm x 17 mm x 26 mm)



CHEVROLET	CAMARO	V6, 3.8 L	2002	-	2002
OLDSMOBILE	EIGHTY EIGHT	V6, 3.8 L	1999	-	1999

**38291**

Acero V-Ranurada 6 costillas (76 mm x 17 mm x 30 mm)



FORD	F-150	V6, 4.2 L	2003	-	2006
------	-------	-----------	------	---	------

**38297**

Termoplástico Lisa/Posterior (70 mm x 17 mm x 34 mm)



FORD	THUNDERBIRD	V6, 3.8 L	1994	-	1995
------	-------------	-----------	------	---	------

**38298**

Acero Lisa/Posterior (76 mm x 17 mm x 37 mm)



FORD	THUNDERBIRD	V6, 3.8 L	1994	-	1995
------	-------------	-----------	------	---	------

**38299**

Acero Lisa/Posterior (76.2 mm x 17 mm x 37 mm)



FORD	THUNDERBIRD	V6, 3.8 L	1994	-	1995
------	-------------	-----------	------	---	------

**38304**



VOLVO	S70	5 CIL. 2.4 L	1998	-	1998
VOLVO	V70	5 CIL. 2.4 L	1998	-	1998
VOLVO	S70	5 CIL. 2.3 L	1998	-	1998
VOLVO	V70	5 CIL. 2.3 L	1998	-	1998
VOLVO	850	5 CIL. 2.4 L	1997	-	1993
VOLVO	C70	5 CIL. 2.4 L	1998	-	1998

VOLVO	850	5 CIL. 2.3 L	1997	-	1994
VOLVO	960	6 CIL. 2.9 L	1994	-	1992
VOLVO	C70	5 CIL. 2.3 L	1998	-	1998

**38308**



MAZDA	MAZDA 6	V6, 3.0 L	2005	-	2005
-------	---------	-----------	------	---	------

**38314**

Termoplástico Lisa/Posterior (65 mm x 17 mm x 22 mm)



VOLKSWAGEN	BORA	5 CIL. 2.5 L	2005	-	2009
VOLKSWAGEN	BORA SPORTWAG	5 CIL. 2.5 L	2008	-	2009
VOLKSWAGEN	BEETLE	5 CIL. 2.5 L	2009	-	2010

**38315**

Termoplástico Lisa/Posterior (65 mm x 17 mm x 22 mm)



VOLKSWAGEN	BORA SPORTWAG	5 CIL. 2.5 L	2008	-	2009
VOLKSWAGEN	BEETLE	5 CIL. 2.5 L	2009	-	2010
VOLKSWAGEN	BORA	5 CIL. 2.5 L	2005	-	2009

**38317**

Termoplástico V-Ranurada 7 costillas (70 mm x 17 mm x 29 mm)



AUDI	Q7	V6, 3.6 L	2008	-	2009
AUDI	Q7	V6, 3.6 L	2007	-	2007
VOLKSWAGEN	TOUAREG	V6, 3.6 L	2007	-	2008
VOLKSWAGEN	TOUAREG	V6, 3.2 L	2006	-	2006

**38322**

Acero Lisa/Posterior (85 mm x 17 mm x 31 mm) - c/Damper Hidráulico



HONDA	ODYSSEY	V6, 3.5 L	2002	-	2003
HONDA	ODYSSEY	V6, 3.5 L	2004	-	2004

**38323**

Termoplástico Lisa/Posterior (70 mm x 17 mm x 26 mm)



DODGE	DURANGO	V8, 5.7 L	2008	-	2009
CHRYSLER	300	V6, 2.7 L	2005	-	2005
CHRYSLER	PACIFICA	V6, 3.5 L	2004	-	2005
JEEP	GRAND CHEROKE	V8, 6.1 L	2008	-	2009
JEEP	GRAND CHEROKE	V8, 5.7 L	2006	-	2006
DODGE	CHARGER	V8, 6.1 L	2007	-	2009
DODGE	CHARGER	V8, 5.7 L	2007	-	2009
JEEP	GRAND CHEROKE	V8, 5.7 L	2005	-	2007
DODGE	CHARGER	V6, 3.5 L	2007	-	2009
CHRYSLER	PACIFICA	V6, 3.5 L	2006	-	2006

DODGE	JOURNEY	4 CIL. 2.4 L	2009	-	2010
CHRYSLER	300 C	V6, 3.5 L	2007	-	2009
JEEP	COMMANDER	V8, 5.7 L	2006	-	2009
CHRYSLER	300 C	V8, 6.1 L	2005	-	2006
CHRYSLER	300 C	V8, 5.7 L	2005	-	2006
CHRYSLER	300 C	V8, 5.7 L	2007	-	2009
CHRYSLER	300 C	V6, 3.5 L	2005	-	2006
JEEP	GRAND CHEROKE	V8, 5.7 L	2008	-	2009
DODGE	RAM 2500	V8, 5.7 L	2009	-	2009
JEEP	GRAND CHEROKE	V8, 6.1 L	2006	-	2006
JEEP	GRAND CHEROKE	V8, 6.1 L	2007	-	2007
VOLKSWAGEN	ROUTAN	V6, 3.8 L	2009	-	2010

**38329**

Acero V-Ranurada 6 costillas (76 mm x 17 mm x 30 mm) -



FORD	SUPER DUTY VAN	V8, 4.6 L	2003	-	2003
FORD	SUPER DUTY VAN	V8, 5.4 L	2002	-	2002
FORD	LOBO	V8, 5.4 L	2008	-	2008
FORD	E SERIES VAN	V8, 4.6 L	2004	-	2006
FORD	LOBO	V8, 4.6 L	2005	-	2007
FORD	LOBO	V8, 5.4 L	2005	-	2007
FORD	F-550 SUPER DUTY	V10, 6.8 L	2008	-	2010
FORD	F SERIES PICKUP	V8, 5.4 L	2002	-	2002
FORD	F-150	V8, 4.6 L	2008	-	2008
FORD	F-250	V8, 4.6 L	2002	-	2007
FORD	F-350 SUPER DUTY	V8, 5.4 L	2007	-	2010
FORD	F-450 SUPER DUTY	V10, 6.8 L	2007	-	2010
FORD	LOBO	V8, 4.6 L	2008	-	2008
FORD	E SERIES VAN	V8, 4.6 L	2002	-	2005
FORD	SUPER DUTY PICKUP	V8, 5.4 L	2002	-	2003
FORD	SUPER DUTY PICKUP	V10, 6.8 L	2002	-	2003
FORD	SUPER DUTY VAN	V10, 6.8 L	2002	-	2002
FORD	E SERIES VAN	V8, 4.6 L	2008	-	2010
FORD	E SERIES VAN	V8, 5.4 L	2002	-	2005
FORD	E SERIES VAN	V8, 5.4 L	2006	-	2007
FORD	E SERIES VAN	V8, 5.4 L	2008	-	2010
LINCOLN	MARK LT	V8, 5.4 L	2007	-	2008

**38327**

Acero Lisa/Posterior (90 mm x 17 mm x 29 mm)



ACURA	MDX	V6, 3.5 L	2002	-	2002
HONDA	ODYSSEY	V6, 3.5 L	2001	-	2001
HONDA	PILOT	V6, 3.5 L	2003	-	2004

**38328**

Termoplástico V-Ranurada 6 costillas (70 mm x 17 mm x 30 mm)



CADILLAC	CTS	V8, 5.7 L	2005	-	2005
CHEVROLET	CORVETTE	V8, 6.0 L	2005	-	2007
PONTIAC	G8	V8, 6.0 L	2009	-	2009

**38330**

Acero V-Ranurada 8 costillas (76 mm x 17 mm x 38 mm)



FORD	F-250	V8, 4.6 L	1998	-	2001
------	-------	-----------	------	---	------

FORD	F-350 SUPER DUTY	V8, 5.4 L	2002	-	2006
FORD	F SERIES PICKUP	V8, 4.6 L	1998	-	2001
FORD	E SERIES VAN	V8, 4.6 L	1999	-	2001
FORD	F SERIES PICKUP	V8, 5.4 L	1999	-	2001
FORD	E SERIES VAN	V8, 5.4 L	1997	-	2001
FORD	E SERIES VAN	V10, 6.8 L	1997	-	1998
FORD	SUPER DUTY VAN	V8, 5.4 L	1999	-	2001
FORD	SUPER DUTY PICK	V10, 6.8 L	1999	-	2000
FORD	SUPER DUTY PICK	V8, 5.4 L	1999	-	2001
FORD	SUPER DUTY VAN	V10, 6.8 L	1999	-	2001

**38332**

Acero Lisa/Posterior (76.3 mm x 17 mm x 29.5 mm); Acero Lisa/Posterior (76 mm x 17 mm x 30.5 mm)



ACURA	TL	V6, 3.2 L	2008	-	2008
HONDA	ODYSSEY	V6, 3.5 L	2008	-	2010
ACURA	RL	V6, 3.5 L	2008	-	2008
ACURA	RL	V6, 3.5 L	2006	-	2007
ACURA	RL	V6, 3.7 L	2009	-	2010
HONDA	ODYSSEY	V6, 3.5 L	2005	-	2007
HONDA	ACCORD	V6, 3.0 L	2003	-	2007
ACURA	TL	V6, 3.2 L	2006	-	2007
HONDA	ACCORD	V6, 3.0 L	2005	-	2006
ACURA	TL	V6, 3.5 L	2008	-	2008
ACURA	MDX	V6, 3.7 L	2007	-	2007
HONDA	PILOT	V6, 3.5 L	2005	-	2007
ACURA	MDX	V6, 3.5 L	2006	-	2006
ACURA	MDX	V6, 3.7 L	2008	-	2010
HONDA	RIDGELINE	V6, 3.5 L	2006	-	2007
HONDA	PILOT	V6, 3.5 L	2008	-	2008
HONDA	RIDGELINE	V6, 3.5 L	2008	-	2010

**38339**



FORD	FUSION	4 CIL. 2.3 L	2007	-	2009
------	--------	--------------	------	---	------

**38340**

Acero Lisa/Posterior (102.5 mm x 17 mm x 34.5 mm)



NISSAN	ARMADA	V8, 5.6 L	2006	-	2006
NISSAN	TITAN	V8, 5.6 L	2004	-	2005
NISSAN	TITAN	V8, 5.6 L	2006	-	2009
NISSAN	ARMADA	V8, 5.6 L	2006	-	2010

**38341**



SATURN	VUE	V6, 3.5 L	2007	-	2007
--------	-----	-----------	------	---	------

**38350**

Termoplástico V-Ranurada 7 costillas (76 mm x 17 mm x 32 mm) -



DODGE	VIPER	V10, 8.0 L	1998	-	2002
-------	-------	------------	------	---	------



**38357**

Acero V-Ranurada 6 costillas (70 mm x 17 mm x 28 mm) -



MAZDA	MAZDA 3	4 CIL. 2.0 L	2006 - 2008
MAZDA	MAZDA 5	4 CIL. 2.3 L	2006 - 2007
MAZDA	MAZDA 3	4 CIL. 2.3 L	2006 - 2008

**38382**

Termoplástico V-Ranurada 7 costillas (80 mm x 17 mm x 32 mm)



DODGE	RAM 3500	V8, 5.7 L	2003 - 2007
DODGE	RAM 2500	V8, 5.7 L	2008 - 2008
DODGE	DURANGO	V8, 5.7 L	2006 - 2007
CHRYSLER	ASPEN	V8, 5.7 L	2007 - 2009

**38376**

Termoplástico Lisa/Posterior (76 mm x 17 mm x 26 mm)



CHEVROLET	AVEO	4 CIL. 1.6 L	2008 - 2008
SUZUKI	SWIFT	4 CIL. 1.6 L	2006 - 2008
PONTIAC	G3	4 CIL. 1.6 L	2006 - 2008

**38384**

Termoplástico Lisa/Posterior (70 mm x 17 mm x 25 mm)



BMW	X5	6 CIL. 3.0 L	2005 - 2006
BMW	X3	6 CIL. 3.0 L	2005 - 2006
BMW	325CI	V6, 2.5 L	2006 - 2006
BMW	325I	V6, 2.5 L	2005 - 2005
BMW	325XI	V6, 3.0 L	2006 - 2006
BMW	325I	V6, 3.0 L	2006 - 2006

**38378**

Acero Lisa/Posterior (76 mm x 17 mm x 36.3 mm)



NISSAN	PATHFINDER	V6, 4.0 L	2005 - 2006
NISSAN	XTERRA	V6, 4.0 L	2007 - 2007
NISSAN	XTERRA	V6, 4.0 L	2006 - 2006
NISSAN	PATHFINDER	V6, 4.0 L	2007 - 2010
NISSAN	FRONTIER	V6, 4.0 L	2006 - 2006
NISSAN	FRONTIER	V6, 4.0 L	2007 - 2008

**38385**

Acero Lisa/Posterior (76 mm x 17 mm x 30.5 mm) - c/Tornillo



FORD	MUSTANG SHELBY	V8, 5.4 L	2009 - 2010
------	----------------	-----------	-------------

**38397**

Acero Lisa/Posterior (70 mm x 17 mm x 31 mm)



BUICK	ENCLAVE	V6, 3.6 L	2010	-	2010
CHEVROLET	TRAVERSE	V6, 3.6 L	2010	-	2011
GMC	ACADIA	V6, 3.6 L	2007	-	2010
CHEVROLET	MALIBU	V6, 3.6 L	2008	-	2010
BUICK	LACROSSE	V6, 3.6 L	2010	-	2010
CHEVROLET	CAPTIVA	V6, 3.6 L	2008	-	2008
SAAB	9 - 3	V6, 2.8 L	2006	-	2007
SUZUKI	XL-7	V6, 3.6 L	2007	-	2009
PONTIAC	G8	V6, 3.6 L	2009	-	2009
PONTIAC	G6	V6, 3.6 L	2007	-	2008
SUZUKI	GRAND VITARA	V6, 3.2 L	2009	-	2010

**38406**

Acero Lisa/Posterior (70 mm x 17 mm x 24 mm)



AUDI	A4	V6, 3.0 L	2006	-	2006
------	----	-----------	------	---	------

**38408**

Termoplástico V-Ranurada 6 costillas (70 mm x 17 mm x 25 mm) - , c/2 Tornillos



FORD	ESCAPE	4 CIL. 2.3 L	2005	-	2007
MAZDA	MAZDA 3	4 CIL. 2.3 L	2006	-	2006
MERCURY	MARINER	4 CIL. 2.3 L	2005	-	2007
MAZDA	MAZDA 6	4 CIL. 2.3 L	2006	-	2007
MAZDA	MAZDA 3	4 CIL. 2.3 L	2006	-	2008

**38404**

Acero Lisa/Posterior (65 mm x 17 mm x 26 mm) - c/Resorte & Damper Hidráulico



MINI	COOPER	4 CIL. 1.6 L	2005	-	2008
------	--------	--------------	------	---	------

**38409**

Termoplástico V-Ranurada 6 costillas (70 mm x 17 mm x 25 mm) - , c/2 Tornillos



MAZDA	MAZDA 6	4 CIL. 2.3 L	2006	-	2007
MAZDA	MAZDA 3	4 CIL. 2.3 L	2010	-	2010

**38405**

Termoplástico Lisa/Posterior (70 mm x 17 mm x 24 mm)



MINI	COOPER	4 CIL. 1.6 L	2005	-	2007
------	--------	--------------	------	---	------

**38410**

Acero Lisa/Posterior (70 mm x 17 mm x 33.3 mm)



TOYOTA	RAV 4	V6, 3.5 L	2008	-	2010
--------	-------	-----------	------	---	------

TOYOTA	HIGHLANDER	V6, 3.5 L	2008	-	2010
TOYOTA	CAMRY	V6, 3.5 L	2009	-	2011
TOYOTA	SIENNA	V6, 3.5 L	2007	-	2011

**38411**

Acero Lisa/Posterior (70 mm x 17 mm x 33.3 mm)



TOYOTA	TACOMA	V6, 4.0 L	2009	-	2010
TOYOTA	FJ CRUISER	V6, 4.0 L	2007	-	2008

**38417**

Termoplástico Lisa/Posterior (70 mm x 17 mm x 24 mm)



CHRYSLER	PACIFICA	V6, 4.0 L	2007	-	2008
CHRYSLER	TOWN & COUNTRY	V6, 4.0 L	2008	-	2010
CHRYSLER	TOWN & COUNTRY	V6, 4.0 L	2008	-	2008
DODGE	JOURNEY	V6, 3.5 L	2010	-	2009

**38418**

Acero Lisa/Posterior (70 mm x 17 mm x 31 mm)



**38413**

Acero Lisa/Posterior (80 mm x 17 mm x 28.5 mm)



TOYOTA	TACOMA	V6, 4.0 L	2009	-	2010
TOYOTA	FJ CRUISER	V6, 4.0 L	2007	-	2008

CADILLAC	CTS	V6, 3.6 L	2007	-	2007
----------	-----	-----------	------	---	------

**38419**

Acero Lisa/Posterior (70 mm x 17 mm x 31 mm)



**38415**

Termoplástico Lisa/Posterior (70 mm x 8 mm x 26 mm)



TOYOTA	TACOMA	V6, 4.0 L	2009	-	2010
TOYOTA	FJ CRUISER	V6, 4.0 L	2007	-	2008

CADILLAC	CTS	V6, 3.6 L	2007	-	2007
----------	-----	-----------	------	---	------

**38420**

Termoplástico V-Ranurada 6 costillas (74 mm x 17 mm x 26 mm)



**38416**

Termoplástico V-Ranurada 6 costillas (70 mm x 17 mm x 25 mm)



FORD	MUSTANG	V6, 4.0 L	2008	-	2010
------	---------	-----------	------	---	------

CHEVROLET	MALIBU	V6, 3.5 L	2007	-	2007
CHEVROLET	UPLANDER	V6, 3.5 L	2007	-	2007
CHEVROLET	UPLANDER	V6, 3.9 L	2007	-	2007

CHEVROLET	UPLANDER	V6, 3.9 L	2008 - 2009
PONTIAC	G6	V6, 3.5 L	2007 - 2008
PONTIAC	MONTANA	V6, 3.9 L	2006 - 2008

**38423**

Termoplástico Lisa/Posterior (76 mm x 17 mm x 26 mm) - c/Tornillo



AUDI	Q5	V6, 3.2 L	2009 - 2009
AUDI	A4	V6, 3.2 L	2006 - 2009
AUDI	A6	V6, 3.2 L	2006 - 2008

**38450**

Termoplástico V-Ranurada 6 costillas (62 mm x 17 mm x 25 mm) - c/Cubre Polvo



AUDI	A3	V6, 3.2 L	2007 - 2008
------	----	-----------	-------------

**38451**

Acero Lisa/Posterior (70 mm x 17 mm x 30.5 mm)



AUDI	A8	V8, 4.2 L	2007 - 2007
------	----	-----------	-------------

**38452**

Termoplástico V-Ranurada 6 costillas (68 mm x 17 mm x 26.4 mm)



FORD	FUSION	4 CIL. 2.3 L	2007 - 2009
------	--------	--------------	-------------

FORD	ESCAPE	4 CIL. 2.5 L	2009 - 2010
FORD	FOCUS	4 CIL. 2.0 L	2007 - 2010
FORD	ESCAPE	4 CIL. 2.3 L	2008 - 2008
FORD	FUSION	4 CIL. 2.5 L	2010 - 2010
MERCURY	MILAN	4 CIL. 2.5 L	2010 - 2010

**38453**

Acero Lisa/Posterior (70 mm x 17 mm x 33 mm)



TOYOTA	MATRIX	4 CIL. 2.4 L	2009 - 2010
TOYOTA	COROLLA	4 CIL. 2.4 L	2009 - 2010
TOYOTA	CAMRY	4 CIL. 2.4 L	2007 - 2009

**38462**

Acero Lisa/Posterior (65 mm x 17 mm x 23 mm)



PONTIAC	G8	V8, 6.0 L	2009 - 2009
---------	----	-----------	-------------

**39051**

Acero Lisa/Posterior (90 mm x 17 mm x 37 mm)



FORD	F-550 SUPER DUTY	V8, 6.4 L DIESEL	2008 - 2010
FORD	F-250 SUPER DUTY	V8, 6.4 L DIESEL	2008 - 2010
FORD	F-450 SUPER DUTY	V8, 6.4 L DIESEL	2008 - 2010

**39052**

Acero Lisa/Posterior (90 mm x 17 mm x 29.5 mm)



FORD	F-250 SUPER DUTY	V8, 6.4 L DIESEL	2008	-	2010
FORD	F-450 SUPER DUTY	V8, 6.4 L DIESEL	2008	-	2010
FORD	F-550 SUPER DUTY	V8, 6.4 L DIESEL	2008	-	2010

ACURA	TSX	4 CIL. 2.4 L	2009	-	2009
HONDA	ACCORD	4 CIL. 2.4 L	2008	-	2010

**39077**

Acero Lisa/Posterior (70 mm x 17 mm x 30.6 mm)



HONDA	CIVIC	4 CIL. 1.8 L	2008	-	2010
-------	-------	--------------	------	---	------

**39053**

Termoplástico Lisa/Posterior (65 mm x 17 mm x 24.5 mm)



DODGE	CALIBER	4 CIL. 2.4 L	2007	-	2009
JEEP	PATRIOT	4 CIL. 2.4 L	2007	-	2010
JEEP	COMPASS	4 CIL. 2.4 L	2007	-	2010
DODGE	AVENGER	4 CIL. 2.4 L	2007	-	2009
DODGE	AVENGER	4 CIL. 2.0 L	2007	-	2009

**39083**

Termoplástico V-Ranurada 6 costillas (76 mm x 17 mm x 28 mm) -



CHEVROLET	SUBURBAN	V8, 6.0 L	2009	-	2010
CHEVROLET	EXPRESS	V8, 6.0 L	2009	-	2010
HUMMER	H2	V8, 6.2 L	2009	-	2010
CHEVROLET	SUBURBAN	V8, 5.3 L	2009	-	2010
CHEVROLET	EXPRESS	V8, 5.3 L	2009	-	2010
GMC	SIERRA	V8, 6.2 L	2009	-	2010
CHEVROLET	AVALANCHE	V8, 5.3 L	2009	-	2010
CHEVROLET	SILVERADO	V8, 4.8 L	2009	-	2010
CADILLAC	ESCALADE	V8, 6.2 L	2009	-	2010
CHEVROLET	TAHOE	V8, 5.3 L	2009	-	2010
GMC	YUKON	V8, 6.2 L	2009	-	2010
GMC	SIERRA	V8, 5.3 L	2009	-	2010
CHEVROLET	SILVERADO	V8, 5.3 L	2009	-	2010

**39070**

Acero V-Ranurada 4 costillas (70 mm x 11 mm x 22 mm)



HONDA	CIVIC HIBRIDO	4 CIL. 1.3 L	2005	-	2010
-------	---------------	--------------	------	---	------

**39073**

Acero Lisa/Posterior (76.5 mm x 17 mm x 37.5 mm)



**39092**

Acero Lisa/Posterior (80 mm x 12 mm x 28.5 mm), Acero Lisa/Posterior (80 mm x 17 mm x 28.5 mm)



HONDA	PILOT	V6, 3.5 L	2009	-	2010
HONDA	ODYSSEY	V6, 3.5 L	2008	-	2010
HONDA	ACCORD	V6, 3.5 L	2008	-	2010

MERCURY	MILAN	V6, 3.0 L	2007	-	2009
MERCURY	MARINER	V6, 3.0 L	2007	-	2009

**T36038**



**91030**



FORD	EDGE	V6, 3.5 L	2007	-	2010
GMC	SIERRA	V8, 6.2 L	2009	-	2010
GMC	YUKON	V8, 6.2 L	2009	-	2010
CHEVROLET	EXPRESS	V8, 6.0 L	2009	-	2010
FIAT	DUCATO	4 CIL. 2.3 L DIESEL	2008	-	2010
CHEVROLET	TAHOE	V8, 5.3 L	2009	-	2010
CHEVROLET	EXPRESS	V8, 5.3 L	2009	-	2010
CHEVROLET	SUBURBAN	V8, 6.0 L	2009	-	2010
CHEVROLET	SILVERADO	V8, 4.8 L	2009	-	2010
CHEVROLET	AVALANCHE	V8, 5.3 L	2009	-	2010
CHEVROLET	SILVERADO	V8, 5.3 L	2009	-	2010
DODGE	NITRO	V6, 4.0 L	2009	-	2010
CHEVROLET	SUBURBAN	V8, 5.3 L	2009	-	2010
HUMMER	H2	V8, 6.2 L	2009	-	2010
FORD	TRANSIT	4 CIL. 2.2 L	2008	-	2010
FORD	FUSION	V6, 3.0 L	2007	-	2009
GMC	SIERRA	V8, 5.3 L	2009	-	2010
CADILLAC	ESCALADE	V8, 6.2 L	2009	-	2010
FIAT	DUCATO	4 CIL. 3.0 L DIESEL	2008	-	2010
FORD	ESCAPE	V6, 3.0 L	2005	-	2009
FORD	FUSION	V6, 3.5 L	2010	-	2010
MAZDA	MAZDA 6	V6, 3.0 L	2008	-	2008
MAZDA	CX-9	V6, 3.7 L	2007	-	2008
MAZDA	MAZDA 3	4 CIL. 2.0 L	2006	-	2008
LINCOLN	MKX	V6, 3.5 L	2007	-	2009
MAZDA	MAZDA 3	4 CIL. 2.3 L	2006	-	2009
LINCOLN	MKZ	V6, 3.5 L	2007	-	2009

CHEVROLET	C & K SERIES PICK	4 CIL. 1.6 L	2003	-	2003
CHEVROLET	MONZA	4 CIL. 1.6 L	1994	-	2004
CHEVROLET	CHEVY SWING	4 CIL. 1.6 L	1994	-	2003
CHEVROLET	CHEVY POP	4 CIL. 1.6 L	1994	-	2003
CHEVROLET	CHEVY PICK-UP	4 CIL. 1.6 L	2002	-	2006
CHEVROLET	CHEVY JOY	4 CIL. 1.6 L	1994	-	2003
CHEVROLET	CHEVY C2 SEDAN	4 CIL. 1.6 L	2004	-	2008
CHEVROLET	CHEVY C2	4 CIL. 1.6 L	2004	-	2008
CHEVROLET	CHEVY	4 CIL. 1.6 L	2009	-	2010

**T36109**

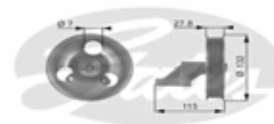

PEUGEOT	307	4 CIL. 2.0 L	2005	-	2008
---------	-----	--------------	------	---	------

**T36124**



FORD	TRANSIT	4 CIL. 2.2 L	2008	-	2010
------	---------	--------------	------	---	------

**T38313**

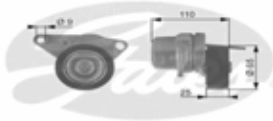

PEUGEOT	207	4 CIL. 1.6 L	2008 - 2009
---------	-----	--------------	-------------

**T38320**



PEUGEOT	307	4 CIL. 2.0 L	2005 - 2008
---------	-----	--------------	-------------

**T38368**



FIAT	BRAVO	4 CIL. 1.4 L	2009 - 2010
FIAT	GRANDE PUNTO	4 CIL. 1.4 L	2009 - 2010

**T38415**



MERCEDES-BE	SPRINTER	4 CIL. 2.2 L	2007 - 2007
MERCEDES-BE	SPRINTER	4 CIL. 2.2 L CDI	2006 - 2007
MERCEDES-BE	SPRINTER	5 CIL. 2.7 L CDI	2003 - 2005

**T38428**



RENAULT	MEGANE	4 CIL. 2.0 L	2004 - 2009
RENAULT	SCENIC	4 CIL. 2.0 L	2004 - 2009

**T38433**



CHEVROLET	CRUZE	4 CIL. 1.8 L	2010 - 2011
-----------	-------	--------------	-------------

**T38456**



NISSAN	PLATINA	4 CIL. 1.6 L	2002 - 2010
RENAULT	KANGOO	4 CIL. 1.6 L	2003 - 2010
NISSAN	APRIO	4 CIL. 1.6 L	2008 - 2010
RENAULT	CLIO	4 CIL. 1.6 L	2003 - 2009
RENAULT	KANGOO EXPRES:	4 CIL. 1.6 L	2005 - 2009

**T38484**



RENAULT	CLIO	4 CIL. 1.6 L	2003 - 2009
---------	------	--------------	-------------

RENAULT	KANGOO	4 CIL. 1.6 L	2003 - 2010
NISSAN	APRIO	4 CIL. 1.6 L	2008 - 2010
RENAULT	KANGOO EXPRES	4 CIL. 1.6 L	2005 - 2009
NISSAN	PLATINA	4 CIL. 1.6 L	2002 - 2010

PLYMOUTH	CARAVELLE	4 CIL. 2.2 L	1988 - 1985
PLYMOUTH	HORIZON	4 CIL. 2.2 L	1988 - 1981
PLYMOUTH	RELIANT	4 CIL. 2.2 L	1988 - 1981
PLYMOUTH	SUNDANCE	4 CIL. 2.2 L	1988 - 1987
PLYMOUTH	VOYAGER	4 CIL. 2.2 L	1987 - 1984
PLYMOUTH	CARAVELLE	4 CIL. 2.2 L (Canada)	1984 - 1983

**T39074**



MAZDA	CX-7	4 CIL. 2.3 L	2006 - 2008
-------	------	--------------	-------------

**T41000**



**T41001**

Tipo de Resorte - Plastic Lisa/Posterior (72mm x 11mm x 24mm) -



DODGE	DAKOTA	4 CIL. 2.2 L	1988 - 1987
CHRYSLER	DAYTONA	4 CIL. 2.2 L (Canada)	1988 - 1985
DODGE	CARAVAN	4 CIL. 2.2 L	1987 - 1984
DODGE	GRAND CARAVAN	4 CIL. 2.2 L	1987 - 1987
CHRYSLER	E CLASS	4 CIL. 2.2 L	1984 - 1983
CHRYSLER	EXECUTIVE	4 CIL. 2.2 L (Canada)	1986 - 1986
DODGE	MINI RAM VAN	4 CIL. 2.2 L	1987 - 1984
CHRYSLER	NEW YORKER	4 CIL. 2.2 L	1988 - 1983
DODGE	EXPO	4 CIL. 2.2 L (Canada)	1988 - 1987
CHRYSLER	TOWN & COUNTRY	4 CIL. 2.2 L	1988 - 1982
DODGE	400	4 CIL. 2.2 L	1983 - 1982
DODGE	600	4 CIL. 2.2 L	1988 - 1983
CHRYSLER	LASER	4 CIL. 2.2 L	1986 - 1984
DODGE	CHARGER	4 CIL. 2.2 L	1987 - 1983
CHRYSLER	LEBARON	4 CIL. 2.2 L	1988 - 1982
DODGE	SHADOW	4 CIL. 2.2 L	1988 - 1987
DODGE	OMNI	4 CIL. 2.2 L	1988 - 1981
DODGE	LANCER	4 CIL. 2.2 L	1988 - 1985

DODGE	SHADOW	4 CIL. 2.2 L	1993 - 1992
DODGE	DAKOTA	4 CIL. 2.5 L	1994 - 1992
DODGE	SHADOW	4 CIL. 2.2 L	1994 - 1994
DODGE	CARAVAN	4 CIL. 2.5 L	1995 - 1995
DODGE	SHADOW	4 CIL. 2.5 L	1993 - 1992
DODGE	SPIRIT	4 CIL. 2.5 L	1994 - 1994
DODGE	SPIRIT	4 CIL. 2.5 L	1993 - 1992
DODGE	CARAVAN	4 CIL. 2.5 L	1994 - 1992
DODGE	SHADOW	4 CIL. 2.5 L	1994 - 1994
CHRYSLER	DAYTONA	4 CIL. 2.2 L (Canada)	1992 - 1992
CHRYSLER	DAYTONA	4 CIL. 2.5 L (Canada)	1993 - 1992
CHRYSLER	DAYTONA	4 CIL. 2.2 L	1992 - 1992
CHRYSLER	LEBARON	4 CIL. 2.5 L	1993 - 1994

**T41002**

Acero Lisa/Posterior (62mm x 10mm x 35mm)



DODGE	INTREPID	V6, 3.5 L	1995 - 1997
CHRYSLER	NEW YORKER	V6, 3.5 L	1995 - 1996
CHRYSLER	CONCORDE	V6, 3.5 L	1995 - 1997
DODGE	NEON	4 CIL. 2.0 L	1995 - 2002



DODGE	STRATUS	4 CIL. 2.0 L	1995	-	2000
CHRYSLER	CIRRUS	4 CIL. 2.0 L	2000	-	2000

**T41003**



DAIHATSU	CHARADE	3 CIL. 1.0 L	1992	-	1988
----------	---------	--------------	------	---	------

**T41004**



DAIHATSU	ROCKY	4 CIL. 1.6 L	1992	-	1990
----------	-------	--------------	------	---	------

DAIHATSU	CHARADE	4 CIL. 1.3 L	1992	-	1989
----------	---------	--------------	------	---	------

**T41005**

Tipo de Resorte - Acero Cog (47mm x N/A x 30mm)



FORD	RANGER	4 CIL. 2.3 L	2001	-	2001
------	--------	--------------	------	---	------

FORD	RANGER	4 CIL. 2.5 L	1998	-	2001
------	--------	--------------	------	---	------

**T41006**



FORD	ESCORT	4 CIL. 1.9 L	1991	-	1985
------	--------	--------------	------	---	------

FORD	ESCORT	4 CIL. 1.6 L	1985	-	1981
------	--------	--------------	------	---	------

MERCURY	TRACER	4 CIL. 1.9 L	1991	-	1991
---------	--------	--------------	------	---	------

**T41007**

Tipo de Resorte - Acero Lisa/Posterior (48mm x 9mm x 32mm) - c/Tornillo, Rondana, Rondana de Seguridad, Tuerca



FORD	ESCORT	4 CIL. 1.9 L	1996	-	1996
------	--------	--------------	------	---	------

**T41008**

Tipo de Resorte - Plastic Lisa/Posterior (85mm x Slotted x 30mm)



FORD	CONTOUR	4 CIL. 2.0 L	1997	-	1997
------	---------	--------------	------	---	------

FORD	CONTOUR	4 CIL. 2.0 L	1995	-	1995
------	---------	--------------	------	---	------

MERCURY	MYSTIQUE	4 CIL. 2.0 L	1995	-	1997
---------	----------	--------------	------	---	------

**T41009**



CHEVROLET	SPRINT	3 CIL. 1.0 L (Canada)	1991	-	1989
-----------	--------	-----------------------	------	---	------

GEO	METRO	3 CIL. 1.0 L	1995	-	1992
-----	-------	--------------	------	---	------

SUZUKI	SWIFT	3 CIL. 1.0 L (Canada)	1993	-	1992
--------	-------	-----------------------	------	---	------

PONTIAC	FIREFLY	3 CIL. 1.0 L (Canada)	1991	-	1989
---------	---------	-----------------------	------	---	------

**T41010**



GEO	METRO	3 CIL. 1.0 L	1997 - 1996
CHEVROLET	METRO	3 CIL. 1.0 L	2000 - 1998
PONTIAC	FIREFLY	3 CIL. 1.0 L (Canada)	2000 - 1996

HONDA	ACCORD	4 CIL. 2.3 L	1998 - 2002
-------	--------	--------------	-------------

**T41014**

Tipo de Resorte - Acero Lisa/Posterior (62mm x Slotted x 27mm)



**T41011**



HONDA	CIVIC	4 CIL. 1.5 L	1994 - 1992
HONDA	CIVIC	4 CIL. 1.6 L	1992 - 1992
HONDA	CIVIC	4 CIL. 1.5 L	1995 - 1995

ACURA	CL	4 CIL. 2.2 L	1997 - 1997
HONDA	ACCORD	4 CIL. 2.2 L	1994 - 1992
HONDA	ACCORD	4 CIL. 2.3 L	1998 - 2002
ACURA	CL	4 CIL. 2.3 L	1999 - 1999
HONDA	PRELUDE	4 CIL. 2.3 L	1996 - 1992
HONDA	PRELUDE	4 CIL. 2.2 L	1996 - 1992

**T41015**



**T41012**



HONDA	ACCORD	4 CIL. 2.0 L	1989 - 1986
HONDA	ACCORD	4 CIL. 1.8 L	1985 - 1984
HONDA	PRELUDE	4 CIL. 2.0 L	1987 - 1985
HONDA	ACCORD	4 CIL. 1.6 L (Canada)	1985 - 1984
HONDA	PRELUDE	4 CIL. 1.8 L	1987 - 1983

HONDA	ACCORD	V6, 2.7 L	1997 - 1997
HONDA	ACCORD	V6, 2.7 L	1997 - 1995

**T41016**

Tipo de Resorte - Acero Lisa/Posterior (55mm x Slotted x 30mm)



**T41013**

Tipo de Resorte - Acero Lisa/Posterior (70mm x Slotted x 19mm)



HONDA	ACCORD	4 CIL. 2.2 L	1994 - 1992
HONDA	PRELUDE	4 CIL. 2.2 L	1996 - 1992
ACURA	CL	4 CIL. 2.2 L	1997 - 1997
ACURA	CL	4 CIL. 2.3 L	1999 - 1999
HONDA	PRELUDE	4 CIL. 2.3 L	1996 - 1992

ACURA	INTEGRA	4 CIL. 1.8 L	2001 - 2001
ACURA	INTEGRA	4 CIL. 1.7 L	1993 - 1992
HONDA	CR-V	4 CIL. 2.0 L	1999 - 2001
ACURA	INTEGRA	4 CIL. 1.8 L	1998 - 1992
HONDA	CIVIC	4 CIL. 1.6 L	1999 - 2000

**T41017**



HONDA	CIVIC	4 CIL. 1.5 L	1987 - 1984
HONDA	CIVIC	4 CIL. 1.3 L	1987 - 1984

**T41018**



ACURA	INTEGRA	4 CIL. 1.6 L	1989 - 1986
-------	---------	--------------	-------------

**T41019**



HONDA	PRELUDE	4 CIL. 2.1 L	1991 - 1990
HONDA	PRELUDE	4 CIL. 2.0 L	1991 - 1988

**T41020**



ACURA	TL	5 CIL. 2.5 L	1998 - 1998
ACURA	TL	5 CIL. 2.5 L	1997 - 1995

**T41021**



ACURA	TL	V6, 3.2 L	1998 - 1998
ACURA	TL	V6, 3.2 L	1998 - 1996
ACURA	LEGEND	V6, 3.2 L	1995 - 1992

**T41022**



HONDA	PRELUDE	4 CIL. 2.2 L	2001 - 2001
HONDA	PRELUDE	4 CIL. 2.2 L	2000 - 1993

**T41023**

Tipo de Resorte - Acero Lisa/Posterior (53mm x Slotted x 26mm)



HONDA	CIVIC	4 CIL. 1.6 L	2000 - 2000
-------	-------	--------------	-------------

**T41024**



HONDA	PRELUDE	4 CIL. 2.2 L	2000 - 1993
HONDA	PRELUDE	4 CIL. 2.2 L	2001 - 2001

**T41025**



ISUZU	TROOPER II	4 CIL. 2.3 L	1987 - 1986
ISUZU	PICKUP	4 CIL. 2.3 L	1995 - 1992
ISUZU	AMIGO	4 CIL. 2.3 L	1993 - 1992
ISUZU	IMPULSE	4 CIL. 2.3 L	1989 - 1988
ISUZU	IMPULSE	4 CIL. 2.0 L	1989 - 1985

GEO	STORM	4 CIL. 1.6 L	1991 - 1990
ISUZU	IMPULSE	4 CIL. 1.8 L	1992 - 1992

**T41028**



ISUZU	AMIGO	V6, 3.2 L	2000 - 1998
ACURA	SLX	V6, 3.5 L	1999 - 1998
ISUZU	TROOPER	V6, 3.5 L	2002 - 1998
ACURA	SLX	V6, 3.5 L	1999 - 1999
ACURA	SLX	V6, 3.2 L	1997 - 1996
HONDA	PASSPORT	V6, 3.2 L	2002 - 1994
ISUZU	TROOPER	V6, 3.2 L	1997 - 1992
ISUZU	RODEO	V6, 3.5 L	2004 - 2004
ISUZU	RODEO	V6, 3.2 L	2004 - 1993

**T41026**



HONDA	PASSPORT	4 CIL. 2.6 L	1996 - 1994
ISUZU	TROOPER	4 CIL. 2.6 L	1991 - 1990
ISUZU	AMIGO	4 CIL. 2.6 L	1994 - 1992
ISUZU	TROOPER II	4 CIL. 2.6 L	1989 - 1988
ISUZU	PICKUP	4 CIL. 2.6 L	1995 - 1992
ISUZU	RODEO	4 CIL. 2.6 L	1997 - 1992

**T41029**



KIA	SPORTAGE	4 CIL. 2.0 L	2002 - 1995
FORD	PROBE	4 CIL. 2.2 L	1992 - 1992
MAZDA	B2200 PICKUP	4 CIL. 2.2 L	1993 - 1992
MAZDA	626	4 CIL. 2.2 L	1992 - 1988
MAZDA	MX-6	4 CIL. 2.2 L	1992 - 1988

**T41027**



ISUZU	I-MARK	4 CIL. 1.6 L (Canada)	1990 - 1990
ISUZU	STYLUS	4 CIL. 1.8 L	1992 - 1992
ISUZU	STYLUS	4 CIL. 1.6 L	1991 - 1991
ISUZU	IMPULSE	4 CIL. 1.6 L	1992 - 1990
ISUZU	I-MARK	4 CIL. 1.6 L	1989 - 1989

**T41030**



FORD	FESTIVA	4 CIL. 1.3 L	1993	-	1992
KIA	SEPHIA	4 CIL. 1.6 L	1995	-	1994
FORD	ASPIRE	4 CIL. 1.3 L	1997	-	1994
MERCURY	TRACER	4 CIL. 1.6 L	1989	-	1988
MAZDA	323	4 CIL. 1.6 L	1994	-	1987
MERCURY	TRACER	4 CIL. 1.6 L (Canada)	1990	-	1987
MAZDA	MX-3	4 CIL. 1.6 L	1993	-	1992
MAZDA	323	4 CIL. 1.8 L (Canada)	1991	-	1990
MAZDA	PROTEGE	4 CIL. 1.8 L	1995	-	1990

**T41031**

Tipo de Resorte - Acero Lisa/Posterior (52mm x Slotted x 25mm)



FORD	ESCORT	4 CIL. 1.8 L	1996	-	1996
------	--------	--------------	------	---	------

**T41032**



KIA	SPECTRA	4 CIL. 1.8 L	2004	-	2000
KIA	SEPHIA	4 CIL. 1.8 L	2001	-	1998

**T41033**



MAZDA	929	V6, 3.0 L	1991	-	1988
MAZDA	MPV	V6, 3.0 L	1998	-	1992

**T41034**



FORD	PROBE	V6, 2.5 L	1997	-	1993
MAZDA	MILLENNIA	V6, 2.5 L	2002	-	1995
MAZDA	MX-3	V6, 1.8 L	1994	-	1992
MAZDA	626	V6, 2.5 L	2002	-	1993
MAZDA	MX-3	V6, 1.8 L (Canada)	1995	-	1995
MAZDA	MX-6	V6, 2.5 L	1997	-	1993

**T41035**



MAZDA	626	4 CIL. 2.0 L	1987	-	1986
MAZDA	B2000 PICKUP	4 CIL. 2.0 L	1987	-	1987

**T41036**



MAZDA	929	V6, 3.0 L	1995	-	1990
-------	-----	-----------	------	---	------

**T41037**

Tipo de Resorte - Acero Lisa/Posterior (60mm x N/A x 28.5mm) -



HYUNDAI	ATTITUDE	4 CIL. 1.4 L	2008	-	2010
HYUNDAI	ATTITUDE	4 CIL. 1.6 L	2006	-	2007
HYUNDAI	ACCENT	4 CIL. 1.5 L	2003	-	2003
HYUNDAI	VERNA	4 CIL. 1.5 L	2004	-	2006
HYUNDAI	VERNA	4 CIL. 1.6 L	2005	-	2006
HYUNDAI	ATTITUDE	4 CIL. 1.6 L	2008	-	2010

MITSUBISHI	ECLIPSE	V6, 3.0 L	2004	-	2005
MITSUBISHI	ECLIPSE	V6, 3.8 L	2007	-	2008
MITSUBISHI	GALANT	V6, 3.8 L	2004	-	2005
MITSUBISHI	ENDEAVOR	V6, 3.8 L	2004	-	2007

**T41040**



**T41038**

Tipo de Resorte - Acero Lisa/Posterior (55mm x 8.5mm x 18.5mm) -



CHRYSLER	SEBRING	4 CIL. 2.4 L	2004	-	2004
DODGE	STRATUS	4 CIL. 2.4 L	2001	-	2004
MITSUBISHI	LANCER	4 CIL. 2.0 L	2004	-	2005
MITSUBISHI	OUTLANDER	4 CIL. 2.4 L	2005	-	2006
MITSUBISHI	GALANT	4 CIL. 2.4 L	2004	-	2005
MITSUBISHI	GALANT	4 CIL. 2.4 L	2006	-	2007
MITSUBISHI	OUTLANDER	4 CIL. 2.4 L	2004	-	2004
MITSUBISHI	LANCER	4 CIL. 2.4 L	2004	-	2005
MITSUBISHI	LANCER	4 CIL. 2.0 L	2006	-	2006

HYUNDAI	SANTA FE	V6, 2.7 L	2006	-	2001
HYUNDAI	TIBURON	V6, 2.7 L	2006	-	2003
HYUNDAI	TUCSON	V6, 2.7 L	2006	-	2005
KIA	OPTIMA	V6, 2.7 L	2006	-	2002
KIA	OPTIMA	V6, 2.5 L	2001	-	2001
KIA	MAGENTIS	V6, 2.5 L (Canada)	2001	-	2001
KIA	SPORTAGE	V6, 2.7 L	2007	-	2005
KIA	MAGENTIS	V6, 2.7 L (Canada)	2006	-	2002
HYUNDAI	SONATA	V6, 2.7 L	2005	-	2002
HYUNDAI	SONATA	V6, 2.5 L	2001	-	1999

**T41041**



**T41039**

Acero Lisa/Posterior (60mm x 10mm x 35mm)



DODGE	STRATUS	V6, 2.5 L	1995	-	2000
CHRYSLER	SEBRING	V6, 3.0 L	2001	-	2005
CHRYSLER	CIRRUS	V6, 2.5 L	2000	-	2000
CHRYSLER	SEBRING	V6, 2.5 L	1996	-	2000
DODGE	STRATUS	V6, 3.0 L	2001	-	2003
MITSUBISHI	MONTERO	V6, 3.8 L	2004	-	2005
MITSUBISHI	MONTERO	V6, 3.8 L	2006	-	2007
MITSUBISHI	MONTERO SPORT	V6, 3.5 L	2004	-	2004

HYUNDAI	TUCSON	4 CIL. 2.0 L	2006	-	2005
KIA	SPORTAGE	4 CIL. 2.0 L	2006	-	2005
HYUNDAI	TIBURON	4 CIL. 2.0 L	2006	-	1997
HYUNDAI	ELANTRA	4 CIL. 1.8 L	1998	-	1996
HYUNDAI	ELANTRA	4 CIL. 2.0 L	2006	-	1999
HYUNDAI	TIBURON	4 CIL. 1.8 L	1998	-	1997
KIA	SPECTRA	4 CIL. 2.0 L	2007	-	2004

**T41042**



EAGLE	VISTA	4 CIL. 1.5 L (Canada)	1991	-	1989
HYUNDAI	EXCEL	4 CIL. 1.5 L	1994	-	1990
HYUNDAI	SCOUPE	4 CIL. 1.5 L	1993	-	1991
DODGE	COLT	4 CIL. 1.4 L	1984	-	1982
DODGE	COLT	4 CIL. 1.5 L	1991	-	1985
EAGLE	SUMMIT	4 CIL. 1.5 L	1990	-	1989
PLYMOUTH	COLT	4 CIL. 1.4 L	1984	-	1983
PLYMOUTH	COLT	4 CIL. 1.5 L	1991	-	1985
MITSUBISHI	MIRAGE	4 CIL. 1.5 L	1990	-	1987
MITSUBISHI	PRECIS	4 CIL. 1.5 L	1994	-	1990

**T41043**



DODGE	RAM 50 PICKUP	4 CIL. 2.0 L	1989	-	1987
DODGE	RAM 50 PICKUP	4 CIL. 2.4 L	1993	-	1992
EAGLE	2000 GTX	4 CIL. 2.0 L (Canada)	1992	-	1991
DODGE	2000 GTX	4 CIL. 2.0 L (Canada)	1990	-	1989
DODGE	COLT	4 CIL. 2.0 L	1986	-	1985
MITSUBISHI	GALANT	4 CIL. 2.4 L	1987	-	1985
PLYMOUTH	COLT	4 CIL. 2.0 L	1986	-	1986
MITSUBISHI	PICKUP	4 CIL. 2.0 L	1989	-	1987
MITSUBISHI	PICKUP	4 CIL. 2.4 L	1996	-	1992
MITSUBISHI	VAN	4 CIL. 2.4 L	1990	-	1987
MITSUBISHI	GALANT	4 CIL. 2.0 L	1992	-	1992

**T41044**

Tipo de Resorte - Acero Lisa/Posterior (60mm x N/A x 29mm) -



HYUNDAI	H100	4 CIL. 2.4 L	2005	-	2005
---------	------	--------------	------	---	------

**T41045**



DODGE	RAM 50 PICKUP	4 CIL. 2.0 L	1989	-	1987
DODGE	RAM 50 PICKUP	4 CIL. 2.4 L	1992	-	1992
MITSUBISHI	PICKUP	4 CIL. 2.4 L	1992	-	1992
PLYMOUTH	COLT	4 CIL. 2.0 L	1989	-	1987
MITSUBISHI	PICKUP	4 CIL. 2.0 L	1989	-	1987
MITSUBISHI	VAN	4 CIL. 2.4 L	1990	-	1987

**T41046**



EAGLE	2000 GTX	4 CIL. 2.0 L (Canada)	1992	-	1991
HYUNDAI	ELANTRA	4 CIL. 1.8 L	1995	-	1993
DODGE	2000 GTX	4 CIL. 2.0 L (Canada)	1989	-	1989
EAGLE	TALON	4 CIL. 2.0 L	1994	-	1990
HYUNDAI	SONATA	4 CIL. 2.0 L	1998	-	1992
HYUNDAI	ELANTRA	4 CIL. 1.6 L	1995	-	1992
DODGE	COLT	4 CIL. 1.6 L	1990	-	1989
MITSUBISHI	ECLIPSE	4 CIL. 2.0 L	1994	-	1992
MITSUBISHI	MIRAGE	4 CIL. 1.6 L	1992	-	1989

MITSUBISHI	GALANT	4 CIL. 2.0 L	1992 - 1992
PLYMOUTH	COLT	4 CIL. 1.6 L	1990 - 1989
PLYMOUTH	LASER	4 CIL. 2.0 L	1994 - 1990

**T41047**



HYUNDAI	ELANTRA	4 CIL. 1.6 L	1995 - 1992
DODGE	RAM 50 PICKUP	4 CIL. 2.4 L	1993 - 1993
EAGLE	2000 GTX	4 CIL. 2.0 L (Canada)	1992 - 1991
EAGLE	SUMMIT	4 CIL. 2.4 L	1996 - 1993
HYUNDAI	ELANTRA	4 CIL. 1.8 L	1995 - 1993
DODGE	2000 GTX	4 CIL. 2.0 L (Canada)	1989 - 1989
EAGLE	TALON	4 CIL. 2.0 L	1995 - 1990
HYUNDAI	SONATA	4 CIL. 2.0 L	1998 - 1992
PLYMOUTH	COLT	4 CIL. 2.4 L	1994 - 1993
PLYMOUTH	LASER	4 CIL. 2.0 L	1994 - 1990
MITSUBISHI	GALANT	4 CIL. 2.4 L	1995 - 1994
MITSUBISHI	PICKUP	4 CIL. 2.4 L	1996 - 1993
MITSUBISHI	GALANT	4 CIL. 2.0 L	1993 - 1992
MITSUBISHI	ECLIPSE	4 CIL. 2.0 L	1994 - 1992

**T41048**

Tipo de Resorte - Acero Lisa/Posterior (60mm x Slotted x 32mm)



DODGE	SHADOW	V6, 3.0 L	1994 - 1992
DODGE	SPIRIT	V6, 3.0 L	1994 - 1994
DODGE	GRAND CARAVAN	V6, 3.0 L	2000 - 1992
DODGE	SPIRIT	V6, 3.0 L	1995 - 1992
DODGE	CARAVAN	V6, 3.0 L	1995 - 1995
DODGE	CARAVAN	V6, 3.0 L	2000 - 1992

DODGE	STEALTH	V6, 3.0 L	1996 - 1992
CHRYSLER	VOYAGER	V6, 3.0 L	2000 - 2000
CHRYSLER	DAYTONA	V6, 3.0 L (Canada)	1993 - 1992
CHRYSLER	VOYAGER	V6, 3.0 L	2000 - 2000
CHRYSLER	LEBARON	V6, 3.0 L	1995 - 1992
CHRYSLER	LEBARON	V6, 3.0 L	1993 - 1995
CHRYSLER	GRAND VOYAGER	V6, 3.0 L	2000 - 2000
MITSUBISHI	PICKUP	V6, 3.0 L	1994 - 1992
MITSUBISHI	MONTERO	V6, 3.0 L	1994 - 1992
MITSUBISHI	3000GT	V6, 3.0 L	1999 - 1997

**T41049**



DODGE	RAM 50 PICKUP	4 CIL. 2.3 L Diesel	1985 - 1983
MITSUBISHI	PICKUP	4 CIL. 2.3 L Diesel	1985 - 1983

**T41050**



DODGE	RAM 50 PICKUP	4 CIL. 2.3 L Diesel	1985 - 1983
MITSUBISHI	PICKUP	4 CIL. 2.3 L Diesel	1985 - 1983

**T41051**



HYUNDAI	ACCENT	4 CIL. 1.5 L	1999 - 1995
HYUNDAI	SCOUPE	4 CIL. 1.5 L	1995 - 1994



EAGLE	VISTA	4 CIL. 1.5 L (Canada)	1992	-	1992
DODGE	COLT	4 CIL. 1.5 L	1994	-	1992
DODGE	COLT	4 CIL. 1.5 L (Canada)	1995	-	1995
EAGLE	SUMMIT	4 CIL. 1.5 L	1996	-	1991
PLYMOUTH	COLT	4 CIL. 1.5 L	1994	-	1991
MITSUBISHI	MIRAGE	4 CIL. 1.5 L	1996	-	1991
PLYMOUTH	COLT	4 CIL. 1.5 L (Canada)	1995	-	1995

**T41052**



DODGE	COLT	4 CIL. 1.8 L	1994	-	1993
EAGLE	SUMMIT	4 CIL. 1.8 L	1996	-	1992
PLYMOUTH	COLT	4 CIL. 1.8 L	1994	-	1992
MITSUBISHI	MIRAGE	4 CIL. 1.8 L	1996	-	1993

**T41053**



HYUNDAI	SONATA	4 CIL. 2.4 L	1991	-	1989
EAGLE	SUMMIT	4 CIL. 2.4 L	1992	-	1992
DODGE	COLT	4 CIL. 2.0 L	1986	-	1985
DODGE	RAM 50 PICKUP	4 CIL. 2.0 L	1987	-	1987
EAGLE	2000 GTX	4 CIL. 2.0 L (Canada)	1992	-	1991
DODGE	2000 GTX	4 CIL. 2.0 L (Canada)	1990	-	1989
MITSUBISHI	VAN	4 CIL. 2.4 L	1987	-	1987
MITSUBISHI	GALANT	4 CIL. 2.0 L	1992	-	1992
PLYMOUTH	COLT	4 CIL. 2.4 L	1992	-	1992
MITSUBISHI	PICKUP	4 CIL. 2.0 L	1987	-	1987
MITSUBISHI	GALANT	4 CIL. 2.4 L	1987	-	1985
PLYMOUTH	COLT	4 CIL. 2.0 L	1986	-	1986

**T41054**

Tipo de Resorte - Acero Lisa/Posterior (60mm x 10mm x 33mm) -



CHRYSLER	SEBRING	4 CIL. 2.4 L	2004	-	2004
DODGE	STRATUS	4 CIL. 2.4 L	2001	-	2004

**T41055**



DODGE	COLT	4 CIL. 1.6 L	1987	-	1982
PLYMOUTH	COLT	4 CIL. 1.6 L	1987	-	1983
MITSUBISHI	MIRAGE	4 CIL. 1.6 L	1987	-	1985

**T41056**



EAGLE	TALON	4 CIL. 1.8 L	1994	-	1993
DODGE	COLT	4 CIL. 1.6 L	1990	-	1987
DODGE	COLT	4 CIL. 1.8 L	1990	-	1989
PLYMOUTH	COLT	4 CIL. 1.6 L	1990	-	1987
MITSUBISHI	MIRAGE	4 CIL. 1.6 L	1988	-	1987
MITSUBISHI	ECLIPSE	4 CIL. 1.8 L	1994	-	1992
PLYMOUTH	LASER	4 CIL. 1.8 L	1994	-	1990
PLYMOUTH	COLT	4 CIL. 1.8 L	1990	-	1989

**T41057**



EAGLE	TALON	4 CIL. 1.8 L	1994 - 1993
MITSUBISHI	ECLIPSE	4 CIL. 1.8 L	1994 - 1992
PLYMOUTH	LASER	4 CIL. 1.8 L	1994 - 1990

**T41060**



SUBARU	JUSTY	3 CIL. 1.2 L (Canada)	1995 - 1995
SUBARU	JUSTY	3 CIL. 1.2 L	1994 - 1987

**T41058**



NISSAN	TSURU	4 CIL. 1.6 L	1984 - 1994
--------	-------	--------------	-------------

**T41059**

Tipo de Resorte - Acero Lisa/Posterior (60mm x 10mm x 30mm)



NISSAN	PATHFINDER	V6, 3.3 L	1997 - 2000
NISSAN	FRONTIER	V6, 3.3 L	2004 - 2004
NISSAN	QUEST	V6, 3.0 L	1997 - 1998
NISSAN	QUEST	V6, 3.3 L	1999 - 2001
NISSAN	PATHFINDER	V6, 3.0 L	1995 - 1995
NISSAN	FRONTIER	V6, 3.3 L	2003 - 2003
NISSAN	XTERRA	V6, 3.3 L	2000 - 2002
NISSAN	MAXIMA	V6, 3.0 L	1993 - 1994

**T41061**



SUBARU	DL	4 CIL. 1.8 L	1989 - 1985
SUBARU	LOYALE	4 CIL. 1.8 L	1994 - 1990
SUBARU	GL	4 CIL. 1.8 L	1989 - 1985
SUBARU	RX	4 CIL. 1.8 L	1989 - 1985
SUBARU	GL-10	4 CIL. 1.8 L	1989 - 1985
SUBARU	XT	4 CIL. 1.8 L	1991 - 1985

**T41062**



SUBARU	XT	4 CIL. 1.8 L	1991 - 1985
SUBARU	LOYALE	4 CIL. 1.8 L	1994 - 1990
SUBARU	GL-10	4 CIL. 1.8 L	1989 - 1985
SUBARU	RX	4 CIL. 1.8 L	1989 - 1985
SUBARU	DL	4 CIL. 1.8 L	1989 - 1985
SUBARU	GL	4 CIL. 1.8 L	1989 - 1985

**T41063**



SUBARU	IMPENZA	4 CIL. 1.8 L	1997 - 1993
SUBARU	LEGACY	4 CIL. 2.2 L	1996 - 1992
SUBARU	IMPENZA	4 CIL. 2.2 L	1996 - 1995

**T41066**



GEO	PRIZM	4 CIL. 1.6 L	1992 - 1992
CHEVROLET	NOVA	4 CIL. 1.6 L	1988 - 1985
TOYOTA	TERCEL	4 CIL. 1.5 L	1988 - 1981
TOYOTA	CELICA	4 CIL. 1.6 L	1993 - 1992
TOYOTA	COROLLA	4 CIL. 1.6 L	1992 - 1992

**T41064**



CHEVROLET	TRACKER	4 CIL. 1.6 L (Canada)	1992 - 1992
GEO	TRACKER	4 CIL. 1.6 L	1995 - 1992
CHEVROLET	TRACKER	4 CIL. 1.6 L	1992 - 1992
SUZUKI	SIDEKICK	4 CIL. 1.6 L	1995 - 1992

**T41067**

Tipo de Resorte - Acero Lisa/Posterior (57.5mm x Slotted x 29mm)



TOYOTA	CAMRY	4 CIL. 2.2 L	2001 - 2001
--------	-------	--------------	-------------

**T41065**

Tipo de Resorte - Acero Lisa/Posterior (51mm x 8mm x 28mm)



CHEVROLET	TRACKER	4 CIL. 1.6 L	2002 - 2000
GEO	METRO	4 CIL. 1.3 L	1997 - 1995
GEO	TRACKER	4 CIL. 1.6 L	1997 - 1994
CHEVROLET	TRACKER	4 CIL. 1.6 L (Canada)	2002 - 2001
SUZUKI	SIDEKICK	4 CIL. 1.6 L	1998 - 1992
SUZUKI	VITARA	4 CIL. 1.6 L	2001 - 1999
SUZUKI	VITARA	4 CIL. 1.6 L (Canada)	2002 - 2002
SUZUKI	X-90	4 CIL. 1.6 L	1998 - 1996

**T41068**



TOYOTA	PICKUP	4 CIL. 2.4 L Diesel (Canar1987	- 1987
TOYOTA	PICKUP	4 CIL. 2.2 L Diesel	1983 - 1981
TOYOTA	PICKUP	4 CIL. 2.4 L Diesel	1986 - 1984

**T41069**



TOYOTA	SUPRA	6 CIL. 2.8 L	1986	-	1986
TOYOTA	CELICA	6 CIL. 2.8 L	1985	-	1982
TOYOTA	CRESSIDA	6 CIL. 2.8 L	1988	-	1983

**T41070**



TOYOTA	CELICA	4 CIL. 2.0 L	1986	-	1986
TOYOTA	CAMRY	4 CIL. 2.0 L	1986	-	1983

**T41071**



TOYOTA	PASEO	4 CIL. 1.5 L	1997	-	1992
TOYOTA	TERCEL	4 CIL. 1.5 L	1998	-	1995
TOYOTA	PASEO	4 CIL. 1.5 L (Canada)	1999	-	1998
TOYOTA	TERCEL	4 CIL. 1.5 L (Canada)	1999	-	1999

**T41072**



GEO	PRIZM	4 CIL. 1.8 L	1997	-	1993
GEO	PRIZM	4 CIL. 1.6 L	1997	-	1993
TOYOTA	COROLLA	4 CIL. 1.6 L	1997	-	1993
TOYOTA	CELICA	4 CIL. 1.8 L	1997	-	1994
TOYOTA	COROLLA	4 CIL. 1.8 L	1997	-	1993

**T41073**



TOYOTA	PICKUP	V6, 3.0 L	1992	-	1992
TOYOTA	4 RUNNER	V6, 3.0 L	1992	-	1992

**T41074**



TOYOTA	COROLLA	4 CIL. 1.6 L	1989	-	1985
TOYOTA	MR2	4 CIL. 1.6 L	1989	-	1985

**T41075**

Tipo de Resorte - Acero Lisa/Posterior (62mm x 8.1mm x 36.5mm)



TOYOTA	SIENNA	V6, 3.0 L	2003	-	1998
TOYOTA	CAMRY	V6, 3.0 L	2001	-	1992
TOYOTA	SIENNA	V6, 3.0 L	2000	-	2003
TOYOTA	CAMRY	V6, 3.0 L	2001	-	2001
TOYOTA	SOLARA	V6, 3.0 L	2003	-	2001
TOYOTA	AVALON	V6, 3.0 L	2004	-	2004
TOYOTA	CAMRY SOLARA	V6, 3.0 L	2000	-	1999

**T41076**



TOYOTA	TERCEL	4 CIL. 1.5 L	1994	-	1992
--------	--------	--------------	------	---	------

**T41077**



TOYOTA	CAMRY	4 CIL. 1.8 L Diesel	1985	-	1984
TOYOTA	CAMRY	4 CIL. 2.0 L Diesel	1986	-	1986
TOYOTA	COROLLA	4 CIL. 1.8 L Diesel	1985	-	1984

**T41078**

Acero Lisa/Posterior (62mm x 8.1mm x 36.5mm) - c/Bracket



TOYOTA	LAND CRUISER	V8, 4.7 L	2003	-	2006
TOYOTA	TUNDRA	V8, 4.7 L	2007	-	2008
TOYOTA	SEQUOIA	V8, 4.7 L	2007	-	2008
TOYOTA	4 RUNNER	V8, 4.7 L	2007	-	2007

**T41079**

Tipo de Resorte - Acero Lisa/Posterior (72mm x 10.3mm x 25.4mm) -



VOLKSWAGEN	PASSAT	4 CIL. 2.0 L	1995	-	1996
------------	--------	--------------	------	---	------

VOLKSWAGEN	CABRIO	4 CIL. 2.0 L	2002	-	2002
VOLKSWAGEN	GOLF	4 CIL. 2.0 L	1995	-	2000
VOLKSWAGEN	DERBY	4 CIL. 1.8 L	2006	-	2008
VOLKSWAGEN	POINTER	4 CIL. 1.8 L	1998	-	2008
VOLKSWAGEN	DERBY	4 CIL. 1.8 L	2005	-	2005
VOLKSWAGEN	JETTA	4 CIL. 2.0 L	1995	-	2000

**T41080**



VOLKSWAGEN	GOLF	4 CIL. 1.6 L Diesel	1987	-	1985
VOLKSWAGEN	RABBIT	4 CIL. 1.6 L Diesel	1984	-	1981
VOLKSWAGEN	QUANTUM	4 CIL. 1.6 L Diesel	1985	-	1982
VOLKSWAGEN	GOLF	4 CIL. 1.6 L Diesel (Cana)	1992	-	1992
VOLKSWAGEN	VANAGON	4 CIL. 1.6 L Diesel	1983	-	1982
VOLKSWAGEN	RABBIT PICKUP	4 CIL. 1.6 L Diesel	1983	-	1981
VOLKSWAGEN	DASHER	4 CIL. 1.6 L Diesel	1981	-	1981
VOLKSWAGEN	JETTA	4 CIL. 1.6 L Diesel	1992	-	1992
VOLKSWAGEN	JETTA	4 CIL. 1.6 L Diesel (Cana)	1988	-	1987

**T41081**



VOLVO	940	4 CIL. 2.3 L	1995	-	1991
VOLVO	240	4 CIL. 2.3 L	1992	-	1983
VOLVO	240	4 CIL. 2.3 L (Canada)	1982	-	1982
VOLVO	780	4 CIL. 2.3 L	1991	-	1989
VOLVO	740	4 CIL. 2.3 L	1992	-	1985
VOLVO	240	4 CIL. 2.1 L	1985	-	1981
VOLVO	260	4 CIL. 2.1 L	1981	-	1981
VOLVO	760	4 CIL. 2.3 L	1990	-	1984

**T41082**



AUDI	A6	V6, 2.8 L	2001 - 1998
AUDI	A6	V6, 2.7 L	2004 - 2000
AUDI	A4	V6, 2.8 L	2001 - 1998
AUDI	S4	V6, 2.7 L	2002 - 2000
AUDI	ALLROAD QUATTR	V6, 2.7 L	2005 - 2001
VOLKSWAGEN	PASSAT	V6, 2.8 L	2005 - 1998

CHRYSLER	CONCORDE	V6, 3.5 L	1993 - 2002
CHRYSLER	NEW YORKER	V6, 3.5 L	1994 - 1994
CHRYSLER	300M	V6, 3.5 L	2002 - 2002

**T41085**

Acero Lisa/Posterior (60mm x 10mm x 36mm)



NISSAN	300ZX	V6, 3.0 L	1996 - 1996
--------	-------	-----------	-------------

**T41086**

Tipo Hidráulico - Acero Lisa/Posterior (65mm x 10mm x 33mm) - c/Buje, Tornillo, Rondana



AUDI	A4	V6, 3.0 L	2006 - 2006
AUDI	A6	V6, 3.0 L	2004 - 2002
AUDI	A4	V6, 3.0 L	2006 - 2002

**T41087**



HYUNDAI	SANTA FE	4 CIL. 2.4 L	2004 - 2001
HYUNDAI	SONATA	4 CIL. 2.4 L	2005 - 1999
KIA	OPTIMA	4 CIL. 2.4 L	2006 - 2001
KIA	MAGENTIS	4 CIL. 2.4 L (Canada)	2006 - 2001
HYUNDAI	SANTA FE	4 CIL. 2.4 L (Canada)	2005 - 2005

**T41083**



BMW	325	6 CIL. 2.7 L	1988 - 1986
BMW	528E	6 CIL. 2.7 L	1988 - 1982
BMW	525I	6 CIL. 2.5 L	1993 - 1989
BMW	325IS	6 CIL. 2.5 L	1993 - 1987
BMW	325E	6 CIL. 2.7 L	1987 - 1985
BMW	325IX	6 CIL. 2.5 L	1991 - 1988
BMW	325I	6 CIL. 2.5 L	1993 - 1987

**T41084**

Tipo de Resorte - Acero Lisa/Posterior (62mm x 10mm x 35mm) - c/Tornillo, Rondana



DODGE	INTREPID	V6, 3.5 L	2000 - 2002
DODGE	INTREPID	V6, 3.2 L	1998 - 2000
CHRYSLER	CONCORDE	V6, 3.2 L	1998 - 2000

**T41088**



NISSAN	200SX	4 CIL. 2.0 L	1988 - 1988
NISSAN	200SX	4 CIL. 1.8 L	1986 - 1984
NISSAN	200SX	4 CIL. 1.8 L (Canada)	1987 - 1987
NISSAN	STANZA	4 CIL. 2.0 L	1989 - 1982

**T41091**



FORD	PROBE	4 CIL. 2.0 L	1997 - 1993
MAZDA	626	4 CIL. 2.0 L	2002 - 1993
MAZDA	MX-6	4 CIL. 2.0 L	1997 - 1993
MAZDA	PROTEGE	4 CIL. 2.0 L	2003 - 2001

**T41089**



NISSAN	200SX	4 CIL. 2.0 L	1987 - 1984
--------	-------	--------------	-------------

**T41092**



SUBARU	LEGACY	4 CIL. 2.5 L	1996 - 1996
--------	--------	--------------	-------------

**T41090**

Tipo de Resorte - Acero Lisa/Posterior (55mm x 10.1mm x 30mm)



HONDA	PILOT	V6, 3.5 L	2004 - 2003
HONDA	ODYSSEY	V6, 3.5 L	2002 - 2002
ACURA	TL	V6, 3.2 L	2000 - 2000
ACURA	TL	V6, 3.2 L	2000 - 1999
HONDA	ACCORD	V6, 3.0 L	1998 - 2001
HONDA	ACCORD	V6, 3.0 L	2001 - 1998

**T41097**



AUDI	S8	V8, 4.2 L	2001 - 2001
AUDI	A6	V8, 4.2 L	2001 - 2000
AUDI	A8	V8, 4.2 L	2001 - 2000

**T41098**

Acero Lisa/Posterior (62mm x 10mm x 34mm) - c/Bracket, Tornillo, Buje, Rondana



VOLKSWAGEN	TOUAREG	V8, 4.2 L	2006 - 2006
------------	---------	-----------	-------------

**T41107**



VOLKSWAGEN	JETTA	4 CIL. 2.0 L	1992 - 1992
VOLKSWAGEN	PASSAT	4 CIL. 2.0 L	1992 - 1992
VOLKSWAGEN	GOLF	4 CIL. 2.0 L	1992 - 1992

PONTIAC	SUNBURST	4 CIL. 1.5 L (Canada)	1988 - 1985
---------	----------	-----------------------	-------------

**T41202**



ISUZU	STYLUS	4 CIL. 1.6 L	1993 - 1991
GEO	STORM	4 CIL. 1.6 L	1993 - 1990

**T41182**



TOYOTA	CELICA	4 CIL. 2.0 L	1993 - 1992
--------	--------	--------------	-------------

**T41203**



TOYOTA	4 RUNNER	V6, 3.0 L	1995 - 1992
TOYOTA	T100	V6, 3.0 L	1994 - 1993
TOYOTA	PICKUP	V6, 3.0 L	1995 - 1992

**T41187**



NISSAN	PULSAR NX	4 CIL. 1.8 L	1989 - 1988
NISSAN	PULSAR NX	4 CIL. 1.6 L	1987 - 1987

**T41204**

Acero Lisa/Posterior (62mm x 12mm x 40mm)



TOYOTA	4 RUNNER	V6, 3.4 L	2002 - 2002
--------	----------	-----------	-------------

**T41201**



ISUZU	I-MARK	4 CIL. 1.5 L (Canada)	1990 - 1990
CHEVROLET	SPECTRUM	4 CIL. 1.5 L	1988 - 1985
ISUZU	I-MARK	4 CIL. 1.5 L	1989 - 1985

**T41205**



FORD	TAURUS	V6, 3.0 L	1995 - 1992
------	--------	-----------	-------------



**T41209**



CHEVROLET	LUMINA	V6, 3.4 L	1997 - 1992
CHEVROLET	MONTE CARLO	V6, 3.4 L	1997 - 1995
OLDSMOBILE	CUTLASS SUPREM	V6, 3.4 L	1996 - 1992
PONTIAC	GRAND PRIX	V6, 3.4 L	1996 - 1992

**T41210**



MAZDA	MILLENNIA	V6, 2.3 L	2002 - 1995
-------	-----------	-----------	-------------

**T41211**



mitsubishi	MIRAGE	4 CIL. 1.5 L	1999 - 1997
------------	--------	--------------	-------------

**T41212**

Tipo de Resorte - Acero Lisa/Posterior (57.5mm x Slotted x 34mm)



MITSUBISHI	LANCER	4 CIL. 2.0 L	2005 - 2005
MITSUBISHI	LANCER	4 CIL. 2.0 L	2007 - 2008

**T41213**



SUBARU	SVX	6 CIL. 3.3 L	1997 - 1992
--------	-----	--------------	-------------

**T41219**



ACURA	RL	V6, 3.5 L	2004 - 1996
-------	----	-----------	-------------

**T41225**



SUBARU	IMPREZA	4 CIL. 2.0 L	2003 - 2002
--------	---------	--------------	-------------

**T41226**



SUBARU	FORESTER	4 CIL. 2.5 L	2007 - 1999
SUBARU	IMPREZA	4 CIL. 2.5 L	2007 - 1999
SUBARU	IMPREZA	4 CIL. 2.2 L	2001 - 1999
SUBARU	LEGACY	4 CIL. 2.2 L	1999 - 1999
SUBARU	OUTBACK	4 CIL. 2.5 L	2007 - 2000
SUBARU	LEGACY	4 CIL. 2.5 L	2007 - 2000

SUBARU BAJA 4 CIL. 2.5 L 2006 - 2003

**T41227**



**T41230**

Acero Lisa/Posterior (28mm x 8mm x 34mm)



VOLKSWAGEN TOUAREG V8, 4.2 L 2006 - 2006

**T41231**

Tipo Hidráulico - Acero Lisa/Posterior (55mm x 8mm x 24mm) - c/Tornillo, Tuerca



AUDI	S4	V6, 2.7 L	2002	-	2000
AUDI	A6	V6, 2.7 L	2004	-	2000
AUDI	A4	V6, 2.8 L	2001	-	1998
AUDI	ALLROAD QUATTR	V6, 2.7 L	2005	-	2001
AUDI	A6	V6, 2.8 L	2001	-	1998
VOLKSWAGEN	PASSAT	V6, 2.8 L	2005	-	1998

**T41228**

Acero Lisa/Posterior (58mm x 10.1mm x 36mm) -



VOLKSWAGEN TOUAREG V8, 4.2 L 2006 - 2006

**T41229**

Acero Lisa/Posterior (40mm x 8mm x 36mm)



VOLKSWAGEN	EUROVAN	4 CIL. 1.9 L DIESEL	2009	-	2008
VOLKSWAGEN	JETTA	4 CIL. 1.9 L DIESEL	2005	-	2007
VOLKSWAGEN	BORA	4 CIL. 1.9 L DIESEL	2007	-	2007
VOLKSWAGEN	BORA	4 CIL. 2.0 L DIESEL	2009	-	2010
VOLKSWAGEN	EUROVAN	4 CIL. 1.9 L DIESEL	2006	-	2006

ACURA	MDX	V6, 3.7 L	2008	-	2007
ACURA	RL	V6, 3.5 L	2006	-	2008
HONDA	PILOT	V6, 3.5 L	2008	-	2005
ACURA	MDX	V6, 3.7 L	2007	-	2010
ACURA	TL	V6, 3.5 L	2008	-	2007
ACURA	TL	V6, 3.7 L	2009	-	2010
HONDA	PILOT	V6, 3.5 L	2008	-	2010
HONDA	RIDGELINE	V6, 3.5 L	2008	-	2006
HONDA	ACCORD	V6, 3.5 L	2008	-	2010
ACURA	TSX	V6, 3.5 L	2010	-	2010
HONDA	ODYSSEY	V6, 3.5 L	2008	-	2010
ACURA	MDX	V6, 3.5 L	2006	-	2006
ACURA	MDX	V6, 3.5 L	2006	-	2003
HONDA	ACCORD	V6, 3.0 L	2007	-	2003
HONDA	ACCORD	V6, 3.5 L	2008	-	2008
ACURA	TL	V6, 3.2 L	2008	-	2005
ACURA	RL	V6, 3.5 L	2008	-	2007
HONDA	ODYSSEY	V6, 3.5 L	2008	-	2005
HONDA	ACCORD	V6, 3.0 L Electric Assist	2007	-	2005
HONDA	RIDGELINE	V6, 3.5 L	2008	-	2010
ACURA	RL	V6, 3.7 L	2009	-	2010
ACURA	TL	V6, 3.2 L	2006	-	2008

ACURA	TL	V6, 3.5 L	2008	-	2010
SATURN	VUE	V6, 3.5 L	2007	-	2004

**T41237**



**T41232**

Acero Lisa/Posterior (55mm x 19mm x 24mm)



RENAULT	STEPWAY	4 CIL. 1.6 L	2010	-	2010
RENAULT	SANDERO	4 CIL. 1.6 L	2010	-	2010
RENAULT	EUROCLIO	4 CIL. 1.6 L	2007	-	2008
RENAULT	KANGOO	4 CIL. 1.6 L	2003	-	2010
NISSAN	APRIO	4 CIL. 1.6 L	2008	-	2010
NISSAN	PLATINA	4 CIL. 1.6 L	2002	-	2010
RENAULT	KANGOO EXPRES!	4 CIL. 1.6 L	2005	-	2009
RENAULT	CLIO	4 CIL. 1.6 L	2003	-	2009

ACURA	MDX	V6, 3.5 L	2006	-	2006
ACURA	TL	V6, 3.2 L	2006	-	2008
ACURA	TSX	V6, 3.5 L	2010	-	2010
ACURA	TL	V6, 3.5 L	2008	-	2010
HONDA	ACCORD	V6, 3.5 L	2008	-	2010
ACURA	RL	V6, 3.7 L	2009	-	2010
HONDA	PILOT	V6, 3.5 L	2008	-	2010
HONDA	ODYSSEY	V6, 3.5 L	2006	-	2007
HONDA	RIDGELINE	V6, 3.5 L	2006	-	2007
ACURA	TL	V6, 3.7 L	2009	-	2010
HONDA	ODYSSEY	V6, 3.5 L	2008	-	2010
ACURA	MDX	V6, 3.7 L	2007	-	2010
HONDA	PILOT	V6, 3.5 L	2006	-	2007
HONDA	RIDGELINE	V6, 3.5 L	2008	-	2010
HONDA	ACCORD	V6, 3.0 L	2007	-	2007
ACURA	RL	V6, 3.5 L	2006	-	2008

**T41239**



SUBARU	IMPREZA	4 CIL. 2.5 L	2007	-	2004
SUBARU	LEGACY	4 CIL. 2.5 L	2007	-	2005
SUBARU	FORESTER	4 CIL. 2.5 L	2007	-	2004
SUBARU	BAJA	4 CIL. 2.5 L	2006	-	2004
SUBARU	IMPREZA	4 CIL. 2.0 L	2005	-	2004
SUBARU	OUTBACK	4 CIL. 2.5 L	2006	-	2005

**T41235**

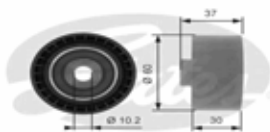

PEUGEOT	307	4 CIL. 2.0 L	2005	-	2008
---------	-----	--------------	------	---	------

**T41240**

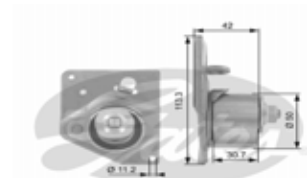

RENAULT	TRAFIC	4 CIL. 1.9 L DIESEL	2008	-	2010
---------	--------	---------------------	------	---	------

**T41241**



HYUNDAI	ATOS	4 CIL. 1.1 L	2008	-	2010
HYUNDAI	ATOS	4 CIL. 1.1 L	2005	-	2008
HYUNDAI	ATOS	4 CIL. 1.0 L	2004	-	2004

ISUZU	STYLUS	4 CIL. 1.6 L	1991	-	1991
GEO	STORM	4 CIL. 1.6 L	1991	-	1990
ISUZU	STYLUS	4 CIL. 1.8 L	1992	-	1992
ISUZU	IMPULSE	4 CIL. 1.8 L	1992	-	1992
ISUZU	I-MARK	4 CIL. 1.6 L	1989	-	1989
ISUZU	IMPULSE	4 CIL. 1.6 L	1992	-	1990
MAZDA	929	V6, 3.0 L	1991	-	1988
MAZDA	MPV	V6, 3.0 L	1998	-	1989

**T42002**



ISUZU	RODEO	V6, 3.2 L	1997	-	1993
ACURA	SLX	V6, 3.2 L	1997	-	1996
ISUZU	TROOPER	V6, 3.2 L	1997	-	1992
HONDA	PASSPORT	V6, 3.2 L	1997	-	1994
HONDA	PASSPORT	V6, 3.2 L	1997	-	1997

**T41243**



CADILLAC	CTS	V6, 3.2 L	2004	-	2003
SATURN	L-SERIES	V6, 3.0 L	2005	-	2002
SATURN	VUE	V6, 3.0 L	2003	-	2002
SAAB	9 - 5	V6, 3.0 L	2003	-	1999

**T42003**



FORD	PROBE	4 CIL. 2.2 L	1992	-	1992
KIA	SPORTAGE	4 CIL. 2.0 L	1995	-	1995
MAZDA	B2200 PICKUP	4 CIL. 2.2 L	1993	-	1992
MAZDA	MX-6	4 CIL. 2.2 L	1992	-	1988
MAZDA	626	4 CIL. 2.2 L	1992	-	1988

**T41267**

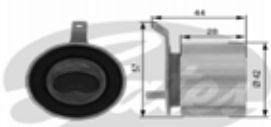

PONTIAC	MATIZ G2	4 CIL. 1.0 L	2003	-	2009
---------	----------	--------------	------	---	------

**T42001**



ISUZU	I-MARK	4 CIL. 1.6 L (Canada)	1990	-	1990
-------	--------	-----------------------	------	---	------

**T42004**



KIA	SPORTAGE	4 CIL. 2.0 L	2002 - 1995
-----	----------	--------------	-------------

**T42005**

Acero Lisa/Posterior (52mm x 10.5mm x 25mm)



FORD	ESCORT	4 CIL. 1.8 L	1996 - 1996
------	--------	--------------	-------------

**T42006**



MAZDA	929	V6, 3.0 L	1991 - 1990
-------	-----	-----------	-------------

**T42007**



MAZDA	929	V6, 3.0 L	1991 - 1990
-------	-----	-----------	-------------

**T42008**



FORD	PROBE	4 CIL. 2.0 L	1997 - 1993
MAZDA	PROTEGE	4 CIL. 2.0 L	2003 - 2001
MAZDA	MX-6	4 CIL. 2.0 L	1997 - 1993
MAZDA	626	4 CIL. 2.0 L	2002 - 1993

**T42009**



FORD	PROBE	V6, 2.5 L	1997 - 1993
MAZDA	626	V6, 2.5 L	2002 - 1993
MAZDA	MX-3	V6, 1.8 L (Canada)	1995 - 1995
MAZDA	MX-6	V6, 2.5 L	1997 - 1993
MAZDA	MX-3	V6, 1.8 L	1994 - 1992
MAZDA	MILLENIA	V6, 2.5 L	2002 - 1995

**T42010**



FORD	PROBE	V6, 2.5 L	1997 - 1993
MAZDA	MX-6	V6, 2.5 L	1997 - 1993
MAZDA	626	V6, 2.5 L	2002 - 1993
MAZDA	MILLENIA	V6, 2.5 L	2002 - 1995
MAZDA	MX-3	V6, 1.8 L (Canada)	1995 - 1995
MAZDA	MILLENIA	V6, 2.3 L	2002 - 1995

MAZDA	MX-3	V6, 1.8 L	1994	-	1992
-------	------	-----------	------	---	------

**T42011**



MAZDA	929	V6, 3.0 L	1991	-	1988
-------	-----	-----------	------	---	------

MAZDA	MPV	V6, 3.0 L	1998	-	1992
-------	-----	-----------	------	---	------

**T42012**



MAZDA	929	V6, 3.0 L	1995	-	1992
-------	-----	-----------	------	---	------

**T42013**



MAZDA	929	V6, 3.0 L	1995	-	1992
-------	-----	-----------	------	---	------

**T42014**



HYUNDAI	SONATA	V6, 2.7 L	2005	-	2002
---------	--------	-----------	------	---	------

HYUNDAI	TIBURON	V6, 2.7 L	2006	-	2003
---------	---------	-----------	------	---	------

HYUNDAI	SONATA	V6, 2.5 L	2001	-	1999
---------	--------	-----------	------	---	------

KIA	MAGENTIS	V6, 2.7 L (Canada)	2006	-	2002
-----	----------	--------------------	------	---	------

KIA	SPORTAGE	V6, 2.7 L	2007	-	2005
-----	----------	-----------	------	---	------

HYUNDAI	SANTA FE	V6, 2.7 L	2006	-	2001
---------	----------	-----------	------	---	------

KIA	MAGENTIS	V6, 2.5 L (Canada)	2001	-	2001
-----	----------	--------------------	------	---	------

KIA	OPTIMA	V6, 2.7 L	2006	-	2002
-----	--------	-----------	------	---	------

HYUNDAI	TUCSON	V6, 2.7 L	2006	-	2005
---------	--------	-----------	------	---	------

KIA	OPTIMA	V6, 2.5 L	2001	-	2001
-----	--------	-----------	------	---	------

**T42015**



HYUNDAI	ELANTRA	4 CIL. 2.0 L	2006	-	1999
---------	---------	--------------	------	---	------

HYUNDAI	TUCSON	4 CIL. 2.0 L	2006	-	2005
---------	--------	--------------	------	---	------

HYUNDAI	TIBURON	4 CIL. 2.0 L	2006	-	1997
---------	---------	--------------	------	---	------

HYUNDAI	ELANTRA	4 CIL. 1.8 L	1998	-	1996
---------	---------	--------------	------	---	------

KIA	SPORTAGE	4 CIL. 2.0 L	2006	-	2005
-----	----------	--------------	------	---	------

KIA	SPECTRA	4 CIL. 2.0 L	2007	-	2004
-----	---------	--------------	------	---	------

HYUNDAI	TIBURON	4 CIL. 1.8 L	1998	-	1997
---------	---------	--------------	------	---	------

**T42016**

Acero Lisa/Posterior (55mm x 10.3mm x 25mm)



HYUNDAI	ATTITUDE	4 CIL. 1.6 L	2006	-	2007
---------	----------	--------------	------	---	------

HYUNDAI	ATTITUDE	4 CIL. 1.6 L	2008	-	2010
---------	----------	--------------	------	---	------

HYUNDAI	ACCENT	4 CIL. 1.6 L	2006	-	2006
---------	--------	--------------	------	---	------

HYUNDAI	ATTITUDE	4 CIL. 1.4 L	2008	-	2010
---------	----------	--------------	------	---	------

**T42017**

Acero Lisa/Posterior (60mm x 10.5mm x 32mm)



DODGE	STRATUS	4 CIL. 2.4 L	2001 - 2004
CHRYSLER	SEBRING	4 CIL. 2.4 L	2004 - 2004
MITSUBISHI	LANCER	4 CIL. 2.0 L	2004 - 2005

**T42018**

Acero Lisa/Posterior (57.5mm x 10.3mm x 38mm) -



DODGE	STRATUS	V6, 2.5 L	1995 - 2000
CHRYSLER	SEBRING	V6, 3.0 L	2001 - 2005
CHRYSLER	CIRRUS	V6, 2.5 L	2000 - 2000
CHRYSLER	SEBRING	V6, 2.5 L	1996 - 2000
DODGE	STRATUS	V6, 3.0 L	2001 - 2003
MITSUBISHI	ECLIPSE	V6, 3.0 L	2004 - 2005
MITSUBISHI	MONTERO SPORT	V6, 3.5 L	2004 - 2004
MITSUBISHI	MONTERO	V6, 3.8 L	2004 - 2005
MITSUBISHI	MONTERO	V6, 3.8 L	2006 - 2007
MITSUBISHI	GALANT	V6, 3.8 L	2004 - 2005
MITSUBISHI	ENDEAVOR	V6, 3.8 L	2004 - 2007
MITSUBISHI	ECLIPSE	V6, 3.8 L	2007 - 2008

**T42019**

Acero Lisa/Posterior (28mm x 10mm x 27mm) - c/Tornillo



AUDI	A4	4 CIL. 1.8 L	2006 - 2006
------	----	--------------	-------------

AUDI	A3	4 CIL. 2.0 L	2006 - 2008
SEAT	ALTEA	4 CIL. 2.0 L	2008 - 2008
SEAT	TOLEDO	4 CIL. 2.0 L	2006 - 2007
VOLKSWAGEN	GTI	4 CIL. 2.0 L TURBO	2007 - 2008
VOLKSWAGEN	GLI	4 CIL. 2.0 L TURBO	2007 - 2008
SEAT	LEON	4 CIL. 2.0 L	2006 - 2007

**T42020**

Acero Lisa/Posterior (60mm x 10.5mm x 36mm)



NISSAN	300ZX	V6, 3.0 L	1996 - 1996
--------	-------	-----------	-------------

**T42021**

Acero Lisa/Posterior (50mm x 10.5mm x 36mm)



NISSAN	300ZX	V6, 3.0 L	1996 - 1996
--------	-------	-----------	-------------

**T42022**



SUBARU	DL	4 CIL. 1.8 L	1989 - 1985
SUBARU	GL-10	4 CIL. 1.8 L	1989 - 1985
SUBARU	RX	4 CIL. 1.8 L	1989 - 1985
SUBARU	GL	4 CIL. 1.8 L	1989 - 1985
SUBARU	XT	4 CIL. 1.8 L	1991 - 1985
SUBARU	LOYALE	4 CIL. 1.8 L	1994 - 1990

**T42023**

Acero Lisa/Posterior (60mm x 10.5mm x 35mm)



SUBARU	OUTBACK	4 CIL. 2.5 L	2006	-	2006
SUBARU	LEGACY	4 CIL. 2.5 L	2006	-	2006
SUBARU	FORESTER	4 CIL. 2.5 L	2006	-	2006
SUBARU	IMPREZA	4 CIL. 2.5 L	2006	-	2006

**T42024**

Acero Cog (60mm x 10.5mm x 35mm)



SUBARU	OUTBACK	4 CIL. 2.5 L	2006	-	2006
SUBARU	LEGACY	4 CIL. 2.5 L	2006	-	2006
SUBARU	IMPREZA	4 CIL. 2.5 L	2006	-	2006
SUBARU	FORESTER	4 CIL. 2.5 L	2006	-	2006

**T42025**

Acero Lisa/Posterior (57.5mm x 12mm x 29mm)



TOYOTA	CAMRY	4 CIL. 2.2 L	2001	-	2001
--------	-------	--------------	------	---	------

**T42026**

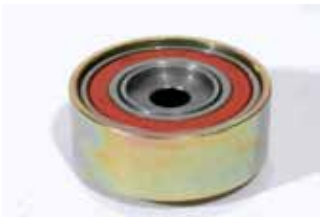

TOYOTA	PICKUP	4 CIL. 2.4 L Diesel	1986	-	1984
TOYOTA	PICKUP	4 CIL. 2.4 L Diesel (Cana)	1987	-	1987
TOYOTA	PICKUP	4 CIL. 2.2 L Diesel	1983	-	1981

**T42027**



TOYOTA	CAMRY	4 CIL. 1.8 L Diesel	1985	-	1984
TOYOTA	CAMRY	4 CIL. 2.0 L Diesel	1986	-	1986
TOYOTA	COROLLA	4 CIL. 1.8 L Diesel	1985	-	1984

**T42028**



TOYOTA	TERCEL	4 CIL. 1.5 L	1994	-	1992
--------	--------	--------------	------	---	------

**T42029**



TOYOTA	TERCEL	4 CIL. 1.5 L	1998	-	1995
TOYOTA	PASEO	4 CIL. 1.5 L	1997	-	1992
TOYOTA	PASEO	4 CIL. 1.5 L (Canada)	1999	-	1998
TOYOTA	TERCEL	4 CIL. 1.5 L (Canada)	1999	-	1999



**T42030**

Acero Lisa/Posterior (62mm x 12mm x 36.5mm)

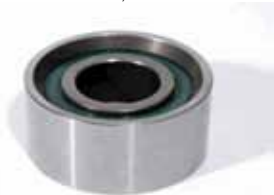

TOYOTA	HIGHLANDER	V6, 3.3 L Electric Assist	2008	-	2006
TOYOTA	HIGHLANDER	V6, 3.3 L (Canada)	2008	-	2008
TOYOTA	HIGHLANDER	V6, 3.0 L	2003	-	2001
TOYOTA	HIGHLANDER	V6, 3.3 L	2007	-	2004
TOYOTA	SIENNA	V6, 3.3 L	2006	-	2004
TOYOTA	SIENNA	V6, 3.3 L	2004	-	2006
TOYOTA	SIENNA	V6, 3.0 L	2003	-	1998
TOYOTA	SIENNA	V6, 3.0 L	2000	-	2003
TOYOTA	AVALON	V6, 3.0 L	2004	-	2004
TOYOTA	CAMRY SOLARA	V6, 3.0 L	2000	-	1999
TOYOTA	CAMRY	V6, 3.3 L	2006	-	2004
TOYOTA	SOLARA	V6, 3.0 L	2003	-	2001
TOYOTA	SOLARA	V6, 3.3 L	2008	-	2004
TOYOTA	CAMRY	V6, 3.0 L	2006	-	1992
TOYOTA	CAMRY	V6, 3.0 L	2001	-	2006
TOYOTA	SOLARA	V6, 3.3 L	2005	-	2006

**T42032**

Plastic Lisa/Posterior (60mm x 10.4mm x 29mm)



FORD	CONTOUR	4 CIL. 2.0 L	1995	-	1995
FORD	CONTOUR	4 CIL. 2.0 L	1997	-	1997
MERCURY	MYSTIQUE	4 CIL. 2.0 L	1995	-	1997

**T42033**

Plastic Lisa/Posterior (48mm x 10.4mm x 28.5mm)



FORD	CONTOUR	4 CIL. 2.0 L	1995	-	1995
FORD	CONTOUR	4 CIL. 2.0 L	1997	-	1997
MERCURY	MYSTIQUE	4 CIL. 2.0 L	1995	-	1997

**T42034**

Plastic Lisa/Posterior (47mm x 17mm x 29mm) - c/Buje, Tornillo



FORD	FOCUS	4 CIL. 2.0 L	2000	-	2004
FORD	ESCAPE	4 CIL. 2.0 L	2001	-	2002
FORD	ESCORT	4 CIL. 2.0 L	1998	-	2002
FORD	ZX2	4 CIL. 2.0 L	2003	-	2003
FORD	CONTOUR	4 CIL. 2.0 L	2000	-	2000
MERCURY	MYSTIQUE	4 CIL. 2.0 L	1998	-	2000

**T42031**

Acero Lisa/Posterior (66mm x 12mm x 37.5mm)



TOYOTA	SEQUOIA	V8, 4.7 L	2007	-	2008
TOYOTA	4 RUNNER	V8, 4.7 L	2007	-	2007
TOYOTA	TUNDRA	V8, 4.7 L	2007	-	2008
TOYOTA	LAND CRUISER	V8, 4.7 L	2003	-	2006

**T42035**

Plastic Lisa/Posterior (70mm x 10.4mm x 29mm)



FORD	CONTOUR	4 CIL. 2.0 L	1999 - 1999
FORD	ESCORT	4 CIL. 2.0 L	1998 - 1999
MERCURY	MYSTIQUE	4 CIL. 2.0 L	1998 - 1999

**T42038**

Acero Lisa/Posterior (55mm x 19.2mm x 30mm)



HONDA	ACCORD	V6, 3.0 L	1998 - 2001
HONDA	ACCORD	V6, 3.0 L	2001 - 1998
ACURA	TL	V6, 3.2 L	2000 - 2000
ACURA	TL	V6, 3.2 L	2000 - 1999

**T42036**

Plastic Lisa/Posterior (60mm x 10.4mm x 29mm) - c/Espaciador



FORD	CONTOUR	4 CIL. 2.0 L	2000 - 2000
FORD	FOCUS	4 CIL. 2.0 L	2000 - 2004
FORD	ESCAPE	4 CIL. 2.0 L	2001 - 2002
FORD	ESCORT	4 CIL. 2.0 L	1999 - 2002
FORD	ZX2	4 CIL. 2.0 L	2003 - 2003
MERCURY	MYSTIQUE	4 CIL. 2.0 L	1999 - 2000

**T42044**

Acero Lisa/Posterior (28mm x 8mm x 29mm)



AUDI	A4	4 CIL. 1.8 L	2000 - 1997
VOLKSWAGEN	GOLF	4 CIL. 1.9 L Diesel	2005 - 1999
VOLKSWAGEN	TOUAREG	V6, 3.0 L DIESEL	2009 - 2010
VOLKSWAGEN	PASSAT	4 CIL. 1.8 L	2000 - 1998
VOLKSWAGEN	BEETLE	4 CIL. 1.9 L Diesel	2004 - 1998
VOLKSWAGEN	JETTA	4 CIL. 1.9 L Diesel	2003 - 1999

**T42037**



TOYOTA	T100	V6, 3.0 L	1994 - 1993
TOYOTA	PICKUP	V6, 3.0 L	1995 - 1992
TOYOTA	4 RUNNER	V6, 3.0 L	1995 - 1992

**T42050**

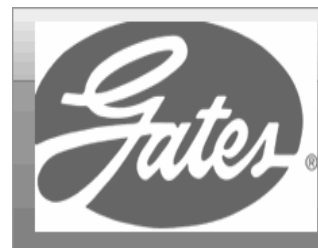

VOLKSWAGEN	BEETLE	4 CIL. 1.9 L Diesel	2004 - 1998
VOLKSWAGEN	JETTA	4 CIL. 1.9 L Diesel	2003 - 1999
VOLKSWAGEN	GOLF	4 CIL. 1.9 L Diesel	2005 - 1999

**T42061**

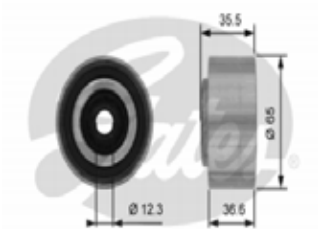

FIAT	PALIO	4 CIL. 1.6 L	2006 - 2006
FIAT	PALIO ADVENTURE	4 CIL. 1.6 L	2003 - 2006

**T42066**

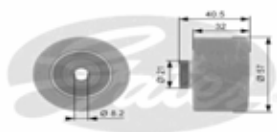

PEUGEOT	PARTNER	4 CIL. 1.6 L	2006 - 2008
PEUGEOT	GRAND RAID	4 CIL. 1.6 L	2004 - 2008

**T42086**



CADILLAC	CATERA	V6, 3.0 L	2001 - 1997
SATURN	VUE	V6, 3.0 L	2003 - 2002
SATURN	L-SERIES	V6, 3.0 L	2005 - 2000
SAAB	9-5	V6, 3.0 L	2003 - 1999

**T42097**

Acero Lisa/Posterior (53mm x N/A x 27.1mm)



VOLVO	S40	5 CIL. 2.5 L	2007 - 2004
-------	-----	--------------	-------------

VOLVO	S60	5 CIL. 2.3 L	2004 - 2001
VOLVO	S40	5 CIL. 2.4 L	2008 - 2004
VOLVO	S60	5 CIL. 2.4 L	2008 - 2001
VOLVO	S40	5 CIL. 2.5 L	2007 - 2008
VOLVO	S60	5 CIL. 2.5 L	2007 - 2003
VOLVO	V70	5 CIL. 2.3 L	2004 - 1998
VOLVO	S80	5 CIL. 2.5 L	2006 - 2004
VOLVO	V50	5 CIL. 2.5 L	2007 - 2005
VOLVO	C30	5 CIL. 2.5 L	2008 - 2008
VOLVO	V50	5 CIL. 2.4 L	2007 - 2005
VOLVO	S70	5 CIL. 2.4 L	2000 - 1998
VOLVO	S70	5 CIL. 2.3 L	2000 - 1998
VOLVO	C30	5 CIL. 2.4 L (Canada)	2008 - 2007
VOLVO	XC90	5 CIL. 2.5 L	2006 - 2003
VOLVO	XC90	5 CIL. 2.5 L	2003 - 2006
VOLVO	XC70	5 CIL. 2.5 L	2004 - 2004
VOLVO	V70	5 CIL. 2.5 L	2007 - 2003
VOLVO	C30	5 CIL. 2.5 L	2008 - 2010
VOLVO	C30	5 CIL. 2.4 L	2008 - 2010
VOLVO	S40	5 CIL. 2.4 L	2005 - 2008
VOLVO	V40	4 CIL. 1.9 L	2004 - 2000
VOLVO	C70	5 CIL. 2.4 L	2004 - 1999
VOLVO	S40	4 CIL. 1.9 L	2004 - 2000
VOLVO	V70	5 CIL. 2.4 L	2007 - 1998
VOLVO	C30	5 CIL. 2.5 L (Canada)	2007 - 2007
VOLVO	C70	5 CIL. 2.3 L	2004 - 1998

**T42113**



CHEVROLET	LUMINA	V6, 3.4 L	1997 - 1992
CHEVROLET	MONTE CARLO	V6, 3.4 L	1997 - 1995
PONTIAC	GRAND PRIX	V6, 3.4 L	1996 - 1992
OLDSMOBILE	CUTLASS SUPREM	V6, 3.4 L	1996 - 1992

**T42115**



ISUZU	TROOPER	V6, 3.5 L	2002 - 1998
ISUZU	RODEO	V6, 3.2 L	2004 - 1998
ISUZU	AMIGO	V6, 3.2 L	2000 - 1998
HONDA	PASSPORT	V6, 3.2 L	2002 - 1998
ACURA	SLX	V6, 3.5 L	1999 - 1999
ACURA	SLX	V6, 3.5 L	1999 - 1998
ISUZU	RODEO	V6, 3.5 L	2004 - 2004

**T42118**



SUBARU	SVX	6 CIL. 3.3 L	1997 - 1992
--------	-----	--------------	-------------

**T42119**



SUBARU	SVX	6 CIL. 3.3 L	1997 - 1992
--------	-----	--------------	-------------

**T42116**



MAZDA	PROTEGE	4 CIL. 1.5 L	1998 - 1995
MAZDA	PROTEGE	4 CIL. 1.5 L	1997 - 1997

**T42121**

Acero Lisa/Posterior (58mm x N/A x 35.2mm) - c/Tornillo



**T42117**



MAZDA	MILLENNIA	V6, 2.3 L	2002 - 1995
-------	-----------	-----------	-------------

CHRYSLER	SEBRING	4 CIL. 2.4 L	1996 - 2005
JEEP	WRANGLER	4 CIL. 2.4 L	2003 - 2006
CHRYSLER	PT CRUISER	4 CIL. 2.4 L	2008 - 2010
CHRYSLER	PT CRUISER	4 CIL. 2.4 L	2001 - 2005
DODGE	CARAVAN	4 CIL. 2.4 L	1997 - 2002
DODGE	NEON	4 CIL. 2.4 L	2003 - 2005
DODGE	STRATUS	4 CIL. 2.4 L	1995 - 2006
CHRYSLER	CIRRUS	4 CIL. 2.4 L	2000 - 2000

**T42129**



HYUNDAI	H100	4 CIL. 2.5 L DIESEL	2009 - 2010
HYUNDAI	H100 VAN/WAGON	4 CIL. 2.5 L DIESEL	2009 - 2010

**T42137**

Acero Lisa/Posterior (59mm x 10mm x 34mm)



AUDI	A4	V6, 3.0 L	2006 - 2002
AUDI	A4	V6, 3.0 L	2006 - 2006
AUDI	A6	V6, 3.0 L	2004 - 2002

**T42138**

Acero Lisa/Posterior (59mm x 10mm x 37mm) -



AUDI	A4	V6, 3.0 L	2006 - 2006
AUDI	A4	V6, 3.0 L	2006 - 2002
AUDI	A6	V6, 3.0 L	2004 - 2002

**T42144**



ACURA	RL	V6, 3.5 L	2004 - 1996
-------	----	-----------	-------------

**T42146**



SUBARU	IMPREZA	4 CIL. 2.2 L	2001 - 1997
SUBARU	LEGACY	4 CIL. 2.2 L	1999 - 1998
SUBARU	OUTBACK	4 CIL. 2.5 L	2007 - 2000
SUBARU	LEGACY	4 CIL. 2.5 L	2007 - 1997
SUBARU	IMPREZA	4 CIL. 2.5 L	2007 - 1998
SUBARU	IMPREZA	4 CIL. 2.0 L	2005 - 2002
SUBARU	BAJA	4 CIL. 2.5 L	2006 - 2003
SUBARU	FORESTER	4 CIL. 2.5 L	2007 - 1998

**T42163**



FIAT	DUCATO	4 CIL. 2.3 L DIESEL	2008 - 2010
------	--------	---------------------	-------------

**T42166**

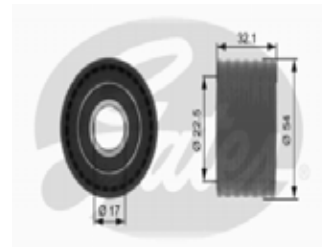

RENAULT	SCENIC	4 CIL. 2.0 L	2001 - 2007
RENAULT	SCENIC	4 CIL. 2.0 L	2009 - 2009
RENAULT	MEGANE	4 CIL. 2.0 L	2001 - 2008
RENAULT	CLIO	4 CIL. 2.0 L SPORT	2006 - 2006
RENAULT	MEGANE	4 CIL. 2.0 L	2009 - 2009

**T42167**

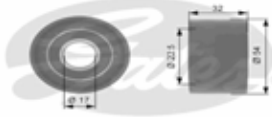

RENAULT	MEGANE	4 CIL. 2.0 L	2004 - 2009
RENAULT	SCENIC	4 CIL. 2.0 L	2004 - 2009

**T43002**



PONTIAC	LEMANS	4 CIL. 2.0 L	1990 - 1989
PONTIAC	GRAND AM	4 CIL. 2.0 L	1989 - 1989
PONTIAC	SUNBIRD	4 CIL. 2.0 L	1994 - 1989

**T42170**

Plastic Lisa/Posterior (64mm x 10mm x 29mm) - c/Tornillo



CHEVROLET	AVEO	4 CIL. 1.6 L	2008 - 2009
SUZUKI	SWIFT	4 CIL. 1.6 L	2008 - 2008

**T43003**

Tipo de Resorte - Plastic Lisa/Posterior (60mm x 8mm x 30mm)



FORD	CONTOUR	4 CIL. 2.0 L	1998 - 2000
FORD	ZX2	4 CIL. 2.0 L	2003 - 2003
FORD	ESCORT	4 CIL. 2.0 L	1998 - 2002
FORD	ESCAPE	4 CIL. 2.0 L	2001 - 2002
FORD	FOCUS	4 CIL. 2.0 L	2000 - 2004
MERCURY	MYSTIQUE	4 CIL. 2.0 L	1998 - 2000

**T42191**



PEUGEOT	207	4 CIL. 1.6 L	2008 - 2009
---------	-----	--------------	-------------

**T43001**

Tipo de Resorte - Acero Lisa/Posterior (67mm x 9mm x 33mm)



**T43004**

Tipo de Resorte - Acero Lisa/Posterior (65mm x 8.5mm x 32mm)



FORD	ESCORT	4 CIL. 2.0 L	1997 - 2002
FORD	FOCUS	4 CIL. 2.0 L	2000 - 2004

DODGE	NEON	4 CIL. 2.0 L	1996 - 2005
DODGE	STRATUS	4 CIL. 2.0 L	1996 - 2000
CHRYSLER	CIRRUS	4 CIL. 2.0 L	2000 - 2000

**T43005**

Acero Lisa/Posterior (70mm x 8.5mm x 32mm)



CHRYSLER	CIRRUS	4 CIL. 2.4 L	1996 - 2000
DODGE	CARAVAN	4 CIL. 2.4 L	1997 - 2002
CHRYSLER	PT CRUISER	4 CIL. 2.4 L	2001 - 2002
CHRYSLER	SEBRING	4 CIL. 2.4 L	1996 - 2002
DODGE	STRATUS	4 CIL. 2.4 L	1996 - 2002

**T43008**

Tipo de Resorte - Acero Lisa/Posterior (67mm x 8mm x 33mm)



CHRYSLER	PT CRUISER	4 CIL. 2.4 L	2001 - 2005
CHRYSLER	PT CRUISER	4 CIL. 2.4 L	2008 - 2010
CHRYSLER	CIRRUS	4 CIL. 2.4 L	1997 - 2000
DODGE	STRATUS	4 CIL. 2.4 L	1997 - 2006
JEEP	WRANGLER	4 CIL. 2.4 L	2003 - 2006
CHRYSLER	SEBRING	4 CIL. 2.4 L	1997 - 2005
DODGE	CARAVAN	4 CIL. 2.4 L	1997 - 2002
DODGE	NEON	4 CIL. 2.4 L	2003 - 2005

**T43006**



VOLKSWAGEN	GOLF	4 CIL. 1.9 L Diesel	1996 - 1996
VOLKSWAGEN	PASSAT	4 CIL. 1.9 L Diesel	1998 - 1996
VOLKSWAGEN	JETTA	4 CIL. 1.9 L Diesel	1998 - 1996
VOLKSWAGEN	GOLF	4 CIL. 1.9 L	1998 - 1998
VOLKSWAGEN	GOLF	4 CIL. 1.9 L Diesel (Cana1998	- 1993
VOLKSWAGEN	PASSAT	4 CIL. 1.9 L Diesel (Cana1995	- 1993
VOLKSWAGEN	JETTA	4 CIL. 1.9 L Diesel (Cana1995	- 1993

**T43010**

Tipo de Resorte - Acero Lisa/Posterior (72mm x 8mm x 30mm) -



VOLKSWAGEN	GOLF	4 CIL. 2.0 L	1999 - 2006
SEAT	CORDOBA	4 CIL. 2.0 L	2003 - 2007
VOLKSWAGEN	BEETLE	4 CIL. 2.0 L	1998 - 2005
SEAT	IBIZA	4 CIL. 2.0 L	2003 - 2009
VOLKSWAGEN	JETTA	4 CIL. 2.0 L	1999 - 2005

**T43007**



VOLKSWAGEN	JETTA	4 CIL. 1.9 L Diesel	2003 - 1999
VOLKSWAGEN	BEETLE	4 CIL. 1.9 L	2004 - 2004
VOLKSWAGEN	BEETLE	4 CIL. 1.9 L Diesel	2004 - 1998
VOLKSWAGEN	GOLF	4 CIL. 1.9 L Diesel	2005 - 1999

**T43016**

Tipo Hidráulico - Acero Lisa/Posterior (72mm x 18mm x 30mm) - , c/Bracket, Buje, Tornillo, Rondana



VOLKSWAGEN	SHARAN	4 CIL. 1.8 L	2003 - 2007
SEAT	ALHAMBRA	4 CIL. 1.8 L	2003 - 2007

**T43017**

Tipo Excéntrica - Acero Lisa/Posterior (72mm x 10mm x 30mm) - , c/Buje, Tornillo



VOLKSWAGEN	SHARAN	4 CIL. 1.8 L	2003 - 2007
SEAT	TOLEDO	4 CIL. 1.8 L	2003 - 2005
SEAT	LEON	4 CIL. 1.8 L	2003 - 2005
SEAT	ALHAMBRA	4 CIL. 1.8 L	2003 - 2007

**T43025**



AUDI	TT	4 CIL. 1.8 L	2006 - 2000
VOLKSWAGEN	PASSAT	4 CIL. 1.8 L	2000 - 2000
VOLKSWAGEN	GOLF	4 CIL. 1.8 L	2006 - 2000
VOLKSWAGEN	JETTA	4 CIL. 1.8 L	2005 - 2000
VOLKSWAGEN	BEETLE	4 CIL. 1.8 L	2005 - 1999

**T43018**

Tipo Hidráulico - Acero Lisa/Posterior (72mm x 8mm x 30mm) -



AUDI	A4	4 CIL. 1.8 L	2006 - 1999
AUDI	A4	4 CIL. 1.8 L	2006 - 2006
VOLKSWAGEN	PASSAT	4 CIL. 1.8 L	2005 - 2002

**T43026**



AUDI	S4	V6, 2.7 L	2002 - 2000
AUDI	ALLROAD QUATTR	V6, 2.7 L	2005 - 2001
AUDI	A6	V6, 2.7 L	2004 - 2000
AUDI	A4	V6, 2.8 L	2001 - 1999
AUDI	A6	V6, 2.8 L	2001 - 1998
VOLKSWAGEN	PASSAT	V6, 2.8 L	2005 - 1998

**T43022**

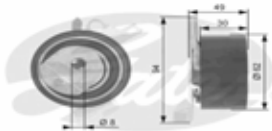

PEUGEOT	307	4 CIL. 2.0 L	2005 - 2008
---------	-----	--------------	-------------

**T43027**

Tipo Cilindro Hidráulico - Sin Polea



AUDI	A6	V6, 3.0 L	2004 - 2002
AUDI	A4	V6, 3.0 L	2006 - 2002
AUDI	A4	V6, 3.0 L	2006 - 2006

**T43023**



PEUGEOT	206	4 CIL. 1.4 L	1998 - 2008
---------	-----	--------------	-------------



**T43028**

Tipo Hidráulico - Acero Lisa/Posterior (28mm x 10mm x 27mm) - c/Bracket, Tornillo, Ensamble Hidráulico



AUDI	A4	4 CIL. 1.8 L	2006 - 1999
AUDI	A4	4 CIL. 1.8 L	2006 - 2006
VOLKSWAGEN	BEETLE	4 CIL. 1.8 L	2001 - 2000
VOLKSWAGEN	PASSAT	4 CIL. 1.8 L	2005 - 2001

**T43029**



AUDI	S8	V8, 4.2 L	2001 - 2001
AUDI	A8	V8, 4.2 L	2001 - 2000
AUDI	A6	V8, 4.2 L	2001 - 2000

**T43032**

Tipo Cilindro Hidráulico - Sin Polea



AUDI	A8	V8, 4.2 L	2007 - 2007
VOLKSWAGEN	TOUAREG	V8, 4.2 L	2006 - 2006

**T43039**

Tipo de Resorte - Plastic Lisa/Posterior (60.6mm x NA x 29.6mm) - c/Bracket, Resorte



CHEVROLET	AVEO	4 CIL. 1.6 L	2008 - 2008
SUZUKI	SWIFT	4 CIL. 1.6 L	2008 - 2008
PONTIAC	G3	4 CIL. 1.6 L	2006 - 2008

**T43055**



FIAT	GRANDE PUNTO	4 CIL. 1.4 L	2009 - 2010
FIAT	BRAVO	4 CIL. 1.4 L	2009 - 2010

**T43064**



RENAULT	SANDERO	4 CIL. 1.6 L	2010 - 2010
RENAULT	KANGOO	4 CIL. 1.6 L	2005 - 2010
RENAULT	KANGOO EXPRES!	4 CIL. 1.6 L	2005 - 2009
NISSAN	APRIO	4 CIL. 1.6 L	2008 - 2008
RENAULT	EUROCLIO	4 CIL. 1.6 L	2007 - 2008
RENAULT	CLIO	4 CIL. 1.6 L	2003 - 2009
NISSAN	PLATINA	4 CIL. 1.6 L	2002 - 2006
RENAULT	STEPWAY	4 CIL. 1.6 L	2010 - 2010
NISSAN	PLATINA	4 CIL. 1.6 L	2007 - 2010

**T43065**



AUDI	A4	4 CIL. 1.8 L	2000 - 1997
VOLKSWAGEN	PASSAT	4 CIL. 1.8 L	2000 - 1998

**T43066**



AUDI	A4	4 CIL. 1.8 L	2000 - 1997
VOLKSWAGEN	PASSAT	4 CIL. 1.8 L	2000 - 1998

**T43091**

Tipo de Resorte - Acero Lisa/Posterior (68mm x 8.2mm x 36mm) - , c/Resorte



VOLKSWAGEN	JETTA	4 CIL. 1.9 L DIESEL	2006 - 2005
VOLKSWAGEN	EUROVAN	4 CIL. 1.9 L DIESEL	2005 - 2005
VOLKSWAGEN	EUROVAN	4 CIL. 1.9 L DIESEL	2008 - 2007
VOLKSWAGEN	BORA	4 CIL. 1.9 L DIESEL	2007 - 2007

**T43067**



VOLKSWAGEN	CRAFTER	5 CIL. 2.5 L TDI	2008 - 2010
------------	---------	------------------	-------------

**T43094**

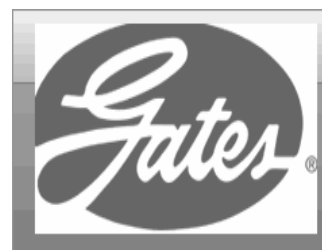

HONDA	PASSPORT	V6, 3.2 L	1995 - 1994
ISUZU	RODEO	V6, 3.2 L	1995 - 1993
ISUZU	TROOPER	V6, 3.2 L	1995 - 1992

**T43068**

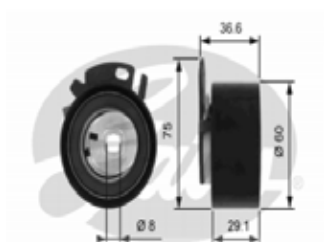

FIAT	PALIO	4 CIL. 1.6 L	2003 - 2006
FIAT	PALIO ADVENTURE	4 CIL. 1.6 L	2003 - 2006

**T43095**



ACURA	SLX	V6, 3.2 L	1997 - 1996
HONDA	PASSPORT	V6, 3.2 L	1997 - 1996
HONDA	PASSPORT	V6, 3.2 L	1997 - 1997
ISUZU	TROOPER	V6, 3.2 L	1997 - 1996
ISUZU	RODEO	V6, 3.2 L	1997 - 1996

**T43073**



AUDI	A4	V6, 2.8 L	1998 - 1998
------	----	-----------	-------------

**T43096**

Tipo Hidráulico - Sin Polea



TOYOTA	AVALON	V6, 3.0 L	2004 - 2004
TOYOTA	SOLARA	V6, 3.0 L	2003 - 2001
TOYOTA	CAMRY	V6, 3.0 L	2001 - 1995
TOYOTA	CAMRY SOLARA	V6, 3.0 L	2000 - 1999
TOYOTA	SIENNA	V6, 3.0 L	2003 - 1998
TOYOTA	SIENNA	V6, 3.0 L	2000 - 2003
TOYOTA	CAMRY	V6, 3.0 L	2001 - 2001

**T43100**



LEXUS	IS300	6 CIL. 3.0 L	2005 - 2001
LEXUS	SC300	6 CIL. 3.0 L	2000 - 1992
LEXUS	GS300	6 CIL. 3.0 L	2005 - 1993
TOYOTA	SUPRA	6 CIL. 3.0 L	1998 - 1993

**T43114**



FORD	PROBE	V6, 2.5 L	1997 - 1993
------	-------	-----------	-------------

**T43129**

Tipo Cilindro Hidráulico - Sin Polea



HONDA	ODYSSEY	V6, 3.5 L	2008 - 2005
ACURA	RL	V6, 3.5 L	2006 - 2008
ACURA	TL	V6, 3.2 L	2006 - 2008
HONDA	ACCORD	V6, 3.5 L	2008 - 2008
HONDA	ACCORD	V6, 3.0 L Electric Assist	2007 - 2005
ACURA	TL	V6, 3.2 L	2008 - 2004
ACURA	TL	V6, 3.5 L	2008 - 2007
HONDA	PILOT	V6, 3.5 L	2008 - 2010
ACURA	TL	V6, 3.7 L	2009 - 2010
HONDA	PILOT	V6, 3.5 L	2008 - 2005
HONDA	RIDGELINE	V6, 3.5 L	2008 - 2010

**T43097**

Tipo Hidráulico - Sin Polea



TOYOTA	4 RUNNER	V8, 4.7 L	2003 - 2007
TOYOTA	LAND CRUISER	V8, 4.7 L	2003 - 2006

**T43098**

Tipo Hidráulico - Sin Polea



TOYOTA	SOLARA	V6, 3.3 L	2005 - 2006
TOYOTA	CAMRY	V6, 3.0 L	2002 - 2006
TOYOTA	SIENNA	V6, 3.3 L	2004 - 2006

ACURA	TL	V6, 3.5 L	2008	-	2010
ACURA	TSX	V6, 3.5 L	2010	-	2010
ACURA	MDX	V6, 3.5 L	2006	-	2003
HONDA	ACCORD	V6, 3.0 L	2007	-	2003
ACURA	MDX	V6, 3.7 L	2008	-	2007
ACURA	RL	V6, 3.5 L	2008	-	2005
HONDA	ODYSSEY	V6, 3.5 L	2008	-	2010
HONDA	RIDGELINE	V6, 3.5 L	2007	-	2006
ACURA	MDX	V6, 3.7 L	2007	-	2010
HONDA	ACCORD	V6, 3.5 L	2008	-	2010
ACURA	RL	V6, 3.7 L	2009	-	2010
ACURA	MDX	V6, 3.5 L	2006	-	2006
SATURN	VUE	V6, 3.5 L	2007	-	2004

JEEP	WRANGLER	4 CIL. 2.4 L	2006	-	2003
JEEP	TJ	4 CIL. 2.4 L (Canada)	2006	-	2003
DODGE	CARAVAN	4 CIL. 2.4 L	2007	-	1997
CHRYSLER	PT CRUISER	4 CIL. 2.4 L	2008	-	2010
CHRYSLER	SEBRING	4 CIL. 2.4 L	2006	-	1997
DODGE	GRAND CARAVAN	4 CIL. 2.4 L	1997	-	1997
CHRYSLER	CIRRUS	4 CIL. 2.4 L	2000	-	1997

**T43132**



DODGE	NEON	4 CIL. 2.0 L	2005	-	1995
DODGE	AVENGER	4 CIL. 2.0 L	1999	-	1996
DODGE	STRATUS	4 CIL. 2.0 L	2000	-	1996
CHRYSLER	CIRRUS	4 CIL. 2.0 L	2000	-	2000
CHRYSLER	SEBRING	4 CIL. 2.0 L	1999	-	1996
CHRYSLER	NEON	4 CIL. 2.0 L (Canada)	2002	-	2000
PLYMOUTH	NEON	4 CIL. 2.0 L	2001	-	1995

**T43138**



SUBARU	FORESTER	4 CIL. 2.5 L	2007	-	1998
SUBARU	LEGACY	4 CIL. 2.2 L	1999	-	1998
SUBARU	IMPREZA	4 CIL. 2.2 L	2001	-	1997
SUBARU	LEGACY	4 CIL. 2.5 L	2007	-	1997
SUBARU	BAJA	4 CIL. 2.5 L	2006	-	2003
SUBARU	IMPREZA	4 CIL. 2.5 L	2007	-	1998
SUBARU	IMPREZA	4 CIL. 2.0 L	2005	-	2002
SUBARU	OUTBACK	4 CIL. 2.5 L	2007	-	2000

**T43130**



MITSUBISHI	LANCER	4 CIL. 2.0 L	2006	-	2003
MITSUBISHI	LANCER	4 CIL. 2.4 L	2006	-	2004
MITSUBISHI	OUTLANDER	4 CIL. 2.4 L	2006	-	2004
MITSUBISHI	GALANT	4 CIL. 2.4 L	2008	-	2004
MITSUBISHI	ECLIPSE	4 CIL. 2.4 L	2008	-	2005

**T43131**

Tipo de Resorte - Acero Lisa/Posterior (67mm x 9mm x 33mm) - c/Bracket



JEEP	LIBERTY	4 CIL. 2.4 L	2005	-	2003
DODGE	STRATUS	4 CIL. 2.4 L	2006	-	1997
CHRYSLER	VOYAGER	4 CIL. 2.4 L	2003	-	2000
CHRYSLER	PT CRUISER	4 CIL. 2.4 L	2008	-	2001
DODGE	NEON	4 CIL. 2.4 L	2005	-	2003

**T43139**

Tipo Excéntrica - Acero Lisa/Posterior (59mm x 8mm x 27.1mm)



VOLVO	S80	5 CIL. 2.5 L	2006	-	2004
VOLVO	V40	4 CIL. 1.9 L	2004	-	2000
VOLVO	XC90	5 CIL. 2.5 L	2003	-	2006
VOLVO	S70	5 CIL. 2.4 L	2000	-	1998
VOLVO	V70	5 CIL. 2.3 L	2004	-	1998
VOLVO	S40	5 CIL. 2.4 L	2005	-	2008
VOLVO	S40	4 CIL. 1.9 L	2004	-	2000
VOLVO	C70	5 CIL. 2.4 L	2004	-	1999
VOLVO	S60	5 CIL. 2.3 L	2004	-	2001
VOLVO	C70	5 CIL. 2.3 L	2004	-	1998
VOLVO	S60	5 CIL. 2.4 L	2008	-	2001
VOLVO	XC70	5 CIL. 2.5 L	2004	-	2004
VOLVO	V70	5 CIL. 2.4 L	2007	-	1998
VOLVO	C30	5 CIL. 2.5 L	2008	-	2010
VOLVO	C30	5 CIL. 2.4 L	2008	-	2010
VOLVO	S60	5 CIL. 2.5 L	2007	-	2003
VOLVO	S40	5 CIL. 2.5 L	2007	-	2008
VOLVO	V70	5 CIL. 2.5 L	2007	-	2003
VOLVO	XC90	5 CIL. 2.5 L	2006	-	2003
VOLVO	S70	5 CIL. 2.3 L	2000	-	1998

**T43148**



DODGE	INTREPID	V6, 3.5 L	2004	-	2003
CHRYSLER	CONCORDE	V6, 3.5 L	2004	-	2003
CHRYSLER	PACIFICA	V6, 3.5 L	2004	-	2004
CHRYSLER	INTREPID	V6, 3.5 L (Canada)	2004	-	2003
CHRYSLER	300M	V6, 3.5 L	2004	-	2003

**T43157**



PEUGEOT	GRAND RAID	4 CIL. 1.6 L	2004	-	2008
PEUGEOT	PARTNER	4 CIL. 1.6 L	2006	-	2008

**T43159**

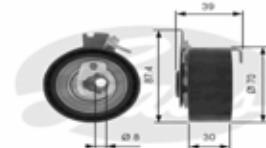

PEUGEOT	207	4 CIL. 1.6 L	2008	-	2009
---------	-----	--------------	------	---	------

**T43163**

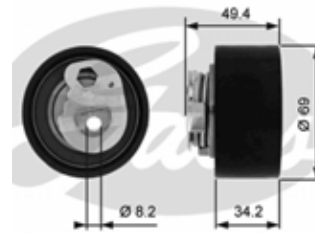

FIAT	DUCATO	4 CIL. 2.3 L DIESEL	2008	-	2008
------	--------	---------------------	------	---	------

**T43142**

Tipo de Resorte - Acero Lisa/Posterior (67mm x 8mm x 28.3mm)



SEAT	TOLEDO	4 CIL. 2.0 L	2006	-	2007
SEAT	LEON	4 CIL. 2.0 L	2006	-	2007
SEAT	ALTEA	4 CIL. 2.0 L	2006	-	2008

**T43166**



RENAULT	LAGUNA	V6, 2.4 L	2004 - 2006
---------	--------	-----------	-------------

**TMV13001**



FORD	IKON	4 CIL. 1.6 L	2007 - 2007
FORD	FIESTA	4 CIL. 1.6 L	2000 - 2010
FORD	KA	4 CIL. 1.6 L	2007 - 2006

**T43189**

Tipo Cilindro Hidráulico - Sin Polea



mitsubishi	OUTLANDER	V6, 3.0 L	2007 - 2008
------------	-----------	-----------	-------------

**TMV-13001**



FORD	IKON	4 CIL. 1.6 L	2000 - 2006
FORD	KA	4 CIL. 1.6 L	2001 - 2005

**T43190**

Tipo Cilindro Hidráulico - Sin Polea



mitsubishi	ECLIPSE	V6, 3.8 L	2007 - 2008
------------	---------	-----------	-------------

**TMV-14001**



**T43197**

Tipo Excéntrica - Acero Lisa/Posterior (62mm x 10mm x 35mm) - c/Tornillo, Rondana



CHRYSLER	TOWN & COUNTRY	V6, 4.0 L	2008 - 2010
DODGE	JOURNEY	V6, 3.5 L	2009 - 2010
CHRYSLER	300 C	V6, 3.5 L	2007 - 2009
DODGE	NITRO	V6, 4.0 L	2009 - 2010
DODGE	CHARGER	V6, 3.5 L	2009 - 2009

CHEVROLET	CORSA	4 CIL. 1.8 L	2003 - 2008
CHEVROLET	CORSA	4 CIL. 1.8 L	2009 - 2009
CHEVROLET	CORSA	4 CIL. 1.4 L	2002 - 2003
FIAT	PALIO	4 CIL. 1.8 L	2006 - 2008
CHEVROLET	ASTRA	4 CIL. 1.8 L	2000 - 2004
CHEVROLET	MERIVA	4 CIL. 1.8 L	2008 - 2008
CHEVROLET	ZAFIRA	4 CIL. 1.8 L	2000 - 2003
CHEVROLET	MERIVA	4 CIL. 1.8 L	2005 - 2007
FIAT	PALIO ADVENTURE	4 CIL. 1.8 L	2006 - 2008
CHEVROLET	TORNADO	4 CIL. 1.8 L	2003 - 2009

**TMV-22001**



VOLKSWAGEN	PANEL	4 CIL. 1.8 L	1998	-	2001
VOLKSWAGEN	POINTER PICK-UP	4 CIL. 1.8 L	1998	-	2005
VOLKSWAGEN	POINTER	4 CIL. 2.0 L	1998	-	2006
VOLKSWAGEN	POINTER	4 CIL. 1.8 L	1998	-	2005
VOLKSWAGEN	POINTER	4 CIL. 1.8 L	2006	-	2008

**TMV-22002**



VOLKSWAGEN	POINTER	4 CIL. 1.8 L	1998	-	2005
VOLKSWAGEN	POINTER PICK-UP	4 CIL. 1.8 L	1998	-	2005
VOLKSWAGEN	POINTER	4 CIL. 2.0 L	1998	-	2006
VOLKSWAGEN	PANEL	4 CIL. 1.8 L	1998	-	2001
VOLKSWAGEN	POINTER	4 CIL. 1.8 L	2006	-	2008

**TMV-23001**



VOLKSWAGEN	VW VAN	4 CIL. 1.6 L	2003	-	2006
SEAT	IBIZA	4 CIL. 1.6 L	2008	-	2007
VOLKSWAGEN	SPORTVAN	4 CIL. 1.6 L	2006	-	2008
VOLKSWAGEN	CROSSFOX	4 CIL. 1.6 L	2006	-	2008
VOLKSWAGEN	POLO	4 CIL. 1.6 L	2003	-	2005
VOLKSWAGEN	LUPO	4 CIL. 1.6 L	2004	-	2008

VOLKSWAGEN	POLO	4 CIL. 1.6 L	2006	-	2007
SEAT	CORDOBA	4 CIL. 1.6 L	2008	-	2007

**TPG-14001**



CHEVROLET	OPTRA	4 CIL. 2.0 L	2006	-	2010
CHEVROLET	ZAFIRA	4 CIL. 2.0 L	2004	-	2006
CHEVROLET	ASTRA	4 CIL. 2.0 L	2004	-	2006

**TPG-14002**



CHEVROLET	ASTRA	4 CIL. 2.4 L	2004	-	2006
CHEVROLET	ZAFIRA	4 CIL. 2.4 L	2004	-	2006

**TPG-14003**



CHEVROLET	CHEVY	4 CIL. 1.6 L	2005	-	2005
CHEVROLET	CHEVY	4 CIL. 1.6 L	2009	-	2010
CHEVROLET	MONZA	4 CIL. 1.6 L	1994	-	2004
CHEVROLET	CHEVY SWING	4 CIL. 1.6 L	1994	-	2003
CHEVROLET	CHEVY C2	4 CIL. 1.6 L	2004	-	2008
CHEVROLET	CHEVY POP	4 CIL. 1.6 L	1994	-	2003
CHEVROLET	CHEVY PICK-UP	4 CIL. 1.6 L	2002	-	2006
CHEVROLET	CHEVY C2 SEDAN	4 CIL. 1.6 L	2004	-	2008
CHEVROLET	CHEVY JOY	4 CIL. 1.6 L	1994	-	2003

**TPG-14004**



CHEVROLET	CORSA	4 CIL. 1.8 L	2006 - 2008
CHEVROLET	TORNADO	4 CIL. 1.8 L	2003 - 2007
CHEVROLET	CORSA	4 CIL. 1.4 L	2002 - 2002
CHEVROLET	CORSA	4 CIL. 1.4 L	2003 - 2003
CHEVROLET	CORSA	4 CIL. 1.8 L	2009 - 2009
FIAT	PALIO ADVENTURE	4 CIL. 1.8 L	2006 - 2008
FIAT	PALIO	4 CIL. 1.8 L	2006 - 2008
CHEVROLET	ZAFIRA	4 CIL. 1.8 L	2000 - 2003
CHEVROLET	MERIVA	4 CIL. 1.8 L	2005 - 2007
CHEVROLET	CORSA	4 CIL. 1.8 L	2003 - 2005
CHEVROLET	TORNADO	4 CIL. 1.8 L	2008 - 2009
CHEVROLET	MERIVA	4 CIL. 1.8 L	2008 - 2008
CHEVROLET	ASTRA	4 CIL. 1.8 L	2000 - 2004

**TPG-22001**



VOLKSWAGEN	EUROVAN	5 CIL. 2.5 L	2001 - 2002
------------	---------	--------------	-------------

**TPG-23001**



VOLKSWAGEN	LUPO	4 CIL. 1.6 L	2004 - 2006
VOLKSWAGEN	LUPO	4 CIL. 1.6 L	2007 - 2008
VOLKSWAGEN	POLO	4 CIL. 1.6 L	2006 - 2007
VOLKSWAGEN	GOL	4 CIL. 1.6 L	2009 - 2010
VOLKSWAGEN	POLO	4 CIL. 1.6 L	2003 - 2005
VOLKSWAGEN	SAVEIRO	4 CIL. 1.6 L	2010 - 2010
SEAT	IBIZA	4 CIL. 1.6 L	2003 - 2009
SEAT	CORDOBA	4 CIL. 1.6 L	2003 - 2007
VOLKSWAGEN	VW VAN	4 CIL. 1.6 L	2003 - 2005

**TPG-20001**



RENAULT	CLIO	4 CIL. 2.0 L SPORT	2003 - 2006
RENAULT	MEGANE	4 CIL. 2.0 L	2009 - 2009
RENAULT	LAGUNA	4 CIL. 2.0 L	2001 - 2004
RENAULT	SCENIC	4 CIL. 2.0 L	2001 - 2007
RENAULT	SCENIC	4 CIL. 2.0 L	2009 - 2009
RENAULT	MEGANE	4 CIL. 2.0 L	2001 - 2008





# ***Aplicación por producto Servicio Pesado***



***La marca de más prestigio en bandas, mangueras, hidráulica y neumática***

Tensores y Poleas

36091



INTERNATIONAL/NAVISTAR	8600	Cummins ISM Diesel	2003 - 2007
KENWORTH	T600	Caterpillar C15 Diesel	2006 - 2006
INTERNATIONAL/NAVISTAR	9400	Caterpillar 3176 Diesel	1995 - 1995
INTERNATIONAL/NAVISTAR	9300	Caterpillar 3176 Diesel	1995 - 1995
INTERNATIONAL/NAVISTAR	9200i	Cummins ISM Diesel	2003 - 2007
INTERNATIONAL/NAVISTAR	9200i	Caterpillar C12 Diesel	2004 - 2004
INTERNATIONAL/NAVISTAR	9200i	Caterpillar C12 Diesel	2004 - 2004
INTERNATIONAL/NAVISTAR	9200i	Caterpillar C12 Diesel	2003 - 2004
INTERNATIONAL/NAVISTAR	9200i	Caterpillar C10 Diesel	2004 - 2004
INTERNATIONAL/NAVISTAR	9200i	Caterpillar C10 Diesel	2004 - 2004
INTERNATIONAL/NAVISTAR	9400i	Caterpillar C15 Diesel	2004 - 2007
INTERNATIONAL/NAVISTAR	9200	Caterpillar 3176 Diesel	1995 - 1995
INTERNATIONAL/NAVISTAR	9400i	Cummins ISM Diesel	2004 - 2007
INTERNATIONAL/NAVISTAR	8600	Caterpillar C12 Diesel	2003 - 2004
INTERNATIONAL/NAVISTAR	8600	Caterpillar C12 Diesel	2003 - 2004
INTERNATIONAL/NAVISTAR	8600	Caterpillar C12 Diesel	2003 - 2004
INTERNATIONAL/NAVISTAR	8600	Caterpillar C10 Diesel	2003 - 2004
INTERNATIONAL/NAVISTAR	8600	Caterpillar C10 Diesel	2003 - 2004
INTERNATIONAL/NAVISTAR	8600	Caterpillar C10 Diesel	2003 - 2004
INTERNATIONAL/NAVISTAR	8500	International/Navistar 530 Diesel	2002 - 2005
INTERNATIONAL/NAVISTAR	8500	International/Navistar 530 Diesel	2002 - 2005
INTERNATIONAL/NAVISTAR	8200	International/Navistar DT466 Diesel	1997 - 1997
INTERNATIONAL/NAVISTAR	9200i	Caterpillar C10 Diesel	2004 - 2004
INTERNATIONAL/NAVISTAR	WORKSTAR 7600	Cummins ISM Diesel	2008 - 2008
INTERNATIONAL/NAVISTAR	5600i	Caterpillar C15 Diesel	2004 - 2004
KENWORTH	T600	Caterpillar C12 Diesel	1996 - 2004
KENWORTH	T600	Caterpillar C12 Diesel	1996 - 2004
KENWORTH	T600	Caterpillar C10 Diesel	1997 - 2004
KENWORTH	T600	Caterpillar C10 Diesel	1997 - 2004
KENWORTH	T300	Caterpillar C7 Diesel	2004 - 2006
KENWORTH	T300	Caterpillar 3126 Diesel	1996 - 2003
KENWORTH	T2000	Caterpillar C15 Diesel	2004 - 2007

KENWORTH	T2000	Caterpillar C15 Diesel	2004 - 2007
INTERNATIONAL/NAVISTAR	9400i	Caterpillar C15 Diesel	2004 - 2007
KENWORTH	T2000	Caterpillar C10 Diesel	1997 - 1999
INTERNATIONAL/NAVISTAR	8200	International/Navistar 530 Diesel	1996 - 1997
INTERNATIONAL/NAVISTAR	TRANSTAR 8600	Cummins ISM Diesel	2008 - 2008
INTERNATIONAL/NAVISTAR	PAYSTAR 5600i	Caterpillar C15 Diesel	2008 - 2008
INTERNATIONAL/NAVISTAR	PAYSTAR 5600i	Caterpillar C15 Diesel	2008 - 2008
INTERNATIONAL/NAVISTAR	9900ix	Caterpillar C15 Diesel	2004 - 2007
INTERNATIONAL/NAVISTAR	9900ix	Caterpillar C15 Diesel	2004 - 2007
INTERNATIONAL/NAVISTAR	9900ix	Caterpillar C12 Diesel	2003 - 2003
INTERNATIONAL/NAVISTAR	9900i	Caterpillar C15 Diesel	2004 - 2007
INTERNATIONAL/NAVISTAR	9900i	Caterpillar C15 Diesel	2004 - 2007
INTERNATIONAL/NAVISTAR	9900i	Caterpillar C12 Diesel	2003 - 2004
KENWORTH	T2000	Caterpillar C12 Diesel	1997 - 1999
INTERNATIONAL/NAVISTAR	7100	International/Navistar DT466 Diesel	1995 - 1995
INTERNATIONAL/NAVISTAR	7500	International/Navistar DT466 Diesel	2002 - 2002
INTERNATIONAL/NAVISTAR	7500	International/Navistar 530 Diesel	2002 - 2003
INTERNATIONAL/NAVISTAR	7500	International/Navistar 530 Diesel	2002 - 2003
INTERNATIONAL/NAVISTAR	7400	International/Navistar DT530 Diesel	2004 - 2005
INTERNATIONAL/NAVISTAR	7400	International/Navistar DT466 Diesel	2002 - 2003
INTERNATIONAL/NAVISTAR	7400	International/Navistar 530 Diesel	2002 - 2003
INTERNATIONAL/NAVISTAR	7400	International/Navistar 530 Diesel	2002 - 2003
INTERNATIONAL/NAVISTAR	7400	Cummins ISM Diesel	2005 - 2005
INTERNATIONAL/NAVISTAR	7300	International/Navistar DT466 Diesel	2002 - 2003
INTERNATIONAL/NAVISTAR	8200	International/Navistar DT466 Diesel	1997 - 1997
INTERNATIONAL/NAVISTAR	7100	International/Navistar DT466 Diesel	1995 - 1995
INTERNATIONAL/NAVISTAR	7500	International/Navistar DT530 Diesel	2004 - 2005
INTERNATIONAL/NAVISTAR	5900i	Cummins ISM Diesel	2001 - 2006
INTERNATIONAL/NAVISTAR	5900i	Caterpillar C15 Diesel	2004 - 2006
INTERNATIONAL/NAVISTAR	5900i	Caterpillar C12 Diesel	2002 - 2004
INTERNATIONAL/NAVISTAR	5900i	Caterpillar C12 Diesel	2002 - 2004
INTERNATIONAL/NAVISTAR	5900i	Caterpillar C10 Diesel	2000 - 2003
INTERNATIONAL/NAVISTAR	5900i	Caterpillar C10 Diesel	2002 - 2003
INTERNATIONAL/NAVISTAR	5600i	International/Navistar DT466 Diesel	2001 - 2002
INTERNATIONAL/NAVISTAR	5600i	International/Navistar DT466 Diesel	2001 - 2002
INTERNATIONAL/NAVISTAR	5600i	Cummins ISM Diesel	2002 - 2007
INTERNATIONAL/NAVISTAR	7300	International/Navistar DT466 Diesel	2002 - 2003
INTERNATIONAL/NAVISTAR	8100	Caterpillar 3176 Diesel	1995 - 1995
KENWORTH	T600	Caterpillar C15 Diesel	2005 - 2006
INTERNATIONAL/NAVISTAR	8200	Detroit Diesel 6-Cyl. 12.7 L Diesel	1995 - 1995
INTERNATIONAL/NAVISTAR	8200	Detroit Diesel 6-Cyl. 11.1 L Diesel	1995 - 1995

INTERNATIONAL/NAVISTAR	8100	International/Navistar DT466 Diesel	1995 - 2000
INTERNATIONAL/NAVISTAR	8100	International/Navistar DT466 Diesel	1995 - 2000
INTERNATIONAL/NAVISTAR	8100	International/Navistar 530 Diesel	1995 - 2003
INTERNATIONAL/NAVISTAR	8100	International/Navistar 530 Diesel	1999 - 2003
INTERNATIONAL/NAVISTAR	8100	International/Navistar 530 Diesel	1995 - 1997
INTERNATIONAL/NAVISTAR	8100	Caterpillar C10 Diesel	2002 - 2003
INTERNATIONAL/NAVISTAR	7500	International/Navistar DT466 Diesel	2002 - 2002
INTERNATIONAL/NAVISTAR	8100	Caterpillar C10 Diesel	2002 - 2003
INTERNATIONAL/NAVISTAR	7500	International/Navistar DT530 Diesel	2004 - 2005
INTERNATIONAL/NAVISTAR	8100	Caterpillar 3176 Diesel	1996 - 1997
INTERNATIONAL/NAVISTAR	7700	Cummins ISM Diesel	2005 - 2006
INTERNATIONAL/NAVISTAR	7600	Cummins ISM Diesel	2003 - 2007
INTERNATIONAL/NAVISTAR	7600	Caterpillar C12 Diesel	2002 - 2003
INTERNATIONAL/NAVISTAR	7600	Caterpillar C12 Diesel	2002 - 2004
INTERNATIONAL/NAVISTAR	7600	Caterpillar C12 Diesel	2002 - 2004
INTERNATIONAL/NAVISTAR	7600	Caterpillar C10 Diesel	2002 - 2003
INTERNATIONAL/NAVISTAR	7600	Caterpillar C10 Diesel	2002 - 2004
INTERNATIONAL/NAVISTAR	7600	Caterpillar C10 Diesel	2002 - 2004
INTERNATIONAL/NAVISTAR	8200	International/Navistar 530 Diesel	1996 - 1997
INTERNATIONAL/NAVISTAR	8100	Caterpillar C10 Diesel	2002 - 2003
PETERBILT	387	Caterpillar C10 Diesel	2000 - 2002
KENWORTH	T600	Caterpillar C15 Diesel	2000 - 2007
PETERBILT	388	Caterpillar C15 Diesel	2007 - 2007
PETERBILT	387	Cummins ISM Diesel	2000 - 2000
PETERBILT	387	Caterpillar C16 Diesel	2001 - 2003
PETERBILT	387	Caterpillar C16 Diesel	2001 - 2003
PETERBILT	387	Caterpillar C15 Diesel	2001 - 2007
PETERBILT	387	Caterpillar C15 Diesel	2001 - 2003
PETERBILT	387	Caterpillar C15 Diesel	2004 - 2007
PETERBILT	387	Caterpillar C12 Diesel	2000 - 2002
STERLING	ACTERRA	Caterpillar 3126 Diesel	2001 - 2004
PETERBILT	387	Caterpillar C10 Diesel	2000 - 2002
STERLING	ACTERRA	Caterpillar C7 Diesel	2004 - 2007
PETERBILT	386	Caterpillar C15 Diesel	2006 - 2007
PETERBILT	385	Cummins ISM Diesel	2002 - 2005
PETERBILT	385	Caterpillar C12 Diesel	1996 - 2004
PETERBILT	385	Caterpillar C10 Diesel	1997 - 2004
PETERBILT	379	Caterpillar C15 Diesel	2004 - 2004
PETERBILT	379	Caterpillar C15 Diesel	2005 - 2005
PETERBILT	379	Caterpillar C15 Diesel	2006 - 2007
PETERBILT	379	Caterpillar C15 Diesel	2004 - 2007

PETERBILT	379	Caterpillar C12 Diesel	2002 - 2004
PETERBILT	387	Caterpillar C12 Diesel	2000 - 2002
STERLING	L-LINE	Caterpillar 3126 Diesel	2000 - 2004
BLUEBIRD	ALL AMERICAN RE	Caterpillar 3126 Diesel	2003 - 2004
VOLVO	VN SERIES	Detroit Diesel 6-Cyl. 12.7 L Diesel	1998 - 2001
VOLVO	VN SERIES	Detroit Diesel 6-Cyl. 11.1 L Diesel	1998 - 2001
VOLVO	VN SERIES	Caterpillar 3406 Diesel	1999 - 1999
VOLVO	AUTOCAR	Detroit Diesel 6-Cyl. 12.7 L Diesel	1998 - 1998
VOLVO	AUTOCAR	Detroit Diesel 6-Cyl. 11.1 L Diesel	1998 - 1998
STERLING	L-LINE	Cummins ISC Diesel	2000 - 2003
STERLING	L-LINE	Caterpillar C9 Diesel	2006 - 2006
STERLING	L-LINE	Caterpillar C7 Diesel	2004 - 2004
STERLING	ACTERRA	CATERPILLAR 3126 DIESEL	2003 - 2003
STERLING	L-LINE	Caterpillar C15 Diesel	2004 - 2007
PETERBILT	379	Caterpillar C10 Diesel	2000 - 2000
STERLING	L-LINE	CATERPILLAR 3126 DIESEL	2001 - 2002
STERLING	L-LINE	CATERPILLAR 3126 DIESEL	2003 - 2003
STERLING	A-LINE	Caterpillar C15 Diesel	2004 - 2007
STERLING	A-LINE	Caterpillar C12 Diesel	2002 - 2004
STERLING	A-LINE	Caterpillar C12 Diesel	2002 - 2004
STERLING	A-LINE	Caterpillar C12 Diesel	2002 - 2004
STERLING	A-LINE	Caterpillar C12 Diesel	2002 - 2004
STERLING	A-LINE	Caterpillar C10 Diesel	2002 - 2004
STERLING	A-LINE	Caterpillar C10 Diesel	2002 - 2004
STERLING	A-LINE	Caterpillar C10 Diesel	2002 - 2004
STERLING	A-LINE	Caterpillar C10 Diesel	2002 - 2004
STERLING	L-LINE	Caterpillar C7 Diesel	2005 - 2007
KENWORTH	T800	Caterpillar C15 Diesel	2004 - 2007
PETERBILT	330	Caterpillar 3126 Diesel	1998 - 2003
PETERBILT	320	Cummins ISM Diesel	2007 - 2007
PETERBILT	320	Caterpillar C7 Diesel	2004 - 2007
KENWORTH	W900	Cummins ISM Diesel	2003 - 2006
KENWORTH	W900	Caterpillar C15 Diesel	2004 - 2007
KENWORTH	W900	Caterpillar C15 Diesel	2004 - 2008
KENWORTH	W900	Caterpillar C12 Diesel	2000 - 2004
KENWORTH	W900	Caterpillar C10 Diesel	1998 - 1997
KENWORTH	T800	Cummins ISM Diesel	2003 - 2006
PETERBILT	379	Caterpillar C12 Diesel	2000 - 2000
KENWORTH	T800	Caterpillar C15 Diesel	2004 - 2004
PETERBILT	357	Caterpillar C10 Diesel	1997 - 2004
KENWORTH	T800	Caterpillar C12 Diesel	1996 - 2004
KENWORTH	T800	Caterpillar C12 Diesel	2003 - 2003
KENWORTH	T800	Caterpillar C12 Diesel	1996 - 2004



KENWORTH	T800	Caterpillar C10 Diesel	1997 - 2004
KENWORTH	T800	Caterpillar C10 Diesel	2003 - 2003
KENWORTH	T800	Caterpillar C10 Diesel	1997 - 2004
KENWORTH	T660	Caterpillar C15 Diesel	2007 - 2007
KENWORTH	T600	Cummins ISM Diesel	2006 - 2008
KENWORTH	T600	Caterpillar C15 Diesel	2000 - 2004
KENWORTH	T800	Caterpillar C15 Diesel	2004 - 2004
PETERBILT	377	Caterpillar C10 Diesel	1997 - 1998
INTERNATIONAL/NAVISTAR	7400	International/Navistar DT466 Diesel	2002 - 2003
PETERBILT	378	Cummins ISM Diesel	2001 - 2007
PETERBILT	378	Caterpillar C15 Diesel	2003 - 2004
PETERBILT	378	Caterpillar C15 Diesel	2006 - 2006
PETERBILT	378	Caterpillar C15 Diesel	2005 - 2007
PETERBILT	378	Caterpillar C15 Diesel	2004 - 2007
PETERBILT	378	Caterpillar C12 Diesel	2002 - 2004
PETERBILT	378	Caterpillar C12 Diesel	2000 - 2002
PETERBILT	378	Caterpillar C10 Diesel	2002 - 2004
PETERBILT	330	Caterpillar C7 Diesel	2004 - 2007
PETERBILT	377	Caterpillar C12 Diesel	1997 - 1998
PETERBILT	335	Caterpillar C7 Diesel	2005 - 2007
PETERBILT	365	Cummins ISM Diesel	2007 - 2007
PETERBILT	362	Caterpillar C12 Diesel	1996 - 1998
PETERBILT	362	Caterpillar C10 Diesel	1996 - 1998
PETERBILT	357	Cummins ISM Diesel	2003 - 2007
PETERBILT	357	Cummins ISC Diesel	2001 - 2001
PETERBILT	357	Caterpillar C15 Diesel	2006 - 2006
PETERBILT	357	Caterpillar C15 Diesel	2004 - 2007
PETERBILT	357	Caterpillar C15 Diesel	2004 - 2007
PETERBILT	357	Caterpillar C12 Diesel	1997 - 2004
PETERBILT	379	Caterpillar C10 Diesel	2002 - 2004
PETERBILT	378	Caterpillar C10 Diesel	2000 - 2002
FREIGHTLINER	CENTURY CLASS	Caterpillar C12 Diesel	1998 - 2002
FREIGHTLINER	CLASSIC	Caterpillar C15 Diesel	2001 - 2006
FREIGHTLINER	CLASSIC	Caterpillar C15 Diesel	2004 - 2007
FREIGHTLINER	CLASSIC	Caterpillar C12 Diesel	2001 - 2004
FREIGHTLINER	CLASSIC	Caterpillar C10 Diesel	2001 - 2003
FREIGHTLINER	CENTURY CLASS	Cummins ISM Diesel	1998 - 1998
FREIGHTLINER	CENTURY CLASS	Cummins ISM Diesel	1999 - 2001
FREIGHTLINER	CENTURY CLASS	Caterpillar C15 Diesel	2001 - 2006
FREIGHTLINER	CENTURY CLASS	Caterpillar C15 Diesel	2001 - 2004
FREIGHTLINER	CENTURY CLASS	Caterpillar C15 Diesel	2004 - 2007

FREIGHTLINER	ARGOSY	Caterpillar C15 Diesel	2003 - 2002
FREIGHTLINER	CENTURY CLASS	Caterpillar C12 Diesel	2001 - 2004
FREIGHTLINER	CLASSIC	Caterpillar C16 Diesel	2001 - 2003
FREIGHTLINER	CENTURY CLASS	Caterpillar C12 Diesel	1999 - 2004
FREIGHTLINER	CENTURY CLASS	Caterpillar C10 Diesel	2000 - 2000
FREIGHTLINER	CENTURY CLASS	Caterpillar C10 Diesel	2001 - 2003
FREIGHTLINER	CENTURY CLASS	Caterpillar C10 Diesel	1998 - 2002
FREIGHTLINER	CENTURY CLASS	Caterpillar C10 Diesel	1999 - 2003
FREIGHTLINER	CENTURY CLASS	Caterpillar 3406 Diesel	1998 - 1999
FREIGHTLINER	CENTURY CLASS	Caterpillar 3406 Diesel	1998 - 1999
FREIGHTLINER	BUSINESS CLASS M2	Caterpillar C7 Diesel	2004 - 2007
FREIGHTLINER	CONDOR	Caterpillar C10 Diesel	2001 - 2004
FREIGHTLINER	CENTURY CLASS	Caterpillar C12 Diesel	2000 - 2000
FREIGHTLINER	COLUMBIA	Caterpillar C10 Diesel	2001 - 2003
FREIGHTLINER	COLUMBIA	Cummins ISM Diesel	2001 - 2003
FREIGHTLINER	COLUMBIA	Caterpillar C16 Diesel	2001 - 2004
FREIGHTLINER	COLUMBIA	Caterpillar C16 Diesel	2001 - 2004
FREIGHTLINER	COLUMBIA	Caterpillar C15 Diesel	2001 - 2005
FREIGHTLINER	COLUMBIA	Caterpillar C15 Diesel	2001 - 2003
FREIGHTLINER	COLUMBIA	Caterpillar C15 Diesel	2004 - 2008
FREIGHTLINER	COLUMBIA	Caterpillar C12 Diesel	2003 - 2004
FREIGHTLINER	COLUMBIA	Caterpillar C12 Diesel	2003 - 2004
FREIGHTLINER	COLUMBIA	Caterpillar C12 Diesel	2001 - 2004
FREIGHTLINER	CLASSIC	Caterpillar C15 Diesel	2001 - 2006
FREIGHTLINER	COLUMBIA	Caterpillar C10 Diesel	2001 - 2003
FREIGHTLINER	CLASSIC	Caterpillar C16 Diesel	2001 - 2003
FREIGHTLINER	CLASSIC XL	Cummins ISM Diesel	2001 - 2003
FREIGHTLINER	CLASSIC XL	Caterpillar C16 Diesel	2001 - 2003
FREIGHTLINER	CLASSIC XL	Caterpillar C16 Diesel	2001 - 2003
FREIGHTLINER	CLASSIC XL	Caterpillar C15 Diesel	2001 - 2006
INTERNATIONAL/NAVISTAR	5600i	Caterpillar C12 Diesel	2003 - 2004
FREIGHTLINER	CLASSIC XL	Caterpillar C15 Diesel	2004 - 2007
INTERNATIONAL/NAVISTAR	7400	International/Navistar DT530 Diesel	2004 - 2005
FREIGHTLINER	CLASSIC XL	Caterpillar C10 Diesel	2001 - 2003
FREIGHTLINER	CLASSIC	Cummins ISM Diesel	2001 - 2003
FREIGHTLINER	ARGOSY	Caterpillar C15 Diesel	2003 - 2002
FREIGHTLINER	COLUMBIA	Caterpillar C10 Diesel	2001 - 2003
INTERNATIONAL/NAVISTAR	3800	International/Navistar DT466 Diesel	2000 - 2001
THOMAS BUILT	SAF-T-LINER MVP ER	Cummins ISC Diesel	1998 - 1998
THOMAS BUILT	SAF-T-LINER MVP ER	Caterpillar 3126 Diesel	2001 - 2003
THOMAS BUILT	SAF-T-LINER MVP ER	Caterpillar 3126 Diesel	2004 - 2004



THOMAS BUILT	SAF-T-LINER MVP EF	Cummins ISB Diesel	2000 - 2002
THOMAS BUILT	SAF-T-LINER MVP EF	Caterpillar 3126 Diesel	1998 - 2004
THOMAS BUILT	SAF-T-LINER C2	Caterpillar C7 Diesel	2008 - 2008
THOMAS BUILT	CONVENTIONAL	Caterpillar 3126 Diesel	1998 - 2003
INTERNATIONAL/NAVISTAR	RE	International/Navistar 530 Diesel	1998 - 2004
INTERNATIONAL/NAVISTAR	FE	International/Navistar DT466 Diesel	2002 - 2004
FREIGHTLINER	BUSINESS CLASS M2	Caterpillar 3126 Diesel	2007 - 2007
INTERNATIONAL/NAVISTAR	CE	International/Navistar DT466 Diesel	2003 - 2004
THOMAS BUILT	SAF-T-LINER MVP ER	John Deere 6-Cyl. 8.1 L CNG	2001 - 2001
INTERNATIONAL/NAVISTAR	3800	International/Navistar DT466 Diesel	1998 - 1999
INTERNATIONAL/NAVISTAR	3300	International/Navistar DT466 Diesel	2004 - 2004
BLUEBIRD	TC2000	Caterpillar 3126 Diesel	1998 - 1998
BLUEBIRD	CONVENTIONAL	International/Navistar DT466 Diesel	1999 - 2004
BLUEBIRD	ALL AMERICAN RE	John Deere 6-Cyl. 8.1 L CNG	2003 - 2003
BLUEBIRD	ALL AMERICAN RE	John Deere 6-Cyl. 8.1 L CNG	2000 - 2002
BLUEBIRD	ALL AMERICAN RE	Cummins ISC Diesel	1998 - 1998
BLUEBIRD	ALL AMERICAN RE	Cummins ISC Diesel	1999 - 2000
BLUEBIRD	ALL AMERICAN RE	Caterpillar C7 Diesel	2005 - 2006
INTERNATIONAL/NAVISTAR	CONVENTIONAL IC	International/Navistar DT466 Diesel	2002 - 2003
CHEVROLET	KODIAK	CATERPILLAR 3126 DIESEL	2000 - 2008
FREIGHTLINER	ARGOSY	Caterpillar C12 Diesel	2003 - 2002
FREIGHTLINER	ARGOSY	Caterpillar C12 Diesel	2003 - 2002
FREIGHTLINER	ARGOSY	Caterpillar C12 Diesel	2004 - 2003
FREIGHTLINER	ARGOSY	Caterpillar C10 Diesel	2003 - 2002
FREIGHTLINER	ARGOSY	Caterpillar C10 Diesel	2003 - 2002
FORD	F750 SUPER DUTY	Caterpillar 3126 Diesel	2000 - 2004
FORD	F650 SUPER DUTY	Caterpillar 3126 Diesel	2000 - 2004
CHEVROLET	KODIAK C8500	Caterpillar 3116 Diesel	1991 - 1996
THOMAS BUILT	SAF-T-LINER MVP ER	John Deere 6-Cyl. 8.1 L CNG	2002 - 2002
CHEVROLET	KODIAK C6500	Caterpillar 3116 Diesel	1991 - 1996
THOMAS BUILT	SAF-T-LINER MVP ER	John Deere 6-Cyl. 8.1 L CNG	2003 - 2003
CHEVROLET	KODIAK	CATERPILLAR 3116 DIESEL	1997 - 2000
CHEVROLET	C8500	Caterpillar 3126 Diesel	1998 - 2003
CHEVROLET	C8500	Caterpillar 3116 Diesel	1997 - 2000
CHEVROLET	C7500	Caterpillar 3126 Diesel	1998 - 2003
CHEVROLET	C7500	Caterpillar 3116 Diesel	1997 - 2000
CHEVROLET	C6500	Caterpillar 3126 Diesel	1998 - 2003
CHEVROLET	C6500	Caterpillar 3116 Diesel	1997 - 2000
CHEVROLET	C5500	Caterpillar 3126 Diesel	1998 - 2002
CHEVROLET	C5500	Caterpillar 3116 Diesel	1999 - 1999

FREIGHTLINER	CLASSIC XL	Caterpillar C15 Diesel	2001 - 2006
CHEVROLET	KODIAK C7500	Caterpillar 3116 Diesel	1991 - 1996
INTERNATIONAL/NAVISTAR	4400	International/Navistar 530 Diesel	2002 - 2005
FREIGHTLINER	FLD	Caterpillar C12 Diesel	2000 - 2000
FREIGHTLINER	CLASSIC XL	Caterpillar C12 Diesel	2001 - 2003
INTERNATIONAL/NAVISTAR	4700	International/Navistar DT466 Diesel	1995 - 2002
FREIGHTLINER	CONDOR	Caterpillar C10 Diesel	2001 - 2004
INTERNATIONAL/NAVISTAR	4700	International/Navistar DT408 Diesel	1995 - 1997
INTERNATIONAL/NAVISTAR	4700	International/Navistar DT408 Diesel	1995 - 1997
INTERNATIONAL/NAVISTAR	4700	International/Navistar 530 Diesel	1999 - 2002
INTERNATIONAL/NAVISTAR	4700	International/Navistar 530 Diesel	1999 - 2002
INTERNATIONAL/NAVISTAR	4400	International/Navistar DT466 Diesel	2002 - 2005
INTERNATIONAL/NAVISTAR	4800	International/Navistar 530 Diesel	2002 - 2002
INTERNATIONAL/NAVISTAR	4400	International/Navistar 530 Diesel	2002 - 2005
INTERNATIONAL/NAVISTAR	4800	International/Navistar DT408 Diesel	1995 - 1997
INTERNATIONAL/NAVISTAR	4300	International/Navistar DT466 Diesel	2002 - 2004
INTERNATIONAL/NAVISTAR	4300	International/Navistar DT466 Diesel	2002 - 2004
FREIGHTLINER	FLD	Cummins ISX Diesel	2001 - 2001
FREIGHTLINER	FLD	Cummins ISM Diesel	1999 - 2003
FREIGHTLINER	FLD	Caterpillar C16 Diesel	2000 - 2004
FREIGHTLINER	FLD	Caterpillar C16 Diesel	2000 - 2004
FREIGHTLINER	FLD	Caterpillar C15 Diesel	2000 - 2008
FREIGHTLINER	FLD	Caterpillar C15 Diesel	2000 - 2004
FREIGHTLINER	FLD	Caterpillar C15 Diesel	2004 - 2008
INTERNATIONAL/NAVISTAR	4400	International/Navistar DT466 Diesel	2002 - 2005
INTERNATIONAL/NAVISTAR	4900	International/Navistar DT466 Diesel	1995 - 2002
INTERNATIONAL/NAVISTAR	5600i	Caterpillar C12 Diesel	2003 - 2004
INTERNATIONAL/NAVISTAR	5600i	Caterpillar C10 Diesel	2002 - 2004
INTERNATIONAL/NAVISTAR	5600i	Caterpillar C10 Diesel	2002 - 2004
INTERNATIONAL/NAVISTAR	5500i	International/Navistar DT466 Diesel	2001 - 2002
INTERNATIONAL/NAVISTAR	5500i	International/Navistar DT466 Diesel	2001 - 2002
INTERNATIONAL/NAVISTAR	5500i	Cummins ISM Diesel	2002 - 2006
INTERNATIONAL/NAVISTAR	5500i	Caterpillar C12 Diesel	2003 - 2004
INTERNATIONAL/NAVISTAR	5500i	Caterpillar C12 Diesel	2003 - 2004
INTERNATIONAL/NAVISTAR	5500i	Caterpillar C10 Diesel	2003 - 2004
INTERNATIONAL/NAVISTAR	4800	International/Navistar 530 Diesel	2002 - 2002
INTERNATIONAL/NAVISTAR	5000	Caterpillar C12 Diesel	1998 - 1999
INTERNATIONAL/NAVISTAR	4700	International/Navistar DT466 Diesel	2000 - 2002
INTERNATIONAL/NAVISTAR	4900	International/Navistar DT466 Diesel	1995 - 2002
INTERNATIONAL/NAVISTAR	4900	International/Navistar DT466 Diesel	2000 - 2001
INTERNATIONAL/NAVISTAR	4900	International/Navistar DT408 Diesel	1995 - 1997

INTERNATIONAL/NAVISTAR	4900	International/Navistar DT408 Diesel	1995 - 1997
INTERNATIONAL/NAVISTAR	4900	International/Navistar 530 Diesel	1995 - 2002
INTERNATIONAL/NAVISTAR	4900	International/Navistar 530 Diesel	1995 - 2002
INTERNATIONAL/NAVISTAR	4800	International/Navistar DT466 Diesel	1995 - 2003
INTERNATIONAL/NAVISTAR	4800	International/Navistar DT466 Diesel	1995 - 2003
INTERNATIONAL/NAVISTAR	4800	International/Navistar DT408 Diesel	1995 - 1997
INTERNATIONAL/NAVISTAR	5500i	Caterpillar C10 Diesel	2003 - 2004
FREIGHTLINER	CORONADO	Caterpillar C16 Diesel	2002 - 2003
FREIGHTLINER	FL50	Caterpillar 3126 Diesel	1995 - 2004
FREIGHTLINER	FL112	Cummins ISM Diesel	1999 - 2003
FREIGHTLINER	FL112	Caterpillar C12 Diesel	2000 - 2004
FREIGHTLINER	FL112	Caterpillar C12 Diesel	2001 - 2004
FREIGHTLINER	FL112	Caterpillar C12 Diesel	1999 - 1999
FREIGHTLINER	FL112	Caterpillar C12 Diesel	1999 - 2004
FREIGHTLINER	FL112	Caterpillar C10 Diesel	2000 - 2004
FREIGHTLINER	FL112	Caterpillar C10 Diesel	2001 - 2004
FREIGHTLINER	FL112	Caterpillar C10 Diesel	1999 - 1999
FREIGHTLINER	FL50	Caterpillar C7 Diesel	2004 - 2004
FREIGHTLINER	CORONADO	Caterpillar C16 Diesel	2002 - 2003
FREIGHTLINER	CONDOR	Cummins ISM Diesel	2001 - 2002
FREIGHTLINER	CORONADO	Caterpillar C15 Diesel	2002 - 2006
FREIGHTLINER	CORONADO	Caterpillar C15 Diesel	2002 - 2004
FREIGHTLINER	CORONADO	Caterpillar C15 Diesel	2004 - 2007
FREIGHTLINER	FLD	Caterpillar C12 Diesel	2001 - 2004
FREIGHTLINER	CONDOR	Caterpillar C7 Diesel	2005 - 2005
INTERNATIONAL/NAVISTAR	4700	International/Navistar DT466 Diesel	1995 - 1999
FREIGHTLINER	CONDOR	Caterpillar C12 Diesel	2001 - 2004
FREIGHTLINER	CONDOR	Caterpillar C12 Diesel	2001 - 2004
FREIGHTLINER	CONDOR	Caterpillar C10 Diesel	2001 - 2004
FREIGHTLINER	FL112	Caterpillar C10 Diesel	1999 - 2004
FREIGHTLINER	FLD	Caterpillar C10 Diesel	1997 - 2002
FREIGHTLINER	CONDOR	Caterpillar C12 Diesel	2001 - 2004
FREIGHTLINER	FL50	Cummins ISC Diesel	1998 - 1998
FREIGHTLINER	FLD	Caterpillar C12 Diesel	1996 - 2002
FREIGHTLINER	FLD	Caterpillar C12 Diesel	1999 - 2004
FREIGHTLINER	FLD	Caterpillar C10 Diesel	2001 - 2004
FREIGHTLINER	FLD	Caterpillar C10 Diesel	1999 - 2004
FREIGHTLINER	FLD	Caterpillar 3406 Diesel	1998 - 2000
FREIGHTLINER	FLD	Caterpillar 3406 Diesel	1998 - 2000
FREIGHTLINER	FL80	Cummins ISC Diesel	1999 - 1999
FREIGHTLINER	FL80	Cummins ISC Diesel	1998 - 1998

FREIGHTLINER	FL80	Cummins C Series 8.3 L Diesel	1997 - 1997
FREIGHTLINER	FL80	Caterpillar C7 Diesel	2004 - 2005
FREIGHTLINER	FL60	Caterpillar C7 Diesel	2004 - 2005
FREIGHTLINER	FL80	Caterpillar 3126 Diesel	1995 - 2005
FREIGHTLINER	FL70	Cummins ISC Diesel	1998 - 1998
FREIGHTLINER	FL70	Caterpillar C7 Diesel	2004 - 2005
FREIGHTLINER	FL70	Caterpillar C7 Diesel	2004 - 2005
FREIGHTLINER	FL70	Caterpillar 3126 Diesel	1995 - 2004
FREIGHTLINER	FL60	Caterpillar C7 Diesel	2004 - 2005
FREIGHTLINER	FL60	Cummins ISC Diesel	1998 - 1998
FREIGHTLINER	FLD	Caterpillar C10 Diesel	2000 - 2000
FREIGHTLINER	FL60	Caterpillar 3126 Diesel	1995 - 2004
FREIGHTLINER	FL80	Caterpillar C7 Diesel	2004 - 2005

**36092**



MACK	CV SERIES	Mack AI Diesel	2006 - 2007
MACK	CV SERIES	Mack AI Diesel	2003 - 2003
MACK	CV SERIES	Mack AMI Diesel	2004 - 2006
MACK	CV SERIES	Mack AMI Diesel	2003 - 2004
MACK	CX SERIES	Mack AC Diesel	2003 - 2006
MACK	CL SERIES	Mack 6-Cyl. 12.0 L Diesel	2001 - 2001
MACK	CXN SERIES	Mack AC Diesel	2006 - 2007
MACK	CH SERIES	Cummins Signature 600 Diesel	2001 - 2003
MACK	CX SERIES	Mack 6-Cyl. 12.0 L Diesel	2001 - 2002
MACK	CV SERIES	Mack 6-Cyl. 12.0 L Diesel	2001 - 2002
MACK	CT SERIES	Mack AMI Diesel	2006 - 2006
MACK	CS SERIES	Mack AC Diesel	2003 - 2003
MACK	CL SERIES	Cummins Signature 600 Diesel	2001 - 2003
KENWORTH	W900	Cummins Signature 600 Diesel	2000 - 2002
KENWORTH	W900	Cummins ISX Diesel	1999 - 2002
MACK	CH SERIES	Mack 6-Cyl. 12.0 L Diesel	2001 - 2002
STERLING	L-LINE	Cummins Signature 600 Diesel	2001 - 2001
KENWORTH	W900	Cummins ISX Diesel	2003 - 2003
MACK	CT SERIES	Mack AI Diesel	2006 - 2007
PETERBILT	379	Cummins ISX Diesel	1998 - 2002

KENWORTH	T800	Cummins ISX Diesel	1999 - 2003
PETERBILT	379	Cummins Signature 600 Diesel	2000 - 2002
VOLVO	VN SERIES	Cummins Signature 600 Diesel	2003 - 2003
VOLVO	VN SERIES	Cummins ISX Diesel	2003 - 2003
VOLVO	VN SERIES	Cummins ISX Diesel	2000 - 2002
VOLVO	VN SERIES	Cummins ISM Diesel	2002 - 2003
VOLVO	VHD	Cummins ISM Diesel	2002 - 2003
STERLING	L-LINE	Cummins ISX Diesel	2001 - 2001
PETERBILT	387	Cummins ISX Diesel	2001 - 2002
MACK	CH SERIES	Mack AC Diesel	2003 - 2006
PETERBILT	378	Cummins Signature 600 Diesel	2000 - 2002
PETERBILT	378	Cummins ISX Diesel	2000 - 2002
MACK	RD SERIES	Mack E7 Diesel	2003 - 2003
MACK	RD SERIES	Mack 6-Cyl. 12.0 L Diesel	2001 - 2002
MACK	MR SERIES	Mack 6-Cyl. 12.0 L Diesel	2001 - 2002
MACK	LE SERIES	Mack AI Diesel	2003 - 2005
MACK	DM SERIES	Mack 6-Cyl. 12.0 L Diesel	2001 - 2001
MACK	CHN SERIES	Mack AC Diesel	2006 - 2007
STERLING	L-LINE	CUMMINS SIGNATURE 600	2001 - 2001
INTERNATIONAL/NAVISTAR	9100i	Detroit Diesel Series 60 Diesel	2000 - 2000
INTERNATIONAL/NAVISTAR	9400	Detroit Diesel 6-Cyl. 12.7 L Diesel	1995 - 1996
INTERNATIONAL/NAVISTAR	9400	Detroit Diesel 6-Cyl. 11.1 L Diesel	1995 - 1996
INTERNATIONAL/NAVISTAR	9200i	Detroit Diesel Series 60 Diesel	2000 - 2000
INTERNATIONAL/NAVISTAR	9200i	Detroit Diesel 6-Cyl. 12.7 L Diesel	2001 - 2001
INTERNATIONAL/NAVISTAR	9200i	Cummins Signature 600 Diesel	2000 - 2002
INTERNATIONAL/NAVISTAR	9200	Detroit Diesel Series 60 Diesel	1998 - 1999
INTERNATIONAL/NAVISTAR	9200	Detroit Diesel 6-Cyl. 12.7 L Diesel	1995 - 1997
INTERNATIONAL/NAVISTAR	9400	Detroit Diesel Series 60 Diesel	1997 - 1999
INTERNATIONAL/NAVISTAR	CONVENTIONAL IC	International/Navistar T444 Diesel	2003 - 2003
INTERNATIONAL/NAVISTAR	9100i	Detroit Diesel 6-Cyl. 12.7 L Diesel	2001 - 2003
PETERBILT	387	Cummins Signature 600 Diesel	2001 - 2002
INTERNATIONAL/NAVISTAR	9100i	Cummins ISX Diesel	2001 - 2003
FREIGHTLINER	FLD	Cummins ISX Diesel	1999 - 2003
FREIGHTLINER	COLUMBIA	Cummins ISX Diesel	2001 - 2001
FREIGHTLINER	CENTURY CLASS	Cummins ISX Diesel	2001 - 2001
FREIGHTLINER	CENTURY CLASS	Cummins ISX Diesel	2000 - 2000
FREIGHTLINER	ARGOSY	Cummins ISX Diesel	1999 - 2003
KENWORTH	T600	Cummins Signature 600 Diesel	2003 - 2003
INTERNATIONAL/NAVISTAR	9200	Detroit Diesel 6-Cyl. 11.1 L Diesel	1995 - 1997
INTERNATIONAL/NAVISTAR	9900ix	Cummins ISX Diesel	2000 - 2002
INTERNATIONAL/NAVISTAR	9100	Detroit Diesel Series 60 Diesel	1998 - 1999

INTERNATIONAL/NAVISTAR	9400i	Cummins ISX Diesel	2000 - 2002
KENWORTH	T600	Cummins ISX Diesel	2002 - 2003
KENWORTH	T2000	Cummins ISX Diesel	1999 - 2003
INTERNATIONAL/NAVISTAR	9900ix	Detroit Diesel Series 60 Diesel	2000 - 2000
INTERNATIONAL/NAVISTAR	9900ix	Cummins ISX Diesel	2003 - 2003
INTERNATIONAL/NAVISTAR	9900i	Detroit Diesel Series 60 Diesel	2000 - 2000
INTERNATIONAL/NAVISTAR	9900i	Detroit Diesel 6-Cyl. 12.7 L Diesel	2001 - 2001
INTERNATIONAL/NAVISTAR	9900i	Cummins ISX Diesel	2003 - 2003
INTERNATIONAL/NAVISTAR	9600	Detroit Diesel 6-Cyl. 11.1 L Diesel	1996 - 1996
INTERNATIONAL/NAVISTAR	9400i	Detroit Diesel 6-Cyl. 12.7 L Diesel	2001 - 2001
INTERNATIONAL/NAVISTAR	9900ix	Detroit Diesel 6-Cyl. 12.7 L Diesel	2001 - 2001
INTERNATIONAL/NAVISTAR	9400i	Detroit Diesel Series 60 Diesel	2000 - 2000
INTERNATIONAL/NAVISTAR	9900i	Cummins ISX Diesel	2000 - 2002
INTERNATIONAL/NAVISTAR	9600	Detroit Diesel 6-Cyl. 12.7 L Diesel	1995 - 1995
INTERNATIONAL/NAVISTAR	9700	Detroit Diesel 6-Cyl. 11.1 L Diesel	1996 - 1996
INTERNATIONAL/NAVISTAR	9900	Detroit Diesel Series 60 Diesel	1999 - 1999
INTERNATIONAL/NAVISTAR	9700	Detroit Diesel 6-Cyl. 12.7 L Diesel	1996 - 1996
INTERNATIONAL/NAVISTAR	9800	Detroit Diesel Series 60 Diesel	1997 - 1997

**36093**



KENWORTH	T2000	Caterpillar C15 Diesel	2004 - 2007
KENWORTH	T300	Cummins ISC Diesel	2001 - 2004
KENWORTH	T600	Caterpillar C15 Diesel	2000 - 2007
KENWORTH	T660	Caterpillar C15 Diesel	2007 - 2007
KENWORTH	T800	Caterpillar C13 Diesel	2004 - 2007
KENWORTH	W900	Caterpillar C13 Diesel	2004 - 2007
KENWORTH	T800	Cummins ISL Diesel	2001 - 2008
INTERNATIONAL/NAVISTAR	WORKSTAR 7700	Caterpillar C13 Diesel	2008 - 2008
KENWORTH	W900	Caterpillar C11 Diesel	2005 - 2007
KENWORTH	W900	Cummins ISC Diesel	2003 - 2004
KENWORTH	W900	Caterpillar C15 Diesel	2004 - 2008
INTERNATIONAL/NAVISTAR	7600	Caterpillar C13 Diesel	2004 - 2008
KENWORTH	T800	CUMMINS ISL	2006 - 2006
INTERNATIONAL/NAVISTAR	TRANSTAR 8600	Caterpillar C13 Diesel	2008 - 2008
INTERNATIONAL/NAVISTAR	TRANSTAR 8500	Caterpillar C13 Diesel	2008 - 2008



INTERNATIONAL/NAVISTAR	PAYSTAR 5600i	Caterpillar C15 Diesel	2008 - 2008
INTERNATIONAL/NAVISTAR	9900ix	Caterpillar C15 Diesel	2004 - 2007
INTERNATIONAL/NAVISTAR	9900i	Caterpillar C15 Diesel	2004 - 2007
INTERNATIONAL/NAVISTAR	9900i	Caterpillar C13 Diesel	2004 - 2007
INTERNATIONAL/NAVISTAR	9400i	Caterpillar C15 Diesel	2004 - 2007
INTERNATIONAL/NAVISTAR	9400i	Caterpillar C13 Diesel	2004 - 2007
INTERNATIONAL/NAVISTAR	9200i	Caterpillar C13 Diesel	2004 - 2007
INTERNATIONAL/NAVISTAR	7700	Caterpillar C13 Diesel	2005 - 2007
INTERNATIONAL/NAVISTAR	5900i	Caterpillar C13 Diesel	2005 - 2007
PETERBILT	330	Cummins ISC Diesel	1999 - 2005
STERLING	A-LINE	Caterpillar C13 Diesel	2004 - 2007
INTERNATIONAL/NAVISTAR	8600	Caterpillar C13 Diesel	2004 - 2007
PETERBILT	386	Caterpillar C15 Diesel	2006 - 2007
STERLING	L-LINE	Cummins ISB Diesel	2000 - 2000
STERLING	L-LINE	Caterpillar C15 Diesel	2004 - 2007
STERLING	L-LINE	Caterpillar C13 Diesel	2004 - 2007
STERLING	L-LINE	Caterpillar C11 Diesel	2004 - 2007
STERLING	A-LINE	Caterpillar C15 Diesel	2004 - 2007
KENWORTH	T800	Caterpillar C11 Diesel	2003 - 2008
STERLING	A-LINE	Caterpillar C11 Diesel	2004 - 2007
INTERNATIONAL/NAVISTAR	5600i	Caterpillar C13 Diesel	2005 - 2007
STERLING	ACTERRA	Caterpillar C13 Diesel	2004 - 2006
PETERBILT	388	Caterpillar C15 Diesel	2007 - 2007
PETERBILT	387	Caterpillar C15 Diesel	2004 - 2007
STERLING	ACTERRA	Cummins ISC Diesel	2005 - 2008
PETERBILT	387	Caterpillar C11 Diesel	2006 - 2006
PETERBILT	335	Cummins ISC Diesel	2005 - 2006
PETERBILT	386	Caterpillar C13 Diesel	2007 - 2007
PETERBILT	385	Caterpillar C13 Diesel	2005 - 2007
PETERBILT	385	Caterpillar C11 Diesel	2005 - 2007
PETERBILT	379	Caterpillar C15 Diesel	2004 - 2007
PETERBILT	379	Caterpillar C13 Diesel	2004 - 2006
PETERBILT	379	Caterpillar C11 Diesel	2005 - 2006
PETERBILT	378	Caterpillar C15 Diesel	2004 - 2007
PETERBILT	378	Caterpillar C13 Diesel	2005 - 2006
PETERBILT	378	Caterpillar C11 Diesel	2004 - 2007
PETERBILT	357	Caterpillar C15 Diesel	2004 - 2007
PETERBILT	357	Caterpillar C13 Diesel	2005 - 2007
PETERBILT	357	Caterpillar C11 Diesel	2005 - 2007
PETERBILT	387	Caterpillar C13 Diesel	2004 - 2006
FORD	F650 SUPER DUTY	Cummins ISB Diesel	2002 - 2004

FREIGHTLINER	COLUMBIA	Caterpillar C13 Diesel	2004 - 2008
FREIGHTLINER	COLUMBIA	Caterpillar C11 Diesel	2004 - 2007
FREIGHTLINER	CLASSIC XL	Caterpillar C15 Diesel	2004 - 2007
FREIGHTLINER	CLASSIC XL	Caterpillar C13 Diesel	2004 - 2006
FREIGHTLINER	CLASSIC XL	Caterpillar C11 Diesel	2004 - 2006
FREIGHTLINER	CLASSIC	Caterpillar C15 Diesel	2004 - 2007
FREIGHTLINER	CLASSIC	Caterpillar C11 Diesel	2004 - 2006
FREIGHTLINER	CENTURY CLASS	Caterpillar C13 Diesel	2004 - 2007
FREIGHTLINER	CENTURY CLASS	Caterpillar C11 Diesel	2004 - 2006
FREIGHTLINER	BUSINESS CLASS M2	Cummins ISC Diesel	2004 - 2004
FREIGHTLINER	BUSINESS CLASS M2	Caterpillar C13 Diesel	2004 - 2007
FORD	F750 SUPER DUTY	Cummins ISB Diesel	2002 - 2004
FREIGHTLINER	COLUMBIA	Caterpillar C15 Diesel	2004 - 2008
FORD	F750 SUPER DUTY	Cummins ISB Diesel	2001 - 2001
FREIGHTLINER	CLASSIC	Caterpillar C13 Diesel	2004 - 2007
FORD	F650 SUPER DUTY	Cummins ISB Diesel	2000 - 2000
FORD	F650 SUPER DUTY	Cummins ISB Diesel	2001 - 2001
THOMAS BUILT	SAF-T-LINER MVP ER	Cummins ISC Diesel	2000 - 2000
THOMAS BUILT	SAF-T-LINER MVP ER	Cummins ISB Diesel	1999 - 2000
THOMAS BUILT	SAF-T-LINER MVP EF	Cummins ISB Diesel	2000 - 2002
THOMAS BUILT	SAF-T-LINER C2	Caterpillar C7 Diesel	2008 - 2008
THOMAS BUILT	CONVENTIONAL	Cummins ISB Diesel	2000 - 2003
BLUEBIRD	TC2000	Cummins ISB Diesel	1998 - 2000
BLUEBIRD	CONVENTIONAL	Cummins ISB Diesel	2001 - 2001
BLUEBIRD	ALL AMERICAN RE	Cummins ISC Diesel	2001 - 2003
INTERNATIONAL/NAVISTAR	5500i	Caterpillar C13 Diesel	2005 - 2007
KENWORTH	T800	Caterpillar C15 Diesel	2004 - 2007
FORD	F750 SUPER DUTY	Cummins ISB Diesel	2000 - 2000
FREIGHTLINER	FL80	Cummins B Series 5.9 L Diesel	1997 - 1997
FREIGHTLINER	FLD	Caterpillar C15 Diesel	2004 - 2008
FREIGHTLINER	FLD	Caterpillar C13 Diesel	2004 - 2007
FREIGHTLINER	FLD	Caterpillar C11 Diesel	2004 - 2007
FREIGHTLINER	FL80	Cummins ISC Diesel	2002 - 2005
FREIGHTLINER	FL80	Cummins ISB Diesel	1998 - 1999
FREIGHTLINER	CENTURY CLASS	Caterpillar C15 Diesel	2004 - 2007
FREIGHTLINER	FL80	Cummins ISB Diesel	2000 - 2001
FREIGHTLINER	CONDOR	Caterpillar C11 Diesel	2004 - 2005
FREIGHTLINER	FL70	Cummins ISC Diesel	1999 - 2005
FREIGHTLINER	FL70	Cummins ISB Diesel	1998 - 1999
FREIGHTLINER	FL70	Cummins ISB Diesel	2002 - 2003
FREIGHTLINER	FL70	Cummins ISB Diesel	2000 - 2001



FREIGHTLINER	FL70	Cummins B Series 5.9 L Diesel	1997 - 1997
FREIGHTLINER	FL60	Cummins ISC Diesel	1999 - 2004
FREIGHTLINER	FL50	Cummins ISB Diesel	2002 - 2003
FREIGHTLINER	CORONADO	Caterpillar C15 Diesel	2004 - 2007
FREIGHTLINER	FL80	Cummins ISB Diesel	2002 - 2003
FREIGHTLINER	FL60	Cummins ISB Diesel	1998 - 1999
FREIGHTLINER	CONDOR	Caterpillar C13 Diesel	2004 - 2005
FREIGHTLINER	FL50	Cummins B Series 5.9 L Diesel	1997 - 1997
FREIGHTLINER	FL50	Cummins ISB Diesel	2000 - 2001
FREIGHTLINER	FL50	Cummins ISB Diesel	1998 - 1999
BLUEBIRD	ALL AMERICAN RE	Cummins ISB Diesel	1999 - 1999
FREIGHTLINER	FL50	Cummins ISC Diesel	1999 - 2005
FREIGHTLINER	FL60	Cummins B Series 5.9 L Diesel	1997 - 1997
FREIGHTLINER	FL60	Cummins ISB Diesel	2000 - 2001
FREIGHTLINER	FL60	Cummins ISB Diesel	2002 - 2003

36095



KENWORTH	W900	Cummins Signature 600 Diesel	2000 - 2002
VOLVO	VN SERIES	Cummins ISX Diesel	2000 - 2002
KENWORTH	W900	Cummins ISX Diesel	2003 - 2003
PETERBILT	379	Cummins ISX Diesel	1998 - 2002
MACK	CH SERIES	Cummins Signature 600 Diesel	2001 - 2003
PETERBILT	378	Cummins ISX Diesel	2000 - 2002
PETERBILT	378	Cummins Signature 600 Diesel	2000 - 2002
MACK	CL SERIES	Cummins Signature 600 Diesel	2001 - 2003
PETERBILT	379	Cummins Signature 600 Diesel	2000 - 2002
PETERBILT	387	Cummins ISX Diesel	2001 - 2002
PETERBILT	387	Cummins Signature 600 Diesel	2001 - 2002
STERLING	L-LINE	Cummins ISX Diesel	2001 - 2001
STERLING	L-LINE	Cummins Signature 600 Diesel	2001 - 2001
VOLVO	VN SERIES	Cummins ISX Diesel	2003 - 2003
VOLVO	VN SERIES	Cummins Signature 600 Diesel	2003 - 2003
INTERNATIONAL/NAVISTAR	9900i	Cummins ISX Diesel	2003 - 2003
KENWORTH	W900	Cummins ISX Diesel	1999 - 2002
STERLING	L-LINE	CUMMINS SIGNATURE 600	2001 - 2001

FREIGHTLINER	COLUMBIA	Cummins ISX Diesel	2001 - 2001
KENWORTH	T800	Cummins ISX Diesel	1999 - 2003
INTERNATIONAL/NAVISTAR	9900ix	Cummins ISX Diesel	2003 - 2003
FORD	F600	Cummins B Series 5.9 L Diesel	1992 - 1994
FREIGHTLINER	CENTURY CLASS	Cummins ISX Diesel	2000 - 2001
FREIGHTLINER	FC70	Cummins ISB Diesel	2003 - 2003
FREIGHTLINER	FC80	Cummins ISB Diesel	2003 - 2003
FREIGHTLINER	FLD	Cummins ISX Diesel	1999 - 2003
INTERNATIONAL/NAVISTAR	9200i	Cummins Signature 600 Diesel	2000 - 2002
INTERNATIONAL/NAVISTAR	9400i	Cummins ISX Diesel	2000 - 2002
INTERNATIONAL/NAVISTAR	9900i	Cummins ISX Diesel	2000 - 2002
INTERNATIONAL/NAVISTAR	9900ix	Cummins ISX Diesel	2000 - 2002
KENWORTH	T600	Cummins Signature 600 Diesel	2003 - 2003
KENWORTH	T2000	Cummins ISX Diesel	1999 - 2003
INTERNATIONAL/NAVISTAR	9100i	Cummins ISX Diesel	2001 - 2003
FREIGHTLINER	ARGOSY	Cummins ISX Diesel	1999 - 2003
KENWORTH	T600	Cummins ISX Diesel	2002 - 2003

36096



STERLING	ACTERRA	Caterpillar C7 Diesel	2004 - 2007
FREIGHTLINER	FL50	Caterpillar 3126 Diesel	2003 - 2004
FREIGHTLINER	FL70	Caterpillar 3126 Diesel	1995 - 2004
KENWORTH	T300	Caterpillar C7 Diesel	2004 - 2007
PETERBILT	320	Caterpillar C7 Diesel	2004 - 2007
PETERBILT	330	Caterpillar C7 Diesel	2004 - 2007
STERLING	ACTERRA	Caterpillar 3126 Diesel	2001 - 2004
FREIGHTLINER	FL50	Caterpillar 3126 Diesel	1995 - 2002
FREIGHTLINER	FL60	Caterpillar 3126 Diesel	1995 - 2004
PETERBILT	335	Caterpillar C7 Diesel	2005 - 2007
FREIGHTLINER	BUSINESS CLASS M2	Caterpillar 3126 Diesel	2007 - 2007
CHEVROLET	KODIAK	CATERPILLAR 3126 DIESEL	2000 - 2008
CHEVROLET	KODIAK	CATERPILLAR 3116 DIESEL	1997 - 2000
CHEVROLET	C8500	Caterpillar C7 Diesel	2004 - 2007
CHEVROLET	C8500	Caterpillar 3126 Diesel	1998 - 2003
CHEVROLET	C7500	Caterpillar C7 Diesel	2004 - 2007

CHEVROLET	C7500	Caterpillar 3126 Diesel	1998 - 2003
CHEVROLET	C6500	Caterpillar C7 Diesel	2004 - 2007
CHEVROLET	C6500	Caterpillar 3126 Diesel	1998 - 2003
CHEVROLET	C5500	Caterpillar 3126 Diesel	1998 - 2002
FREIGHTLINER	FL80	Caterpillar 3126 Diesel	1995 - 2005
FREIGHTLINER	BUSINESS CLASS M2	Caterpillar C7 Diesel	2007 - 2007

**36098**



VOLVO	VN SERIES	Cummins N14 Diesel	2000 - 2003
-------	-----------	--------------------	-------------

**36157**

Acero D.E. 87mm D.B. 17mm A - 31mm V-Ranurada



FORD	F550 SUPER DUTY	Ford V-10 6.8 L	2002 - 2006
FORD	F450 SUPER DUTY	Ford V-10 6.8 L	2002 - 2006
FORD	E450 SUPER DUTY	Ford V-10 6.8 L	2006 - 2007

**38001**

Acero D.E. 90mm D.B. 17mm A - 30mm Lisa



CHEVROLET	C5500	GM V-8 8.1 L	2007 - 2007
FORD	F450 SUPER DUTY	Ford V-10 6.8 L	2002 - 2006
FORD	E550 SUPER DUTY	Ford V-10 6.8 L	2002 - 2003
THOMAS BUILT	MINOTOUR	GM V-8 4.8 L	2004 - 2004
FORD	E450 SUPER DUTY	Ford V-10 6.8 L	2006 - 2007
FORD	E450 SUPER DUTY	Ford V-10 6.8 L	2002 - 2005
CHEVROLET	W3500	GM V-8 6.0 L	2006 - 2006

CHEVROLET	C5500	GM V-8 8.1 L	2003 - 2006
FORD	F550 SUPER DUTY	Ford V-10 6.8 L	2002 - 2006
CHEVROLET	C5500	GM V-8 8.1 L	2003 - 2006
CHEVROLET	C5500	GM V-8 8.1 L	2008 - 2008
CHEVROLET	C4500	GM V-8 8.1 L	2003 - 2006
CHEVROLET	C4500	GM V-8 8.1 L	2007 - 2007
CHEVROLET	C4500	GM V-8 8.1 L	2003 - 2006
THOMAS BUILT	MINOTOUR	GM V-8 6.0 L	2005 - 2006
BLUEBIRD	MINI BIRD	GM V-8 5.7 L	1998 - 1998
CHEVROLET	C4500	GM V-8 8.1 L	2008 - 2008

**38006**

Acero D.E. 76mm D.B. 17mm A - 30.5mm Lisa



CHEVROLET	C7500	GM V-8 8.1 L	2001 - 2008
FORD	E450 SUPER DUTY	Ford V-10 6.8 L	2007 - 2007
CHEVROLET	C8500	GM V-8 8.1 L	2001 - 2008
CHEVROLET	C5500	GM V-8 8.1 L	2001 - 2002
CHEVROLET	C5500	GM V-8 8.1 L	2003 - 2008
CHEVROLET	C4500	GM V-8 8.1 L	2003 - 2008
CHEVROLET	C6500	GM V-8 8.1 L	2001 - 2008

**38008**

Termoplástico D.E. 70mm D.B. 17mm A - 34.5mm V-Ranurada

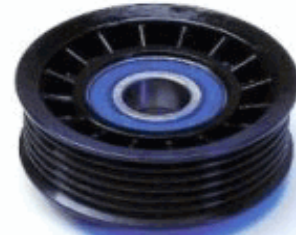

CHEVROLET	C5500	GM V-8 6.6 L Diesel	2003 - 2008
CHEVROLET	C5500	GM V-8 8.1 L	2003 - 2007
CHEVROLET	C4500	GM V-8 8.1 L	2003 - 2007
CHEVROLET	C4500	GM V-8 6.6 L Diesel	2003 - 2008
THOMAS BUILT	MINOTOUR	GM V-8 5.7 L	2001 - 2001
BLUEBIRD	MINI BIRD	GM V-8 5.7 L	1998 - 1998
BLUEBIRD	MINI BIRD	GM V-8 5.7 L	1998 - 1998

**38009**

Termoplástico D.E. 76mm D.B. 17mm A - 25mm V-Ranurada



THOMAS BUILT	MINOTOUR	GM V-8 6.0 L	2005 - 2006
CHEVROLET	W3500	GM V-8 6.0 L	2006 - 2007
CHEVROLET	W4500	GM V-8 6.0 L	2006 - 2007
THOMAS BUILT	MINOTOUR	GM V-8 4.8 L	2004 - 2004

**38023**

Termoplástico D.E. 76mm D.B. 17mm A - 34mm Lisa

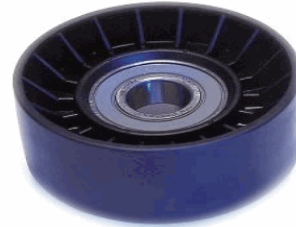

FORD	F550 SUPER DUTY	Ford V-10 6.8 L	1999 - 2001
FORD	F550 SUPER DUTY	Ford V-10 6.8 L	1999 - 2001
FORD	F450 SUPER DUTY	Ford V-10 6.8 L	1999 - 2001
FORD	F450 SUPER DUTY	Ford V-10 6.8 L	1999 - 2001
FORD	E550 SUPER DUTY	Ford V-10 6.8 L	2002 - 2003
FORD	E450 SUPER DUTY	Ford V-8 5.4 L	2000 - 2001
FORD	E450 SUPER DUTY	Ford V-10 6.8 L	1999 - 2005

**38015**

Termoplástico D.E. 76mm D.B. 17mm A - 25mm Lisa



FORD	F SUPER DUTY	Ford V-8 7.3 L Diesel	1993 - 1993
FORD	F SUPER DUTY	Ford V-8 7.3 L Diesel	1992 - 1992
FORD	F SUPER DUTY	Ford V-8 7.3 L Diesel	1994 - 1994

**38028**

Acero D.E. 76mm D.B. 17mm A - 37mm Lisa



FORD	E550 SUPER DUTY	Ford V-8 7.3 L Diesel	2002 - 2003
FORD	F450 SUPER DUTY	Ford V-8 7.3 L Diesel	1999 - 2003
FORD	F550 SUPER DUTY	Ford V-8 7.3 L Diesel	1999 - 2004
FORD	F650 SUPER DUTY	Ford V-8 7.3 L Diesel	2000 - 2004
FORD	F750 SUPER DUTY	Ford V-8 7.3 L Diesel	2000 - 2004
FORD	E450 SUPER DUTY	Ford V-8 7.3 L Diesel	1998 - 2003

**38022**

Acero D.E. 90mm D.B. 17mm A - 37.5mm Lisa

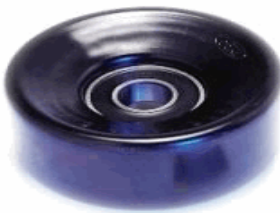

FORD	E450 SUPER DUTY	Ford V-10 6.8 L	1999 - 2001
FORD	F450 SUPER DUTY	Ford V-10 6.8 L	1999 - 2001
FORD	F550 SUPER DUTY	Ford V-10 6.8 L	1999 - 2001
FORD	E450 SUPER DUTY	Ford V-8 5.4 L	2000 - 2001
FORD	F SUPER DUTY	Ford V-8 7.3 L Diesel	1995 - 1998

**38033**

Acero D.E. 90mm D.B. 17mm A - 33mm Lisa



CHEVROLET	C8500	GM V-8 8.1 L	2001 - 2008
CHEVROLET	C7500	GM V-8 8.1 L	2001 - 2008
CHEVROLET	C6500	GM V-8 8.1 L	2001 - 2008
CHEVROLET	C5500	GM V-8 8.1 L	2001 - 2002

**38053**

Acero D.E. 76mm D.B. 17mm A - 38mm V-Ranurada



FORD	E550 SUPER DUTY	Ford V-8 7.3 L Diesel	2002 - 2003
FORD	F450 SUPER DUTY	Ford V-8 7.3 L Diesel	1999 - 2003
FORD	F550 SUPER DUTY	Ford V-8 7.3 L Diesel	1999 - 2004
FORD	F650 SUPER DUTY	Ford V-8 7.3 L Diesel	2000 - 2004
FORD	F750 SUPER DUTY	Ford V-8 7.3 L Diesel	2000 - 2004
FORD	E450 SUPER DUTY	Ford V-8 7.3 L Diesel	1998 - 2003

**38075**



FREIGHTLINER	FLD	Detroit Diesel 6-Cyl. 14.0 L Diesel	2001 - 2008
PETERBILT	379	Detroit Diesel 6-Cyl. 12.7 L Diesel	2000 - 2001
PETERBILT	379	Detroit Diesel 6-Cyl. 11.1 L Diesel	2000 - 2001
KENWORTH	W900	Detroit Diesel 6-Cyl. 12.7 L Diesel	2000 - 2001
KENWORTH	W900	Detroit Diesel 6-Cyl. 11.1 L Diesel	2000 - 2001
KENWORTH	T800	DETROIT DIESEL SERIE 60	2001 - 2001
KENWORTH	T800	Detroit Diesel 6-Cyl. 12.7 L Diesel	2000 - 2001
KENWORTH	T800	Detroit Diesel 6-Cyl. 11.1 L Diesel	2000 - 2001
KENWORTH	T2000	Detroit Diesel 6-Cyl. 12.7 L Diesel	2000 - 2000
STERLING	A-LINE	Detroit Diesel 6-Cyl. 11.1 L Diesel	2000 - 2000
FREIGHTLINER	FLD120	DETROIT DIESEL SERIE 60	1999 - 2001
STERLING	A-LINE	DETROIT DIESEL SERIE 60	2001 - 2001
FREIGHTLINER	FLD	Detroit Diesel 6-Cyl. 12.7 L Diesel	2000 - 2008
FREIGHTLINER	FLD	Detroit Diesel 6-Cyl. 11.1 L Diesel	2000 - 2002
FREIGHTLINER	CORONADO	DETROIT DIESEL SERIE 60	2004 - 2004
KENWORTH	T2000	Detroit Diesel 6-Cyl. 11.1 L Diesel	2000 - 2000
STERLING	L-LINE	Detroit Diesel 6-Cyl. 12.7 L Diesel	2000 - 2001
FREIGHTLINER	CORONADO	DETROIT DIESEL SERIE 60	2006 - 2006
STERLING	L-LINE	Mercedes-Benz MBE 4000 Diesel	2003 - 2007

STERLING	L-LINE	DETROIT DIESEL SERIE 60	2004 - 2006
STERLING	L-LINE	DETROIT DIESEL SERIE 60	2003 - 2003
STERLING	L-LINE	DETROIT DIESEL SERIE 60	2001 - 2001
STERLING	A-LINE	Detroit Diesel 6-Cyl. 12.7 L Diesel	2001 - 2006
STERLING	L-LINE	Detroit Diesel 6-Cyl. 12.7 L Diesel	2003 - 2008
STERLING	A-LINE	Detroit Diesel 6-Cyl. 11.1 L Diesel	2001 - 2001
STERLING	L-LINE	Detroit Diesel 6-Cyl. 11.1 L Diesel	2000 - 2001
STERLING	A-LINE	Mercedes-Benz MBE 4000 Diesel	2004 - 2006
STERLING	A-LINE	DETROIT DIESEL SERIE 60	2004 - 2006
FREIGHTLINER	CLASSIC	Detroit Diesel 6-Cyl. 14.0 L Diesel	2003 - 2008
STERLING	A-LINE	Detroit Diesel 6-Cyl. 14.0 L Diesel	2004 - 2006
STERLING	A-LINE	Detroit Diesel 6-Cyl. 12.7 L Diesel	2000 - 2000
STERLING	L-LINE	Detroit Diesel 6-Cyl. 14.0 L Diesel	2003 - 2008
FREIGHTLINER	CLASSIC XL	Detroit Diesel 6-Cyl. 11.1 L Diesel	2001 - 2002
FREIGHTLINER	CENTURY CLASS	Mercedes-Benz MBE 4000 Diesel	2005 - 2005
FREIGHTLINER	CENTURY CLASS	Mercedes-Benz MBE 4000 Diesel	2001 - 2001
FREIGHTLINER	CENTURY CLASS	DETROIT DIESEL SERIE 60	2005 - 2005
FREIGHTLINER	CENTURY CLASS	DETROIT DIESEL SERIE 60	2002 - 2003
FREIGHTLINER	CENTURY CLASS	Detroit Diesel 6-Cyl. 14.0 L Diesel	2003 - 2007
FREIGHTLINER	CLASSIC	Detroit Diesel 6-Cyl. 11.1 L Diesel	2001 - 2002
FREIGHTLINER	CENTURY CLASS	Detroit Diesel 6-Cyl. 11.1 L Diesel	1999 - 2003
FREIGHTLINER	CENTURY CLASS	Detroit Diesel 6-Cyl. 12.7 L Diesel	1999 - 2007
FREIGHTLINER	BUSINESS CLASS M2	Mercedes-Benz MBE 4000 Diesel	2004 - 2007
FREIGHTLINER	ARGOSY	Detroit Diesel 6-Cyl. 14.0 L Diesel	2003 - 2006
FREIGHTLINER	ARGOSY	Detroit Diesel 6-Cyl. 12.7 L Diesel	1999 - 1999
FREIGHTLINER	ARGOSY	Detroit Diesel 6-Cyl. 12.7 L Diesel	2000 - 2006
FREIGHTLINER	ARGOSY	Detroit Diesel 6-Cyl. 11.1 L Diesel	1999 - 1999
FREIGHTLINER	ARGOSY	Detroit Diesel 6-Cyl. 11.1 L Diesel	2000 - 2003
FREIGHTLINER	CORONADO	DETROIT DIESEL SERIE 60	2005 - 2005
FREIGHTLINER	COLUMBIA	DETROIT DIESEL SERIE 60	2006 - 2006
FREIGHTLINER	CORONADO	Detroit Diesel 6-Cyl. 14.0 L Diesel	2003 - 2008
FREIGHTLINER	CASCADIA	Detroit Diesel 6-Cyl. 14.0 L Diesel	2008 - 2008
FREIGHTLINER	CLASSIC	Detroit Diesel 6-Cyl. 12.7 L Diesel	2001 - 2007
FREIGHTLINER	CORONADO	Detroit Diesel 6-Cyl. 12.7 L Diesel	2002 - 2008
FREIGHTLINER	COLUMBIA	Mercedes-Benz MBE 4000 Diesel	2005 - 2007
FREIGHTLINER	COLUMBIA	DETROIT DIESEL SERIE 60	2005 - 2005
FREIGHTLINER	COLUMBIA	DETROIT DIESEL SERIE 60	2001 - 2001
FREIGHTLINER	COLUMBIA	Detroit Diesel 6-Cyl. 14.0 L Diesel	2002 - 2008
FREIGHTLINER	COLUMBIA	Detroit Diesel 6-Cyl. 12.7 L Diesel	2000 - 2008
FREIGHTLINER	COLUMBIA	Detroit Diesel 6-Cyl. 11.1 L Diesel	2000 - 2001
FREIGHTLINER	CLASSIC XL	Detroit Diesel 6-Cyl. 14.0 L Diesel	2001 - 2008

FREIGHTLINER	CLASSIC XL	Detroit Diesel 6-Cyl. 12.7 L Diesel	2001 - 2007
FREIGHTLINER	CLASSIC	DETROIT DIESEL SERIE 60	2005 - 2005
FREIGHTLINER	COLUMBIA	MERCEDES-BENZ MBE 4000 DIESEL	2005 - 2005

38076

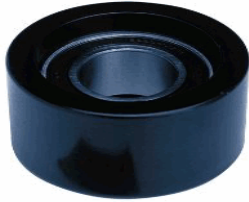

FREIGHTLINER	COLUMBIA	DETROIT DIESEL SERIE 60	2006 - 2005
FREIGHTLINER	CORONADO	Detroit Diesel 6-Cyl. 12.7 L Diesel	2002 - 2008
FREIGHTLINER	CENTURY CLASS	DETROIT DIESEL SERIE 60	2005 - 2005

38092



VOLVO	VNL 64T 420 STANDAR	DETROIT DIESEL SERIE 60	1999 - 2000
STERLING	A-LINE	DETROIT DIESEL SERIE 60	2004 - 2005
FREIGHTLINER	FLD	Detroit Diesel 6-Cyl. 12.7 L Diesel	2005 - 2008
FREIGHTLINER	FLD	Detroit Diesel 6-Cyl. 14.0 L Diesel	2005 - 2008
STERLING	A-LINE	Detroit Diesel 6-Cyl. 12.7 L Diesel	2004 - 2006
VOLVO	VNL 64T 610	DETROIT DIESEL SERIE 60	1999 - 2000
STERLING	A-LINE	Detroit Diesel 6-Cyl. 14.0 L Diesel	2004 - 2006
FREIGHTLINER	CORONADO	DETROIT DIESEL SERIE 60	2006 - 2006
STERLING	A-LINE	DETROIT DIESEL SERIE 60	2006 - 2006
STERLING	L-LINE	Detroit Diesel 6-Cyl. 12.7 L Diesel	2004 - 2008
STERLING	L-LINE	Detroit Diesel 6-Cyl. 14.0 L Diesel	2004 - 2008
STERLING	L-LINE	DETROIT DIESEL SERIE 60	2004 - 2005
STERLING	L-LINE	DETROIT DIESEL SERIE 60	2006 - 2006
VOLVO	VNL 64T 420 6X4 TIPICO	DETROIT DIESEL SERIE 60	1999 - 2000
FREIGHTLINER	CORONADO	DETROIT DIESEL SERIE 60	2005 - 2005
FREIGHTLINER	CLASSIC	DETROIT DIESEL SERIE 60	2005 - 2005
VOLVO	VNL 64T 420	DETROIT DIESEL SERIE 60	2001 - 2001
FREIGHTLINER	ARGOSY	Detroit Diesel 6-Cyl. 11.1 L Diesel	2001 - 2000
FREIGHTLINER	CLASSIC XL	Detroit Diesel 6-Cyl. 14.0 L Diesel	2005 - 2008
FREIGHTLINER	CORONADO	Detroit Diesel 6-Cyl. 14.0 L Diesel	2003 - 2008
FREIGHTLINER	ARGOSY	Detroit Diesel 6-Cyl. 12.7 L Diesel	2002 - 2001
FREIGHTLINER	ARGOSY	Detroit Diesel 6-Cyl. 14.0 L Diesel	2003 - 2006
FREIGHTLINER	CASCADIA	Detroit Diesel 6-Cyl. 14.0 L Diesel	2008 - 2008
FREIGHTLINER	CENTURY CLASS	Detroit Diesel 6-Cyl. 12.7 L Diesel	2004 - 2007
FREIGHTLINER	CENTURY CLASS	Detroit Diesel 6-Cyl. 14.0 L Diesel	2004 - 2007
FREIGHTLINER	CLASSIC	Detroit Diesel 6-Cyl. 12.7 L Diesel	2005 - 2007
FREIGHTLINER	CLASSIC	Detroit Diesel 6-Cyl. 14.0 L Diesel	2005 - 2008
FREIGHTLINER	CLASSIC XL	Detroit Diesel 6-Cyl. 12.7 L Diesel	2005 - 2007
FREIGHTLINER	COLUMBIA	Detroit Diesel 6-Cyl. 12.7 L Diesel	2004 - 2008
FREIGHTLINER	COLUMBIA	Detroit Diesel 6-Cyl. 14.0 L Diesel	2004 - 2008

FREIGHTLINER	FL112	Caterpillar C10 Diesel	1999 - 2000
FREIGHTLINER	FLD	Caterpillar C12 Diesel	1998 - 2000
FREIGHTLINER	CENTURY CLASS	Caterpillar C10 Diesel	1999 - 2000
FREIGHTLINER	FL112	Caterpillar C12 Diesel	1999 - 2000
FREIGHTLINER	CENTURY CLASS	Caterpillar C12 Diesel	1999 - 2000
FREIGHTLINER	FLD	Caterpillar C10 Diesel	1998 - 2000

38103

Termoplástico V-Ranurada 6 costillas (70 mm x 17 mm x 25 mm)



BLUEBIRD	MINI BIRD	GM V-8 5.7 L	1998 - 1998
THOMAS BUILT	MINOTOUR	GM V-8 5.7 L	2001 - 2001

38133

Termoplástico Lisa/Posterior (76 mm x 17 mm x 34 mm)



FORD	F550 SUPER DUTY	Ford V-10 6.8 L	1999 - 2001
FORD	E450 SUPER DUTY	Ford V-10 6.8 L	1999 - 2005
FORD	E450 SUPER DUTY	Ford V-8 5.4 L	2000 - 2001
FORD	E550 SUPER DUTY	Ford V-10 6.8 L	2002 - 2003
FORD	F450 SUPER DUTY	Ford V-10 6.8 L	1999 - 2001

**38158**

Termoplástico V-Ranurada 6 costillas (76 mm x 17 mm x 25 mm)



CHEVROLET	W4500	GM V-8 6.0 L	2006 - 2007
CHEVROLET	W3500	GM V-8 6.0 L	2006 - 2007
THOMAS BUILT	MINOTOUR	GM V-8 4.8 L	2005 - 2005
THOMAS BUILT	MINOTOUR	GM V-8 6.0 L	2005 - 2006
THOMAS BUILT	MINOTOUR	GM V-8 4.8 L	2004 - 2004

**38191**

Acero Lisa/Posterior (76 mm x 17 mm x 37 mm); Acero V-Ranurada 8 costillas (76 mm x 17 mm x 38 mm)



FORD	F750 SUPER DUTY	Ford V-8 7.3 L Diesel	2000 - 2004
FORD	F450 SUPER DUTY	Ford V-8 7.3 L Diesel	1999 - 2003
FORD	F550 SUPER DUTY	Ford V-8 7.3 L Diesel	1999 - 2004
FORD	F650 SUPER DUTY	Ford V-8 7.3 L Diesel	2000 - 2004

**38159**

Acero Lisa/Posterior (60 mm x 12 mm x 21 mm)



THOMAS BUILT	MINOTOUR	GM V-8 4.8 L	2004 - 2005
THOMAS BUILT	MINOTOUR	GM V-8 6.0 L	2005 - 2006
CHEVROLET	W3500	GM V-8 6.0 L	2006 - 2007
CHEVROLET	W4500	GM V-8 6.0 L	2006 - 2007

**38256**



CHEVROLET	KODIAK	GM V-8, 8.1 L	2001 - 2008
CHEVROLET	C8500	GM V-8 8.1 L	2001 - 2008
CHEVROLET	C7500	GM V-8 8.1 L	2001 - 2008
CHEVROLET	C5500	GM V-8 8.1 L	2001 - 2002
CHEVROLET	C6500	GM V-8 8.1 L	2001 - 2008

**38172**

Acero V-Ranurada 6 costillas (70 mm x 17 mm x 24 mm)



CHEVROLET	C4500	GM V-8 6.6 L Diesel	2003 - 2008
CHEVROLET	C5500	GM V-8 6.6 L Diesel	2003 - 2008

**38257**



FORD	E450 SUPER DUTY	Ford V-8 6.0 L Diesel	2003 - 2006
FORD	F450 SUPER DUTY	Ford V-8 6.0 L Diesel	2003 - 2007
FORD	F550 SUPER DUTY	Ford V-8 6.0 L Diesel	2003 - 2007

**38258**

Acero Lisa/Posterior (76 mm x 17 mm x 30.5 mm)



CHEVROLET	C5500	GM V-8 8.1 L	2008 - 2008
CHEVROLET	C4500	GM V-8 8.1 L	2003 - 2007
CHEVROLET	C4500	GM V-8 8.1 L	2008 - 2008
CHEVROLET	C5500	GM V-8 8.1 L	2003 - 2007

**38324**

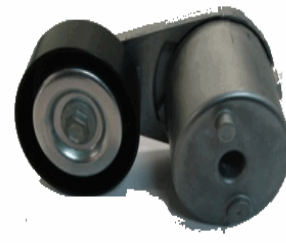

CHEVROLET	C8500	GM V-8 8.1 L	2003 - 2008
CHEVROLET	C6500	GM V-8 8.1 L	2003 - 2008
CHEVROLET	C7500	GM V-8 8.1 L	2003 - 2008

**38261**



CHEVROLET	KODIAK	GM V-8, 8.1 L	2001 - 2008
CHEVROLET	C8500	GM V-8 8.1 L	2001 - 2002
CHEVROLET	C5500	GM V-8 8.1 L	2001 - 2002
CHEVROLET	C6500	GM V-8 8.1 L	2001 - 2002
CHEVROLET	C7500	GM V-8 8.1 L	2001 - 2002

**38329**

Acero V-Ranurada 6 costillas (76 mm x 17 mm x 30 mm) -



FORD	E450 SUPER DUTY	Ford V-10 6.8 L	2006 - 2007
FORD	E450 SUPER DUTY	Ford V-8 5.4 L	2005 - 2005
FORD	F450 SUPER DUTY	Ford V-10 6.8 L	2002 - 2006
FORD	F550 SUPER DUTY	Ford V-10 6.8 L	2002 - 2006

**38274**

Acero Lisa/Posterior (76 mm x 17 mm x 30.5 mm)



FORD	F550 SUPER DUTY	Ford V-10 6.8 L	2002 - 2006
FORD	E450 SUPER DUTY	Ford V-10 6.8 L	2006 - 2007
FORD	E450 SUPER DUTY	Ford V-8 5.4 L	2003 - 2004
FORD	E450 SUPER DUTY	Ford V-8 5.4 L	2002 - 2002
FORD	F450 SUPER DUTY	Ford V-10 6.8 L	2002 - 2006

**38330**

Acero V-Ranurada 8 costillas (76 mm x 17 mm x 38 mm)



FORD	F550 SUPER DUTY	Ford V-10 6.8 L	1999 - 2001
FORD	F450 SUPER DUTY	Ford V-10 6.8 L	1999 - 2001
FORD	E450 SUPER DUTY	Ford V-10 6.8 L	1999 - 2005
FORD	E550 SUPER DUTY	Ford V-10 6.8 L	2002 - 2003

38501



FREIGHTLINER	CLASSIC XL	Detroit Diesel 6-Cyl. 12.7 L Diesel	2001 - 2007
FREIGHTLINER	CLASSIC XL	Detroit Diesel 6-Cyl. 14.0 L Diesel	2001 - 2008
FREIGHTLINER	COLUMBIA	Detroit Diesel 6-Cyl. 11.1 L Diesel	2000 - 2001
FREIGHTLINER	COLUMBIA	Detroit Diesel 6-Cyl. 12.7 L Diesel	2000 - 2008
FREIGHTLINER	COLUMBIA	Detroit Diesel 6-Cyl. 14.0 L Diesel	2002 - 2008
FREIGHTLINER	COLUMBIA	DETROIT DIESEL SERIE 60	2001 - 2001
FREIGHTLINER	COLUMBIA	DETROIT DIESEL SERIE 60	2003 - 2003
FREIGHTLINER	CORONADO	DETROIT DIESEL SERIE 60	2005 - 2005
FREIGHTLINER	COLUMBIA	DETROIT DIESEL SERIE 60	2004 - 2005
FREIGHTLINER	CENTURY CLASS	Detroit Diesel 6-Cyl. 11.1 L Diesel	1999 - 2003
FREIGHTLINER	COLUMBIA	DETROIT DIESEL SERIE 60	2006 - 2006
FREIGHTLINER	COLUMBIA	Mercedes-Benz MBE 4000 Diesel	2005 - 2007
FREIGHTLINER	CORONADO	Detroit Diesel 6-Cyl. 12.7 L Diesel	2002 - 2008
FREIGHTLINER	CORONADO	Detroit Diesel 6-Cyl. 14.0 L Diesel	2003 - 2008
FREIGHTLINER	CORONADO	DETROIT DIESEL SERIE 60	2004 - 2004
FREIGHTLINER	CORONADO	DETROIT DIESEL SERIE 60	2006 - 2006
FREIGHTLINER	CLASSIC XL	Detroit Diesel 6-Cyl. 11.1 L Diesel	2001 - 2002
FREIGHTLINER	FLD	Detroit Diesel 6-Cyl. 14.0 L Diesel	2001 - 2008
FREIGHTLINER	CENTURY CLASS	Detroit Diesel 6-Cyl. 12.7 L Diesel	1999 - 2007
FREIGHTLINER	FLD	Detroit Diesel 6-Cyl. 12.7 L Diesel	2000 - 2008
FREIGHTLINER	ARGOSY	Detroit Diesel 6-Cyl. 11.1 L Diesel	2000 - 2003
FREIGHTLINER	ARGOSY	Detroit Diesel 6-Cyl. 11.1 L Diesel	1999 - 1999
FREIGHTLINER	ARGOSY	Detroit Diesel 6-Cyl. 12.7 L Diesel	2000 - 2006
FREIGHTLINER	ARGOSY	Detroit Diesel 6-Cyl. 12.7 L Diesel	1999 - 1999
FREIGHTLINER	ARGOSY	Detroit Diesel 6-Cyl. 14.0 L Diesel	2003 - 2006
FREIGHTLINER	CENTURY CLASS	Detroit Diesel 6-Cyl. 14.0 L Diesel	2003 - 2007
FREIGHTLINER	CASCADIA	Detroit Diesel 6-Cyl. 14.0 L Diesel	2008 - 2008
FREIGHTLINER	CLASSIC	DETROIT DIESEL SERIE 60	2005 - 2005
FREIGHTLINER	CENTURY CLASS	DETROIT DIESEL SERIE 60	2005 - 2005
FREIGHTLINER	CENTURY CLASS	DETROIT DIESEL SERIE 60	2002 - 2003
FREIGHTLINER	CENTURY CLASS	Mercedes-Benz MBE 4000 Diesel	2001 - 2001
FREIGHTLINER	CENTURY CLASS	Mercedes-Benz MBE 4000 Diesel	2005 - 2005
FREIGHTLINER	CLASSIC	Detroit Diesel 6-Cyl. 11.1 L Diesel	2001 - 2002
FREIGHTLINER	CLASSIC	Detroit Diesel 6-Cyl. 12.7 L Diesel	2001 - 2007

FREIGHTLINER	CLASSIC	Detroit Diesel 6-Cyl. 14.0 L Diesel	2003 - 2008
FREIGHTLINER	BUSINESS CLASS M2	Mercedes-Benz MBE 4000 Diesel	2004 - 2007
STERLING	L-LINE	DETROIT DIESEL SERIE 60	2004 - 2005
FREIGHTLINER	FLD	Detroit Diesel 6-Cyl. 11.1 L Diesel	2000 - 2002
STERLING	L-LINE	Mercedes-Benz MBE 4000 Diesel	2003 - 2007
STERLING	L-LINE	DETROIT DIESEL SERIE 60	2002 - 2002
STERLING	L-LINE	Detroit Diesel 6-Cyl. 14.0 L Diesel	2004 - 2008
STERLING	L-LINE	Detroit Diesel 6-Cyl. 12.7 L Diesel	2002 - 2008
STERLING	L-LINE	Detroit Diesel 6-Cyl. 11.1 L Diesel	2002 - 2002
STERLING	A-LINE	Mercedes-Benz MBE 4000 Diesel	2004 - 2006
STERLING	A-LINE	Mercedes-Benz MBE 4000 Diesel	2008 - 2008
STERLING	A-LINE	DETROIT DIESEL SERIE 60	2005 - 2006
STERLING	A-LINE	DETROIT DIESEL SERIE 60	2002 - 2002
STERLING	A-LINE	DETROIT DIESEL SERIE 60	2004 - 2004
STERLING	A-LINE	Detroit Diesel 6-Cyl. 14.0 L Diesel	2004 - 2006
STERLING	A-LINE	Detroit Diesel 6-Cyl. 12.7 L Diesel	2001 - 2006
KENWORTH	T2000	Detroit Diesel 6-Cyl. 12.7 L Diesel	2000 - 2000
STERLING	L-LINE	DETROIT DIESEL SERIE 60	2006 - 2006
FREIGHTLINER	FLD	DETROIT DIESEL SERIE 60	2004 - 2004
FREIGHTLINER	FLD	DETROIT DIESEL SERIE 60	2006 - 2006
FREIGHTLINER	FLD	DETROIT DIESEL SERIE 60	2002 - 2003
STERLING	A-LINE	Detroit Diesel 6-Cyl. 11.1 L Diesel	2001 - 2002
KENWORTH	T2000	Detroit Diesel 6-Cyl. 11.1 L Diesel	2000 - 2000
KENWORTH	T800	Detroit Diesel 6-Cyl. 11.1 L Diesel	2000 - 2001
KENWORTH	T800	Detroit Diesel 6-Cyl. 12.7 L Diesel	2000 - 2001
KENWORTH	T800	DETROIT DIESEL SERIE 60	2001 - 2001
KENWORTH	W900	Detroit Diesel 6-Cyl. 11.1 L Diesel	2000 - 2001
KENWORTH	W900	Detroit Diesel 6-Cyl. 12.7 L Diesel	2000 - 2001
PETERBILT	379	Detroit Diesel 6-Cyl. 11.1 L Diesel	2000 - 2001
PETERBILT	379	Detroit Diesel 6-Cyl. 12.7 L Diesel	2000 - 2001
FREIGHTLINER	FLD120	DETROIT DIESEL SERIE 60	1999 - 2001

38502



STERLING	L-LINE	Detroit Diesel 6-Cyl. 11.1 L Diesel	2000 - 2001
STERLING	L-LINE	DETROIT DIESEL SERIE 60	2003 - 2003



STERLING	L-LINE	DETROIT DIESEL SERIE 60	2001 - 2001
STERLING	L-LINE	Detroit Diesel 6-Cyl. 14.0 L Diesel	2003 - 2003
STERLING	A-LINE	DETROIT DIESEL SERIE 60	2001 - 2001
STERLING	A-LINE	Detroit Diesel 6-Cyl. 12.7 L Diesel	2000 - 2000
STERLING	A-LINE	Detroit Diesel 6-Cyl. 11.1 L Diesel	2000 - 2000
STERLING	L-LINE	Detroit Diesel 6-Cyl. 12.7 L Diesel	2000 - 2001
STERLING	L-LINE	Detroit Diesel 6-Cyl. 12.7 L Diesel	2003 - 2003

**38503**



FREIGHTLINER	COLUMBIA	Detroit Diesel 6-Cyl. 14.0 L Diesel	2004 - 2008
FREIGHTLINER	CLASSIC XL	Detroit Diesel 6-Cyl. 14.0 L Diesel	2005 - 2008
FREIGHTLINER	CLASSIC XL	Detroit Diesel 6-Cyl. 12.7 L Diesel	2005 - 2007
FREIGHTLINER	CLASSIC	Detroit Diesel 6-Cyl. 14.0 L Diesel	2005 - 2008

**38504**



FREIGHTLINER	FL80	Cummins C Series 8.3 L Diesel	1997 - 1997
--------------	------	-------------------------------	-------------

**38505**



STERLING	L-LINE	Detroit Diesel 6-Cyl. 12.7 L Diesel	2004 - 2008
FREIGHTLINER	CORONADO	DETROIT DIESEL SERIE 60	2005 - 2005
FREIGHTLINER	CORONADO	DETROIT DIESEL SERIE 60	2004 - 2006
FREIGHTLINER	FLD	Detroit Diesel 6-Cyl. 12.7 L Diesel	2006 - 2005
FREIGHTLINER	FLD	Detroit Diesel 6-Cyl. 14.0 L Diesel	2006 - 2005
FREIGHTLINER	FLD	DETROIT DIESEL SERIE 60	2006 - 2006
STERLING	A-LINE	Detroit Diesel 6-Cyl. 12.7 L Diesel	2004 - 2006
STERLING	A-LINE	Detroit Diesel 6-Cyl. 14.0 L Diesel	2004 - 2006
STERLING	A-LINE	DETROIT DIESEL SERIE 60	2005 - 2006
STERLING	L-LINE	Detroit Diesel 6-Cyl. 14.0 L Diesel	2004 - 2008
STERLING	L-LINE	DETROIT DIESEL SERIE 60	2004 - 2005
STERLING	L-LINE	DETROIT DIESEL SERIE 60	2006 - 2006
FREIGHTLINER	CLASSIC	Detroit Diesel 6-Cyl. 12.7 L Diesel	2005 - 2007
FREIGHTLINER	CORONADO	Detroit Diesel 6-Cyl. 14.0 L Diesel	2003 - 2008
STERLING	A-LINE	DETROIT DIESEL SERIE 60	2004 - 2005
FREIGHTLINER	CASCADIA	Detroit Diesel 6-Cyl. 14.0 L Diesel	2008 - 2008
FREIGHTLINER	CLASSIC	DETROIT DIESEL SERIE 60	2005 - 2005
FREIGHTLINER	CORONADO	Detroit Diesel 6-Cyl. 12.7 L Diesel	2002 - 2008
FREIGHTLINER	ARGOSY	Detroit Diesel 6-Cyl. 11.1 L Diesel	2000 - 2003
FREIGHTLINER	ARGOSY	Detroit Diesel 6-Cyl. 14.0 L Diesel	2003 - 2006
FREIGHTLINER	CENTURY CLASS	Detroit Diesel 6-Cyl. 12.7 L Diesel	2004 - 2007
FREIGHTLINER	CENTURY CLASS	Detroit Diesel 6-Cyl. 14.0 L Diesel	2004 - 2007
FREIGHTLINER	CENTURY CLASS	DETROIT DIESEL SERIE 60	2005 - 2005
FREIGHTLINER	COLUMBIA	Detroit Diesel 6-Cyl. 12.7 L Diesel	2004 - 2008
FREIGHTLINER	COLUMBIA	DETROIT DIESEL SERIE 60	2006 - 2005
FREIGHTLINER	ARGOSY	Detroit Diesel 6-Cyl. 12.7 L Diesel	2000 - 2006

VOLVO	VNL 64T 420 6X4 TIPICO	DETROIT DIESEL SERIE 60	1999 - 2000
PETERBILT	357	Cummins ISM Diesel	2001 - 2007
KENWORTH	T600	Cummins ISM Diesel	2004 - 2004
KENWORTH	T2000	Caterpillar C12 Diesel	1998 - 1999
KENWORTH	T800B AEROCAB	CATERPILLAR C10 DIESEL	1999 - 2000
KENWORTH	T800B AEROCAB	CATERPILLAR C12 DIESEL	1999 - 2000
KENWORTH	T800SH AEROCAB	CATERPILLAR C10 DIESEL	1999 - 2000
KENWORTH	T800SH AEROCAB	CATERPILLAR C12 DIESEL	1999 - 2000
KENWORTH	W900	Cummins ISM Diesel	2003 - 2006
PETERBILT	320	Cummins ISM Diesel	2007 - 2007
KENWORTH	T800	Cummins ISM Diesel	2003 - 2006
PETERBILT	365	Cummins ISM Diesel	2007 - 2007
PETERBILT	378	Cummins ISM Diesel	2001 - 2007
PETERBILT	385	Cummins ISM Diesel	2002 - 2005
PETERBILT	387	Cummins ISM Diesel	2000 - 2000
VOLVO	AUTOCAR	Detroit Diesel 6-Cyl. 11.1 L Diesel	1998 - 1998
VOLVO	AUTOCAR	Detroit Diesel 6-Cyl. 12.7 L Diesel	1998 - 1998
VOLVO	VN SERIES	Caterpillar 3406 Diesel	1999 - 1999
VOLVO	VN SERIES	Detroit Diesel 6-Cyl. 12.7 L Diesel	1998 - 2001
VOLVO	VNL 64T 610	DETROIT DIESEL SERIE 60	1999 - 2000

VOLVO	VNL 64T 420	DETROIT DIESEL SERIE 60	2001 - 2001
KENWORTH	T2000	Caterpillar C10 Diesel	1997 - 1999
VOLVO	VN SERIES	Detroit Diesel 6-Cyl. 11.1 L Diesel	1998 - 2001
FREIGHTLINER	CLASSIC XL	Cummins ISM Diesel	2001 - 2003
VOLVO	VNL 64T 420 STANDAR	DETROIT DIESEL SERIE 60	1999 - 2000
INTERNATIONAL/NAVISTAR	WORKSTAR 7600	Cummins ISM Diesel	2008 - 2008
FREIGHTLINER	CENTURY CLASS	Cummins ISM Diesel	1999 - 2001
FREIGHTLINER	CENTURY CLASS	Caterpillar C12 Diesel	1998 - 1998
FREIGHTLINER	COLUMBIA	Cummins ISM Diesel	2001 - 2003
FREIGHTLINER	CONDOR	Cummins ISM Diesel	2001 - 2002
FREIGHTLINER	FL112	CUMMINS ISM DIESEL	2002 - 2003
FREIGHTLINER	FL112	Cummins ISM Diesel	1999 - 2003
FREIGHTLINER	FL112	DETROIT DIESEL SERIE 50	1999 - 1999
FREIGHTLINER	FLD	Cummins ISM Diesel	1999 - 2003
INTERNATIONAL/NAVISTAR	5500	CUMMINS ISM DIESEL	2005 - 2005
INTERNATIONAL/NAVISTAR	9400i	Cummins ISM Diesel	2004 - 2007
FREIGHTLINER	CLASSIC	Cummins ISM Diesel	2001 - 2003
INTERNATIONAL/NAVISTAR	TRANSTAR 8600	Cummins ISM Diesel	2008 - 2008
INTERNATIONAL/NAVISTAR	5500i	Cummins ISM Diesel	2002 - 2006
INTERNATIONAL/NAVISTAR	9200i	Cummins ISM Diesel	2003 - 2007
INTERNATIONAL/NAVISTAR	9200	CUMMINS ISM DIESEL	2005 - 2005
INTERNATIONAL/NAVISTAR	8600	Cummins ISM Diesel	2003 - 2007
INTERNATIONAL/NAVISTAR	7600	Cummins ISM Diesel	2003 - 2007
INTERNATIONAL/NAVISTAR	7400	Cummins ISM Diesel	2005 - 2005
INTERNATIONAL/NAVISTAR	5900i	Cummins ISM Diesel	2001 - 2006
INTERNATIONAL/NAVISTAR	5600i	Cummins ISM Diesel	2002 - 2007
INTERNATIONAL/NAVISTAR	5600	CUMMINS ISM DIESEL	2005 - 2005
INTERNATIONAL/NAVISTAR	7700	Cummins ISM Diesel	2005 - 2006

KENWORTH	T600	Caterpillar C10 Diesel	1997 - 2004
INTERNATIONAL/NAVISTAR	9400	Caterpillar 3176 Diesel	1995 - 1995
INTERNATIONAL/NAVISTAR	9300	Caterpillar 3176 Diesel	1995 - 1995
INTERNATIONAL/NAVISTAR	9200i	Caterpillar C12 Diesel	2004 - 2004
INTERNATIONAL/NAVISTAR	9200i	Caterpillar C10 Diesel	2004 - 2004
INTERNATIONAL/NAVISTAR	7600	Caterpillar C10 Diesel	2002 - 2004
INTERNATIONAL/NAVISTAR	8600	Caterpillar C12 Diesel	2003 - 2004
INTERNATIONAL/NAVISTAR	8100	Caterpillar C10 Diesel	2002 - 2003
INTERNATIONAL/NAVISTAR	5900i	Caterpillar C10 Diesel	2000 - 2003
INTERNATIONAL/NAVISTAR	5600i	Caterpillar C12 Diesel	2003 - 2004
KENWORTH	T800	Caterpillar C12 Diesel	1996 - 2004
PETERBILT	385	Caterpillar C12 Diesel	1996 - 2004
INTERNATIONAL/NAVISTAR	9200	Caterpillar 3176 Diesel	1995 - 1995
PETERBILT	379	Caterpillar C10 Diesel	2002 - 2004
STERLING	A-LINE	Caterpillar C12 Diesel	2002 - 2004
STERLING	A-LINE	Caterpillar C10 Diesel	2002 - 2004
PETERBILT	387	Caterpillar C16 Diesel	2001 - 2003
PETERBILT	387	Caterpillar C15 Diesel	2001 - 2003
PETERBILT	387	Caterpillar C12 Diesel	2000 - 2002
PETERBILT	387	Caterpillar C10 Diesel	2000 - 2002
INTERNATIONAL/NAVISTAR	5900i	Caterpillar C12 Diesel	2002 - 2004
PETERBILT	379	Caterpillar C12 Diesel	2002 - 2004
INTERNATIONAL/NAVISTAR	5600i	Caterpillar C10 Diesel	2002 - 2004
KENWORTH	T800	Caterpillar C15 Diesel	2004 - 2004
PETERBILT	378	Caterpillar C12 Diesel	2002 - 2004
PETERBILT	378	Caterpillar C10 Diesel	2002 - 2004
PETERBILT	377	Caterpillar C12 Diesel	1997 - 1998
PETERBILT	377	Caterpillar C10 Diesel	1997 - 1998
PETERBILT	362	Caterpillar C12 Diesel	1996 - 1998
PETERBILT	362	Caterpillar C10 Diesel	1996 - 1998
PETERBILT	357	Caterpillar C12 Diesel	1997 - 2004
PETERBILT	357	Caterpillar C10 Diesel	1997 - 2004
PETERBILT	385	Caterpillar C10 Diesel	1997 - 2004
FREIGHTLINER	CENTURY CLASS	Caterpillar C12 Diesel	1999 - 2004
FREIGHTLINER	COLUMBIA	Caterpillar C12 Diesel	2003 - 2004
FREIGHTLINER	COLUMBIA	Caterpillar C10 Diesel	2001 - 2003
FREIGHTLINER	CLASSIC XL	Caterpillar C16 Diesel	2001 - 2003
FREIGHTLINER	CLASSIC XL	Caterpillar C15 Diesel	2001 - 2006
FREIGHTLINER	CLASSIC	Caterpillar C16 Diesel	2001 - 2003
FREIGHTLINER	CLASSIC	Caterpillar C15 Diesel	2001 - 2006
FREIGHTLINER	CENTURY CLASS	DETROIT DIESEL SERIE 60	2003 - 2003

38506

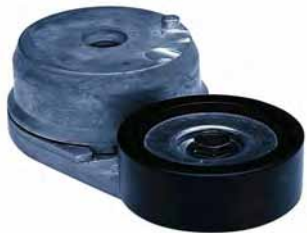

INTERNATIONAL/NAVISTAR	8600	Caterpillar C10 Diesel	2003 - 2004
KENWORTH	T800	Caterpillar C10 Diesel	1997 - 2004
KENWORTH	T600	Caterpillar C15 Diesel	2000 - 2005
KENWORTH	T600	Caterpillar C15 Diesel	2006 - 2006
KENWORTH	T600	Caterpillar C12 Diesel	1996 - 2004

FREIGHTLINER	COLUMBIA	Caterpillar C15 Diesel	2001 - 2003
FREIGHTLINER	CENTURY CLASS	Caterpillar C12 Diesel	2000 - 2000
FREIGHTLINER	ARGOSY	Caterpillar C12 Diesel	2000 - 2004
FREIGHTLINER	CENTURY CLASS	Caterpillar C10 Diesel	2000 - 2000
FREIGHTLINER	CENTURY CLASS	Caterpillar C10 Diesel	1998 - 2003
FREIGHTLINER	CENTURY CLASS	Caterpillar 3406 Diesel	1998 - 1999
FREIGHTLINER	ARGOSY	Caterpillar C15 Diesel	2001 - 2004
INTERNATIONAL/NAVISTAR	5500i	Caterpillar C12 Diesel	2003 - 2004
FREIGHTLINER	ARGOSY	Caterpillar C10 Diesel	2000 - 2003
INTERNATIONAL/NAVISTAR	7600	Caterpillar C12 Diesel	2002 - 2004
FORD	F650 SUPER DUTY	Caterpillar 3126 Diesel	2000 - 2004
FREIGHTLINER	CENTURY CLASS	Caterpillar C15 Diesel	2001 - 2004
FREIGHTLINER	FLD	Caterpillar C12 Diesel	2000 - 2000
FORD	F750 SUPER DUTY	Caterpillar 3126 Diesel	2000 - 2004
FREIGHTLINER	COLUMBIA	Caterpillar C16 Diesel	2001 - 2004
INTERNATIONAL/NAVISTAR	5500i	Caterpillar C10 Diesel	2003 - 2004
INTERNATIONAL/NAVISTAR	5000	Caterpillar C12 Diesel	1998 - 1999
FREIGHTLINER	FLD	Caterpillar C15 Diesel	2000 - 2004
FREIGHTLINER	FLD	Caterpillar C12 Diesel	1998 - 2004
FREIGHTLINER	FLD	Caterpillar C10 Diesel	2000 - 2000
FREIGHTLINER	FLD	Caterpillar C10 Diesel	1998 - 2004
FREIGHTLINER	FLD	CATERPILLAR 3406 E DIESEL	1999 - 2000
FREIGHTLINER	FL112	Caterpillar C12 Diesel	2000 - 2004
FREIGHTLINER	FL112	Caterpillar C12 Diesel	1999 - 1999
FREIGHTLINER	FL112	Caterpillar C10 Diesel	2000 - 2004
FREIGHTLINER	FL112	Caterpillar C10 Diesel	1999 - 1999
FREIGHTLINER	CORONADO	Caterpillar C16 Diesel	2002 - 2003
FREIGHTLINER	CORONADO	Caterpillar C15 Diesel	2002 - 2004
FREIGHTLINER	FLD	Caterpillar 3406 Diesel	1998 - 2000
FREIGHTLINER	CONDOR	Caterpillar C10 Diesel	2001 - 2004
FREIGHTLINER	FLD	Caterpillar C16 Diesel	2000 - 2004
FREIGHTLINER	CONDOR	Caterpillar C12 Diesel	2001 - 2004

**38507**



PETERBILT	357	Caterpillar 3126 Diesel	1998 - 1999
-----------	-----	-------------------------	-------------

INTERNATIONAL/NAVISTAR	8600	Caterpillar C10 Diesel	2003 - 2004
INTERNATIONAL/NAVISTAR	8600	Caterpillar C12 Diesel	2003 - 2004
INTERNATIONAL/NAVISTAR	9200i	Caterpillar C10 Diesel	2004 - 2004
INTERNATIONAL/NAVISTAR	9200i	Caterpillar C12 Diesel	2004 - 2004
PETERBILT	320	Cummins C Series 8.3 L Diesel	1996 - 1996
PETERBILT	320	Cummins ISC Diesel	1997 - 1997
PETERBILT	330	Caterpillar 3126 Diesel	1995 - 1997
INTERNATIONAL/NAVISTAR	8100	Caterpillar C10 Diesel	2002 - 2003
THOMAS BUILT	SAF-T-LINER MVP ER	John Deere 6-Cyl. 8.1 L CNG	2004 - 2006
PETERBILT	330	Caterpillar 3116 Diesel	1995 - 1998
BLUEBIRD	ALL AMERICAN RE	John Deere 6-Cyl. 8.1 L CNG	2003 - 2003
THOMAS BUILT	SAF-T-LINER MVP ER	John Deere 6-Cyl. 8.1 L CNG	2001 - 2001
INTERNATIONAL/NAVISTAR	7600	Caterpillar C12 Diesel	2002 - 2003
BLUEBIRD	ALL AMERICAN RE	John Deere 6-Cyl. 8.1 L CNG	1998 - 2002
BLUEBIRD	ALL AMERICAN RE	John Deere 6-Cyl. 8.1 L Diesel	2006 - 2006
THOMAS BUILT	SAF-T-LINER MVP ER	John Deere 6-Cyl. 8.1 L CNG	2002 - 2002
THOMAS BUILT	SAF-T-LINER MVP ER	John Deere 6-Cyl. 8.1 L CNG	2007 - 2007
THOMAS BUILT	SAF-T-LINER MVP ER	John Deere 6-Cyl. 8.1 L CNG	2003 - 2003
FREIGHTLINER	CENTURY CLASS	Cummins ISM Diesel	1998 - 1998
INTERNATIONAL/NAVISTAR	7600	Caterpillar C10 Diesel	2002 - 2003

**38508**



PETERBILT	387	Caterpillar C16 Diesel	2001 - 2003
FREIGHTLINER	FLD	Caterpillar C15 Diesel	2000 - 2004
FREIGHTLINER	FL80	Caterpillar C7 Diesel	2004 - 2005
FREIGHTLINER	FLD	Caterpillar 3406 Diesel	1998 - 2000
FREIGHTLINER	FLD	CATERPILLAR 3406 E DIESEL	1999 - 2000
FREIGHTLINER	FL70	Caterpillar C7 Diesel	2004 - 2005
FREIGHTLINER	FLD	Caterpillar C16 Diesel	2000 - 2004
KENWORTH	T600	Caterpillar C15 Diesel	2005 - 2006
KENWORTH	T600	Caterpillar C15 Diesel	2000 - 2004
PETERBILT	387	Caterpillar C15 Diesel	2001 - 2003
FREIGHTLINER	FL60	Caterpillar C7 Diesel	2004 - 2005
KENWORTH	T800	Caterpillar C15 Diesel	2004 - 2004
FREIGHTLINER	CLASSIC	Caterpillar C15 Diesel	2001 - 2006

FREIGHTLINER	CENTURY CLASS	Caterpillar 3406 Diesel	1998 - 1999
FREIGHTLINER	ARGOSY	Caterpillar C15 Diesel	2001 - 2004
FREIGHTLINER	CENTURY CLASS	Caterpillar C15 Diesel	2001 - 2004
FREIGHTLINER	CLASSIC	Caterpillar C16 Diesel	2001 - 2003
FREIGHTLINER	CLASSIC XL	Caterpillar C15 Diesel	2001 - 2006
FREIGHTLINER	CLASSIC XL	Caterpillar C16 Diesel	2001 - 2003
FREIGHTLINER	COLUMBIA	Caterpillar C15 Diesel	2001 - 2003
FREIGHTLINER	COLUMBIA	Caterpillar C16 Diesel	2001 - 2004
FREIGHTLINER	CORONADO	Caterpillar C15 Diesel	2002 - 2004
FREIGHTLINER	CORONADO	Caterpillar C16 Diesel	2002 - 2003
FREIGHTLINER	FL50	Caterpillar C7 Diesel	2004 - 2004

**38509**



CHEVROLET	KODIAK C6500	Caterpillar 3116 Diesel	1991 - 1996
CHEVROLET	C7500	Caterpillar 3126 Diesel	1998 - 2002
CHEVROLET	KODIAK C7500	Caterpillar 3116 Diesel	1991 - 1996
CHEVROLET	KODIAK	CATERPILLAR 3126 DIESEL	2000 - 2008
CHEVROLET	KODIAK	CATERPILLAR 3116 DIESEL	1997 - 2000
CHEVROLET	C8500	Caterpillar 3126 Diesel	1998 - 2002
CHEVROLET	C8500	Caterpillar 3116 Diesel	1997 - 2000
CHEVROLET	C6500	Caterpillar 3126 Diesel	1998 - 2002
CHEVROLET	C6500	Caterpillar 3116 Diesel	1997 - 2000
CHEVROLET	C5500	Caterpillar 3126 Diesel	1998 - 2002
CHEVROLET	C5500	Caterpillar 3116 Diesel	1999 - 1999
BLUEBIRD	ALL AMERICAN RE	Caterpillar C7 Diesel	2005 - 2006
BLUEBIRD	ALL AMERICAN FE	Caterpillar C7 Diesel	2005 - 2006
BLUEBIRD	ALL AMERICAN RE	Caterpillar 3126 Diesel	2003 - 2004
CHEVROLET	KODIAK C8500	Caterpillar 3116 Diesel	1991 - 1996
CHEVROLET	C7500	Caterpillar 3116 Diesel	1997 - 2000

**38510**



INTERNATIONAL/NAVISTAR	CONVENTIONAL IC	International/Navistar T444 Diesel	2003 - 2003
INTERNATIONAL/NAVISTAR	4800	International/Navistar T444 Diesel	1995 - 1997
INTERNATIONAL/NAVISTAR	4700	International/Navistar T444 Diesel	1995 - 2002
INTERNATIONAL/NAVISTAR	CONVENTIONAL IC	International/Navistar T444 Diesel	2002 - 2002
INTERNATIONAL/NAVISTAR	CE	International/Navistar T444 Diesel	2003 - 2004
INTERNATIONAL/NAVISTAR	3800	International/Navistar T444 Diesel	2002 - 2001
INTERNATIONAL/NAVISTAR	4900	International/Navistar T444 Diesel	1995 - 1997
INTERNATIONAL/NAVISTAR	4600	International/Navistar T444 Diesel	1995 - 1995

**38511**



INTERNATIONAL/NAVISTAR	9900i	Caterpillar C15 Diesel	2004 - 2007
INTERNATIONAL/NAVISTAR	8100	International/Navistar 530 Diesel	1995 - 1995
KENWORTH	T300	Caterpillar 3126 Diesel	1998 - 2003
KENWORTH	T600	Caterpillar C15 Diesel	2007 - 2007
KENWORTH	T300	Caterpillar 3126 Diesel	1996 - 1997
KENWORTH	T2000	Caterpillar C15 Diesel	2004 - 2007
INTERNATIONAL/NAVISTAR	PAYSTAR 5600i	Caterpillar C15 Diesel	2008 - 2008
INTERNATIONAL/NAVISTAR	9900ix	Caterpillar C15 Diesel	2004 - 2007
INTERNATIONAL/NAVISTAR	9400i	Caterpillar C15 Diesel	2004 - 2007
INTERNATIONAL/NAVISTAR	8500	International/Navistar 530 Diesel	2002 - 2005
INTERNATIONAL/NAVISTAR	8100	International/Navistar 530 Diesel	1995 - 1998
INTERNATIONAL/NAVISTAR	8200	International/Navistar DT466 Diesel	1997 - 1997
INTERNATIONAL/NAVISTAR	8200	International/Navistar 530 Diesel	1996 - 1997
INTERNATIONAL/NAVISTAR	8200	Detroit Diesel 6-Cyl. 12.7 L Diesel	1995 - 1995
INTERNATIONAL/NAVISTAR	8100	International/Navistar DT466 Diesel	1995 - 2000
KENWORTH	T800	Caterpillar C15 Diesel	2005 - 2007
INTERNATIONAL/NAVISTAR	8200	Detroit Diesel 6-Cyl. 11.1 L Diesel	1995 - 1995

PETERBILT	379	Caterpillar C15 Diesel	2004 - 2004
STERLING	L-LINE	Caterpillar C7 Diesel	2004 - 2004
STERLING	ACTERRA	CATERPILLAR 3126 DIESEL	2003 - 2003
STERLING	L-LINE	Caterpillar 3126 Diesel	2000 - 2004
INTERNATIONAL/NAVISTAR	7500	International/Navistar DT530 Diesel	2004 - 2005
STERLING	L-LINE	CATERPILLAR 3126 DIESEL	2001 - 2002
STERLING	ACTERRA	Caterpillar C7 Diesel	2004 - 2004
STERLING	ACTERRA	Caterpillar 3126 Diesel	2001 - 2004
STERLING	L-LINE	CATERPILLAR 3126 DIESEL	2003 - 2003
PETERBILT	386	Caterpillar C15 Diesel	2006 - 2007
KENWORTH	W900	Caterpillar C15 Diesel	2004 - 2007
PETERBILT	379	Caterpillar C15 Diesel	2005 - 2007
PETERBILT	378	Caterpillar C15 Diesel	2003 - 2004
PETERBILT	378	Caterpillar C15 Diesel	2006 - 2006
PETERBILT	378	Caterpillar C15 Diesel	2005 - 2007
PETERBILT	357	Caterpillar C15 Diesel	2006 - 2006
PETERBILT	357	Caterpillar C15 Diesel	2004 - 2007
PETERBILT	330	Caterpillar 3126 Diesel	1998 - 2003
PETERBILT	387	Caterpillar C15 Diesel	2004 - 2007
FREIGHTLINER	CENTURY CLASS	Caterpillar C15 Diesel	2005 - 2006
FREIGHTLINER	FL70	Caterpillar C7 Diesel	2004 - 2005
FREIGHTLINER	FL60	Caterpillar C7 Diesel	2004 - 2005
FREIGHTLINER	FL60	Caterpillar 3126 Diesel	1995 - 2004
FREIGHTLINER	FL50	Caterpillar 3126 Diesel	1995 - 2004
FREIGHTLINER	CORONADO	Caterpillar C15 Diesel	2005 - 2006
FREIGHTLINER	COLUMBIA	Caterpillar C15 Diesel	2005 - 2005
FREIGHTLINER	FL80	Caterpillar C7 Diesel	2004 - 2005
FREIGHTLINER	CLASSIC XL	Caterpillar C15 Diesel	2005 - 2005
FREIGHTLINER	FL80	Caterpillar 3126 Diesel	1995 - 2005
THOMAS BUILT	SAF-T-LINER MVP ER	Caterpillar 3126 Diesel	2001 - 2003
THOMAS BUILT	SAF-T-LINER MVP ER	Caterpillar 3126 Diesel	2004 - 2004
THOMAS BUILT	SAF-T-LINER MVP EF	Caterpillar 3126 Diesel	1998 - 2004
THOMAS BUILT	CONVENTIONAL	Caterpillar 3126 Diesel	1998 - 2003
BLUEBIRD	TC2000	Caterpillar 3126 Diesel	1998 - 1998
STERLING	ACTERRA	CATERPILLAR C7 DIESEL	2004 - 2004
INTERNATIONAL/NAVISTAR	7500	International/Navistar DT466 Diesel	2002 - 2002
FREIGHTLINER	COLUMBIA	CATERPILLAR C15 DIESEL	2005 - 2005
INTERNATIONAL/NAVISTAR	4900	International/Navistar DT466 Diesel	1995 - 1999
INTERNATIONAL/NAVISTAR	7500	International/Navistar 530 Diesel	2002 - 2003
INTERNATIONAL/NAVISTAR	7400	International/Navistar DT530 Diesel	2004 - 2005
INTERNATIONAL/NAVISTAR	7400	International/Navistar DT466 Diesel	2002 - 2003

INTERNATIONAL/NAVISTAR	7400	International/Navistar 530 Diesel	2002 - 2003
INTERNATIONAL/NAVISTAR	7300	International/Navistar DT466 Diesel	2002 - 2003
INTERNATIONAL/NAVISTAR	7100	International/Navistar DT466 Diesel	1995 - 1995
FREIGHTLINER	FL70	Caterpillar 3126 Diesel	1995 - 2004
INTERNATIONAL/NAVISTAR	5600i	Caterpillar C15 Diesel	2004 - 2004
FREIGHTLINER	FLD	Caterpillar C15 Diesel	2005 - 2008
INTERNATIONAL/NAVISTAR	4900	International/Navistar DT408 Diesel	1995 - 1997
INTERNATIONAL/NAVISTAR	4800	International/Navistar DT466 Diesel	1995 - 2003
INTERNATIONAL/NAVISTAR	4800	International/Navistar DT408 Diesel	1995 - 1997
INTERNATIONAL/NAVISTAR	4700	International/Navistar DT466 Diesel	1995 - 1999
INTERNATIONAL/NAVISTAR	4700	International/Navistar DT408 Diesel	1995 - 1997
INTERNATIONAL/NAVISTAR	4400	International/Navistar DT466 Diesel	2002 - 2005
INTERNATIONAL/NAVISTAR	4400	International/Navistar 530 Diesel	2002 - 2005
INTERNATIONAL/NAVISTAR	4300	International/Navistar DT466 Diesel	2002 - 2004
INTERNATIONAL/NAVISTAR	5900i	Caterpillar C15 Diesel	2004 - 2006

**38512**



INTERNATIONAL/NAVISTAR	4900	International/Navistar DT466 Diesel	2002 - 2002
INTERNATIONAL/NAVISTAR	4800	International/Navistar 530 Diesel	2002 - 2002
INTERNATIONAL/NAVISTAR	8100	International/Navistar 530 Diesel	1999 - 2003
INTERNATIONAL/NAVISTAR	5600i	International/Navistar DT466 Diesel	2001 - 2002
INTERNATIONAL/NAVISTAR	5500i	International/Navistar DT466 Diesel	2001 - 2002
INTERNATIONAL/NAVISTAR	4900	INTERNATIONAL/NAVISTAR DT530E	2001 - 2001
INTERNATIONAL/NAVISTAR	4900	International/Navistar 530 Diesel	1995 - 2002
INTERNATIONAL/NAVISTAR	4700	International/Navistar 530 Diesel	1999 - 2002
INTERNATIONAL/NAVISTAR	4700 SCD	INTERNATIONAL/NAVISTAR DT466 DIESEL	1999 - 2001
INTERNATIONAL/NAVISTAR	4700 FBC	INTERNATIONAL/NAVISTAR DT466 DIESEL	1999 - 2000
INTERNATIONAL/NAVISTAR	4700	International/Navistar DT466 Diesel	2000 - 2002
INTERNATIONAL/NAVISTAR	4900	International/Navistar DT466 Diesel	2000 - 2001

**38513**



FREIGHTLINER	FL80	Cummins ISC Diesel	1998 - 1998
STERLING	L-LINE	Cummins ISC Diesel	2000 - 2003
FREIGHTLINER	FL80	Cummins ISC Diesel	1999 - 1999
FREIGHTLINER	FL70	Cummins ISC Diesel	1998 - 1998
FREIGHTLINER	FL60	Cummins ISC Diesel	1998 - 1998
BLUEBIRD	ALL AMERICAN RE	Cummins ISC Diesel	1999 - 2000
THOMAS BUILT	SAF-T-LINER MVP ER	Cummins ISC Diesel	1998 - 1998
THOMAS BUILT	SAF-T-LINER MVP EF	Cummins ISB Diesel	2000 - 2002
BLUEBIRD	ALL AMERICAN RE	Cummins ISC Diesel	1998 - 1998
FREIGHTLINER	FL50	Cummins ISC Diesel	1998 - 1998
KENWORTH	T300	Cummins ISC Diesel	1999 - 1999

**38514**



INTERNATIONAL/NAVISTAR	7500	International/Navistar 530 Diesel	2002 - 2003
INTERNATIONAL/NAVISTAR	7400	International/Navistar DT530 Diesel	2004 - 2005
INTERNATIONAL/NAVISTAR	7400	International/Navistar DT466 Diesel	2002 - 2003
INTERNATIONAL/NAVISTAR	7400	International/Navistar 530 Diesel	2002 - 2003
INTERNATIONAL/NAVISTAR	7300	International/Navistar DT466 Diesel	2002 - 2003
INTERNATIONAL/NAVISTAR	4900	International/Navistar DT466 Diesel	1995 - 2002
INTERNATIONAL/NAVISTAR	5600i	International/Navistar DT466 Diesel	2001 - 2002
INTERNATIONAL/NAVISTAR	5500i	International/Navistar DT466 Diesel	2001 - 2002
INTERNATIONAL/NAVISTAR	4900	INTERNATIONAL/NAVISTAR AR DT530E	2001 - 2001
INTERNATIONAL/NAVISTAR	7500	International/Navistar DT466 Diesel	2002 - 2002
PETERBILT	378	Caterpillar C10 Diesel	2000 - 2001
INTERNATIONAL/NAVISTAR	7100	International/Navistar DT466 Diesel	1995 - 1995
INTERNATIONAL/NAVISTAR	7500	International/Navistar DT530 Diesel	2004 - 2005
INTERNATIONAL/NAVISTAR	8100	Caterpillar 3176 Diesel	1995 - 1997

INTERNATIONAL/NAVISTAR	8100	International/Navistar 530 Diesel	1996 - 2003
INTERNATIONAL/NAVISTAR	8100	International/Navistar DT466 Diesel	1995 - 2000
PETERBILT	379	Caterpillar C12 Diesel	2000 - 2001
INTERNATIONAL/NAVISTAR	8200	International/Navistar 530 Diesel	1996 - 1997
INTERNATIONAL/NAVISTAR	8500	International/Navistar 530 Diesel	2002 - 2005
INTERNATIONAL/NAVISTAR	4900	International/Navistar DT408 Diesel	1995 - 1997
PETERBILT	378	Caterpillar C12 Diesel	2000 - 2001
PETERBILT	379	Caterpillar C10 Diesel	2000 - 2001
INTERNATIONAL/NAVISTAR	CONVENTIONAL IC	International/Navistar DT466 Diesel	2002 - 2003
INTERNATIONAL/NAVISTAR	8200	International/Navistar DT466 Diesel	1997 - 1997
INTERNATIONAL/NAVISTAR	FE	International/Navistar DT466 Diesel	2002 - 2004
INTERNATIONAL/NAVISTAR	RE	International/Navistar 530 Diesel	1998 - 2004
INTERNATIONAL/NAVISTAR	4900	International/Navistar 530 Diesel	1995 - 2002
BLUEBIRD	CONVENTIONAL	International/Navistar DT466 Diesel	1999 - 2004
INTERNATIONAL/NAVISTAR	3300	International/Navistar DT466 Diesel	2004 - 2004
INTERNATIONAL/NAVISTAR	3800	International/Navistar DT466 Diesel	1998 - 1999
INTERNATIONAL/NAVISTAR	CE	International/Navistar DT466 Diesel	2003 - 2004
FREIGHTLINER	FLD	Caterpillar C10 Diesel	1997 - 1997
FREIGHTLINER	FLD	Caterpillar C12 Diesel	1996 - 1997
INTERNATIONAL/NAVISTAR	4300	International/Navistar DT466 Diesel	2002 - 2004
INTERNATIONAL/NAVISTAR	4400	International/Navistar 530 Diesel	2002 - 2005
INTERNATIONAL/NAVISTAR	4700 SCD	INTERNATIONAL/NAVISTAR AR DT466 DIESEL	1999 - 1999
INTERNATIONAL/NAVISTAR	4800	International/Navistar DT466 Diesel	1995 - 2003
INTERNATIONAL/NAVISTAR	3800	International/Navistar DT466 Diesel	2000 - 2001
INTERNATIONAL/NAVISTAR	4400	International/Navistar DT466 Diesel	2002 - 2005
INTERNATIONAL/NAVISTAR	4800	International/Navistar 530 Diesel	2002 - 2002
INTERNATIONAL/NAVISTAR	4700 SCD	INTERNATIONAL/NAVISTAR AR DT466 DIESEL	2000 - 2001
INTERNATIONAL/NAVISTAR	4800	International/Navistar DT408 Diesel	1995 - 1997
INTERNATIONAL/NAVISTAR	4700 FBC	INTERNATIONAL/NAVISTAR AR DT466 DIESEL	2000 - 2000
INTERNATIONAL/NAVISTAR	4700 FBC	INTERNATIONAL/NAVISTAR AR DT466 DIESEL	1999 - 1999
INTERNATIONAL/NAVISTAR	4700	International/Navistar DT466 Diesel	1995 - 2002
INTERNATIONAL/NAVISTAR	4700	International/Navistar DT408 Diesel	1995 - 1997
INTERNATIONAL/NAVISTAR	4700	International/Navistar 530 Diesel	1999 - 2002

**38516**



FREIGHTLINER	FL70	Cummins ISC Diesel	1999 - 2005
FREIGHTLINER	FL70	Cummins ISB Diesel	2000 - 2001
FREIGHTLINER	FL70	Cummins ISB Diesel	1998 - 1999
FREIGHTLINER	FL70	Cummins ISB Diesel	2002 - 2003
FREIGHTLINER	FL80	Cummins B Series 5.9 L Diesel	1997 - 1997
FREIGHTLINER	FL70	Cummins B Series 5.9 L Diesel	1997 - 1997
FREIGHTLINER	FL60	Cummins ISC Diesel	1999 - 2004
FREIGHTLINER	FL60	Cummins ISB Diesel	1998 - 1999
FREIGHTLINER	FL60	Cummins ISB Diesel	2000 - 2001
FREIGHTLINER	FL80	Cummins ISB Diesel	2002 - 2003
STERLING	L-LINE	Cummins ISB Diesel	2000 - 2000
FREIGHTLINER	FL60	Cummins ISB Diesel	2002 - 2003
FREIGHTLINER	FL80	Cummins ISB Diesel	1998 - 1999
FREIGHTLINER	FL80	Cummins ISC Diesel	2002 - 2005
KENWORTH	T300	Cummins ISC Diesel	2005 - 2005
KENWORTH	T300	Cummins ISC Diesel	2006 - 2006
KENWORTH	T300	Cummins ISC Diesel	2001 - 2004
KENWORTH	T800	CUMMINS ISL	2006 - 2006
KENWORTH	T800	CUMMINS ISL	2005 - 2005
KENWORTH	T800	Cummins ISL Diesel	2001 - 2008
KENWORTH	W900	Cummins ISC Diesel	2003 - 2004
PETERBILT	330	Cummins ISC Diesel	1999 - 2005
STERLING	ACTERRA	Cummins ISC Diesel	2005 - 2008
FREIGHTLINER	FL60	Cummins B Series 5.9 L Diesel	1997 - 1997
PETERBILT	335	Cummins ISC Diesel	2005 - 2006
THOMAS BUILT	SAF-T-LINER MVP EF	Cummins ISB Diesel	2000 - 2002
FREIGHTLINER	FL50	Cummins ISC Diesel	1999 - 2005
BLUEBIRD	ALL AMERICAN RE	Cummins ISB Diesel	1999 - 1999
BLUEBIRD	ALL AMERICAN RE	Cummins ISC Diesel	2001 - 2003
BLUEBIRD	CONVENTIONAL	Cummins ISB Diesel	2001 - 2001
THOMAS BUILT	CONVENTIONAL	Cummins ISB Diesel	2000 - 2003
THOMAS BUILT	SAF-T-LINER MVP ER	Cummins ISB Diesel	1999 - 2000
THOMAS BUILT	SAF-T-LINER MVP ER	Cummins ISC Diesel	2000 - 2000
DINA	102 F	CUMMINS ISB	2008 - 2008
DINA	104-R	CUMMINS ISB	2008 - 2008
DINA	104-SF	CUMMINS ISB	2008 - 2008
DINA	94 F	CUMMINS ISB	2008 - 2008
FORD	F650 SUPER DUTY	Cummins ISB Diesel	2001 - 2001
FREIGHTLINER	FL50	Cummins ISB Diesel	1998 - 1999
FORD	F650 SUPER DUTY	Cummins ISB Diesel	2000 - 2000
FREIGHTLINER	FL50	Cummins ISB Diesel	2002 - 2003

FREIGHTLINER	FL50	Cummins ISB Diesel	2000 - 2001
FREIGHTLINER	FL50	Cummins B Series 5.9 L Diesel	1997 - 1997
BLUEBIRD	TC2000	Cummins ISB Diesel	1998 - 2000
FREIGHTLINER	BUSINESS CLASS M2	Cummins ISC Diesel	2004 - 2004
FREIGHTLINER	BUSINESS CLASS M2	Cummins ISC Diesel	2006 - 2006
FORD	F750 SUPER DUTY	Cummins ISB Diesel	2002 - 2004
FORD	F750 SUPER DUTY	Cummins ISB Diesel	2000 - 2000
FREIGHTLINER	FL80	Cummins ISB Diesel	2000 - 2001
FORD	F750 SUPER DUTY	Cummins ISB Diesel	2001 - 2001
FORD	F650 SUPER DUTY	Cummins ISB Diesel	2002 - 2004

**38517**



FORD	F650 SUPER DUTY	Cummins ISB Diesel	2005 - 2007
FREIGHTLINER	FC80	Cummins ISB Diesel	2003 - 2003
FREIGHTLINER	FC70	Cummins ISB Diesel	2003 - 2003
KENWORTH	T300	Cummins ISB Diesel	2005 - 2005
FORD	F750 SUPER DUTY	Cummins ISB Diesel	2005 - 2007
FORD	F600	Cummins B Series 5.9 L Diesel	1992 - 1994
FORD	F800	CUMMINS ISB DIESEL	1998 - 1998

**38519**



INTERNATIONAL/NAVISTAR	9600	Detroit Diesel 6-Cyl. 12.7 L Diesel	1995 - 1995
INTERNATIONAL/NAVISTAR	9100	Detroit Diesel Series 60 Diesel	1998 - 1998
INTERNATIONAL/NAVISTAR	9900ix	Detroit Diesel Series 60 Diesel	2000 - 2000
INTERNATIONAL/NAVISTAR	9900ix	Detroit Diesel 6-Cyl. 12.7 L Diesel	2001 - 2001
INTERNATIONAL/NAVISTAR	9900i	Detroit Diesel Series 60 Diesel	2000 - 2000
INTERNATIONAL/NAVISTAR	9900i	Detroit Diesel 6-Cyl. 12.7 L Diesel	2001 - 2001
INTERNATIONAL/NAVISTAR	9900	Detroit Diesel Series 60 Diesel	1999 - 1999
INTERNATIONAL/NAVISTAR	9800	Detroit Diesel Series 60 Diesel	1997 - 1997

INTERNATIONAL/NAVISTAR	9700	Detroit Diesel 6-Cyl. 12.7 L Diesel	1996 - 1996
INTERNATIONAL/NAVISTAR	9700	Detroit Diesel 6-Cyl. 11.1 L Diesel	1996 - 1996
INTERNATIONAL/NAVISTAR	9200	Detroit Diesel 6-Cyl. 11.1 L Diesel	1995 - 1997
INTERNATIONAL/NAVISTAR	9400i	Detroit Diesel Series 60 Diesel	2000 - 2000
INTERNATIONAL/NAVISTAR	9400i	Detroit Diesel 6-Cyl. 12.7 L Diesel	2001 - 2001
INTERNATIONAL/NAVISTAR	9400	Detroit Diesel Series 60 Diesel	1997 - 1999
INTERNATIONAL/NAVISTAR	9400	Detroit Diesel 6-Cyl. 12.7 L Diesel	1995 - 1996
INTERNATIONAL/NAVISTAR	9400	Detroit Diesel 6-Cyl. 11.1 L Diesel	1995 - 1996
INTERNATIONAL/NAVISTAR	9200	Detroit Diesel Series 60 Diesel	1998 - 1998
INTERNATIONAL/NAVISTAR	9200	Detroit Diesel 6-Cyl. 12.7 L Diesel	1995 - 1997
INTERNATIONAL/NAVISTAR	9600	Detroit Diesel 6-Cyl. 11.1 L Diesel	1996 - 1996

FREIGHTLINER	FL112	Cummins ISM Diesel	2000 - 2003
FREIGHTLINER	FLD	Cummins ISM Diesel	2002 - 2003
FREIGHTLINER	FLD	Cummins ISM Diesel	2000 - 2000
INTERNATIONAL/NAVISTAR	5500	CUMMINS ISM DIESEL	2005 - 2005
INTERNATIONAL/NAVISTAR	5500i	Cummins ISM Diesel	2002 - 2004
INTERNATIONAL/NAVISTAR	5600i	Cummins ISM Diesel	2002 - 2004
FREIGHTLINER	FLD	Cummins ISM Diesel	2001 - 2001
FREIGHTLINER	CLASSIC	Cummins ISM Diesel	2001 - 2003
INTERNATIONAL/NAVISTAR	5600	CUMMINS ISM DIESEL	2005 - 2005

**38523**

**38521**



KENWORTH	T600	Cummins ISM Diesel	2004 - 2004
INTERNATIONAL/NAVISTAR	PROSTAR SERIES	Cummins ISX Diesel	2008 - 2008
INTERNATIONAL/NAVISTAR	9400i	Cummins ISM Diesel	2004 - 2005
INTERNATIONAL/NAVISTAR	9200i	Cummins ISM Diesel	2003 - 2004
KENWORTH	T600	Cummins ISM Diesel	2001 - 2002
INTERNATIONAL/NAVISTAR	8600	Cummins ISM Diesel	2003 - 2004
PETERBILT	385	Cummins ISM Diesel	2002 - 2004
INTERNATIONAL/NAVISTAR	9200	CUMMINS ISM DIESEL	2005 - 2005
KENWORTH	T800	Cummins ISM Diesel	1999 - 2004
KENWORTH	W900	Cummins ISM Diesel	2002 - 2004
PETERBILT	320	Cummins ISM Diesel	2007 - 2007
PETERBILT	378	Cummins ISM Diesel	2001 - 2001
PETERBILT	387	Cummins ISM Diesel	2000 - 2000
FREIGHTLINER	CENTURY CLASS	Cummins ISM Diesel	1998 - 2001
INTERNATIONAL/NAVISTAR	7600	Cummins ISM Diesel	2003 - 2004
PETERBILT	357	Cummins ISM Diesel	2001 - 2004
FREIGHTLINER	CLASSIC XL	Cummins ISM Diesel	2002 - 2003
FREIGHTLINER	CLASSIC XL	Cummins ISM Diesel	2001 - 2001
INTERNATIONAL/NAVISTAR	5900i	Cummins ISM Diesel	2001 - 2004
FREIGHTLINER	ARGOSY	Cummins ISM Diesel	2000 - 2000
FREIGHTLINER	COLUMBIA	Cummins ISM Diesel	2001 - 2003
FREIGHTLINER	CONDOR	Cummins ISM Diesel	2001 - 2002

MACK	RD SERIES	Mack 6-Cyl. 12.0 L Diesel	2001 - 2002
MACK	CH SERIES	Mack 6-Cyl. 12.0 L Diesel	2001 - 2002
MACK	CH SERIES	Mack AC Diesel	2003 - 2006
MACK	CHN SERIES	Mack AC Diesel	2006 - 2007
MACK	DM SERIES	Mack 6-Cyl. 12.0 L Diesel	2001 - 2001
MACK	MR SERIES	Mack 6-Cyl. 12.0 L Diesel	2001 - 2002
MACK	RD SERIES	Mack E7 Diesel	2003 - 2003
MACK	CXP SERIES	Mack MP7 Diesel	2006 - 2006
MACK	CV SERIES	Mack AI Diesel	2006 - 2007
MACK	LE SERIES	Mack AI Diesel	2003 - 2005
MACK	CXN SERIES	Mack AC Diesel	2006 - 2007
MACK	CX SERIES	Mack 6-Cyl. 12.0 L Diesel	2001 - 2002
MACK	CV SERIES	Mack AMI Diesel	2003 - 2003
MACK	CV SERIES	Mack AI Diesel	2003 - 2003
MACK	CV SERIES	MACK AI DIESEL	2005 - 2005
MACK	CV SERIES	Mack 6-Cyl. 12.0 L Diesel	2001 - 2002
MACK	CS SERIES	Mack AC Diesel	2003 - 2003
MACK	CL SERIES	Mack 6-Cyl. 12.0 L Diesel	2001 - 2001
MACK	CV SERIES	Mack AMI Diesel	2004 - 2006



**38524**



FREIGHTLINER	FLD	Caterpillar C10 Diesel	2001 - 2004
STERLING	A-LINE	Caterpillar C12 Diesel	2002 - 2004
FREIGHTLINER	CONDOR	Caterpillar C12 Diesel	2001 - 2004
FREIGHTLINER	FLD	Caterpillar C12 Diesel	2001 - 2004
FREIGHTLINER	FL112	Caterpillar C12 Diesel	2001 - 2004
FREIGHTLINER	FL112	Caterpillar C10 Diesel	2001 - 2004
FREIGHTLINER	COLUMBIA	Caterpillar C12 Diesel	2003 - 2004
FREIGHTLINER	COLUMBIA	Caterpillar C10 Diesel	2001 - 2003
FREIGHTLINER	CENTURY CLASS	Caterpillar C12 Diesel	2001 - 2004
STERLING	A-LINE	Caterpillar C10 Diesel	2002 - 2004
FREIGHTLINER	CENTURY CLASS	Caterpillar C10 Diesel	2001 - 2003
FREIGHTLINER	ARGOSY	Caterpillar C12 Diesel	2000 - 2004
FREIGHTLINER	ARGOSY	Caterpillar C10 Diesel	2000 - 2003
FREIGHTLINER	CONDOR	Caterpillar C10 Diesel	2001 - 2004

**38525**



BLUEBIRD	ALL AMERICAN RE	Cummins ISC Diesel	2004 - 2004
PETERBILT	330	Cummins ISB Diesel	2000 - 2000
FREIGHTLINER	FL80	Cummins ISC Diesel	2000 - 2001
FREIGHTLINER	FL70	Cummins ISC Diesel	2000 - 2001
FREIGHTLINER	FL60	Cummins ISC Diesel	2000 - 2001
BLUEBIRD	VISION	Cummins ISB Diesel	2006 - 2006
FREIGHTLINER	FL50	Cummins ISC Diesel	2000 - 2001

**38527**



KENWORTH	T300	Cummins ISC Diesel	2000 - 2000
----------	------	--------------------	-------------

**38529**



INTERNATIONAL/NAVISTAR	9200	Detroit Diesel Series 60 Diesel	1999 - 1999
INTERNATIONAL/NAVISTAR	9200i	Detroit Diesel 6-Cyl. 12.7 L Diesel	2001 - 2001
INTERNATIONAL/NAVISTAR	9200i	Detroit Diesel Series 60 Diesel	2000 - 2000
INTERNATIONAL/NAVISTAR	9100	Detroit Diesel Series 60 Diesel	1999 - 1999
INTERNATIONAL/NAVISTAR	9100i	Detroit Diesel 6-Cyl. 12.7 L Diesel	2001 - 2003
INTERNATIONAL/NAVISTAR	9100i	Detroit Diesel Series 60 Diesel	2000 - 2000

**38531**



VOLVO	7550	7550	2001 - 2006
VOLVO	WG SERIES	Volvo VE D12 Diesel	1998 - 2001
VOLVO	WG SERIES	Volvo VE D12 Diesel	1999 - 1999
VOLVO	9700	9700	2002 - 2006
VOLVO	7550 FL	7550 FL	2005 - 2008

38532



STERLING	L-LINE	Cummins Signature 600 Diesel	2001 - 2001
PETERBILT	379	Cummins Signature 600 Diesel	2000 - 2002
PETERBILT	378	Cummins ISX Diesel	2000 - 2002
MACK	CL SERIES	Cummins Signature 600 Diesel	2001 - 2003
PETERBILT	378	Cummins Signature 600 Diesel	2000 - 2002
KENWORTH	W900	Cummins Signature 600 Diesel	2000 - 2002
PETERBILT	379	Cummins ISX Diesel	1998 - 2002
MACK	CH SERIES	Cummins Signature 600 Diesel	2001 - 2003
PETERBILT	387	Cummins ISX Diesel	2001 - 2002
PETERBILT	387	Cummins Signature 600 Diesel	2001 - 2002
STERLING	L-LINE	CUMMINS SIGNATURE 600	2001 - 2001
VOLVO	VN SERIES	Cummins ISX Diesel	2000 - 2002
VOLVO	VN SERIES	Cummins ISX Diesel	2003 - 2003
KENWORTH	W900	Cummins ISX Diesel	2003 - 2003
INTERNATIONAL/NAVISTAR	9200i	Cummins Signature 600 Diesel	2000 - 2002
STERLING	L-LINE	Cummins ISX Diesel	2001 - 2001
VOLVO	VN SERIES	Cummins Signature 600 Diesel	2003 - 2003
FREIGHTLINER	ARGOSY	Cummins ISX Diesel	1999 - 2003
FREIGHTLINER	CENTURY CLASS	Cummins ISX Diesel	2000 - 2001
FREIGHTLINER	COLUMBIA	Cummins ISX Diesel	2001 - 2001
INTERNATIONAL/NAVISTAR	9900i	Cummins ISX Diesel	2000 - 2002
INTERNATIONAL/NAVISTAR	9100i	Cummins ISX Diesel	2001 - 2003
KENWORTH	W900	Cummins ISX Diesel	1999 - 2002
INTERNATIONAL/NAVISTAR	9400i	Cummins ISX Diesel	2000 - 2002
INTERNATIONAL/NAVISTAR	9900i	Cummins ISX Diesel	2003 - 2003
INTERNATIONAL/NAVISTAR	9900ix	Cummins ISX Diesel	2000 - 2002
INTERNATIONAL/NAVISTAR	9900ix	Cummins ISX Diesel	2003 - 2003
KENWORTH	T2000	Cummins ISX Diesel	1999 - 2003
KENWORTH	T600	Cummins ISX Diesel	2002 - 2003
KENWORTH	T600	Cummins Signature 600 Diesel	2003 - 2003
KENWORTH	T800	Cummins ISX Diesel	1999 - 2003
FREIGHTLINER	FLD	Cummins ISX Diesel	1999 - 2003

38534



INTERNATIONAL/NAVISTAR	5500i	Caterpillar C12 Diesel	2003 - 2004
INTERNATIONAL/NAVISTAR	7600	Caterpillar C10 Diesel	2004 - 2004
INTERNATIONAL/NAVISTAR	7600	Caterpillar C12 Diesel	2004 - 2004
INTERNATIONAL/NAVISTAR	5900i	Caterpillar C12 Diesel	2003 - 2004
INTERNATIONAL/NAVISTAR	5900i	Caterpillar C10 Diesel	2003 - 2003
INTERNATIONAL/NAVISTAR	5600i	Caterpillar C12 Diesel	2003 - 2004
INTERNATIONAL/NAVISTAR	5600i	Caterpillar C10 Diesel	2003 - 2004
FREIGHTLINER	FLD	Caterpillar C12 Diesel	1998 - 2000
FREIGHTLINER	FLD	Caterpillar C10 Diesel	1998 - 2000
FREIGHTLINER	FL112	Caterpillar C12 Diesel	1999 - 2000
FREIGHTLINER	FL112	Caterpillar C10 Diesel	1999 - 2000
FREIGHTLINER	CENTURY CLASS	Caterpillar C10 Diesel	1999 - 2000
INTERNATIONAL/NAVISTAR	5500i	Caterpillar C10 Diesel	2003 - 2004
FREIGHTLINER	CENTURY CLASS	Caterpillar C12 Diesel	1999 - 2000

38535



STERLING	L-LINE	CUMMINS SIGNATURE 600	2001 - 2001
KENWORTH	W900	Cummins ISX Diesel	2003 - 2003
MACK	CL SERIES	Cummins Signature 600 Diesel	2001 - 2003
PETERBILT	378	Cummins ISX Diesel	2000 - 2002
PETERBILT	378	Cummins Signature 600 Diesel	2000 - 2002
PETERBILT	379	Cummins ISX Diesel	1998 - 2002
PETERBILT	379	Cummins Signature 600 Diesel	2000 - 2002
PETERBILT	387	Cummins ISX Diesel	2001 - 2002
KENWORTH	W900	Cummins ISX Diesel	1999 - 2002
STERLING	L-LINE	Cummins ISX Diesel	2001 - 2001
KENWORTH	W900	Cummins Signature 600 Diesel	2000 - 2002

STERLING	L-LINE	Cummins Signature 600 Diesel	2001 - 2001
VOLVO	VN SERIES	Cummins ISX Diesel	2000 - 2002
VOLVO	VN SERIES	Cummins ISX Diesel	2003 - 2003
VOLVO	VN SERIES	Cummins Signature 600 Diesel	2003 - 2003
PETERBILT	387	Cummins Signature 600 Diesel	2001 - 2002
FREIGHTLINER	CENTURY CLASS	Cummins ISX Diesel	2001 - 2001
MACK	CH SERIES	Cummins Signature 600 Diesel	2001 - 2003
FREIGHTLINER	CENTURY CLASS	Cummins ISX Diesel	2000 - 2000
KENWORTH	T800	Cummins ISX Diesel	1999 - 2003
FREIGHTLINER	COLUMBIA	Cummins ISX Diesel	2001 - 2001
FREIGHTLINER	FLD	Cummins ISX Diesel	1999 - 2003
INTERNATIONAL/NAVISTAR	9100i	Cummins ISX Diesel	2001 - 2003
INTERNATIONAL/NAVISTAR	9200i	Cummins Signature 600 Diesel	2000 - 2002
INTERNATIONAL/NAVISTAR	9900i	Cummins ISX Diesel	2000 - 2002
INTERNATIONAL/NAVISTAR	9900i	Cummins ISX Diesel	2003 - 2003
INTERNATIONAL/NAVISTAR	9900ix	Cummins ISX Diesel	2000 - 2002
INTERNATIONAL/NAVISTAR	9900ix	Cummins ISX Diesel	2003 - 2003
KENWORTH	T2000	Cummins ISX Diesel	1999 - 2003
KENWORTH	T600	Cummins ISX Diesel	2002 - 2003
KENWORTH	T600	Cummins Signature 600 Diesel	2003 - 2003
FREIGHTLINER	ARGOSY	Cummins ISX Diesel	1999 - 2003
INTERNATIONAL/NAVISTAR	9400i	Cummins ISX Diesel	2000 - 2002

**38536**



VOLVO	VN SERIES	Cummins N14 Diesel	2000 - 2002
VOLVO	VNL	CUMMINS N14	2002 - 2003
VOLVO	VNM	CUMMINS N14	2002 - 2003

**38539**



VOLVO	VHD	Cummins ISM Diesel	2002 - 2003
VOLVO	VN SERIES	Cummins ISM Diesel	2002 - 2003

**38540**



FREIGHTLINER	CENTURY CLASS	Mercedes-Benz MBE 4000 Diesel	2004 - 2004
FREIGHTLINER	COLUMBIA	Mercedes-Benz MBE 4000 Diesel	2003 - 2004
FREIGHTLINER	FL112	Mercedes-Benz MBE 4000 Diesel	2003 - 2004

**38541**



FREIGHTLINER	CENTURY CLASS	Mercedes-Benz MBE 4000 Diesel	2004 - 2004
FREIGHTLINER	COLUMBIA	Mercedes-Benz MBE 4000 Diesel	2003 - 2004
FREIGHTLINER	FL112	Mercedes-Benz MBE 4000 Diesel	2003 - 2004

**38545**



VOLVO	VN SERIES	Cummins ISM Diesel	2001 - 2001
-------	-----------	--------------------	-------------

**38547**



VOLVO	VHD	Volvo VE D12 Diesel	2001 - 2002
-------	-----	---------------------	-------------

**38556**



INTERNATIONAL/NAVISTAR	4300	International/Navistar VT365 Diesel	2003 - 2003
FORD	F750 SUPER DUTY	Ford V-8 6.0 L Diesel	2003 - 2006
INTERNATIONAL/NAVISTAR	DURASTAR 4300	International/Navistar MaxxForce DT Diesel	2008 - 2008
INTERNATIONAL/NAVISTAR	4400	International/Navistar VT365 Diesel	2003 - 2003
INTERNATIONAL/NAVISTAR	4200	International/Navistar VT365 Diesel	2002 - 2007
INTERNATIONAL/NAVISTAR	4100	International/Navistar VT365 Diesel	2006 - 2007
INTERNATIONAL/NAVISTAR	CE	International/Navistar VT365 Diesel	2007 - 2007
INTERNATIONAL/NAVISTAR	CE	International/Navistar VT365 Diesel	2007 - 2007
INTERNATIONAL/NAVISTAR	BE	International/Navistar MaxxForce 7 Diesel	2008 - 2008
INTERNATIONAL/NAVISTAR	CE	International/Navistar VT365 Diesel	2005 - 2005
INTERNATIONAL/NAVISTAR	BE	International/Navistar VT365 Diesel	2007 - 2008
INTERNATIONAL/NAVISTAR	DURASTAR 4300	International/Navistar MaxxForce 7 Diesel	2008 - 2008
FORD	F650 SUPER DUTY	Ford V-8 6.0 L Diesel	2003 - 2006

**38548**



CHEVROLET	C7500	Isuzu 6HK1-TC Diesel	2003 - 2006
CHEVROLET	C8500	Isuzu 6HK1-TC Diesel	2003 - 2006
CHEVROLET	C6500	Isuzu 6HK1-TC Diesel	2003 - 2006

**38550**



FORD	F750 SUPER DUTY	Caterpillar C7 Diesel	2004 - 2006
STERLING	L-LINE	Caterpillar C7 Diesel	2005 - 2005
STERLING	L-LINE	CATERPILLAR C7 DIESEL	2005 - 2005
FREIGHTLINER	BUSINESS CLASS M2	Caterpillar C9 Diesel	2004 - 2007
FREIGHTLINER	BUSINESS CLASS M2	Caterpillar 3126 Diesel	2002 - 2007
FORD	F650 SUPER DUTY	Caterpillar C7 Diesel	2004 - 2006
THOMAS BUILT	SAF-T-LINER MVP ER	Caterpillar C7 Diesel	2004 - 2005
THOMAS BUILT	SAF-T-LINER MVP EF	Caterpillar C7 Diesel	2005 - 2006
THOMAS BUILT	SAF-T-LINER C2	Caterpillar C7 Diesel	2008 - 2008
BLUEBIRD	VISION	Caterpillar C7 Diesel	2006 - 2007
FREIGHTLINER	BUSINESS CLASS M2	Caterpillar C7 Diesel	2004 - 2007

**38557**



CHEVROLET	C6500	Caterpillar 3126 Diesel	2003 - 2003
CHEVROLET	C7500	Caterpillar 3126 Diesel	2003 - 2003
CHEVROLET	C8500	Caterpillar 3126 Diesel	2003 - 2003

**38567**



FREIGHTLINER	BUSINESS CLASS M2	Mercedes-Benz MBE 900 Diesel	2006 - 2008
--------------	-------------------	------------------------------	-------------

STERLING	ACTERRA	Mercedes-Benz MBE 900 Diesel	2001 - 2007
STERLING	ACTERRA	MERCEDES-BENZ MBE 900 DIESEL	2004 - 2004
THOMAS BUILT	SAF-T-LINER C2	Mercedes-Benz MBE 900 Diesel	2008 - 2008
THOMAS BUILT	SAF-T-LINER C2	Mercedes-Benz MBE 900 Diesel	2009 - 2009
THOMAS BUILT	CONVENTIONAL	Mercedes-Benz MBE 900 Diesel	2006 - 2006
FREIGHTLINER	BUSINESS CLASS M2	Mercedes-Benz MBE 900 Diesel	2004 - 2005
STERLING	ACTERRA	MERCEDES-BENZ MBE 900 DIESEL	2003 - 2002

**38569**



PETERBILT	379	Caterpillar C15 Diesel	2004 - 2004
KENWORTH	W900	Caterpillar C15 Diesel	2004 - 2005
KENWORTH	W900	Caterpillar C15 Diesel	2006 - 2007
PETERBILT	357	Caterpillar C15 Diesel	2004 - 2005
PETERBILT	357	Caterpillar C15 Diesel	2006 - 2006
PETERBILT	378	Caterpillar C15 Diesel	2005 - 2005
PETERBILT	378	Caterpillar C15 Diesel	2006 - 2006
PETERBILT	379	Caterpillar C15 Diesel	2005 - 2007
PETERBILT	387	Caterpillar C15 Diesel	2004 - 2007
KENWORTH	T600	Caterpillar C15 Diesel	2007 - 2007
KENWORTH	T800	Caterpillar C15 Diesel	2005 - 2005
PETERBILT	378	Caterpillar C15 Diesel	2003 - 2004
FREIGHTLINER	COLUMBIA	Caterpillar C15 Diesel	2005 - 2005
KENWORTH	T800	Caterpillar C15 Diesel	2006 - 2007
FREIGHTLINER	CLASSIC XL	Caterpillar C15 Diesel	2005 - 2005
FREIGHTLINER	CORONADO	Caterpillar C15 Diesel	2005 - 2006
FREIGHTLINER	FLD	Caterpillar C15 Diesel	2005 - 2008
INTERNATIONAL/NAVISTAR	5600i	Caterpillar C15 Diesel	2004 - 2004
INTERNATIONAL/NAVISTAR	5900i	Caterpillar C15 Diesel	2004 - 2006
INTERNATIONAL/NAVISTAR	9900i	Caterpillar C15 Diesel	2004 - 2007
INTERNATIONAL/NAVISTAR	9900ix	Caterpillar C15 Diesel	2004 - 2007
INTERNATIONAL/NAVISTAR	PAYSTAR 5600i	Caterpillar C15 Diesel	2008 - 2008
KENWORTH	T2000	Caterpillar C15 Diesel	2004 - 2007
FREIGHTLINER	CENTURY CLASS	Caterpillar C15 Diesel	2005 - 2006
INTERNATIONAL/NAVISTAR	9400i	Caterpillar C15 Diesel	2004 - 2007

**38579**



CHEVROLET	T8500	Isuzu 6HK1-TC Diesel	2005 - 2008
CHEVROLET	T7500	Isuzu 6HK1-TC Diesel	2005 - 2008
CHEVROLET	T6500	Isuzu 6HK1-TC Diesel	2005 - 2008

**38581**



VOLVO	VT SERIES	Volvo VE D16 Diesel	2006 - 2008
VOLVO	VN SERIES	Volvo VE D16 Diesel	2006 - 2008
VOLVO	VN SERIES	Volvo VE D12 Diesel	2004 - 2008
VOLVO	VN SERIES	Volvo D16 Diesel	2008 - 2008
VOLVO	VHD	Volvo VE 12 Diesel	2002 - 2002
VOLVO	VHD	Volvo VE D12 Diesel	2003 - 2008

**38584**



VOLKSWAGEN	24-250 WORKER	Cummins Interact 5.9 DIESEL (EURO III)	2005 - 2008
VOLKSWAGEN	8-150 VOLKSBUS	Cummins Interact 3.9 DIESEL (EURO III)	2005 - 2008
VOLKSWAGEN	8-150 WORKER	Cummins Interact 3.9 DIESEL (EURO III)	2005 - 2008
VOLKSWAGEN	17-210 VOLKSBUS	MWM de 6.2 DIESEL ELECTRONICO	2005 - 2008
VOLKSWAGEN	15-190 WORKER	Cummins Interact 5.9 DIESEL (EURO III)	2005 - 2008
VOLKSWAGEN	17-250 WORKER	Cummins Interact 5.9 DIESEL (EURO III)	2005 - 2008

**38585**



VOLVO	VHD	Volvo VE D12 Diesel	2005 - 2008
VOLVO	VN SERIES	Volvo D16 Diesel	2008 - 2008
VOLVO	VN SERIES	Volvo VE D12 Diesel	2004 - 2008
VOLVO	VN SERIES	Volvo VE D16 Diesel	2006 - 2008
VOLVO	VT SERIES	Volvo VE D16 Diesel	2006 - 2008

**38586**



PETERBILT	335	Caterpillar C7 Diesel	2005 - 2007
STERLING	L-LINE	Caterpillar C7 Diesel	2007 - 2007
PETERBILT	330	Caterpillar C7 Diesel	2004 - 2007
CHEVROLET	C8500	Caterpillar C7 Diesel	2004 - 2007
CHEVROLET	C7500	Caterpillar C7 Diesel	2004 - 2007
CHEVROLET	C6500	Caterpillar C7 Diesel	2004 - 2007
KENWORTH	T300	Caterpillar C7 Diesel	2004 - 2007

**38587**



KENWORTH	T800	Cummins ISX Diesel	2004 - 2008
KENWORTH	W900	Cummins ISX Diesel	2004 - 2007
KENWORTH	W900	Cummins ISX Diesel	2003 - 2003
MACK	CL SERIES	Cummins ISX Diesel	2004 - 2007
PETERBILT	357	Cummins ISX Diesel	2006 - 2006

PETERBILT	367	Cummins ISX Diesel	2007 - 2008
PETERBILT	378	Cummins ISX Diesel	2004 - 2007
VOLVO	VN SERIES	Cummins Signature 600 Diesel	2003 - 2003
PETERBILT	386	Cummins ISX Diesel	2008 - 2008
PETERBILT	389	Cummins ISX Diesel	2008 - 2008
VOLVO	VN SERIES	Cummins ISX Diesel	2004 - 2007
VOLVO	VN SERIES	Cummins ISX Diesel	2003 - 2003
PETERBILT	379	Cummins ISX Diesel	2003 - 2007
VOLVO	VT SERIES	Cummins ISX Diesel	2006 - 2006
INTERNATIONAL/NAVISTAR	9400i	Cummins ISX Diesel	2003 - 2007
PETERBILT	387	Cummins ISX Diesel	2004 - 2006
KENWORTH	T660	Cummins ISX Diesel	2007 - 2008
INTERNATIONAL/NAVISTAR	5500i	Cummins ISX Diesel	2003 - 2007
INTERNATIONAL/NAVISTAR	5600i	Cummins ISX Diesel	2005 - 2007
INTERNATIONAL/NAVISTAR	9200i	Cummins ISX Diesel	2003 - 2007
INTERNATIONAL/NAVISTAR	9900i	Cummins ISX Diesel	2004 - 2007
INTERNATIONAL/NAVISTAR	9900i	Cummins ISX Diesel	2003 - 2003
INTERNATIONAL/NAVISTAR	9900ix	Cummins ISX Diesel	2004 - 2007
INTERNATIONAL/NAVISTAR	9900ix	Cummins ISX Diesel	2003 - 2003
INTERNATIONAL/NAVISTAR	PAYSTAR 5500i	Cummins ISX Diesel	2008 - 2008
INTERNATIONAL/NAVISTAR	PAYSTAR 5900i	Cummins ISX Diesel	2008 - 2008
KENWORTH	T2000	Cummins ISX Diesel	2004 - 2006
KENWORTH	T600	Cummins ISX Diesel	2004 - 2007
INTERNATIONAL/NAVISTAR	5900i	Cummins ISX Diesel	2003 - 2007

**38589**



MACK	CXN SERIES	Mack AC Diesel	2006 - 2007
MACK	CX SERIES	Mack AC Diesel	2003 - 2006
MACK	MR SERIES	Mack AMI Diesel	2003 - 2005
MACK	CHN SERIES	Mack AC Diesel	2006 - 2007
MACK	CXP SERIES	Mack MP7 Diesel	2006 - 2006
MACK	CV SERIES	Mack AI Diesel	2006 - 2007
MACK	CT SERIES	Mack AMI Diesel	2006 - 2006
MACK	CT SERIES	Mack AI Diesel	2006 - 2006
MACK	CT SERIES	Mack AI Diesel	2007 - 2007

MACK	CV SERIES	Mack AMI Diesel	2004 - 2005
MACK	CH SERIES	Mack AC Diesel	2003 - 2006

**38590**



INTERNATIONAL/NAVISTAR	7600	Caterpillar C13 Diesel	2004 - 2008
INTERNATIONAL/NAVISTAR	7700	Caterpillar C11 Diesel	2005 - 2006
INTERNATIONAL/NAVISTAR	7700	Caterpillar C13 Diesel	2005 - 2006
INTERNATIONAL/NAVISTAR	8600	Caterpillar C11 Diesel	2004 - 2007
INTERNATIONAL/NAVISTAR	8600	Caterpillar C13 Diesel	2004 - 2007
STERLING	A-LINE	Caterpillar C15 Diesel	2005 - 2006
INTERNATIONAL/NAVISTAR	9200i	Caterpillar C13 Diesel	2004 - 2006
INTERNATIONAL/NAVISTAR	9400i	Caterpillar C13 Diesel	2004 - 2007
INTERNATIONAL/NAVISTAR	5500i	Caterpillar C13 Diesel	2005 - 2007

STERLING	L-LINE	Caterpillar C9 Diesel	2005 - 2007
KENWORTH	W900	Caterpillar C11 Diesel	2005 - 2007
KENWORTH	W900	Caterpillar C13 Diesel	2004 - 2007
PETERBILT	357	Caterpillar C11 Diesel	2006 - 2007
PETERBILT	357	Caterpillar C13 Diesel	2005 - 2007
PETERBILT	378	Caterpillar C13 Diesel	2005 - 2005
PETERBILT	379	Caterpillar C11 Diesel	2005 - 2006
PETERBILT	379	Caterpillar C13 Diesel	2004 - 2006
PETERBILT	385	Caterpillar C13 Diesel	2005 - 2006
PETERBILT	386	Caterpillar C13 Diesel	2007 - 2007
PETERBILT	387	Caterpillar C13 Diesel	2004 - 2005
STERLING	ACTERRA	Caterpillar C13 Diesel	2006 - 2006
STERLING	A-LINE	Caterpillar C13 Diesel	2005 - 2006
STERLING	L-LINE	Caterpillar C11 Diesel	2004 - 2007
STERLING	L-LINE	Caterpillar C13 Diesel	2004 - 2007
STERLING	L-LINE	Caterpillar C15 Diesel	2005 - 2007
KENWORTH	T800	Caterpillar C13 Diesel	2004 - 2007
STERLING	A-LINE	Caterpillar C11 Diesel	2004 - 2006
STERLING	ACTERRA	Caterpillar C13 Diesel	2006 - 2006
FREIGHTLINER	CENTURY CLASS	Caterpillar C11 Diesel	2006 - 2006
KENWORTH	T800	Caterpillar C11 Diesel	2003 - 2008
FREIGHTLINER	BUSINESS CLASS M2	Caterpillar C13 Diesel	2004 - 2007
FREIGHTLINER	CENTURY CLASS	Caterpillar C13 Diesel	2006 - 2006
FREIGHTLINER	COLUMBIA	Caterpillar C11 Diesel	2004 - 2007
FREIGHTLINER	COLUMBIA	Caterpillar C13 Diesel	2004 - 2008
FREIGHTLINER	CONDOR	Caterpillar C11 Diesel	2005 - 2005
FREIGHTLINER	CONDOR	Caterpillar C13 Diesel	2005 - 2005
FREIGHTLINER	FLD	Caterpillar C11 Diesel	2005 - 2007
FREIGHTLINER	FLD	Caterpillar C13 Diesel	2005 - 2007
INTERNATIONAL/NAVISTAR	5600i	Caterpillar C13 Diesel	2005 - 2005
INTERNATIONAL/NAVISTAR	7600	Caterpillar C11 Diesel	2004 - 2007

**38597**



FREIGHTLINER	COLUMBIA	Mercedes-Benz MBE 4000 Diesel	2005 - 2007
STERLING	A-LINE	Mercedes-Benz MBE 4000 Diesel	2004 - 2008
FREIGHTLINER	CENTURY CLASS	Mercedes-Benz MBE 4000 Diesel	2005 - 2005
FREIGHTLINER	BUSINESS CLASS M2	Mercedes-Benz MBE 4000 Diesel	2004 - 2007
STERLING	L-LINE	Mercedes-Benz MBE 4000 Diesel	2003 - 2007

**38598**

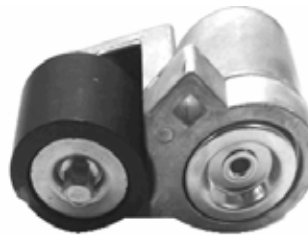

FREIGHTLINER	BUSINESS CLASS M2	Mercedes-Benz MBE 900 Diesel	2006 - 2007
--------------	-------------------	------------------------------	-------------

**38599**



MACK	LE SERIES	Mack AI Diesel	2004 - 2004
MACK	LE SERIES	Mack AI Diesel	2005 - 2006

MACK	MR SERIES	Mack AI Diesel	2005 - 2006
MACK	MR SERIES	Mack AMI Diesel	2003 - 2005
MACK	MR SERIES	Mack AMI Diesel	2007 - 2007
MACK	MR SERIES	Mack AMI Diesel	2006 - 2006

**38607**



VOLVO	VN SERIES	Cummins ISM Diesel	2002 - 2003
MACK	CTP SERIES	Mack MP7 Diesel	2007 - 2007
MACK	CXP SERIES	Mack MP7 Diesel	2007 - 2007
VOLVO	9700 FL	9700 FL	2005 - 2008
VOLVO	VHD	Cummins ISM Diesel	2002 - 2003

**38611**



MACK	CX SERIES	Mack AC Diesel	2003 - 2005
------	-----------	----------------	-------------

**38617**



MACK	CX SERIES	Mack AC Diesel	2006 - 2006
------	-----------	----------------	-------------

**38620**



INTERNATIONAL/NAVISTAR	8600	International/Navistar HT570 Diesel	2005 - 2005
INTERNATIONAL/NAVISTAR	CXT	International/Navistar DT466 Diesel	2005 - 2006
INTERNATIONAL/NAVISTAR	8500	International/Navistar HT570 Diesel	2005 - 2007
INTERNATIONAL/NAVISTAR	8500	International/Navistar DT570 Diesel	2006 - 2006
INTERNATIONAL/NAVISTAR	7500	International/Navistar HT570 Diesel	2005 - 2007
INTERNATIONAL/NAVISTAR	7400	International/Navistar DT570 Diesel	2005 - 2007
INTERNATIONAL/NAVISTAR	7400	International/Navistar DT466 Diesel	2005 - 2007
INTERNATIONAL/NAVISTAR	7400	International/Navistar 570 Diesel	2006 - 2006
INTERNATIONAL/NAVISTAR	7300	International/Navistar DT466 Diesel	2005 - 2006
INTERNATIONAL/NAVISTAR	CE	International/Navistar DT466 Diesel	2008 - 2008
INTERNATIONAL/NAVISTAR	4400	International/Navistar DT466 Diesel	2006 - 2008
INTERNATIONAL/NAVISTAR	4300	International/Navistar DT466 Diesel	2005 - 2008
INTERNATIONAL/NAVISTAR	RE	International/Navistar DT466 Diesel	2007 - 2007
INTERNATIONAL/NAVISTAR	RE	International/Navistar DT466 Diesel	1998 - 2006
INTERNATIONAL/NAVISTAR	FE	International/Navistar DT466 Diesel	2005 - 2005
INTERNATIONAL/NAVISTAR	CE	International/Navistar MaxxForce DT Diesel	2008 - 2008
INTERNATIONAL/NAVISTAR	CE	International/Navistar DT466 Diesel	2005 - 2007
INTERNATIONAL/NAVISTAR	RXT	International/Navistar DT570 Diesel	2006 - 2006
INTERNATIONAL/NAVISTAR	4400	International/Navistar DT570 Diesel	2004 - 2008

**38622**



INTERNATIONAL/NAVISTAR	WORKSTAR 7600	Cummins ISM Diesel	2008 - 2008
KENWORTH	T800	Cummins ISM Diesel	2005 - 2006
KENWORTH	W900	Cummins ISM Diesel	2005 - 2006
PETERBILT	357	Cummins ISM Diesel	2005 - 2007
INTERNATIONAL/NAVISTAR	TRANSTAR 8600	Cummins ISM Diesel	2008 - 2008
PETERBILT	378	Cummins ISM Diesel	2004 - 2007



INTERNATIONAL/NAVISTAR	5900i	Cummins ISM Diesel	2005 - 2006
PETERBILT	365	Cummins ISM Diesel	2007 - 2007
INTERNATIONAL/NAVISTAR	9400i	Cummins ISM Diesel	2006 - 2007
INTERNATIONAL/NAVISTAR	9200i	Cummins ISM Diesel	2005 - 2007
INTERNATIONAL/NAVISTAR	8600	Cummins ISM Diesel	2005 - 2007
INTERNATIONAL/NAVISTAR	7700	Cummins ISM Diesel	2005 - 2006
INTERNATIONAL/NAVISTAR	7400	Cummins ISM Diesel	2005 - 2005
INTERNATIONAL/NAVISTAR	5600i	Cummins ISM Diesel	2005 - 2007
INTERNATIONAL/NAVISTAR	5500i	Cummins ISM Diesel	2005 - 2006
PETERBILT	385	Cummins ISM Diesel	2005 - 2005
INTERNATIONAL/NAVISTAR	7600	Cummins ISM Diesel	2005 - 2007

## Tensores automáticos DRIVEALIGN® para servicio pesado.

Diseñados para bandas Micro-V que accionan a los componentes asociados al motor como son el alternador, Bomba de agua, Dirección Hidráulica, etc. Los motores a diesel castigan duramente a los tensores automáticos, hasta llevarlos a una rotura prematura. Esto no pasa en los tensores DriveAlign® de Gates. Están diseñados para superar las severas exigencias del equipo original, con las siguientes características:

1. Sello laberinto - evita la contaminación de las piezas internas para asegurar una máxima durabilidad.

2. La polea de acero reduce el desgaste de la superficie y además protege los rodamientos internos de contaminantes del exterior.

3. Los rodamientos en fila doble minimizan la fricción, lo que reduce el desgaste de los rodamientos y el ruido.

4. Componentes optimizados, diseñados para garantizar una potencia y durabilidad máximas.

5. El diseño patentado ofrece una alineación y tensión superiores de la banda para obtener un óptimo rendimiento y una máxima duración.

6. El resorte de torsión de cromo-silicona ofrece más resistencia a la flexión.

7. El mecanismo patentado de amortiguación ofrece una máxima estabilidad, reduciendo las vibraciones y prolongando la vida del tensor.

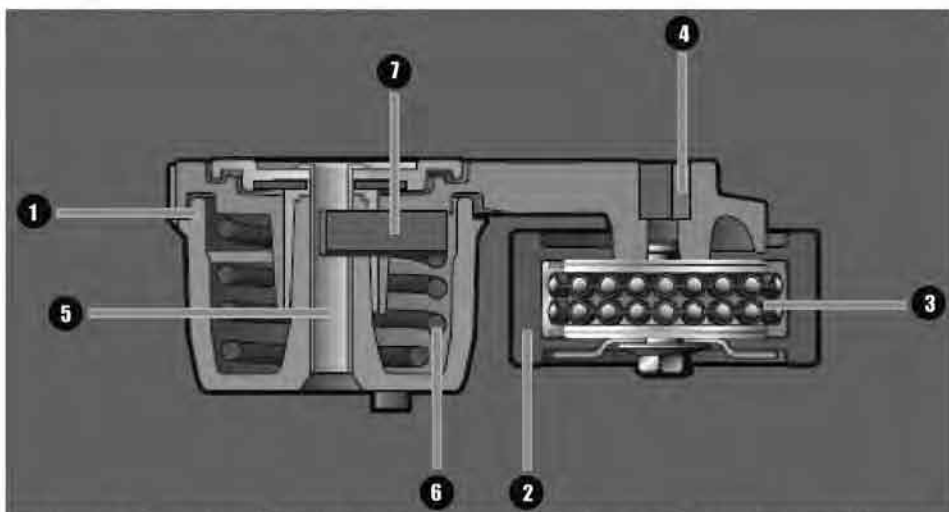

Los tensores DriveAlign® Gates para aplicaciones de Servicio Pesado se caracterizan por una duración tres veces superior a la de los tensores de la competencia.

ES MEJOR EN

# PAQUETE

• Banda Micro V • Polea • Tensor



## Tablas de Equivalencias

Intercambio	Gates
231014	30024
231015	30008
231016	30023
231018	30007
231026	30026
231027	30020
231028	30034
231029	30030
231033	30018
231034	30040
231035	30003
231036	30037
231037	30032
231038	30031
231039	30036
231043	30047
231044	30048
231048	30022
231051	30100
231056	30103
231070	30082
231076	30038
231080	30012
231081	30001
231082	30019
231083	30017
231084	30006
231085	30006
231086	30009
231097	30042
231098	30043
231107	30006
231108	30016
231110	30027
231111	30002
231114	30084
231115	30091
231120	30092
231121	30090
231360	30216
305201	30108
305201	30001
305202	30143
305202	30001
305203	30105
305203	30007
305203	30001
305204	30144
305204	30001
305205	30142
305205	30001
305206	30141
305206	30019

Intercambio	Gates
305207	30125
305207	30005
305208	30117
305208	30006
305209	30122
305209	30001
305210	30183
305210	30006
305211	30130
305211	30001
305213	30118
305213	30006
305214	30113
305214	30001
305215	30116
305215	30016
305216	30124
305216	30001
305217	30139
305217	30009
305218	30132
305218	30006
305219	30157
305220	30121
305220	30006
305221	30140
305221	30012
305222	30131
305222	30022
305223	30184
305223	30001
305224	30115
305224	30001
305225	30107
305225	30001
305226	30109
305226	30026
305227	30106
305227	30009
305228	30135
305228	30017
305229	30110
305229	30026
305230	30102
305230	30008
305231	30103
305231	30008
305232	30145
305232	30001
305233	30114
305233	30006
305234	30146
305234	30011

Intercambio	Gates
305235	30180
305235	30098
305236	30123
305236	30006
305237	30133
305237	30023
305238	30134
305238	30002
305239	30101
305239	30002
305241	30104
305241	30009
305242	30111
305242	30002
305243	30120
305243	30027
305244	30168
305244	30032
305245	30163
305245	30018
305246	30119
305246	30022
305247	30127
305247	30009
305248	30129
305248	30001
305249	30126
305249	30027
305250	30128
305250	30027
305251	30113
305251	30001
305252	30137
305252	30008
305253	30198
305253	30009
305254	30167
305254	30001
305254	30009
305255	30173
305255	30119
305256	30169
305256	30001
305258	30159
305258	30169
305259	30166
305260	30138
305260	30007
305264	30164
305264	30015
305265	30165
305265	30015
305280	30185

Intercambio	Gates
305280	30018
305281	30186
305281	30006
305283	30147
305284	30148
305284	30018
305285	30151
305285	30141
305286	30179
305286	30009
305291	30189
305291	30006
305295	30181
305295	30006
305296	30182
305296	30006
305303	30170
305304	30149
305304	30027
305319	30176
305319	30156
305321	30278
305322	30284
305325	30182
305328	30322
305331	30154
305331	30152
305333	30223
305334	30264
305335	30174
305336	30193
305336	30141
305342	30201
305343	30224
305344	30263
305345	30184
305346	30175
305347	30192
305347	30152
305348	30217
305349	30218
305350	30219
305351	30220
305352	30221
305353	30222
305354	30225
305356	30286
305356	30018
305362	30285
89001	30012
89002	30017
89003	30006
89004	30019

Intercambio	Gates
89005	30023
89006	30001
89007	30006
89008	30016
89009	30009
89010	30027
89011	30002
89012	30019
89013	30029
89014	30024
89015	30008
89016	30028
89017	30015
89018	30007
89020	30038
89025	30039
89026	30026
89027	30020
89028	30034
89029	30030
89031	30050
89032	30051
89033	30018
89034	30040
89035	30003
89036	30037
89037	30032
89038	30031
89039	30036
89040	30039
89042	30045
89043	30047
89044	30048
89045	30046
89046	30071
89047	30049
89048	30022
89049	30044
89050	30099
89051	30100
89052	30101
89053	30053
89054	30102
89055	30002
89056	30103
89057	30052
89058	30018
89059	30006
89070	30082
89071	30087
89072	30068
89073	30088
89074	30079

## Tablas de Equivalencias

Intercambio	Gates
89075	30093
89076	30078
89077	30066
89078	30064
89079	30084
89080	30091
89081	30074
89082	30081
89083	30083
89086	30090
89087	30077
89088	30070
89089	30069
89090	30080
89101	30091
89102	30092
89103	30093
89104	30094
89105	30095
89106	30096
89107	30097
89108	30098
89201	30108
89201	30001
89202	30143
89202	30001
89203	30105
89203	30007
89203	30001
89204	30144
89204	30001
89205	30142
89205	30001
89206	30141
89206	30019
89207	30125
89207	30005
89208	30117
89208	30006
89209	30122
89209	30001
89210	30103
89210	30006
89211	30130
89211	30001
89212	30112
89212	30010
89213	30118
89213	30006
89214	30113
89214	30001
89215	30116
89215	30016

Intercambio	Gates
89216	30124
89216	30001
89217	30139
89217	30009
89218	30132
89218	30006
89219	30157
89220	30121
89220	30006
89221	30140
89221	30012
89222	30131
89222	30022
89223	30104
89223	30001
89224	30115
89224	30001
89225	30107
89225	30001
89226	30109
89226	30026
89227	30106
89227	30009
89228	30135
89228	30017
89229	30110
89229	30026
89230	30102
89230	30008
89231	30103
89231	30008
89232	30145
89232	30001
89233	30114
89233	30006
89234	30146
89234	30011
89235	30180
89235	30058
89236	30123
89236	30006
89237	30133
89237	30023
89238	30134
89238	30002
89239	30101
89239	30002
89240	30112
89240	30010
89241	30104
89241	30009
89242	30111
89242	30002

Intercambio	Gates
89243	30120
89243	30027
89244	30168
89244	30032
89245	30163
89245	30018
89246	30119
89246	30022
89247	30127
89247	30009
89248	30129
89248	30001
89249	30126
89249	30027
89250	30128
89250	30027
89251	30113
89251	30001
89252	30137
89252	30008
89253	30158
89253	30009
89254	30167
89254	30001
89254	30009
89255	30173
89255	30119
89256	30169
89256	30001
89257	30191
89257	30028
89257	30053
89258	30159
89258	30169
89259	30166
89260	30138
89260	30007
89261	30155
89261	30018
89262	30150
89262	30008
89263	30274
89264	30164
89264	30015
89265	30165
89265	30015
89266	30153
89266	30006
89267	30156
89267	30010
89268	30136
89268	30006
89269	30178

Intercambio	Gates
89269	30101
89280	30185
89280	30018
89281	30186
89281	30006
89283	30147
89284	30148
89284	30018
89285	30151
89285	30141
89286	30179
89286	30009
89287	30245
89288	30152
89288	30015
89289	30246
89290	30247
89290	30032
89291	30189
89291	30006
89292	30288
89293	30248
89293	30019
89294	30249
89295	30181
89295	30006
89296	30182
89296	30006
89297	30250
89298	30015
89299	30253
89299	30009
89300	30254
89300	30015
89301	30289
89301	30006
89302	30271
89302	30006
89303	30170
89304	30149
89304	30027
89305	30291
89306	30161
89306	30002
89307	30160
89308	30162
89308	30006
89309	30251
89310	30187
89310	30001
89311	30266
89311	30005
89312	30171

Intercambio	Gates
89312	30001
89313	30257
89314	30308
89316	30177
89316	30011
89317	30197
89317	30025
89318	30188
89318	30008
89319	30176
89319	30156
89322	30284
89323	30260
89323	30009
89324	30259
89325	30302
89326	30267
89328	30322
89330	30275
89331	30154
89331	30152
89333	30223
89334	30264
89335	30174
89336	30193
89336	30141
89337	30194
89337	30008
89338	30195
89338	30008
89339	30196
89340	30198
89340	30027
89341	30199
89341	30141
89342	30201
89343	30224
89344	30263
89345	30304
89346	30175
89347	30192
89347	30152
89348	30217
89349	30218
89350	30219
89351	30220
89352	30221
89353	30222
89354	30225
89355	30226
89356	30286
89356	30018
89360	30216

## Tablas de Equivalencias

Intercambio	Gates
89361	38190
89361	38018
89365	38402
89365	38027
89366	38396
89366	38012
89367	38365
89367	38006
89401	38507
89401	38076
89402	38514
89404	38557
89405	38506
89406	38516
89407	38517
89408	38511
89409	38504
89410	38508
89411	38519
89412	38512
89413	38510
89414	38513
89415	38518
89417	38520
89418	38521
89419	38501
89420	38522
89420	38076
89421	38535
89421	36092
89422	38532
89422	36095
89423	38529
89425	38528
89426	38539
89427	38545
89428	38536
89429	38507
89429	38076
89431	38578
89432	38523
89432	38076
89433	38611
89433	36092
89434	38551
89435	38537
89436	38503
89436	38076
89437	38552
89438	38589
89439	38590
89440	38587
89441	38511

Intercambio	Gates
89441	38076
89442	38505
89442	38076
89444	38550
89445	38586
89446	38620
89447	38569
89448	38610
89449	38523
89449	38076
89456	38581
89457	38585
89459	38547
49001	38001
49001	38001
49002	38002
49002	38002
49003	38009
49003	38009
49004	38016
49004	38016
49005	38005
49005	38005
49006	38006
49006	38006
49007	38007
49007	38007
49008	38022
49008	38022
49009	38025
49009	38025
49010	38032
49010	38032
49011	38015
49011	38015
49012	38003
49012	38003
49013	38020
49013	38020
49014	38010
49014	38010
49015	38012
49015	38012
49016	38019
49016	38019
49017	38023
49017	38023
49018	38024
49018	38024
49019	38027
49019	38027
49020	38004
49020	38004

Intercambio	Gates
49021	38008
49021	38008
49022	38011
49022	38011
49023	38017
49023	38017
49024	38018
49024	38018
49025	38043
49025	38043
49026	38026
49026	38026
49027	38075
49027	38075
49028	38076
49028	38076
49029	38030
49029	38030
49030	38031
49030	38031
49031	38033
49031	38033
49032	38036
49032	38036
49033	38037
49033	38037
49034	38038
49034	38038
49035	38040
49035	38040
49036	38041
49036	38041
49037	38052
49037	38052
49038	38042
49038	38042
49039	38043
49039	38043
49040	38029
49040	38029
49041	38034
49041	38034
49042	38035
49042	38035
49043	38039
49043	38039
49044	38044
49044	38044
49045	38045
49045	38045
49046	38046
49046	38046
49047	38047

Intercambio	Gates
49047	38047
49048	38048
49048	38048
49049	38049
49049	38049
49050	38050
49050	38050
49051	38051
49051	38051
49052	38028
49052	38028
49053	38053
49053	38053
49054	38061
49054	38061
49055	38062
49055	38062
49056	38063
49056	38063
49057	38064
49057	38064
49058	38065
49058	38065
49059	38066
49059	38066
49061	38068
49061	38068
49062	38069
49062	38069
49063	38070
49063	38070
49064	38071
49064	38071
49066	38073
49066	38073
49067	38074
49067	38074
49068	38077
49068	38077
49069	38078
49069	38078
49071	38080
49071	38080
49072	38081
49072	38081
49073	38082
49073	38082
49074	38083
49074	38083
49075	38084
49075	38084
49077	38087
49077	38087

Intercambio	Gates
49078	38088
49078	38088
49080	38090
49080	38090
49081	38091
49081	38091
49082	38092
49082	38092
49083	38093
49083	38093
49086	38026
49086	38026
49092	38060
49092	38060
49093	38079
49093	38079
49095	38058
49095	38058
49096	38112
49096	38112
49097	38101
49097	38101
49098	38079
49098	38079
49099	38103
49099	38103
49100	38119
49100	38119
49101	38094
49101	38094
49102	38095
49102	38095
49103	38096
49103	38096
49104	38097
49104	38097
49105	38098
49105	38098
49106	38100
49106	38100
49107	38086
49107	38086
49108	38087
49108	38087
49109	38141
49109	38141
49110	38142
49110	38142
49111	38091
49111	38091
49112	38092
49112	38092
49113	38093

## Tablas de Equivalencias

Intercambio	Gates	Intercambio	Gates	Intercambio	Gates	Intercambio	Gates	Intercambio	Gates
49113	36093	49206	38106	49220	38006	49234	38147	49247	38009
49114	36115	49206	38009	49221	38120	49234	38147	49247	38139
49114	36115	49207	38107	49221	38027	49235	38148	49247	38009
49115	36116	49207	38001	49221	38120	49235	38018	49248	38169
49115	36116	49207	38107	49221	38027	49235	38148	49248	38001
49116	36118	49207	38001	49222	38121	49235	38018	49248	38169
49116	36118	49208	38108	49222	38006	49236	38132	49248	38001
49117	36117	49208	38001	49222	38121	49236	38006	49249	38170
49117	36117	49208	38108	49222	38006	49236	38132	49249	38170
49118	36156	49208	38001	49223	38123	49236	38006	49250	38137
49118	36156	49209	38109	49223	38006	49237	38134	49250	38008
49119	36152	49209	38026	49223	38123	49237	38002	49250	38137
49119	36152	49209	38109	49223	38006	49237	38134	49250	38008
49120	36153	49209	38026	49224	38124	49237	38002	49251	38135
49120	36153	49210	38130	49224	38001	49238	38146	49251	38017
49121	36154	49210	38026	49224	38124	49238	38011	49251	38135
49121	36154	49210	38130	49224	38001	49238	38146	49251	38017
49122	36155	49210	38026	49225	38125	49238	38011	49252	38145
49122	36155	49211	38111	49225	38005	49239	38152	49252	38001
49123	36157	49211	38002	49225	38125	49239	38015	49252	38145
49123	36157	49211	38111	49225	38005	49239	38152	49252	38001
49124	36099	49211	38002	49226	38126	49239	38015	49253	38150
49124	36099	49212	38112	49226	38027	49240	38153	49253	38008
49125	36168	49212	38030	49226	38126	49240	38006	49253	38150
49125	36168	49212	38112	49226	38027	49240	38153	49253	38008
49127	36173	49212	38030	49227	38127	49240	38006	49254	38162
49127	36173	49214	38118	49227	38009	49241	38173	49254	38006
49128	36205	49214	38006	49227	38127	49241	36119	49254	38162
49128	36205	49214	38118	49227	38009	49241	38173	49254	38006
49201	38101	49214	38006	49228	38128	49241	36119	49255	38168
49201	38002	49215	38113	49228	38027	49242	38140	49255	38032
49201	38101	49215	38001	49228	38128	49242	38012	49255	38168
49201	38002	49215	38113	49228	38027	49242	38140	49255	38032
49202	38102	49215	38001	49229	38129	49242	38012	49256	38163
49202	38008	49216	38115	49229	38001	49243	38155	49256	38018
49202	38102	49216	38016	49229	38129	49243	38018	49256	38163
49202	38008	49216	38115	49229	38001	49243	38155	49256	38018
49203	38103	49216	38016	49230	38130	49243	38018	49257	38161
49203	38008	49217	38117	49230	38001	49244	38171	49257	38002
49203	38103	49217	38006	49230	38130	49244	38001	49257	38161
49203	38008	49217	38117	49230	38001	49244	38171	49257	38002
49204	38122	49217	38006	49231	38133	49244	38001	49258	38164
49204	38001	49218	38115	49231	38023	49245	38104	49258	38015
49204	38122	49218	38001	49231	38133	49245	38009	49258	38164
49204	38001	49218	38115	49231	38023	49245	38104	49258	38015
49205	38105	49218	38001	49232	38138	49245	38009	49259	38165
49205	38007	49219	38119	49232	38007	49246	38167	49259	38015
49205	38001	49219	38022	49232	38138	49246	38001	49259	38165
49205	38105	49219	38119	49232	38007	49246	38009	49259	38015
49205	38007	49219	38022	49233	38131	49246	38167	49260	38166
49205	38001	49220	38114	49233	38022	49246	38001	49260	38166
49206	38106	49220	38006	49233	38131	49246	38009	49261	38143
49206	38009	49220	38114	49233	38022	49247	38139	49261	38001

## Tablas de Equivalencias

Intercambio	Gates
49261	30143
49261	30001
49262	30174
49262	30174
49263	30179
49263	30009
49263	30179
49263	30009
49264	30154
49264	36152
49264	30154
49264	36152
49265	30175
49265	30175
49266	30192
49266	36152
49266	30192
49266	36152
49267	30193
49267	36141
49267	30193
49267	36141
49268	30151
49268	36141
49268	30151
49268	36141
49269	30136
49269	30006
49269	30136
49269	30006
49270	30141
49270	30019
49270	30141
49270	30019
49271	30142
49271	30001
49271	30142
49271	30001
49272	30144
49272	30001
49272	30144
49272	30001
49273	30149
49273	30027
49273	30149
49273	30027
49274	30156
49274	30010
49274	30156
49274	30010
49275	30158
49275	30009
49275	30158

Intercambio	Gates
49275	30009
49276	30159
49276	36169
49276	30159
49276	36169
49277	30160
49277	30160
49278	30172
49278	30008
49278	30172
49278	30008
49279	30176
49279	36196
49279	30176
49279	36196
49280	30178
49280	36101
49280	30178
49280	36101
49281	30177
49281	30011
49281	30177
49281	30011
49282	30201
49282	30201
49283	30194
49283	30008
49283	30194
49283	30008
49284	30180
49284	30058
49284	30180
49284	30058
49285	30181
49285	30006
49285	30181
49285	30006
49286	30182
49286	30006
49286	30182
49286	30006
49287	30183
49287	30006
49287	30183
49287	30006
49288	30184
49288	30001
49288	30184
49288	30001
49289	30185
49289	30010
49289	30185
49289	30010

Intercambio	Gates
49290	30186
49290	30006
49290	30186
49290	30006
49291	30187
49291	30001
49291	30187
49291	30001
49292	30188
49292	30008
49292	30188
49292	30008
49293	30189
49293	30006
49293	30189
49293	30006
49294	30190
49294	30010
49294	30190
49294	30010
49295	30191
49295	30020
49295	30191
49295	30053
49295	30191
49295	30020
49295	30053
49296	30195
49296	30008
49296	30195
49296	30008
49297	30196
49297	30196
49298	30206
49298	30005
49298	30206
49298	30005
49299	30197
49299	30025
49299	30197
49299	30025
49300	30198
49300	30027
49300	30198
49300	30027
49301	30199
49301	36141
49301	30199
49301	36141
49302	30207
49302	30207
49303	30216
49303	30216
49304	30217

Intercambio	Gates
49304	30217
49305	30218
49305	30218
49306	30219
49306	30219
49307	30220
49307	30220
49308	30221
49308	30221
49309	30222
49309	30222
49310	30223
49310	30223
49311	30224
49311	30224
49312	30225
49312	30225
49313	30226
49313	30226
49314	30274
49314	30274
49315	30245
49315	30245
49316	30246
49316	30246
49317	30247
49317	30032
49317	30247
49317	30032
49318	30248
49318	30019
49318	30248
49318	30019
49319	30249
49319	30250
49320	30250
49321	30251
49321	30251
49323	30253
49323	30009
49323	30253
49323	30009
49324	30254
49324	30015
49324	30254
49324	30015
49326	30256
49326	30256
49328	30258
49328	30006
49328	30258
49328	30006

Intercambio	Gates
49329	30259
49329	30259
49330	30260
49330	30009
49330	30260
49330	30009
49331	30261
49331	30261
49332	30263
49332	30263
49333	30264
49333	30264
49334	30268
49334	30015
49334	30268
49334	30015
49335	30269
49335	30015
49335	30269
49335	30015
49336	30271
49336	30006
49336	30271
49336	30006
49337	30270
49337	30270
49338	30276
49338	30276
49339	30275
49339	30275
49340	30207
49340	30207
49341	30278
49341	30278
49342	30273
49342	30018
49342	30273
49342	30018
49343	30204
49343	30204
49344	30279
49344	30279
49345	30323
49345	30323
49346	30286
49346	30018
49346	30286
49346	30018
49347	30320
49347	30008
49347	30320
49347	30008

# Puntos importantes a tomar en cuenta en el reemplazo del Kit TCK1095 de Gates, para el Nissan Platina, Aprio, Renault Clio y Kangoo Motor 1.6Lts.

## El manual de servicio del fabricante recomienda cambiar banda de distribución a los 60.000 km.

Es importante que al cambiar la banda de distribución se utilice la herramienta especial para poder sincronizar correctamente la banda de distribución, así mismo, se recomienda el reemplazo de los principales componentes de transmisión como son; la banda, el tensor, la polea loca y el tonillo de Damper, Gates de México ofrece el kit "TCK1095", el cual incluye todos estos componentes, estas piezas tienen que ser reemplazadas al mismo tiempo al dar el servicio de mantenimiento al motor.



Fig. 1

Otro componente que debe ser reemplazado, es la bomba de agua ya que esta es movida por la banda de distribución. Cuando cambie la bomba de agua asegúrese de usar los tornillos correctos, usando el par de apriete adecuado la Fig. 2 muestra que el espacio entre el tornillo de la bomba de agua y la polea del tensor es demasiado pequeño.

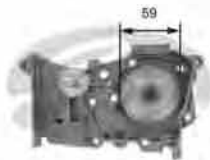

Bomba de Agua



Fig. 2

Piezas incorrectas o tornillos flojos pueden ocasionar daños al tensor, poleas y banda. Fig 3.



Fig. 3

Notemos que el sistema de distribución del Nissan Platina y el Renault Clio presentan en los engranes de los árboles de levas un fleje que al parecer viene como remachado en los engranes que representa un borde, flanco o lateral,

para evitar que la banda se salga y que hace la función de alineamiento de la banda de distribución con las demás poleas incluyendo la bomba de agua.

Este fleje o borde de los engranes de los árboles de levas recibe cargas laterales por el movimiento de la banda de distribución de acuerdo a su funcionamiento, el cual puede ocasionar que esa carga desprenda los flejes y ocasione que se traben el sistema de distribución, causando daños al motor. Es recomendable reemplazar los engranes con fleje por engranes de una sola pieza.



Flejes de los engranes del árbol de levas

Fig. 4

El tornillo del Dámper (Ref. EO 8200557644 incluido en el Kit TCK1095 de Gates) es un tonillo especial con grado de dureza 10 que debe ser reemplazado. El par de apriete correcto en este tornillo es muy importante. El apriete varía con el modelo, y código de motor, por ello recomendamos consultar el manual de usuario del fabricante del vehículo. Aplicar un incorrecto par de apriete puede llevar a que el tornillo se fracture (Fig 5).



Tornillo Fracturado

Fig. 5



# Tensores para Chevrolet / OPEL Motor 1.8 Lts.

**Referencia Gates:** TPG-14001 ó TPG-14004

**Marca de fabricante:** Chevrolet / Opel

**Modelo:** Astra, Corsa, Meriva, Tornado y

**Zafira** (Procedencia - Europa o Brasil),

**Motor:** 4Cil, 1.8Lts.

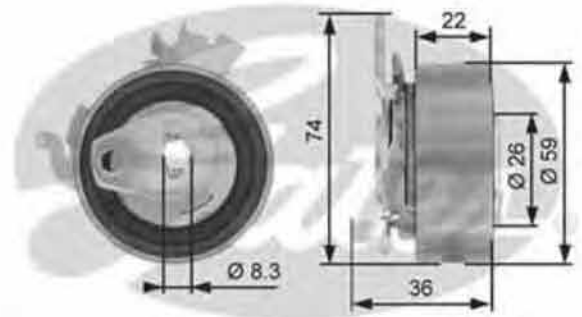

Es importante **identificar el diseño del tensor**, ya que puede variar por la procedencia y año de fabricación de los vehículos arriba mencionados.

Ambos tensores (TPG-14001 ó TPG-14004) tienen las mismas dimensiones, la diferencia radica en que el tensor TPG-14004 cuenta con una base en el buje del tensor (ver imágenes).



TPG-14001  
Ref. EO = 9158003



TPG-14004  
Ref. EO = 24426500

Ahora todo junto en un sólo  
**PAQUETE**

• Banda Micro V • Polea • Tensor



La marca de más prestigio en bandas, mangueras, hidráulica y neumática



A Tomkins Company

## FABRICANTE de Equipo Original



Poleas y Tensores  
Con la Tecnología de Gates

Su diseño de amortiguación por resorte helicoidal, único en el mercado, brinda las siguientes VENTAJAS:

-  Elimina la vibración
-  Elimina el ruido
-  Elimina el desgaste de la transmisión evitando el reemplazo constante de bandas y poleas

Gates de México, S.A. de C.V.  
Cerrada de Galeana 5  
Fracc. Ind. La Loma 54060 Tlalnepantla, Edo de México  
[www.gates.com.mx](http://www.gates.com.mx)

[www.gates.com.mx](http://www.gates.com.mx)



Gates de México, S.A. de C.V.  
Cerrada de Galeana 5  
Fracc. Ind. La Loma  
54060 Tlalnepantla, Edo. de México  
Tel. (0155) 2000 2700  
Fax. (0155) 2000 2701  
[www.gates.com.mx](http://www.gates.com.mx)



La marca de más prestigio en bandas, mangueras, hidráulica y neumática